



Laser triangulation sensor with background suppression



OBT80-R2-E0-L

- High-performance miniature photoelectric sensors
- DuraBeam Laser Sensors - durable and employable like an LED
- 45° cable outlet for maximum mounting freedom under extremely tight space constraints
- Improvement in machine availability with abrasion-resistant, antistatic glass front
- Precision object detection, almost irrespective of the color

Laser triangulation sensor with background suppression, ultra-small design with M2 mounting, 80 mm sensing range, NPN output, 2 m fixed cable



Function

The R2 series nano sensor has been developed for a broad range of applications. It offers excellent durability and is exceptionally easy to install. The housing is compact and, with its 45° cable outlet, can be installed in the smallest spaces. New functional principles and functionality open up a range of new options. The DuraBeam laser sensors are durable and can be used in the same way as a standard sensor. The abrasion-resistant lens allows long operating times close to the moving object.

Safety Information

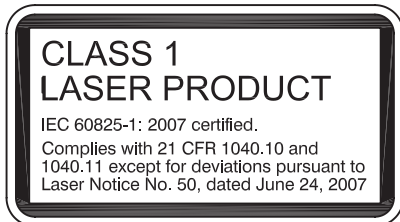

Safety Information

Laser Class 1 Information

The irradiation can lead to irritation especially in a dark environment. Do not point at people!

Maintenance and repairs should only be carried out by authorized service personnel!

Attach the device so that the warning is clearly visible and readable.

The warning accompanies the device and should be attached in immediate proximity to the device.

Caution – Use of controls or adjustments or performance of procedures other than those specified herein may result in hazardous radiation exposure.

Release date: 2021-10-27 Date of issue: 2021-10-27 Filename: 282030_eng.pdf

Refer to "General Notes Relating to Pepperl+Fuchs Product Information".

Pepperl+Fuchs Group
www.pepperl-fuchs.com

USA: +1 330 486 0001
fa-info@us.pepperl-fuchs.com

Germany: +49 621 776 1111
fa-info@de.pepperl-fuchs.com

Singapore: +65 6779 9091
fa-info@sg.pepperl-fuchs.com

PEPPERL+FUCHS

Dimensions

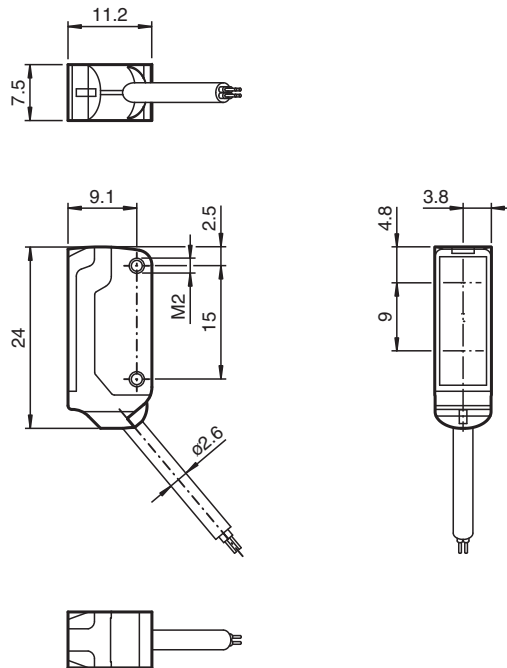

Technical Data

General specifications

Detection range	20 ... 80 mm
Reference target	standard black, 100 mm x 100 mm
Light source	laser diode
Light type	modulated visible red light , 680 nm
Laser nominal ratings	
Note	LASER LIGHT , DO NOT STARE INTO BEAM
Laser class	1
Wave length	680 nm
Beam divergence	> 5 mrad
Pulse length	approx. 3 μ s
Repetition rate	approx. 16.6 kHz
max. pulse energy	9.5 nJ
Black-white difference (6 %/90 %)	< 15 % at 80 mm
Diameter of the light spot	approx. 2 mm at a distance of 80 mm
Angle of divergence	approx. 2 °
Optical face	frontal
Ambient light limit	EN 60947-5-2 : 30000 Lux
Functional safety related parameters	
MTTF _d	800 a
Mission Time (T _M)	20 a
Diagnostic Coverage (DC)	0 %

Release date: 2021-10-27 Date of issue: 2021-10-27 Filename: 282030_eng.pdf

Refer to "General Notes Relating to Pepperl+Fuchs Product Information".

Pepperl+Fuchs Group
www.pepperl-fuchs.com

USA: +1 330 486 0001
fa-info@us.pepperl-fuchs.com

Germany: +49 621 776 1111
fa-info@de.pepperl-fuchs.com

Singapore: +65 6779 9091
fa-info@sg.pepperl-fuchs.com

 PEPPERL+FUCHS

Technical Data

Indicators/operating means		
Operation indicator		LED green, statically lit Power on , short-circuit : LED green flashing (approx. 4 Hz)
Function indicator		LED yellow: lights when object is detected
Electrical specifications		
Operating voltage	U_B	12 ... 24 V
No-load supply current	I_0	< 10 mA
Protection class		III
Output		
Switching type		NO contact
Signal output		1 NPN output, short-circuit protected, reverse polarity protected, open collector
Switching voltage		max. 30 V DC
Switching current		max. 50 mA , resistive load
Voltage drop	U_d	≤ 1.5 V DC
Switching frequency	f	approx. 2 kHz
Response time		250 μ s
Conformity		
Product standard		EN 60947-5-2
Laser safety		EN 60825-1:2007
Approvals and certificates		
EAC conformity		TR CU 020/2011
UL approval		E87056 , cULus Recognized, Class 2 Power Source
CCC approval		CCC approval / marking not required for products rated ≤ 36 V
FDA approval		IEC 60825-1:2007 Complies with 21 CFR 1040.10 and 1040.11 except for deviations pursuant to Laser Notice No. 50, dated June 24, 2007
Ambient conditions		
Ambient temperature		-20 ... 60 °C (-4 ... 140 °F)
Storage temperature		-30 ... 70 °C (-22 ... 158 °F)
Mechanical specifications		
Housing width		7.5 mm
Housing height		24 mm
Housing depth		11.2 mm
Degree of protection		IP67
Connection		2 m fixed cable
Material		
Housing		PC/ABS and TPU
Optical face		glass
Cable		PUR
Installation		Fixing screws , 2 x M2 allen head screws included with delivery
Mass		approx. 20 g
Cable length		2 m

Connection

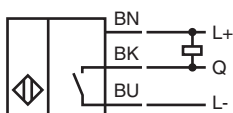

Assembly

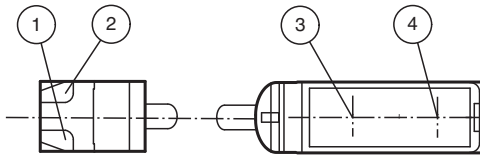

1	Operating display	green
2	Signal display	yellow
3	Emitter	
4	Receiver	

Characteristic Curve



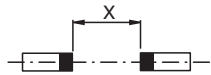
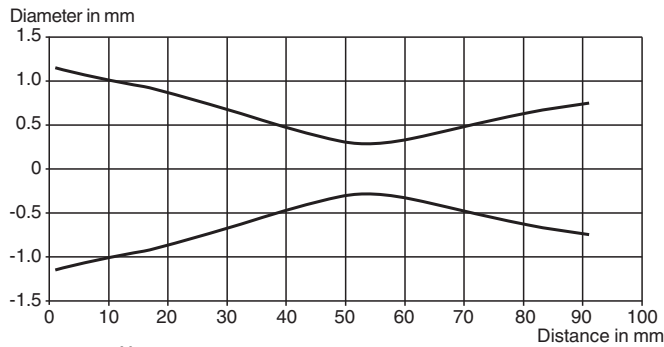

Light spot diameter

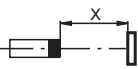
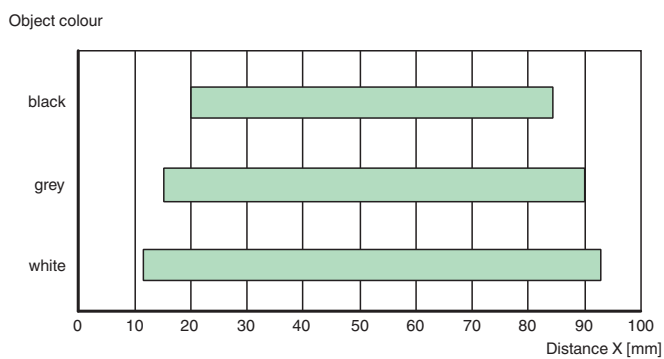

Detection ranges



Accessories

	MH-R2-01	Mounting aid for R2 series, Mounting bracket
	MH-R2-02	Mounting aid for R2 series, Mounting bracket
	MH-R2-03	Mounting aid for R2 series, Mounting bracket
	MH-R2-04	Mounting aid for R2 series, Mounting bracket

Release date: 2021-10-27 Date of issue: 2021-10-27 Filename: 282030_eng.pdf