



# Laser triangulation sensor with background suppression

## OBT80-R3-E2-0,2M-V3-L



- High-performance miniature photoelectric sensors
- DuraBeam Laser Sensors - durable and employable like an LED
- 45° cable outlet for maximum mounting freedom under extremely tight space constraints
- Improvement in machine availability with abrasion-resistant, antistatic glass front
- Precision object detection, almost irrespective of the color

Laser triangulation sensor with background suppression, ultra-small design with M3 mounting, 80 mm sensing range, PNP output, 200 mm fixed cable with plug M8, 3-pin



The R3 series nano sensor has been developed for a broad range of applications. It offers excellent durability and is exceptionally easy to install. The housing is compact and, with its 45° cable outlet, can be installed in the smallest spaces. New functional principles and functionality open up a range of new options. The DuraBeam laser sensors are durable and can be used in the same way as a standard sensor.

### Dimensions

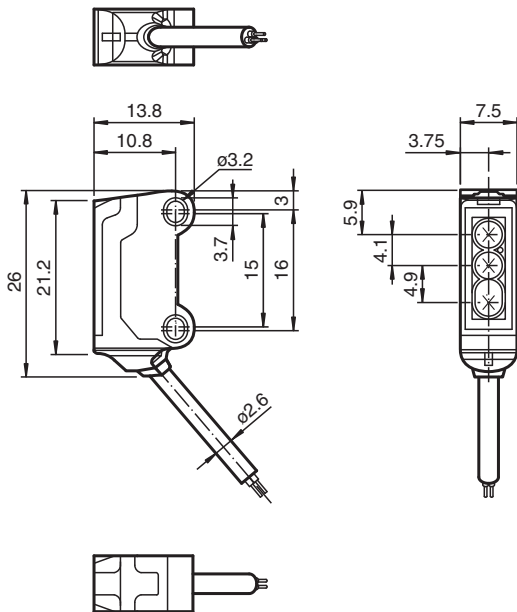

### Technical Data

General specifications	
Detection range	20 ... 80 mm
Reference target	standard black, 100 mm x 100 mm
Light source	laser diode
Light type	modulated visible red light , 680 nm
Laser nominal ratings	
Note	LASER LIGHT , DO NOT STARE INTO BEAM
Laser class	1
Wave length	680 nm
Beam divergence	> 5 mrad
Pulse length	approx. 3 µs

Release date: 2022-06-03 Date of issue: 2022-06-03 Filename: 282066\_eng.pdf

Refer to "General Notes Relating to Pepperl+Fuchs Product Information".

## Technical Data

Repetition rate		approx. 16.6 kHz
max. pulse energy		9.5 nJ
Black-white difference (6 %/90 %)		< 15 % at 80 mm
Diameter of the light spot		approx. 2 mm at a distance of 80 mm
Opening angle		approx. 2 °
Optical face		frontal
Ambient light limit		EN 60947-5-2 : 30000 Lux
<b>Functional safety related parameters</b>		
MTTF <sub>d</sub>		800 a
Mission Time (T <sub>M</sub> )		20 a
Diagnostic Coverage (DC)		0 %
<b>Indicators/operating means</b>		
Operation indicator		LED green, statically lit Power on , short-circuit : LED green flashing (approx. 4 Hz)
Function indicator		LED yellow: lights when object is detected
<b>Electrical specifications</b>		
Operating voltage	U <sub>B</sub>	12 ... 24 V
No-load supply current	I <sub>0</sub>	< 10 mA
Protection class		III
<b>Output</b>		
Switching type		NO contact
Signal output		1 PNP output, short-circuit protected, reverse polarity protected, open collector
Switching voltage		max. 30 V DC
Switching current		max. 50 mA
Voltage drop	U <sub>d</sub>	≤ 1.5 V DC
Switching frequency	f	approx. 2 kHz
Response time		250 μs
<b>Conformity</b>		
Product standard		EN 60947-5-2
Laser safety		EN 60825-1:2007
<b>Approvals and certificates</b>		
EAC conformity		TR CU 020/2011
UL approval		E87056 , cULus Recognized, Class 2 Power Source
CCC approval		CCC approval / marking not required for products rated ≤36 V
FDA approval		IEC 60825-1:2007 Complies with 21 CFR 1040.10 and 1040.11 except for deviations pursuant to Laser Notice No. 50, dated June 24, 2007
<b>Ambient conditions</b>		
Ambient temperature		-20 ... 60 °C (-4 ... 140 °F)
Storage temperature		-30 ... 70 °C (-22 ... 158 °F)
<b>Mechanical specifications</b>		
Housing width		7.5 mm
Housing height		26 mm
Housing depth		13.8 mm
Degree of protection		IP67
Connection		200 mm fixed cable with 3-pin, M8 x 1 connector
Material		
Housing		PC/ABS and TPU
Optical face		glass
Cable		PUR
Mass		approx. 10 g
Cable length		200 mm

Release date: 2022-06-03 Date of issue: 2022-06-03 Filename: 282066\_eng.pdf

Refer to "General Notes Relating to Pepperl+Fuchs Product Information".

Pepperl+Fuchs Group  
www.pepperl-fuchs.comUSA: +1 330 486 0001  
fa-info@us.pepperl-fuchs.comGermany: +49 621 776 1111  
fa-info@de.pepperl-fuchs.comSingapore: +65 6779 9091  
fa-info@sg.pepperl-fuchs.com

**PEPPERL+FUCHS**

## Connection

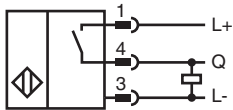

## Connection Assignment



Wire colors in accordance with EN 60947-5-2

1	BN	(brown)
3	BU	(blue)
4	BK	(black)

## Assembly

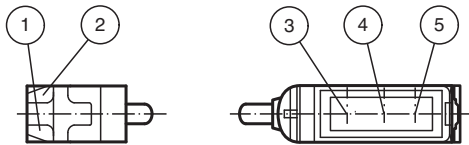

1	Operating display	green
2	Signal display	yellow
3	Emitter	
4	Receiver 1	
5	Receiver 2	

## Characteristic Curve

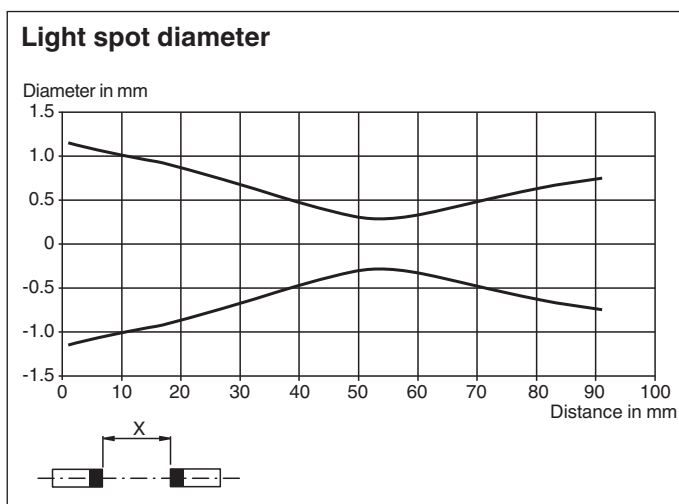

Release date: 2022-06-03 Date of issue: 2022-06-03 Filename: 282066\_eng.pdf

Refer to "General Notes Relating to Pepperl+Fuchs Product Information".

Pepperl+Fuchs Group  
www.pepperl-fuchs.com

USA: +1 330 486 0001  
fa-info@us.pepperl-fuchs.com

Germany: +49 621 776 1111  
fa-info@de.pepperl-fuchs.com

Singapore: +65 6779 9091  
fa-info@sg.pepperl-fuchs.com



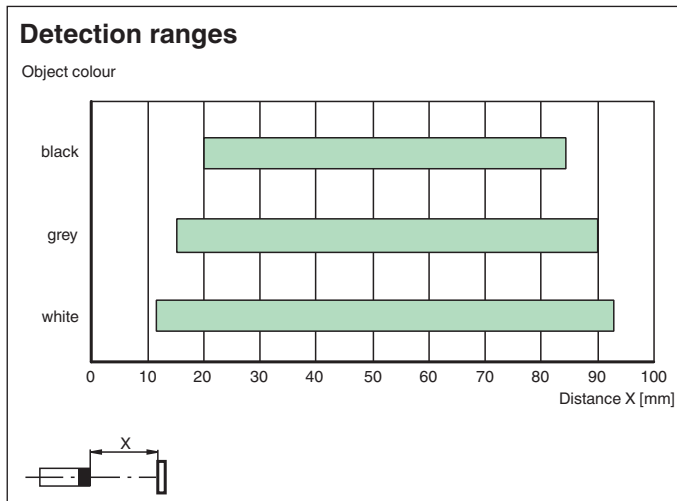

## Characteristic Curve

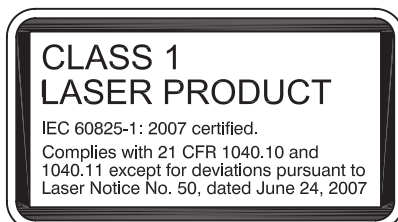

## Safety Information



## Accessories

	<b>V3-WM-2M-PUR</b>	Female cordset single-ended M8 angled A-coded, 3-pin, PUR cable grey
	<b>MH-R3-01</b>	Mounting aid for sensors from the R3 series, mounting bracket
	<b>MH-R3-02</b>	Mounting aid for sensors from the R3 series, mounting bracket
	<b>MH-R3-03</b>	Mounting aid for sensors from the R3 series, mounting bracket

## Accessories

	<b>MH-R3-04</b>	Mounting aid for sensors from the R3 series, mounting bracket
---	-----------------	---