



## Inductive sensor NBN3-F31-Z8-V18

- Direct mounting on standard actuators
- Fixed setting



### Dimensions

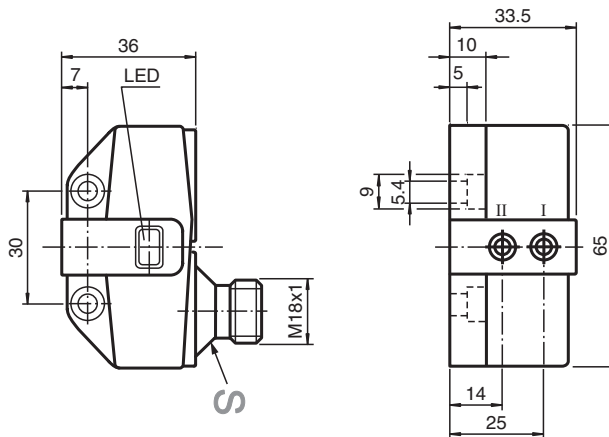

### Technical Data

General specifications		
Switching function		2 x normally open (NO)
Output type		Two-wire
Rated operating distance	$s_n$	3 mm
Installation		flush mountable
Output polarity		DC
Assured operating distance	$s_a$	0 ... 2.43 mm
Actual operating distance	$s_r$	2.7 ... 3.3 mm typ. 3 mm
Reduction factor $r_{AI}$		0.5
Reduction factor $r_{Cu}$		0.4
Reduction factor $r_{304}$		1
Reduction factor $r_{St37}$		1.1
Output type		4-wire
Nominal ratings		
Operating voltage	$U_B$	6 ... 60 V DC
Switching frequency	$f$	0 ... 500 Hz
Hysteresis	$H$	typ. 5 %

Release date: 2022-05-23 Date of issue: 2022-05-23 Filename: 282688\_eng.pdf

Refer to "General Notes Relating to Pepperl+Fuchs Product Information".

Pepperl+Fuchs Group  
www.pepperl-fuchs.com

USA: +1 330 486 0001  
fa-info@us.pepperl-fuchs.com

Germany: +49 621 776 1111  
fa-info@de.pepperl-fuchs.com

Singapore: +65 6779 9091  
fa-info@sg.pepperl-fuchs.com

**PF** PEPPERL+FUCHS

## Technical Data

Reverse polarity protection		reverse polarity tolerant
Short-circuit protection		pulsing
Voltage drop	$U_d$	$\leq 5.5$ V
Operating current	$I_L$	4 ... 100 mA
Lowest operating current	$I_m$	4 mA
Off-state current	$I_r$	0.5 ... 0.9 mA typ. 0.65 mA
Time delay before availability	$t_v$	$\leq 40$ ms
Switching state indicator		LED, yellow
<b>Limit data</b>		
Tightening torque, fastening screws		0.4 Nm
<b>Functional safety related parameters</b>		
MTTF <sub>d</sub>		570 a
Mission Time (T <sub>M</sub> )		20 a
Diagnostic Coverage (DC)		0 %
<b>Compliance with standards and directives</b>		
Standard conformity		
Standards		EN 60947-5-2:2007 EN 60947-5-2/A1:2012 IEC 60947-5-2:2007 IEC 60947-5-2 AMD 1:2012
<b>Approvals and certificates</b>		
UL approval		cULus Listed, General Purpose, Class 2 Power Source
CCC approval		Certified by China Compulsory Certification (CCC)
<b>Ambient conditions</b>		
Ambient temperature		-25 ... 70 °C (-13 ... 158 °F)
<b>Mechanical specifications</b>		
Connection type		Connector plug M18 x 1 , 4-pin
Housing material		PBT
Sensing face		PBT
Degree of protection		IP67
Mass		94 g
Tightening torque, fastening screws		4 Nm ... 5 Nm

## Connection

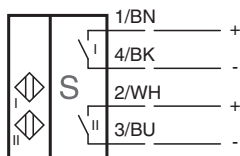

## Connection Assignment

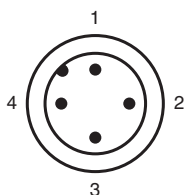







## Connection Assignment

Wire colors in accordance with EN 60947-5-2

1	BN	(brown)
2	WH	(white)
3	BU	(blue)
4	BK	(black)

## Accessories

	<b>BT65A</b>	Activator for F31 series
	<b>BT65B</b>	Activator for F31 series
	<b>BT65X</b>	Activator for F31 series
	<b>BT115A</b>	Activator for F31 series
	<b>BT115B</b>	Activator for F31 series
	<b>V18-G</b>	Cable socket in M18 format, ready for make up
	<b>V18-W</b>	Cable socket in M18 format, ready for make up

Release date: 2022-05-23 Date of issue: 2022-05-23 Filename: 282688\_eng.pdf

Refer to "General Notes Relating to Pepperl+Fuchs Product Information".