

# Current/Voltage Trip Value

## KFD2-GS-1.2W

- 1-channel signal conditioner
- 24 V DC supply (Power Rail)
- Current and voltage input
- 2 relay contact outputs
- Programmable high/low alarm
- Configurable via DIP switches and potentiometer
- Terminal blocks with test sockets



### Function

This signal conditioner provides the galvanic isolation between field circuits and control circuits. The device is a trip amplifier with two trip points. Trip points, hysteresis and mode of operation can be set independently for both relay outputs. 0/4 mA ... 20 mA-, 0/1 V ... 5 V- or 0/2 V ... 10 V signals can be connected at the input. The device actuates the relay output when it reaches the adjusted trip points. The device is easily configured by the use of DIP switches and potentiometers.

### Connection

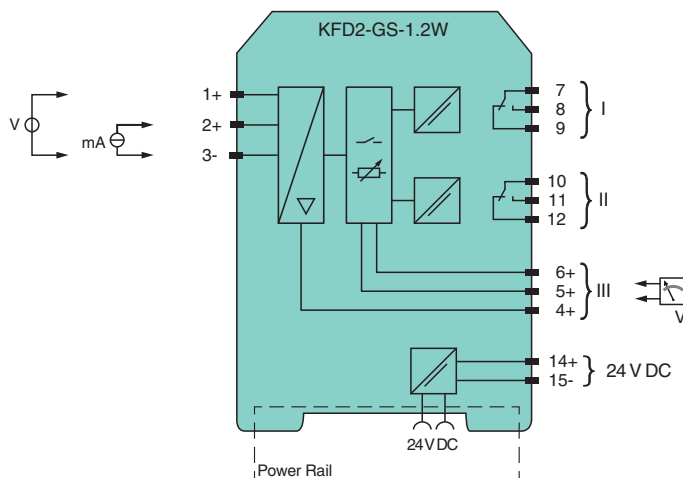

### Technical Data

#### General specifications

Signal type	Analog input		
<b>Supply</b>			
Connection	Power Rail or terminals 14+, 15-		
Rated voltage	$U_r$	20 ... 30 V DC	
Rated current	$I_r$	< 50 mA	
Power consumption	< 1.5 W		
<b>Input</b>			
Connection side	field side		
Measurement range	terminals 1+, 3-: voltage 0/1 ... 5 V, load $\geq 50 \text{ k}\Omega$ or voltage 0/2 ... 10 V, load $\geq 100 \text{ k}\Omega$ terminals 2+, 3-: current 0/4 ... 20 mA ; load $\leq 50 \Omega$		

Release date: 2021-12-10 Date of issue: 2021-12-10 Filename: 292461\_eng.pdf

Refer to "General Notes Relating to Pepperl+Fuchs Product Information".

Pepperl+Fuchs Group  
www.pepperl-fuchs.com

USA: +1 330 486 0002  
pa-info@us.pepperl-fuchs.com

Germany: +49 621 776 2222  
pa-info@de.pepperl-fuchs.com

Singapore: +65 6779 9091  
pa-info@sg.pepperl-fuchs.com

**PEPPERL+FUCHS**

## Technical Data





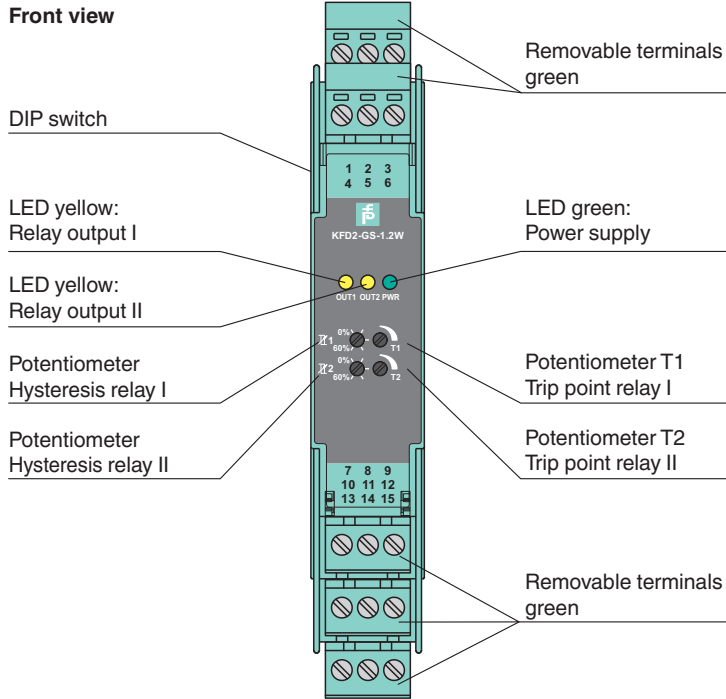

Output	
Connection side	control side
Output I, II	terminals 7, 8, 9; 10, 11, 12
Contact loading	250 V AC / 4 A / $\cos \phi > 0.7$ ; 40 V DC / 2 A resistive load
Output III	device configuration : terminals 4, 5, 6
Transfer characteristics	
Deviation	$\leq 1 \%$
Influence of ambient temperature	0.01 % / K of adjusted trip value
Input delay	200 ms
Galvanic isolation	
Input/power supply	reinforced insulation according to IEC/EN 61010-1, rated insulation voltage 300 V <sub>eff</sub>
Input/output I, II	reinforced insulation according to IEC/EN 61010-1, rated insulation voltage 300 V <sub>eff</sub>
Output I, II/power supply	reinforced insulation according to IEC/EN 61010-1, rated insulation voltage 300 V <sub>eff</sub>
Indicators/settings	
Display elements	LEDs
Control elements	DIP switch potentiometer
Configuration	via DIP switches via potentiometer
Labeling	space for labeling at the front
Directive conformity	
Electromagnetic compatibility	
Directive 2014/30/EU	EN 61326-1:2013 (industrial locations)
Low voltage	
Directive 2014/35/EU	EN 61010-1:2010
Conformity	
Degree of protection	IEC 60529
Protection against electrical shock	EN 61010-1:2010
Ambient conditions	
Ambient temperature	-20 ... 60 °C (-4 ... 140 °F) extended ambient temperature range up to 70 °C (158 °F), refer to manual for necessary mounting conditions
Mechanical specifications	
Degree of protection	IP20
Connection	screw terminals
Mass	approx. 120 g
Dimensions	20 x 124 x 115 mm (0.8 x 4.9 x 4.5 inch) (W x H x D) , housing type B2
Mounting	on 35 mm DIN mounting rail acc. to EN 60715:2001
General information	
Supplementary information	Observe the certificates, declarations of conformity, instruction manuals, and manuals where applicable. For information see <a href="http://www.pepperl-fuchs.com">www.pepperl-fuchs.com</a> .

Release date: 2021-12-10 Date of issue: 2021-12-10 Filename: 292461\_eng.pdf



## Assembly



## Matching System Components

	<b>KFD2-EB2</b>	Power Feed Module
	<b>UPR-03</b>	Universal Power Rail with end caps and cover, 3 conductors, length: 2 m
	<b>UPR-03-M</b>	Universal Power Rail with end caps and cover, 3 conductors, length: 1,6 m
	<b>UPR-03-S</b>	Universal Power Rail with end caps and cover, 3 conductors, length: 0.8 m
	<b>K-DUCT-GY</b>	Profile rail, wiring comb field side, gray
	<b>K-DUCT-GY-UPR-03</b>	Profile rail with UPR-03-* insert, 3 conductors, wiring comb field side, gray

## Accessories

	<b>KF-ST-5GN</b>	Terminal block for KF modules, 3-pin screw terminal, green
	<b>KF-CP</b>	Red coding pins, packaging unit: 20 x 6

Release date: 2021-12-10 Date of issue: 2021-12-10 Filename: 292461\_eng.pdf

**Additional Information**

**Function**

**Internal signal voltage**

The device converts the input signals at terminals 1, 2, and 3 into a proportional internal voltage  $U_{int}$  between 0 V and 10 V. This conversion allows reaction-free verification of the input signal. The voltage is output at terminals 4+ and 3-.

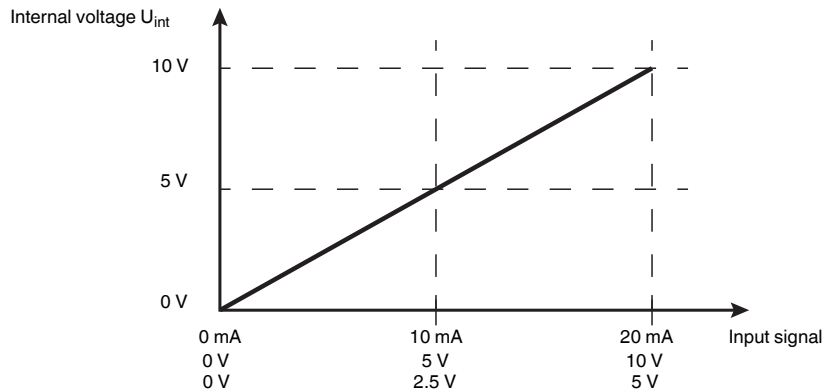

**Trip points**

The potentiometers T1 and T2 convert the set trip points into a proportional switching voltage  $U_{pot}$  between 0 V and 10 V. The voltage range corresponds to a range of 0 % to 100 %. This voltage can be measured at terminals 3, 5, and 6.

- Relay output I: Terminals 5+, 3-
- Relay output II: Terminals 6+, 3-

The trip point, hysteresis, mode of operation and type of alarm (high or low alarm) can be selected for each relay.

High alarm means that the switching state of the relay changes when the set trip point is exceeded. This state comes to an end if the value falls below a lower limit. The difference between these two values corresponds to the hysteresis, which can be set on the front panel. With a low alarm, the alarm signal is output at values below the trip point.

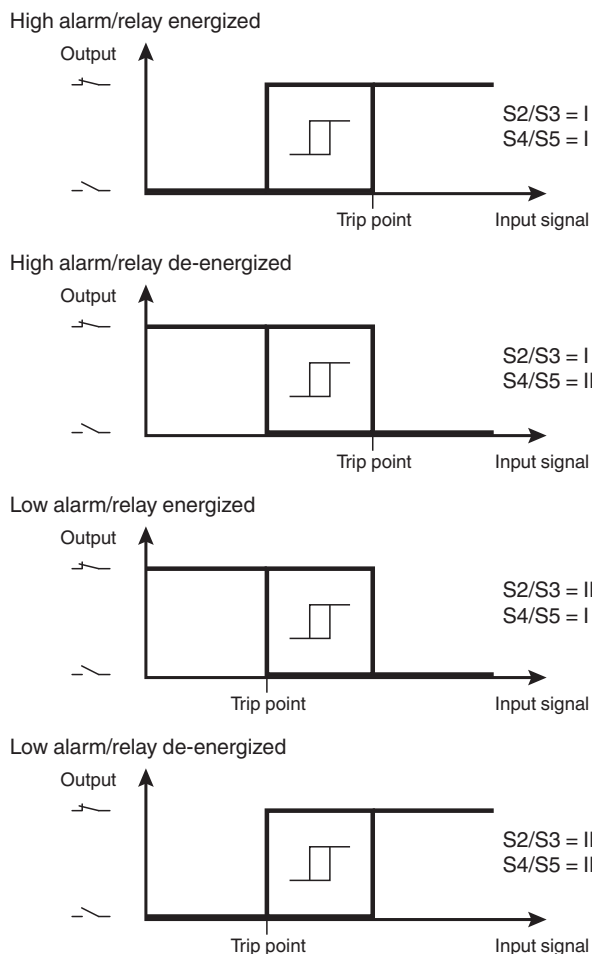

Release date: 2021-12-10 Date of issue: 2021-12-10 Filename: 292461\_eng.pdf

Refer to "General Notes Relating to Pepperl+Fuchs Product Information".

**Configuration**

**DIP switch function**

Set the DIP switch according to the required function.

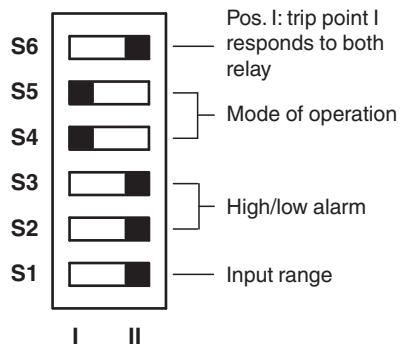

Switch	Position	Function
S6	I	Trip point I addresses both relay
	II	Relay I independent of relay II
S5	I	Relay II energized in case of alarm
	II	Relay II de-energized in case of alarm
S4	I	Relay I energized in case of alarm
	II	Relay I de-energized in case of alarm
S3	I	High alarm relay II
	II	Low alarm relay II
S2	I	High alarm relay I
	II	Low alarm relay I
S1	I	Input ranges 0/1 V to 5 V or 0/4 mA to 20 mA
	II	Input ranges 0/2 V to 10 V or 0/4 mA to 20 mA

**Setting the trip points with no input signal**

The trip points can be set using the potentiometers T1 and T2 and the proportional switching voltage  $U_{pot}$  at terminals 5+, 3- (relay I) and terminals 6+, 3- (relay II). This is done using a voltage meter (measuring range 10 V). There must be no input signal at this point. Select the trip points in the unit of the input signal or in %.

**Input signal in mA, trip point TP in mA**

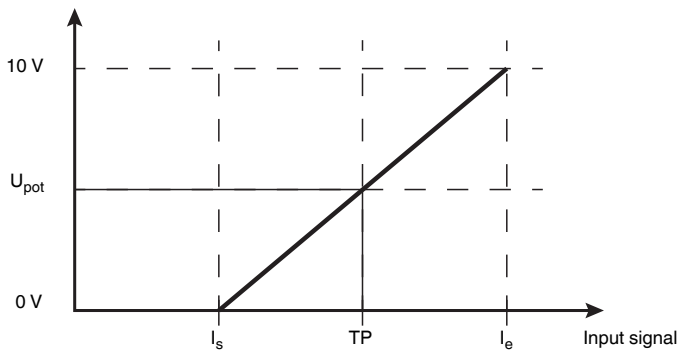

$I_s$  = Starting point  
 TP = Trip point  
 $I_e$  = End point  
 $U_{pot}$  = Proportional switching voltage

The proportional switching voltage  $U_{pot}$  is calculated using the following formula:

$$U_{pot} = 10 \text{ V} \times (TP - I_s) / (I_e - I_s)$$

**Example:**

Trip point TP: 13 mA  
 $I_s$ : 4 mA  
 $I_e$ : 20 mA

$$U_{pot} = 10 \text{ V} \times (13 \text{ mA} - 4 \text{ mA}) / (20 \text{ mA} - 4 \text{ mA}) = 5.6 \text{ V}$$

**Input signal in mA, trip point TP in %**

The proportional switching voltage  $U_{pot}$  is calculated using the following formula:

$$U_{pot} = 1 \text{ V} / 2 \text{ mA} \times (TP / 100 \times (I_e - I_s) + I_s)$$

**Example:**

Trip point TP: 75 %  
 $I_s$ : 4 mA  
 $I_e$ : 20 mA

$$U_{pot} = 1 \text{ V} / 2 \text{ mA} \times (75 \% / 100 \% \times (20 \text{ mA} - 4 \text{ mA}) + 4 \text{ mA}) = 8 \text{ V}$$

Release date: 2021-12-10 Date of issue: 2021-12-10 Filename: 292461\_eng.pdf

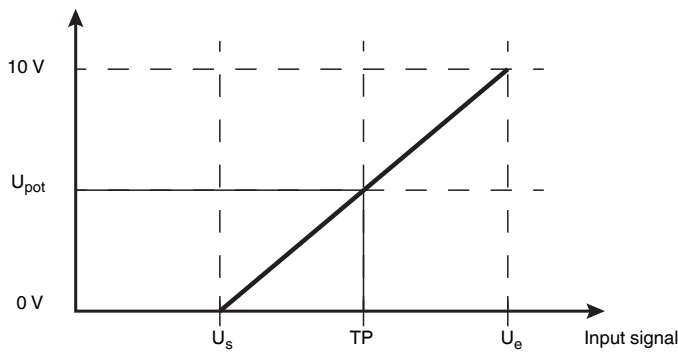
**Input signal in V, trip point TP in V**

$U_s$  = Starting point  
 $TP$  = Trip point  
 $U_e$  = End point  
 $U_{pot}$  = Proportional switching voltage

The proportional switching voltage  $U_{pot}$  is calculated using the following formula:

$$U_{pot} = 10 \text{ V} \times (TP - U_s) / (U_e - U_s)$$

**Example:**

Trip point TP: 7 V

$U_s$ : 2 V

$U_e$ : 10 V

$$U_{pot} = 10 \text{ V} \times (7 \text{ V} - 2 \text{ V}) / (10 \text{ V} - 2 \text{ V}) = 6.25 \text{ V}$$

**Input signal in V, trip point TP in %**

The proportional switching voltage  $U_{pot}$  is calculated using the following formula:

$$U_{pot} = TP / 100 \times (U_e - U_s) + U_s$$

**Example:**

Trip point TP: 45 %

$U_s$ : 2 V

$U_e$ : 10 V

$$U_{pot} = 45 \% / 100 \% \times (10 \text{ V} - 2 \text{ V}) + 2 \text{ V} = 5.6 \text{ V}$$

**Setting the trip points with an input signal**

The trip points can be adjusted to the input signal using potentiometers T1 and T2. No measuring device is required.

**For low alarm:**

1. Turn the potentiometer counterclockwise as far as it will go to the left (15 turns).
2. Turn the potentiometer clockwise until the output is tripped. Each turn changes the trip point by about 7 %.
3. Set the hysteresis. This does not change the trip point.

**For high alarm:**

1. Turn the potentiometer clockwise as far as it will go to the right (15 turns)
2. Turn the potentiometer counterclockwise until the output is tripped. Each turn changes the trip point by around 7 %.
3. Set the hysteresis. This does not change the trip point.