



## Retroreflective sensor with polarization filter



### OBR15M-R200-2EP-IO-0,3M-V15

- Medium design with versatile mounting options
- Extended temperature range  
-40 °C ... 60 °C
- High degree of protection IP69K
- IO-Link interface for service and process data

Retroreflective sensor with polarization filter



### Function

The optical sensors in the series are the first devices to offer an end-to-end solution in a medium-sized standard design – from the thru-beam sensor through to the measuring distance sensor. As a result of this design, the sensors are able to perform practically all standard automation tasks.

The entire series enables sensors to communicate via IO-Link.

The DuraBeam laser sensors are durable and can be used in the same way as a standard sensor.

Multi Pixel Technology (MPT) ensures that the standard sensors are flexible and can be adapted to the application environment.

### Dimensions

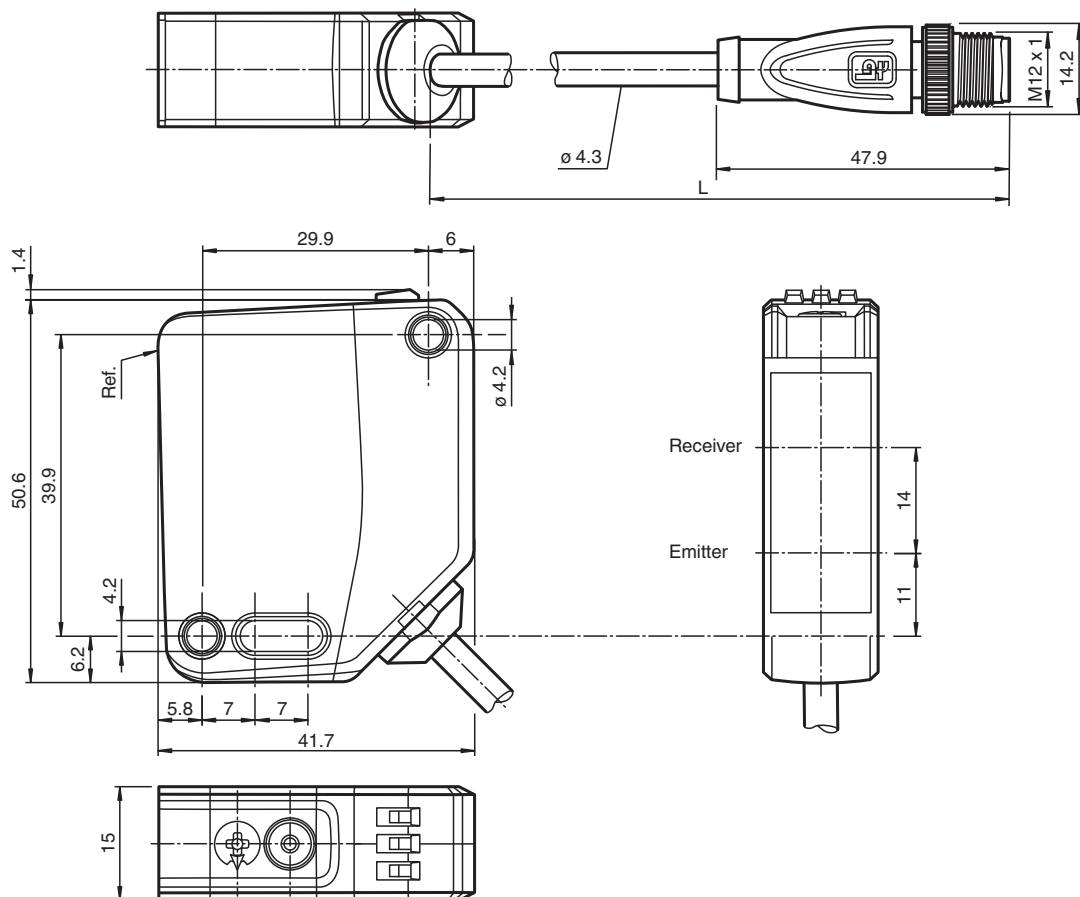

Release date: 2023-05-09 Date of issue: 2023-05-09 Filename: 2955670-100015\_eng.pdf

Refer to "General Notes Relating to Pepperl+Fuchs Product Information".

Pepperl+Fuchs Group  
www.pepperl-fuchs.com

USA: +1 330 486 0001  
fa-info@us.pepperl-fuchs.com

Germany: +49 621 776 1111  
fa-info@de.pepperl-fuchs.com

Singapore: +65 6779 9091  
fa-info@sg.pepperl-fuchs.com

**PEPPERL+FUCHS**

## Technical Data

| General specifications               |                |   |
|--------------------------------------|----------------|---|
| Effective detection range            |                | 0 ... 15 m  |
| Reflector distance                   |                | 0.02 ... 15 m   |
| Threshold detection range            |                | 18.5 m  |
| Reference target                     |                | H85-2 reflector   |
| Light source                         |                | LED   |
| Light type                           |                | modulated visible red light   |
| LED risk group labelling             |                | exempt group  |
| Polarization filter                  |                | yes   |
| Diameter of the light spot           |                | approx. 520 mm at a distance of 15 m  |
| Opening angle                        |                | 2 °   |
| Ambient light limit                  |                | EN 60947-5-2 : 60000 Lux  |
| Functional safety related parameters |                |   |
| MTTF <sub>d</sub>                    |                | 724 a   |
| Mission Time (T <sub>M</sub> )       |                | 20 a  |
| Diagnostic Coverage (DC)             |                | 60 %  |
| Indicators/operating means           |                |   |
| Operation indicator                  |                | LED green:<br>constantly on - power on<br>flashing (4Hz) - short circuit<br>flashing with short break (1 Hz) - IO-Link mode   |
| Function indicator                   |                | Yellow LED:<br>Permanently lit - light path clear<br>Permanently off - object detected<br>Flashing (4 Hz) - insufficient operating reserve  |
| Control elements                     |                | Light-on/dark-on changeover switch  |
| Control elements                     |                | sensitivity adjustment  |
| Electrical specifications            |                |   |
| Operating voltage                    | U <sub>B</sub> | 10 ... 30 V DC  |
| Ripple                               |                | max. 10 %   |
| No-load supply current               | I <sub>0</sub> | < 18 mA at 24 V Operating voltage   |
| Protection class                     |                | III   |
| Interface                            |                |   |
| Interface type                       |                | IO-Link ( via C/Q = pin 4 )   |
| IO-Link revision                     |                | 1.1   |
| Device profile                       |                | Identification and diagnosis<br>Smart Sensor type 2.4   |
| Device ID                            |                | 0x111203 (1118723)  |
| Transfer rate                        |                | COM2 (38.4 kBit/s)  |
| Min. cycle time                      |                | 2.3 ms  |
| Process data width                   |                | Process data input 2 Bit<br>Process data output 2 Bit   |
| SIO mode support                     |                | yes   |
| Compatible master port type          |                | A   |
| Input                                |                |   |
| Test input                           |                | emitter deactivation at +U <sub>B</sub>   |
| Output                               |                |   |
| Switching type                       |                | The switching type of the sensor is adjustable. The default setting is:<br>C/Q - Pin4: NPN normally open / dark-on, PNP normally closed / light-on, IO-Link<br>/Q - Pin2: NPN normally closed / light-on, PNP normally open / dark-on |
| Signal output                        |                | 2 push-pull (4 in 1) outputs, short-circuit protected, reverse polarity protected,<br>overvoltage protected   |
| Switching voltage                    |                | max. 30 V DC  |
| Switching current                    |                | max. 100 mA , resistive load  |
| Usage category                       |                | DC-12 and DC-13   |
| Voltage drop                         | U <sub>d</sub> | ≤ 1.5 V DC  |
| Switching frequency                  | f              | 1000 Hz   |

Release date: 2023-05-09 Date of issue: 2023-05-09 Filename: 295670-100015\_eng.pdf

Refer to "General Notes Relating to Pepperl+Fuchs Product Information".

 Pepperl+Fuchs Group  
www.pepperl-fuchs.com

 USA: +1 330 486 0001  
fa-info@us.pepperl-fuchs.com

 Germany: +49 621 776 1111  
fa-info@de.pepperl-fuchs.com

 Singapore: +65 6779 9091  
fa-info@sg.pepperl-fuchs.com

 **PEPPERL+FUCHS**

## Technical Data

|                                   |   |
|-----------------------------------|---|
| Response time                     | 0.5 ms  |
| <b>Conformity</b>                 |   |
| Communication interface           | IEC 61131-9   |
| Product standard                  | EN 60947-5-2  |
| <b>Approvals and certificates</b> |   |
| UL approval                       | E87056 , cULus Listed , class 2 power supply , type rating 1  |
| CCC approval                      | CCC approval / marking not required for products rated ≤36 V  |
| <b>Ambient conditions</b>         |   |
| Ambient temperature               | -40 ... 60 °C (-40 ... 140 °F) , fixed cable<br>-20 ... 60 °C (-4 ... 140 °F) , movable cable not appropriate for conveyor chains |
| Storage temperature               | -40 ... 70 °C (-40 ... 158 °F)  |
| <b>Mechanical specifications</b>  |   |
| Housing width                     | 15 mm   |
| Housing height                    | 50.6 mm   |
| Housing depth                     | 41.7 mm   |
| Degree of protection              | IP67 / IP69 / IP69K   |
| Connection                        | 300 mm fixed cable with plug, M12 x 1, 5 pin  |
| <b>Material</b>                   |   |
| Housing                           | PC (Polycarbonate)  |
| Optical face                      | PMMA  |
| Mass                              | approx. 45 g  |
| Cable length                      | 0.3 m   |

## Connection

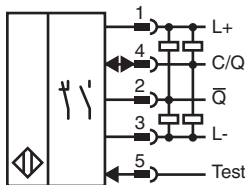

## Connection Assignment

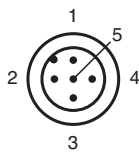

Wire colors in accordance with EN 60947-5-2

|   |    |         |
|---|----|---------|
| 1 | BN | (brown) |
| 2 | WH | (white) |
| 3 | BU | (blue)  |
| 4 | BK | (black) |
| 5 | GY | (gray)  |

**Assembly**

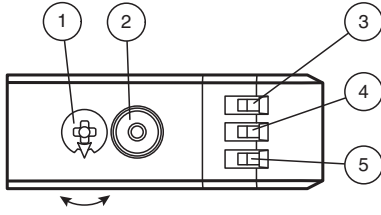

|   |                                      |    |
|---|--------------------------------------|----|
| 1 | Sensitivity adjustment               |    |
| 2 | Light-on / dark-on changeover switch |    |
| 3 | Operating indicator / dark on        | GN |
| 4 | Signal indicator                     | YE |
| 5 | Operating indicator / light on       | GN |

**Characteristic Curve**

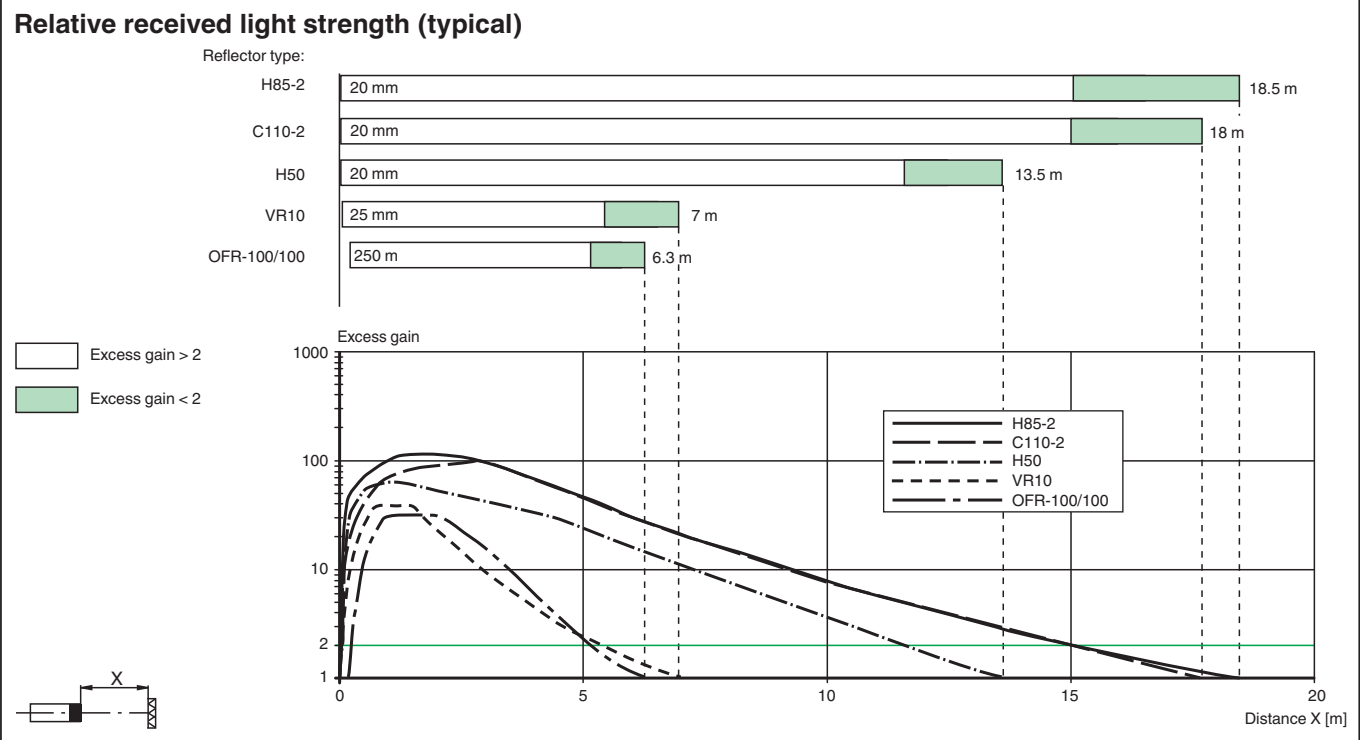
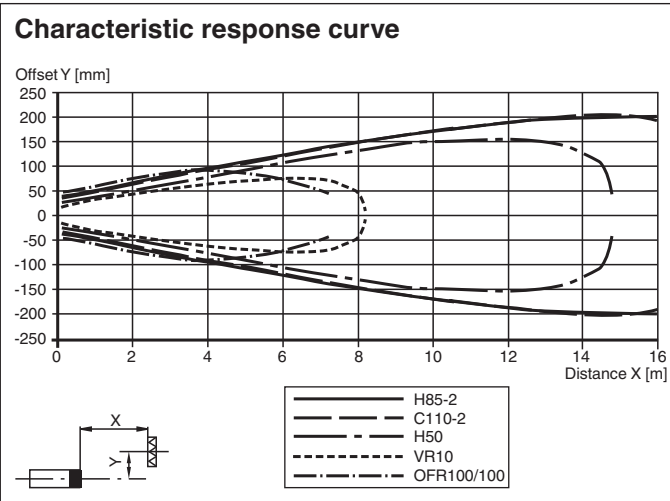

**Commissioning**

To unlock the adjustment functions turn the sensing range / sensitivity adjuster for more than 180 degrees.

**Sensing Range / Sensitivity**

Turn sensing range / sensitivity adjuster clockwise to increase sensing range / sensitivity.  
 Turn sensing range / sensitivity adjuster counter clockwise to decrease sensing range / sensitivity.  
 If the end of the adjustment range is reached, the signal indicator starts flashing with 8 Hz.

**Light-on / Dark-on Configuration**

Press the light-on / dark-on changeover switch for more than 1 second (less than 4 seconds). The light-on / dark-on mode changes and the operating indicators are activated accordingly.

Release date: 2023-05-09 Date of issue: 2023-05-09 Filename: 295670-100015\_eng.pdf

## Commissioning



















If you press the light-on / dark-on changeover switch for more than 4 seconds, the light-on / dark-on mode changes back to the original setting. On release of the light-on / dark-on changeover switch the current state is activated.

### Restore Factory Settings

Press the light-on / dark-on changeover switch for more than 10 seconds (less than 30 seconds) until all LEDs turn off. On release of the light-on / dark-on changeover switch the signal indicator turns on. After 5 seconds the sensor resumes operation with factory default settings.

After 5 minutes of inactivity the sensing range / sensitivity adjustment is locked. In order to reactivate the sensing range / sensitivity adjustment, turn the sensing range / sensitivity adjuster for more than 180 degrees.

## Accessories

|   |                             |   |
|---|-----------------------------|---|
|    | <b>V15-W-2M-PUR</b>         | Female cordset single-ended M12 angled A-coded, 5-pin, PUR cable grey         |
|    | <b>V15-G-2M-PUR</b>         | Female cordset single-ended M12 straight A-coded, 5-pin, PUR cable grey       |
|    | <b>REF-H85-2</b>            | Reflector, rectangular 84.5 mm x 84.5 mm, mounting holes                      |
|    | <b>REF-C110-2</b>           | Reflector, round ø 84 mm, central mounting hole                               |
|    | <b>REF-H50</b>              | Reflector, rectangular 51 mm x 61 mm, mounting holes, fixing strap            |
|    | <b>REF-VR10</b>             | Reflector, rectangular 60 mm x 19 mm, mounting holes                          |
|  | <b>OFR-100/100</b>          | Reflective tape 100 mm x 100 mm   |
|  | <b>V1-G-2M-PUR</b>          | Female cordset single-ended M12 straight A-coded, 4-pin, PUR cable grey       |
|  | <b>V1-W-2M-PUR</b>          | Female cordset single-ended M12 angled A-coded, 4-pin, PUR cable grey         |
|  | <b>OMH-MLV12-HWG</b>        | Mounting bracket for series MLV12 sensors                                     |
|  | <b>OMH-R200-01</b>          | Mounting aid for round steel ø 12 mm or sheet 1.5 mm ... 3 mm                 |
|  | <b>OMH-MLV12-HWK</b>        | Mounting bracket for series MLV12 sensors                                     |
|  | <b>OMH-R20x-Quick-Mount</b> | Quick mounting accessory  |
|  | <b>ICE2-8IOL-G65L-V1D</b>   | EtherNet/IP IO-Link master with 8 inputs/outputs                              |
|  | <b>ICE3-8IOL-G65L-V1D</b>   | PROFINET IO IO-Link master with 8 inputs/outputs                              |
|  | <b>ICE2-8IOL-K45S-RJ45</b>  | EtherNet/IP IO-Link master with 8 inputs/outputs, DIN rail, screw terminal    |
|  | <b>ICE3-8IOL-K45P-RJ45</b>  | PROFINET IO IO-Link master with 8 inputs/outputs, DIN rail, push-in terminals |
|  | <b>ICE3-8IOL-K45S-RJ45</b>  | PROFINET IO IO-Link master with 8 inputs/outputs, DIN rail, screw terminal    |

Release date: 2023-05-09 Date of issue: 2023-05-09 Filename: 295670-100015\_eng.pdf

Refer to "General Notes Relating to Pepperl+Fuchs Product Information".

Pepperl+Fuchs Group  
www.pepperl-fuchs.com





USA: +1 330 486 0001  
fa-info@us.pepperl-fuchs.com

Germany: +49 621 776 1111  
fa-info@de.pepperl-fuchs.com

Singapore: +65 6779 9091  
fa-info@sg.pepperl-fuchs.com

 **PEPPERL+FUCHS**

## Accessories

|   |                             |  |
|---|-----------------------------|--|
|  | <b>IO-Link-Master02-USB</b> | IO-Link master, supply via USB port or separate power supply, LED indicators, M12 plug for sensor connection |
|  | <b>ICE1-8IOL-G30L-V1D</b>   | Ethernet IO-Link module with 8 inputs/outputs  |
|  | <b>ICE1-8IOL-G60L-V1D</b>   | Ethernet IO-Link module with 8 inputs/outputs  |
|  | <b>ICE2-8IOL-K45P-RJ45</b>  | EtherNet/IP IO-Link master with 8 inputs/outputs, DIN rail, push-in connectors                               |