

Ultrasonic sensor

UC4000-L2M-E7-T-2M



- Extended temperature range
- Cable connection
- Rugged metal base
- Sensor head bidirectional and rotatable
- Function indicators visible from all directions
- Selectable sound lobe width
- Programmable

Single head system



Dimensions

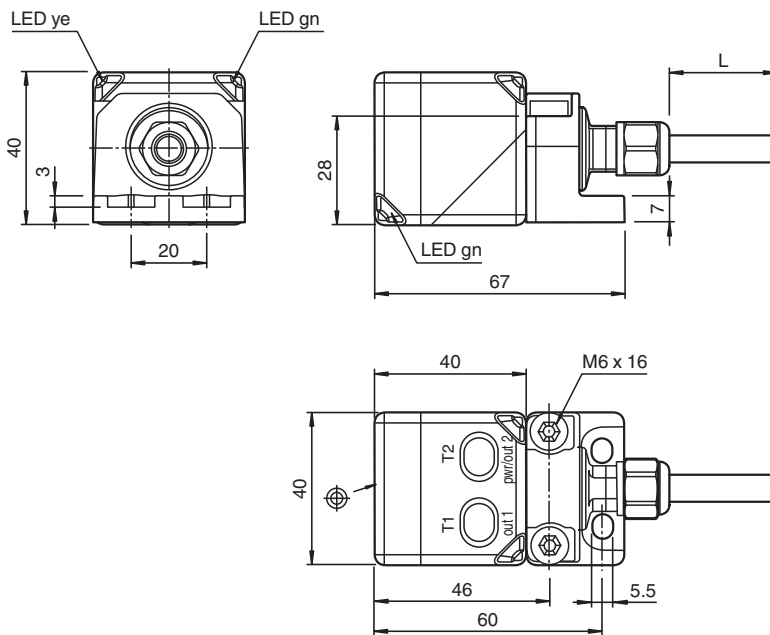

Technical Data

General specifications

Sensing range	200 ... 4000 mm
Adjustment range	240 ... 4000 mm
Dead band	0 ... 200 mm
Standard target plate	100 mm x 100 mm
Transducer frequency	approx. 85 kHz

Nominal ratings

Response delay	minimum: 110 ms factory setting: 280 ms
Time delay before availability	t_v ≤ 1600 ms

Release date: 2022-11-23 Date of issue: 2022-11-23 Filename: 299135_eng.pdf

Refer to "General Notes Relating to Pepperl+Fuchs Product Information".

Pepperl+Fuchs Group
www.pepperl-fuchs.com

USA: +1 330 486 0001
fa-info@us.pepperl-fuchs.com

Germany: +49 621 776 1111
fa-info@de.pepperl-fuchs.com

Singapore: +65 6779 9091
fa-info@sg.pepperl-fuchs.com

pepperl+fuchs

Technical Data

Indicators/operating means		
LED green		Operating display
LED yellow 1		switching state switch output 1
LED yellow 2		switching state switch output 2
LED red		error
Electrical specifications		
Operating voltage	U_B	10 ... 30 V DC , ripple 10 % _{SS}
No-load supply current	I_0	≤ 50 mA
Interface		
Interface type		Serial interface (programming adapter required) 9600 BPS, no parity, 8 data bits, 1 stop bit
Input/Output		
Input/output type		1 synchronization connection, bidirectional
0 Level		0 ... 1 V
1 Level		4 V ... U_B
Input impedance		> 12 kΩ
Output rated operating current		< 12 mA
Pulse length		0.5 ... 300 ms (level 1)
Pulse interval		≥ 62.5 ms (level 0)
Synchronization frequency		
Common mode operation		≤ 16 Hz
Multiplex operation		≤ 17 Hz / n , n = number of sensors , n ≤ 10 (factory setting: n = 5)
Output		
Output type		2 switch outputs NPN, NO/NC, programmable
Rated operating current	I_e	200 mA , short-circuit/overload protected
Voltage drop	U_d	≤ 2 V
Repeat accuracy		≤ 0.1 % of full-scale value
Switching frequency	f	≤ 2.8 Hz
Range hysteresis	H	programmable , preset to 1 mm
Temperature influence		< 1.5 % of full-scale value
Compliance with standards and directives		
Standard conformity		
Standards		EN IEC 60947-5-2:2020 IEC 60947-5-2:2019
Approvals and certificates		
UL approval		cULus Listed, Class 2 Power Source
CCC approval		CCC approval / marking not required for products rated ≤36 V
Ambient conditions		
Ambient temperature		-40 ... 70 °C (-40 ... 158 °F)
Storage temperature		-40 ... 85 °C (-40 ... 185 °F)
Mechanical specifications		
Connection type		cable , 5-pin
Degree of protection		IP67
Material		
Housing		PA-GF35
Cable		PUR
Transducer		epoxy resin/hollow glass sphere mixture; polyurethane foam
Cable		
Sheath diameter		7.25 mm
Bending radius		> 37.3 mm , fixed > 74.7 mm , moving
Core cross section		5 x 0.82 mm ²
Length	L	2 m

Release date: 2022-11-23 Date of issue: 2022-11-23 Filename: 299135_eng.pdf

Refer to "General Notes Relating to Pepperl+Fuchs Product Information".

Pepperl+Fuchs Group
www.pepperl-fuchs.comUSA: +1 330 486 0001
fa-info@us.pepperl-fuchs.comGermany: +49 621 776 1111
fa-info@de.pepperl-fuchs.comSingapore: +65 6779 9091
fa-info@sg.pepperl-fuchs.com

PEPPERL+FUCHS

Technical Data

Mass	355 g
Factory settings	
Output 1	near switch point: 240 mm far switch point: 4000 mm Output mode: Window mode output behavior: NO contact
Output 2	near switch point: 500 mm far switch point: 2000 mm Output mode: Window mode output behavior: NO contact
Beam width	wide
Evaluation procedure	averaging (MxN) M = 5 N = 2
General information	
Supplementary information	Switch settings of the external programming adapter: "output load": pull-up "output logic": Inv

Connection

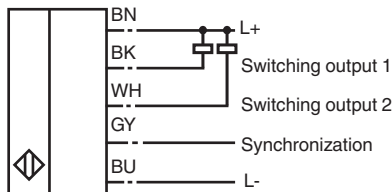

Wire colors in accordance with EN 60947-5-2

1	BN	(brown)
2	WH	(white)
3	BU	(blue)
4	BK	(black)
5	GY	(gray)

Characteristic Curve

Characteristic response curve

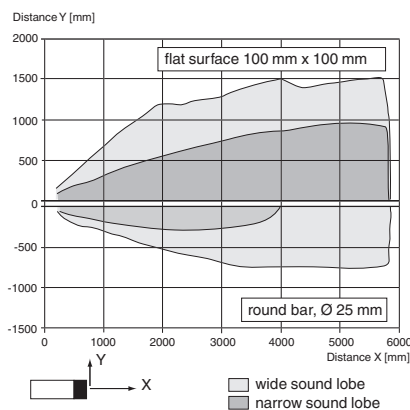

Release date: 2022-11-23 Date of issue: 2022-11-23 Filename: 299135_eng.pdf

Refer to "General Notes Relating to Pepperl+Fuchs Product Information".

Pepperl+Fuchs Group
www.pepperl-fuchs.com

USA: +1 330 486 0001
fa-info@us.pepperl-fuchs.com

Germany: +49 621 776 1111
fa-info@de.pepperl-fuchs.com

Singapore: +65 6779 9091
fa-info@sg.pepperl-fuchs.com

PF PEPPERL+FUCHS

Characteristic Curve

Switching output modes

1. Switch point mode

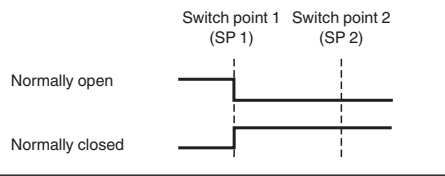

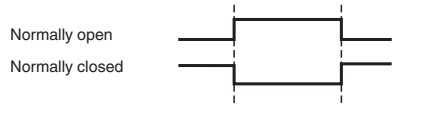

2. Window mode

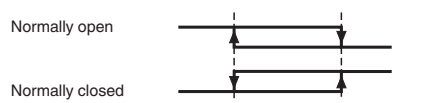

3. Hysteresis mode



Accessories

	<p>UC-PROG1-USB</p>	<p>Programming adapter</p>
	<p>V15S-G-0,3M-PUR-WAGO</p>	<p>Male cordset, M12, 5-pin, PUR cable with WAGO terminals</p>

Release date: 2022-11-23 Date of issue: 2022-11-23 Filename: 299135_eng.pdf

Refer to "General Notes Relating to Pepperl+Fuchs Product Information".

Pepperl+Fuchs Group
www.pepperl-fuchs.com

USA: +1 330 486 0001
fa-info@us.pepperl-fuchs.com

Germany: +49 621 776 1111
fa-info@de.pepperl-fuchs.com

Singapore: +65 6779 9091
fa-info@sg.pepperl-fuchs.com

Commissioning

Adjustment possibilities

The sensor is equipped with 2 switching outputs with 2 programmable switch points each. The programming of the switch points, the output mode, the output logic and the beam width can be done in two different ways:

- Using the sensor's programming buttons
- Using the sensor's serial interface. This method requires an external programming adapter and the corresponding software. You will find the download link for the software at www.pepperl-fuchs.com on the product page of the sensor.

Synchronization

The sensor features a synchronization input for suppressing ultrasonic mutual interference ("crosstalk"). The following synchronization modes are available:

1. Automatic multiplex mode
2. Automatic master slave common mode
3. Externally controlled synchronization

Further Documentation

For information on programming via programming buttons and synchronisation you may refer to the commissioning instruction.