

## Gegenmutter LN.M40.BN.K25

- Messing vernickelt
- Gewinde M40
- Verpackungseinheit: 25 Stück

### Abmessungen

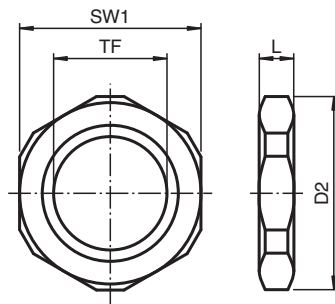

Abmessungen siehe Tabelle technische Daten.  
Abbildung und Zeichnung sind allgemeingültig für diesen Komponententyp und können von der spezifischen Variante abweichen.

Legende	
D2	Eckmaß
L	Gesamtlänge
SW1	Schlüsselweite
TF	Gewindegröße Innengewinde

### Technische Daten

Mechanische Daten	
Gewindetyp	Metrisch ISO, Steigung 1,5 mm
Innengewindegröße (TF)	M40
Material	Messing, vernickelt
Finish	Eigenfarbe silber
Abmessungen	
Eckmaß (D2)	51 mm

Veröffentlichungsdatum: 2020-06-02 Ausgabedatum: 2020-06-02 Dateiname: 312479\_ger.pdf

Beachten Sie „Allgemeine Hinweise zu Pepperl+Fuchs-Produktinformationen“.

Pepperl+Fuchs-Gruppe  
www.pepperl-fuchs.com

USA: +1 330 486 0002  
pa-info@us.pepperl-fuchs.com

Deutschland: +49 621 776 2222  
pa-info@de.pepperl-fuchs.com















Singapur: +65 6779 9091  
pa-info@sg.pepperl-fuchs.com

**PF** PEPPERL+FUCHS

## Technische Daten

Schlüsselweite (SW1)	46 mm
Gesamtlänge (L)	5 mm
<b>Allgemeine Informationen</b>	
Liefermenge	25
Lieferumfang	Gegenmuttern

## Passende Systemkomponenten

	<b>CG.AR.M40.SS.C.16.K10</b>
	<b>CG.AR.M40.BN.C.16.K05</b>
	<b>CG.CO.M40.BN.C.18.K05</b>
	<b>CG.EM.M40.BN.C.20.K05</b>
	<b>CG.EM.M40.SS.C.20.K05</b>
	<b>CG.NA.M40S.BN. C.18.K05</b>
	<b>CG.NA.M40S.SS. C.18.K05</b>
	<b>AD.M40.M32.BN. C.18.K20</b>
	<b>AD.M40.NPT1-1/2.BN. C.18.K20</b>
	<b>AD.M40.NPT1-1/2.SS. C.18.K20</b>
	<b>AD.M40.NPT1-1/4.BN. C.18.K20</b>
	<b>AD.M40.NPT1-1/4.SS. C.18.K20</b>
	<b>SP.MD.M40.BN.C.17.K10</b>
	<b>SP.MD.M40.SS.C.17.K10</b>
	<b>SP.PE.M40.PA.C.18.K10</b>

Veröffentlichungsdatum: 2020-06-02 Ausgabedatum: 2020-06-02 Dateiname: 312479\_ger.pdf

Beachten Sie „Allgemeine Hinweise zu Pepperl+Fuchs-Produktinformationen“.

Pepperl+Fuchs-Gruppe  
www.pepperl-fuchs.com

USA: +1 330 486 0002  
pa-info@us.pepperl-fuchs.com

Deutschland: +49 621 776 2222  
pa-info@de.pepperl-fuchs.com

Singapur: +65 6779 9091  
pa-info@sg.pepperl-fuchs.com

 **PEPPERL+FUCHS**