

Gegenmutter LN.M50.BN.K25

- Messing vernickelt
- Gewinde M50
- Verpackungseinheit: 25 Stück

Abmessungen

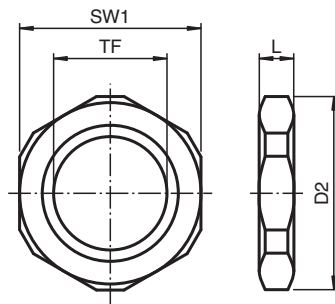

Abmessungen siehe Tabelle technische Daten.
Abbildung und Zeichnung sind allgemeingültig für diesen Komponententyp und können von der spezifischen Variante abweichen.

Legende

D2	Eckmaß
L	Gesamtlänge
SW1	Schlüsselweite
TF	Gewindegröße Innengewinde

Technische Daten

Mechanische Daten

Gewindetyp	Metrisch ISO, Steigung 1,5 mm
Innengewindegröße (TF)	M50
Material	Messing, vernickelt
Finish	Eigenfarbe silber
Abmessungen	
Eckmaß (D2)	66 mm

Veröffentlichungsdatum: 2020-06-02 Ausgabedatum: 2020-06-02 Dateiname: 312480_ger.pdf

Beachten Sie „Allgemeine Hinweise zu Pepperl+Fuchs-Produktinformationen“.

Pepperl+Fuchs-Gruppe
www.pepperl-fuchs.com

USA: +1 330 486 0002
pa-info@us.pepperl-fuchs.com

Deutschland: +49 621 776 2222
pa-info@de.pepperl-fuchs.com

















Singapur: +65 6779 9091
pa-info@sg.pepperl-fuchs.com

PF PEPPERL+FUCHS

Technische Daten

Schlüsselweite (SW1)	60 mm
Gesamtlänge (L)	5 mm
Allgemeine Informationen	
Liefermenge	25
Lieferumfang	Gegenmuttern

Passende Systemkomponenten

	CG.AR.M50.SS.C.16.K02
	CG.AR.M50.BN.C.16.K02
	CG.CO.M50.BN.C.18.K02
	CG.EM.M50.BN.C.20.K05
	CG.EM.M50.SS.C.20.K05
	CG.NA.M50.BN.C.18.K04
	CG.NA.M50S.BN.C.18.K05
	CG.NA.M50.SS.C.18.K04
	CG.NA.M50S.SS.C.18.K05
	AD.M50.M40.BN.C.18.K12
	AD.M50.NPT1-1/2.BN.C.18.K12
	AD.M50.NPT1-1/2.SS.C.18.K12
	AD.M50.NPT2.BN.C.18.K12
	AD.M50.NPT2.SS.C.18.K12
	SP.MD.M50.BN.C.17.K05
	SP.MD.M50.SS.C.17.K05
	SP.PE.M50.PA.C.18.K05

Veröffentlichungsdatum: 2020-06-02 Ausgabedatum: 2020-06-02 Dateiname: 312480_ger.pdf

Beachten Sie „Allgemeine Hinweise zu Pepperl+Fuchs-Produktinformationen“.

Pepperl+Fuchs-Gruppe
www.pepperl-fuchs.com

USA: +1 330 486 0002
pa-info@us.pepperl-fuchs.com

Deutschland: +49 621 776 2222
pa-info@de.pepperl-fuchs.com

Singapur: +65 6779 9091
pa-info@sg.pepperl-fuchs.com

 **PEPPERL+FUCHS**