

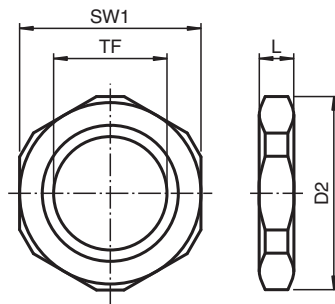

## Gegenmutter LN.M63.BN.K10

- Messing vernickelt
- Gewinde M63
- Verpackungseinheit: 10 Stück

### Abmessungen



Abmessungen siehe Tabelle technische Daten.  
Abbildung und Zeichnung sind allgemeingültig für diesen Komponententyp und können von der spezifischen Variante abweichen.

Legende	
D2	Eckmaß
L	Gesamtlänge
SW1	Schlüsselweite
TF	Gewindegröße Innengewinde

### Technische Daten

Mechanische Daten	
Gewindetyp	Metrisch ISO, Steigung 1,5 mm
Innengewindegröße (TF)	M63
Material	Messing, vernickelt
Finish	Eigenfarbe silber
Abmessungen	
Eckmaß (D2)	77 mm

Veröffentlichungsdatum: 2020-06-02 Ausgabedatum: 2020-06-02 Dateiname: 312481\_ger.pdf

Beachten Sie „Allgemeine Hinweise zu Pepperl+Fuchs-Produktinformationen“.

Pepperl+Fuchs-Gruppe  
www.pepperl-fuchs.com

USA: +1 330 486 0002  
pa-info@us.pepperl-fuchs.com

Deutschland: +49 621 776 2222  
pa-info@de.pepperl-fuchs.com













Singapur: +65 6779 9091  
pa-info@sg.pepperl-fuchs.com

**PF** PEPPERL+FUCHS

## Technische Daten

Schlüsselweite (SW1)	70 mm
Gesamtlänge (L)	6 mm
<b>Allgemeine Informationen</b>	
Liefermenge	10
Lieferumfang	Gegenmuttern

## Passende Systemkomponenten

	CG.AR.M63.SS.C.20.K02
	CG.AR.M63.BN.C.20.K02
	CG.CO.M63.BN.C.18.K02
	CG.NA.M63.BN.C.18.K02
	CG.NA.M63S.BN.C.18.K04
	CG.NA.M63.SS.C.18.K02
	CG.NA.M63S.SS.C.18.K04
	AD.M63.M50.BN.C.18.K12
	AD.M63.NPT2.BN.C.18.K12
	AD.M63.NPT2.SS.C.18.K12
	SP.MD.M63.BN.C.17.K05
	SP.MD.M63.SS.C.17.K05
	SP.PE.M63.PA.C.18.K05

Veröffentlichungsdatum: 2020-06-02 Ausgabedatum: 2020-06-02 Dateiname: 312481\_ger.pdf

Beachten Sie „Allgemeine Hinweise zu Pepperl+Fuchs-Produktinformationen“.

Pepperl+Fuchs-Gruppe  
www.pepperl-fuchs.com

USA: +1 330 486 0002  
pa-info@us.pepperl-fuchs.com

Deutschland: +49 621 776 2222  
pa-info@de.pepperl-fuchs.com

Singapur: +65 6779 9091  
pa-info@sg.pepperl-fuchs.com

 **PEPPERL+FUCHS**