

Connection cable

V15-W-E8-BK5M-PUR-A-V15-G



- Improved resistance to weld spatter
- Suitable for drag chains and abrasion resistant
- Suitable for robotic applications / torsion resistant
- Built-in LED, as operating and function indicator
- Degree of protection IP68 / IP69
- Free of paint wetting interfering substances
- Resistant to microbes and hydrolysis
- UL listed for USA and Canada
- Halogen-free
- Specific design protects against loosening and inaccurate installation

Cordset M12 socket angled A-coded LED 5-pin to M12 plug straight A-coded 5-pin, PUR cable weld spatter resistant black, UL approved, drag chain suitable, torsion resistant



Dimensions

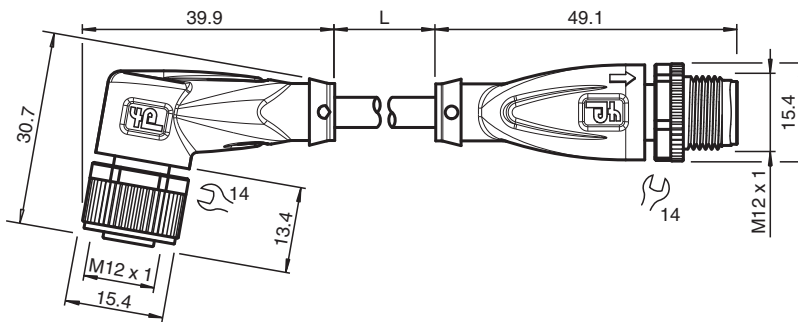

Technical Data

| General specifications | |
|-----------------------------------|--------------------------|
| Connector 1 | |
| Connection | socket |
| Construction type | M12 |
| Style | angled |
| Locking | screw connection |
| Number of pins | 5 |
| Coding | A-coded |
| Connector 2 | |
| Connection | plug |
| Construction type | M12 |
| Style | straight |
| Locking | screw connection |
| Number of pins | 5 |
| Coding | A-coded |
| Indicators/operating means | |
| LED green | Operating display |
| LED yellow | Functional display pin 4 |
| LED red | Functional display pin 2 |

Release date: 2023-07-05 Date of issue: 2023-07-05 Filename: 322567_eng.pdf

Refer to "General Notes Relating to Pepperl+Fuchs Product Information".

Pepperl+Fuchs Group
www.pepperl-fuchs.com

USA: +1 330 486 0001
fa-info@us.pepperl-fuchs.com

Germany: +49 621 776 1111
fa-info@de.pepperl-fuchs.com

Singapore: +65 6779 9091
fa-info@sg.pepperl-fuchs.com

PEPPERL+FUCHS

Technical Data

| Electrical specifications | | |
|----------------------------|----------------|---|
| Operating voltage | U _B | max. 24 V DC -20 % / +25 % |
| Operating current | I _B | max. 4 A |
| Conformity | | |
| Degree of protection | | EN 60529 |
| Plug connection | | connector M12 x 1 : IEC 61076-2-101 |
| Flammability | | UL 1581; DIN EN 60332-2-2 |
| Halogen-free | | DIN VDE 0472-815 IEC 60754-1 |
| Microbial resistance | | DIN EN 50525-2-21 / DIN VDE 0282-10 |
| Hydrolysis resistance | | DIN EN 50525-2-21 |
| Approvals and certificates | | |
| UL approval | | AWM STYLE 20549 AWM I/II A/B 80°C 300V FT2 (cable) |
| UL File Number | | E231213 |
| Ambient conditions | | |
| Ambient temperature | | |
| Plug connector | | -40 ... 90 °C (-40 ... 194 °F) |
| Cable, fixed | | -40 ... 80 °C (-40 ... 176 °F) |
| Cable, flexing | | -25 ... 80 °C (-13 ... 176 °F) |
| Pollution degree | | 3 |
| Mechanical specifications | | |
| Plug connector | | |
| Tightening torque | | 0.6 Nm |
| Loosening protection | | available |
| Tool installation | | straight knurling and hexagon nut SW = 14 mm |
| Mating cycles | | min. 100 |
| Degree of protection | | IP68 / IP69 |
| Cable | | according to IEC/EN 60228 (DIN VDE 0295) class 6 |
| Sheath diameter | | 4.7 mm |
| Bending radius | | > 10 x cable diameter, moving > 5 x cable diameter, fixed |
| Sheath stripping force | | max. 80 N / 300 mm |
| Sheath color | | black (similar to RAL 9005) |
| Number of cores | | 5 |
| Core cross section | | 0.34 mm ² |
| Cores color | | Core 1: brown Core 2: white Core 3: blue Core 4: black Core 5: grey |
| Core construction | | 42 x 0.1 mm Ø |
| Length | L | 5 m |
| Cable code | | Li F 9Y 11Y 5 x 0,34 |
| Drag chain suitability | | |
| Drag chain cycles | | min. 5000000 |
| Motion velocity | | max. 3.3 m/s |
| Traverse distance | | max. 5 m |
| Acceleration | | max. 5 m/s ² |
| Torsion cycles | | min. 1000000 |
| Torsional stress | | ± 180 °/m |
| Material | | |
| PWIS free | | yes |
| Halogen-free | | yes |
| Plug connector | | |
| Screw connection | | Zinc diecast, nickel-plated |

Release date: 2023-07-05 Date of issue: 2023-07-05 Filename: 322567_eng.pdf

Refer to "General Notes Relating to Pepperl+Fuchs Product Information".

Pepperl+Fuchs Group
www.pepperl-fuchs.comUSA: +1 330 486 0001
fa-info@us.pepperl-fuchs.comGermany: +49 621 776 1111
fa-info@de.pepperl-fuchs.comSingapore: +65 6779 9091
fa-info@sg.pepperl-fuchs.com

PEPPERL+FUCHS





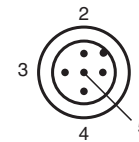
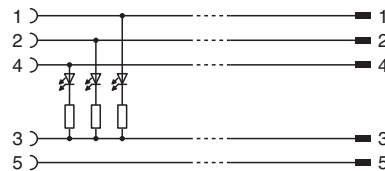
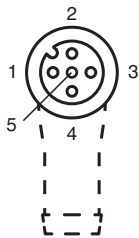

Technical Data

| | |
|------------------------------|------------------------|
| Body | TPU, transparent/black |
| Seal | FKM |
| Contact surface | gold plated (Au) |
| Flammability | V-2 |
| Cable | |
| Sheathing | PUR based on polyether |
| Core insulation | PP |
| Weld spatter resistance | yes |
| Chemical resistance | good |
| Oil resistance | yes |
| Cooling lubricant resistance | yes |
| Microbial resistance | yes |
| Hydrolysis resistance | yes |
| Flammability | FT2 |

Connection



Accessories

| | | |
|---|------------------------------|--|
|  | MH V1-SCREWDRIVER | Torque screwdriver (0.6 Nm) |
|  | MH V1-BIT M12 | plug-in cap M12 |
|  | V1/V3-LABELHOLDER | Label holder |
|  | V1/V3-LABEL | Label plate |
|  | MH V1-Holder | Modular universal holder for M12 connectors |
|  | V1-CLIP | Unlocking protector for M12 connector |
|  | V1-MARKING-RING-COLOR | Marking rings for M12 connectors, various colors |

Release date: 2023-07-05 Date of issue: 2023-07-05 Filename: 322567_eng.pdf