



Background suppression sensor

RL23-8-H-2000-IR/116/125



- Adjustable background suppression
- Infrared light
- Timer function
- Sturdy plastic housing
- Optical surface made of scratch-resistant glass

Background suppression sensor



Dimensions

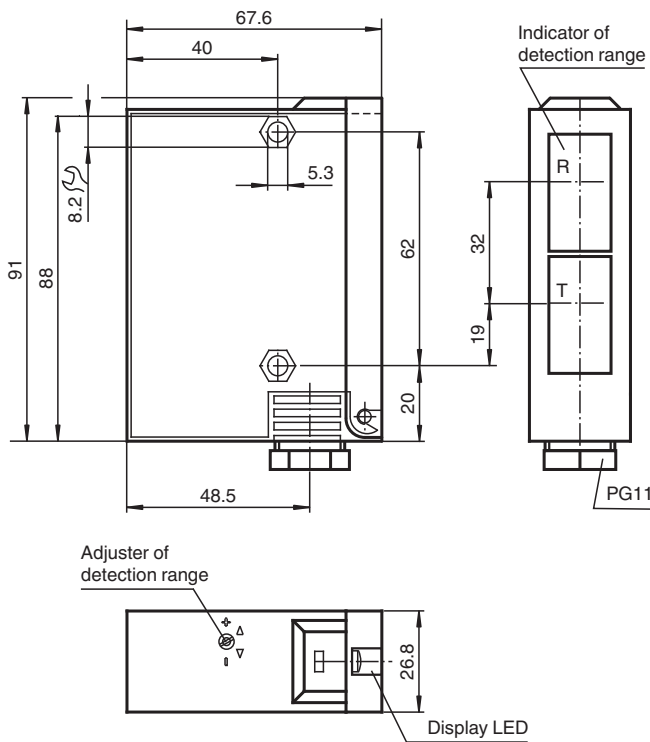

Terminal compartment
RL23-8-H-1000
RLK23-8-H-1000

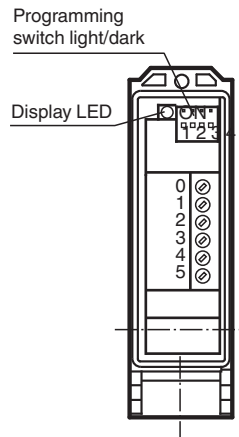

Terminal compartment
RL23-8-H-2000
RLK23-8-H-2000

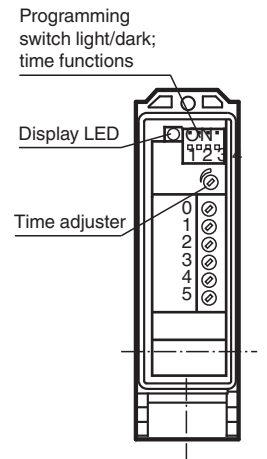

Release date: 2023-04-04 Date of issue: 2023-04-04 Filename: 4119434_eng.pdf

Refer to "General Notes Relating to Pepperl+Fuchs Product Information".

Pepperl+Fuchs Group
www.pepperl-fuchs.com

USA: +1 330 486 0001
fa-info@us.pepperl-fuchs.com

Germany: +49 621 776 1111
fa-info@de.pepperl-fuchs.com

Singapore: +65 6779 9091
fa-info@sg.pepperl-fuchs.com

PF PEPPERL+FUCHS

Technical Data

General specifications		
Detection range		50 ... 2000 mm
Detection range min.		50 ... 150 mm
Detection range max.		50 ... 3000 mm
Light source		IREd
Light type		modulated infrared light
Black-white difference (6 %/90 %)		< 20 %
Diameter of the light spot		50 mm at 2000 mm sensor range
Opening angle		1.5 °
Ambient light limit		5000 Lux
Functional safety related parameters		
MTTF _d		540 a
Mission Time (T _M)		20 a
Diagnostic Coverage (DC)		60 %
Indicators/operating means		
Function indicator		LED yellow, lights up with receiver lit
Control elements		Programming switch for light/dark switching
Control elements		Sensing range adjuster
Control elements		Time adjuster
Electrical specifications		
Operating voltage	U _B	10 ... 30 V DC
Ripple		10 %
No-load supply current	I ₀	100 mA
Input		
Test input		emitter deactivation at +U _B
Output		
Switching type		light/dark on
Signal output		2 PNP, complementary, 1 NPN short-circuit protected, reverse polarity protected
Switching voltage		30 V DC
Switching current		max. 200 mA
Switching frequency	f	70 Hz
Response time		5 ms
Timer function		ON delay (GAN), OFF delay (GAB), one shot (IAB), programmable, adjustment range 0.1 ... 10 s
Conformity		
Product standard		EN 60947-5-2
Approvals and certificates		
UL approval		cULus
CCC approval		CCC approval / marking not required for products rated ≤36 V
Ambient conditions		
Ambient temperature		-20 ... 60 °C (-4 ... 140 °F)
Storage temperature		-20 ... 75 °C (-4 ... 167 °F)
Mechanical specifications		
Housing width		26.8 mm
Housing height		91 mm
Housing depth		67.6 mm
Degree of protection		IP65
Connection		terminal compartment
Material		
Housing		Terluran® GV15
Optical face		glass
Mass		180 g

Release date: 2023-04-04 Date of issue: 2023-04-04 Filename: 419434_eng.pdf

Refer to "General Notes Relating to Pepperl+Fuchs Product Information".

Pepperl+Fuchs Group
www.pepperl-fuchs.comUSA: +1 330 486 0001
fa-info@us.pepperl-fuchs.comGermany: +49 621 776 1111
fa-info@de.pepperl-fuchs.comSingapore: +65 6779 9091
fa-info@sg.pepperl-fuchs.com

PEPPERL+FUCHS

Connection Assignment

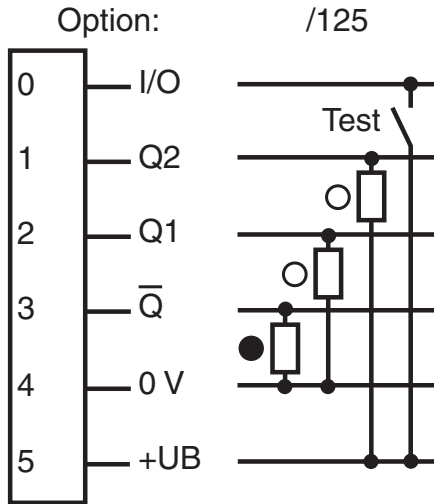



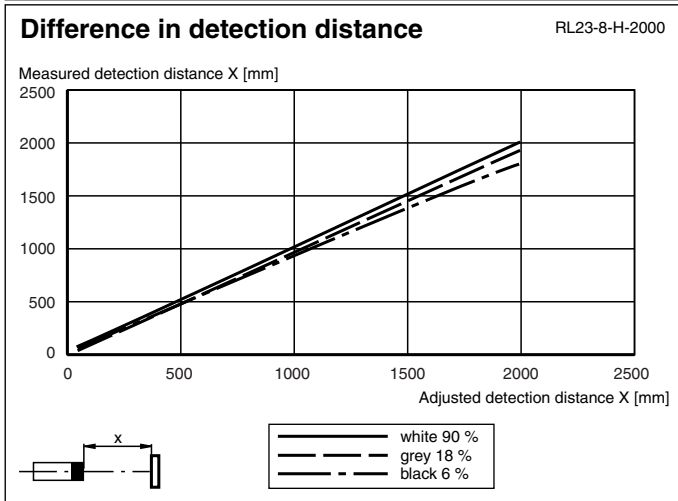
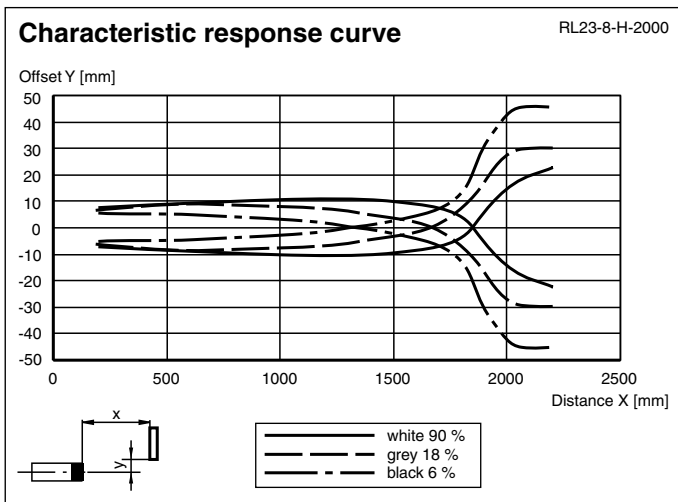

○ = Light on
● = Dark on

Characteristic Curve



Release date: 2023-04-04 Date of issue: 2023-04-04 Filename: 419434_eng.pdf

Accessories

	OMH-05	Mounting aid for round steel ø 12 mm or sheet 1.5 mm ... 3 mm
	OMH-21	Mounting bracket: mounting aid for sensors in the RL* series
	OMH-22	Mounting aid for RL* series
	OMH-RLK29-HW	Mounting bracket for rear wall mounting

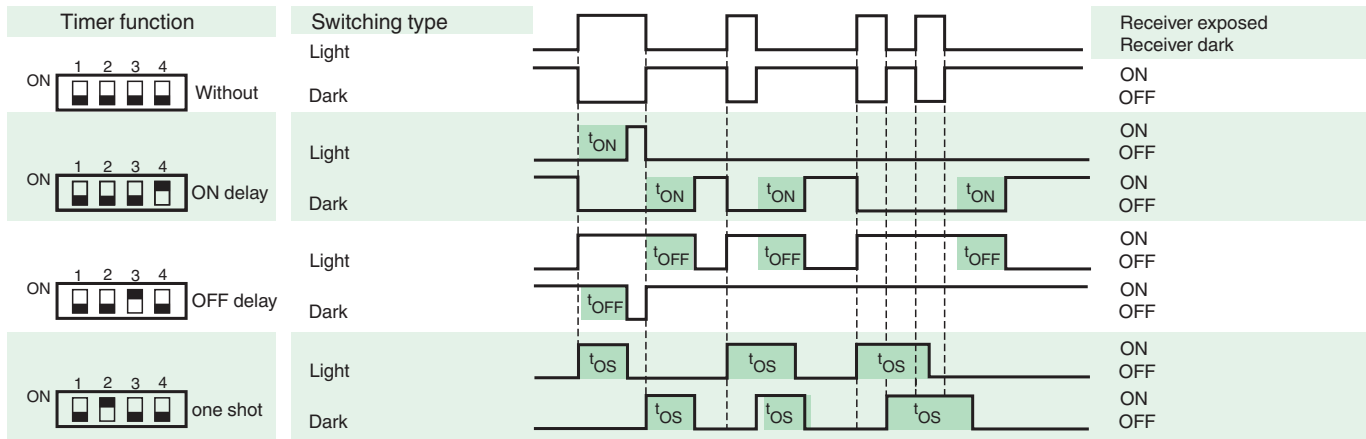

Timer functions



Time t_{ON} , t_{OFF} and t_{OS} are adjustable from 0.1 to 10 seconds.
 The Light-/Dark-Switch (Left, outer switch) is shown in the "Dark ON" position.

Type	Description	Notes
-Z	OFF delay timer	Adjustable time interval (0.1 s - 10 s)
	one shot timer	
	ON delay timer	

Light-on/dark-on changeover switch

	Dark on
	Light on

Release date: 2023-04-04 Date of issue: 2023-04-04 Filename: 419434_eng.pdf