



Background suppression sensor

RL28-8-H-2000-IR/49/105



- Ultra bright LEDs for power on and switching state
- Minimal black-white difference through the infrared transmission LED
- Not sensitive to ambient light, even with energy saving lamps
- Waterproof, degree of protection IP67
- Protection class II

Background suppression sensor



Dimensions

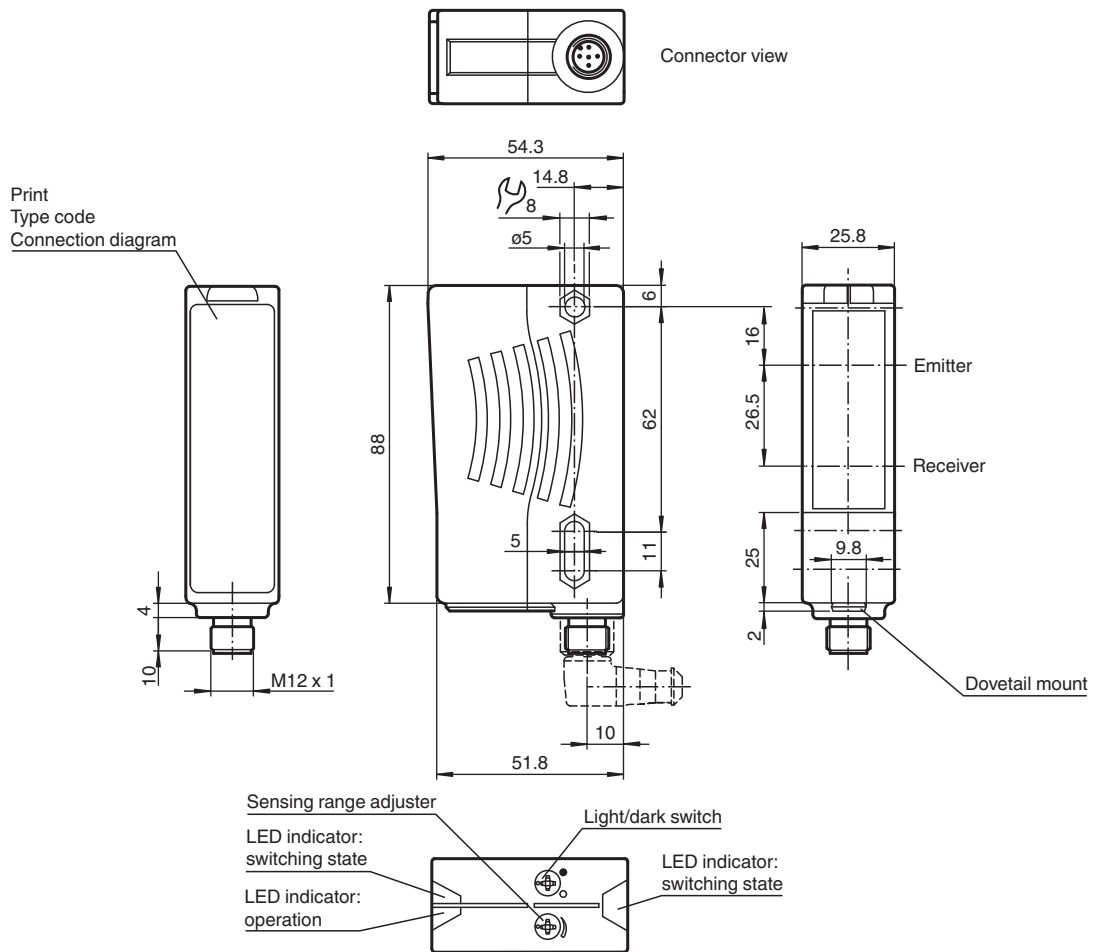

Release date: 2023-04-04 Date of issue: 2023-04-04 Filename: 419612_eng.pdf

Refer to "General Notes Relating to Pepperl+Fuchs Product Information".

Pepperl+Fuchs Group
www.pepperl-fuchs.com

USA: +1 330 486 0001
fa-info@us.pepperl-fuchs.com

Germany: +49 621 776 1111
fa-info@de.pepperl-fuchs.com

Singapore: +65 6779 9091
fa-info@sg.pepperl-fuchs.com

PF PEPPERL+FUCHS

Technical Data

General specifications		
Detection range		20 ... 2000 mm
Detection range min.		20 ... 200 mm
Detection range max.		20 ... 2000 mm
Background suppression		max. + 10 % of the upper limit of the detection range
Light source		IRED
Light type		modulated infrared light , 880 nm
Black-white difference (6 %/90 %)		< 40 %
Diameter of the light spot		approx. 70 mm at a distance of 2000 mm
Opening angle		transmitter 2° receiver 2°
Ambient light limit		50000 Lux
Functional safety related parameters		
MTTF _d		720 a
Mission Time (T _M)		20 a
Diagnostic Coverage (DC)		0 %
Indicators/operating means		
Operation indicator		LED green
Function indicator		2 LEDs yellow ON: object inside the scanning range OFF: object outside the scanning range
Control elements		Sensing range adjuster , Light-on/dark-on changeover switch
Electrical specifications		
Operating voltage	U _B	10 ... 30 V DC
Ripple		10 %
No-load supply current	I ₀	≤ 40 mA
Output		
Switching type		light/dark on switchable
Signal output		1 NPN, 1 PNP synchronized-switching, short-circuit protected, reverse polarity protected , open collectors
Switching voltage		max. 30 V DC
Switching current		max. 200 mA
Switching frequency	f	250 Hz
Response time		2 ms
Conformity		
Product standard		EN 60947-5-2
Approvals and certificates		
Protection class		II, rated voltage ≤ 250 V AC with pollution degree 1-2 according to IEC 60664-1
UL approval		E87056 , cULus Listed , class 2 power supply , type rating 1
Ambient conditions		
Ambient temperature		-40 ... 60 °C (-40 ... 140 °F)
Storage temperature		-40 ... 60 °C (-40 ... 140 °F)
Mechanical specifications		
Housing width		25.8 mm
Housing height		88 mm
Housing depth		54.3 mm
Degree of protection		IP67
Connection		5-pin, M12 x 1 connector
Material		
Housing		Plastic ABS
Optical face		plastic
Connector		plastic
Mass		70 g

Connection

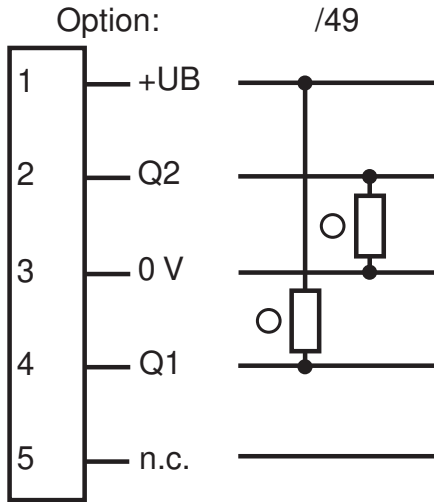

○ = Light on
● = Dark on

Connection Assignment

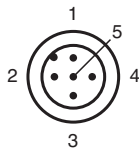

Wire colors in accordance with EN 60947-5-2

1	BN	(brown)
2	WH	(white)
3	BU	(blue)
4	BK	(black)
5	GY	(gray)

Characteristic Curve

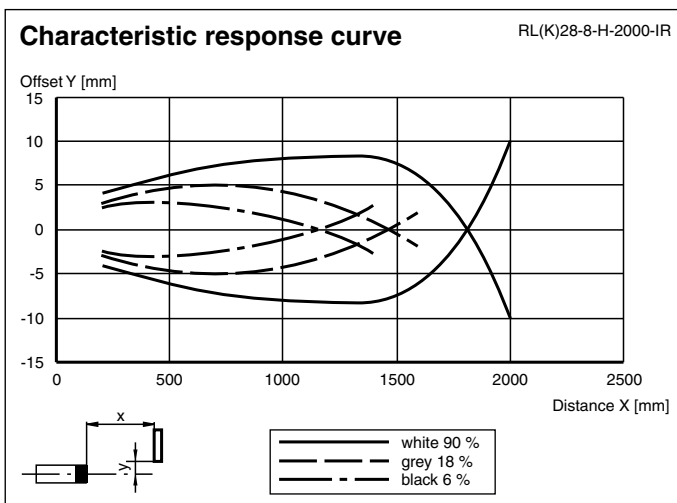

Release date: 2023-04-04 Date of issue: 2023-04-04 Filename: 419612_eng.pdf

Refer to "General Notes Relating to Pepperl+Fuchs Product Information".

Pepperl+Fuchs Group
www.pepperl-fuchs.com

USA: +1 330 486 0001
fa-info@us.pepperl-fuchs.com

Germany: +49 621 776 1111
fa-info@de.pepperl-fuchs.com

Singapore: +65 6779 9091
fa-info@sg.pepperl-fuchs.com



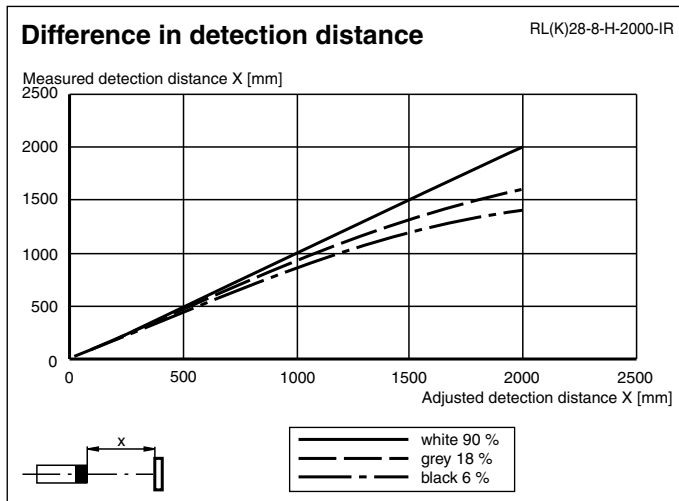

Characteristic Curve



Application



Accessories

	OMH-05	Mounting aid for round steel \varnothing 12 mm or sheet 1.5 mm ... 3 mm
	OMH-21	Mounting bracket: mounting aid for sensors in the RL* series
	OMH-22	Mounting aid for RL* series
	OMH-RLK29-HW	Mounting bracket for rear wall mounting
	OMH-RL28-C	Weld slag cover model

Additional information**Intended use:**

The transmitter and receiver are located in the same housing for direct detection sensors with background masking. Marking of objects outside the detection range is achieved by arranging the angle between the transmitter and receiver (2 receiver elements).

Objects are detected independently of their surface structures, brightness and colour, as well as the brightness of the background.

Mounting instructions:

The sensors can be fastened directly with fixing screws or with a support bracket (not included with delivery).

The surface underneath must be flat to prevent the housing from moving when it is tightened into position. We recommend securing the nut and screw in place with spring washers to prevent the sensor from going out of adjustment.

Adjustment:

After the operating voltage is applied, the LED is lit green.

Align the sensor to the background. If the yellow LED is lit, the detection range should be reduced with the detection range adjuster until the yellow LED goes out.

Object direction:

Place the object to be detected at the desired maximum detection range and align the light spot to it. If the object is detected, the yellow LED lights up.

If it does not light up, the detection range must be adjusted on the potentiometer until it lights up when an object is detected.

Cleaning:

We recommend cleaning the optical surface and checking the screwed connection and other connections at regular intervals.