



Model Number

VMA-2+P-2M-PUR-V1-G

Valve connector, Form A, 2+PE, PUR cable, M12 plug

Features

- Valve connector according EN 175301-803 A/ISO 4400 (previously DIN 43650)
- Moulded seal
- Suitable for drag chains
- freely selectable cable models due to bridged protective earth
- Flame resistant cable
- Halogen-free

Dimensions

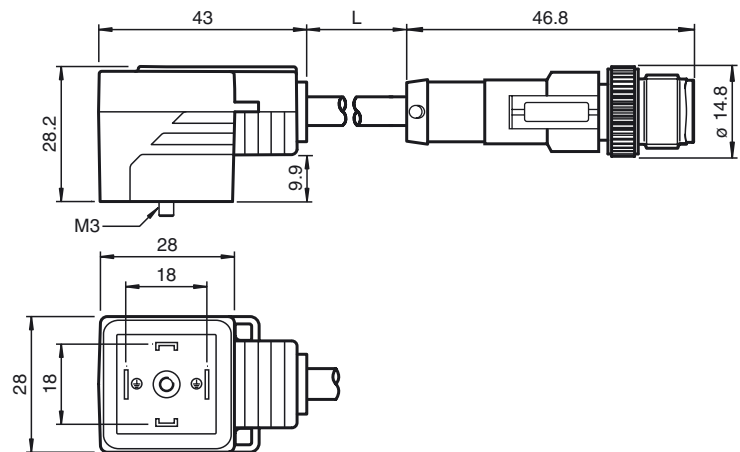

Technical data

General specifications

Number of pins 2 + PE

Electrical specifications

Operating voltage U_B 250 V AC/DC
 Operating current I_B max. 4 A
 Volume resistance < 10 m Ω

Ambient conditions

Ambient temperature Body: -25 ... 80 °C (-13 ... 176 °F)
 cable, flexing: -20 ... 80 °C (-4 ... 176 °F)
 cable, fixed: -40 ... 80 °C (-40 ... 176 °F)

Pollution degree 3

Mechanical specifications

Degree of protection IP65/IP67

Connection Valve connector Form A

Material

Contacts CuSn

Contact surface Sn

Body Valve Connector Cordset TPU, black
 Body TPU, black

Cable PUR

Core insulation PP

Cable

Sheath diameter \varnothing 4.5 mm

Bending radius > 50 mm
 > 22.5 mm, fixed

Color dark grey (RAL 7021)

Cores (2 + 1) x 0.5 mm²; 20 AWG

Conductor construction 28 x 0.15 mm \varnothing

Length L 2 m

Drag chain suitability

Drag chain cycles \geq 15000000

Motion velocity \leq 5 m/s

Traverse distance 0.9 m

Acceleration \leq 30 m/s²

Electrical connection

