



### Model Number

#### VMBI-2+P/Z2-1M-PUR-V1-G

Valve connector, Form B (Ind), 2+PE, Z-diode, PUR cable to M12 round plug connector

### Features

- Valve connector according EN 175301-803 A/ISO 4400 (previously DIN 43650)
- Z diode as a protective circuit
- Built-in LED, as operating and function indicator
- Moulded seal
- Flame resistant cable
- Halogen-free

### Dimensions

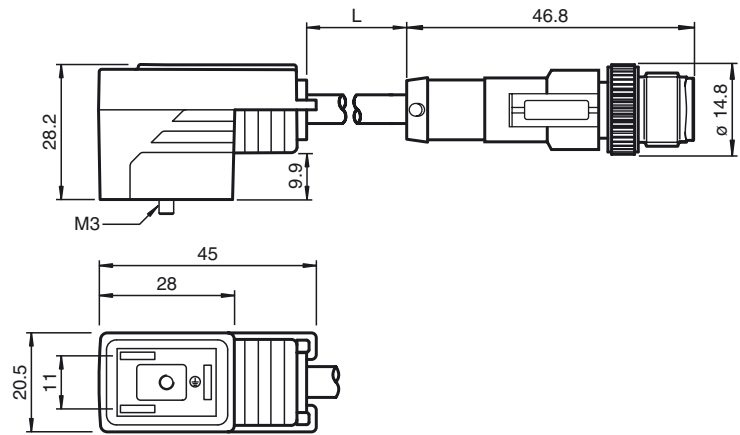

### Technical data

#### General specifications

Number of pins 2 + PE

#### Indicators/operating means

LED yellow Functional display

#### Electrical specifications

Operating voltage  $U_B$  24 V AC/DC

Operating current  $I_B$  max. 4 A

Volume resistance < 5 m $\Omega$

Suppression Zener diode

#### Ambient conditions

Ambient temperature Body: -20 ... 85 °C (-4 ... 185 °F)  
cable, flexing: -20 ... 80 °C (-4 ... 176 °F)  
cable, fixed: -40 ... 80 °C (-40 ... 176 °F)

Pollution Degree 3

#### Mechanical specifications

Degree of protection IP65/IP67

Connection Valve connector Form B (Ind)

#### Material

Contacts CuSn

Contact surface Sn

Body TPU, black

Cable PUR

Core insulation PP

#### Cable

Sheath diameter  $\varnothing$  4.5 mm

Bending radius > 50 mm

> 22.5 mm, fixed

Color black

Cores (2 + 1) x 0.5 mm<sup>2</sup>; 20 AWG

Conductor construction 28 x 0.15 mm  $\varnothing$

Length L 1 m

### Electrical connection

