

Connection cable, Ethernet V1SD-W-70M-PUR-ABG-V45-G

- Hard-wearing PUR cable
- Industrial Ethernet
- D coding for Ethernet
- CAT5/CAT5e cable
- Free of paint wetting interfering substances
- Halogen-free
- Screw connection suitable for tool assembly
- Immunity to vibration, with mechanical latching

Ethernet bus cable M12 plug angled D-coded to RJ45 Ethernet-coded, 4-pin, PUR cable blue, Cat5e, shielded



Dimensions

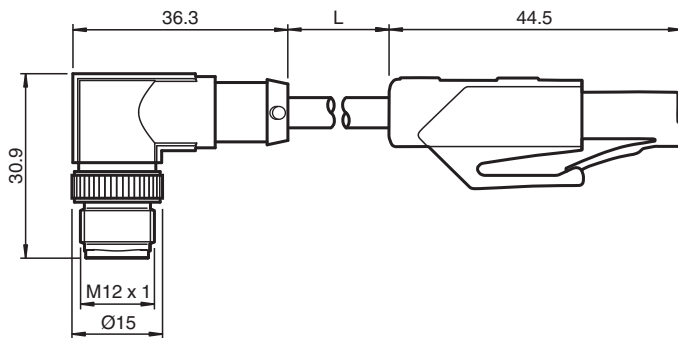

Technical Data

General specifications

Connector 1	
Connection	plug
Construction type	M12
Style	angled
Locking	screw connection
Number of pins	4
Coding	D-coded
Connector 2	
Connection	plug
Construction type	RJ45
Style	straight
Locking	snap locking
Number of pins	8

Electrical specifications

Operating voltage	U_B	max. 48 V AC / 60 V DC
Operating current	I_B	max. 1 A

Conformity

Degree of protection	EN 60529
----------------------	----------

Release date: 2023-07-12 Date of issue: 2023-07-13 Filename: 70101608_eng.pdf

Refer to "General Notes Relating to Pepperl+Fuchs Product Information".

Pepperl+Fuchs Group
www.pepperl-fuchs.com

USA: +1 330 486 0001
fa-info@us.pepperl-fuchs.com

Germany: +49 621 776 1111
fa-info@de.pepperl-fuchs.com

Singapore: +65 6779 9091
fa-info@sg.pepperl-fuchs.com

PEPPERL+FUCHS

Technical Data

Plug connection		connector M12 x 1 : IEC 61076-2-101 connector RJ45 : IEC 60603-7
Component category		CAT5 (IEC 11801) , CAT5e (IEC 61156-6)
Flammability		IEC 60332-1-2 / UL 2556
Halogen-free		IEC 60754-1
Ambient conditions		
Ambient temperature		
Connector 1		-25 ... 90 °C (-13 ... 194 °F)
Connector 2		-25 ... 60 °C (-13 ... 140 °F)
Cable, fixed		-40 ... 80 °C (-40 ... 176 °F)
Cable, flexing		-20 ... 80 °C (-4 ... 176 °F)
Mechanical specifications		
Connector 1		
Tightening torque		0.4 Nm
Loosening protection		available
Tool installation		straight knurling
Mating cycles		min. 100
Shielding		shield connected to screw connection
Degree of protection		IP65/IP67
Connector 2		
Loosening protection		available
Mating cycles		min. 750
Shielding		shield connected to connector
Degree of protection		IP20
Cable		
		according to IEC/EN 60228 (DIN VDE 0295) class 5
Sheath diameter		6.4 mm
Bending radius		> 8 x cable diameter, moving > 4 x cable diameter, fixed
Sheath color		water blue (RAL 5021)
Number of cores		4
Core cross section		0.14 mm ²
Cores color		Core 1-1: white/orange Core 2-3: white/green Core 3-2: orange Core 4-6: green
Core construction		7 x 0.16 mm Ø twisted pairs
Shield		aluminum-lined polyester foil Tinned copper braiding, 70 % coverage
Length	L	70 m
Material		
PWIS free		yes
Halogen-free		yes
Connector 1		
Screw connection		Zinc diecast, nickel-plated
Body		TPU, black
Contact surface		Ni/Au
Flammability		V-2
Connector 2		
Body		PA, grey
Contact surface		Ni/Au
Flammability		V-0
Cable		
Sheathing		PUR
Core insulation		PE
Flammability		VW-1

Release date: 2023-07-12 Date of issue: 2023-07-13 Filename: 70101608_eng.pdf

Refer to "General Notes Relating to Pepperl+Fuchs Product Information".





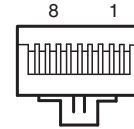
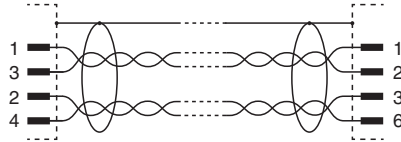
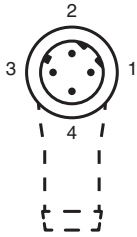

Pepperl+Fuchs Group
www.pepperl-fuchs.comUSA: +1 330 486 0001
fa-info@us.pepperl-fuchs.comGermany: +49 621 776 1111
fa-info@de.pepperl-fuchs.comSingapore: +65 6779 9091
fa-info@sg.pepperl-fuchs.com

PEPPERL+FUCHS

Connection



Accessories

	MH V1-SCREWDRIVER	Torque screwdriver (0.6 Nm)
	MH V1-BIT M12	plug-in cap M12
	V1/V3-LABELHOLDER	Label holder
	V1/V3-LABEL	Label plate
	MH V1-Holder	Modular universal holder for M12 connectors
	V1-CLIP	Unlocking protector for M12 connector
	V1-MARKING-RING-COLOR	Marking rings for M12 connectors, various colors

Release date: 2023-07-12 Date of issue: 2023-07-13 Filename: 70101608_eng.pdf