

Switch Amplifier

KCD2-SR-Ex2.SP

- 2-channel isolated barrier
- 24 V DC supply (Power Rail)
- Dry contact or NAMUR inputs
- Relay contact output
- Line fault detection (LFD)
- Housing width 12.5 mm
- Connection via spring terminals with push-in connection technology
- Up to SIL 2 (SC 3) acc. to IEC/EN 61508



Function

This isolated barrier is used for intrinsic safety applications. The device transfers digital signals from NAMUR sensors or dry contacts from the hazardous area to the non-hazardous area. The proximity sensor or the mechanical contact controls the control side load for a relay contact output. The device output changes the state when the input signal changes the state. Via switches the mode of operation can be reversed and the line fault detection can be switched off. During a fault condition, the relay reverts to its de-energized state and the LEDs indicate the fault according to NAMUR NE 44. If the device is operated via Power Rail, additionally a collective error message is available. Due to its compact housing design and low heat dissipation, this device is useful for detecting positions, end stops, and switching states in space-critical applications.

Connection

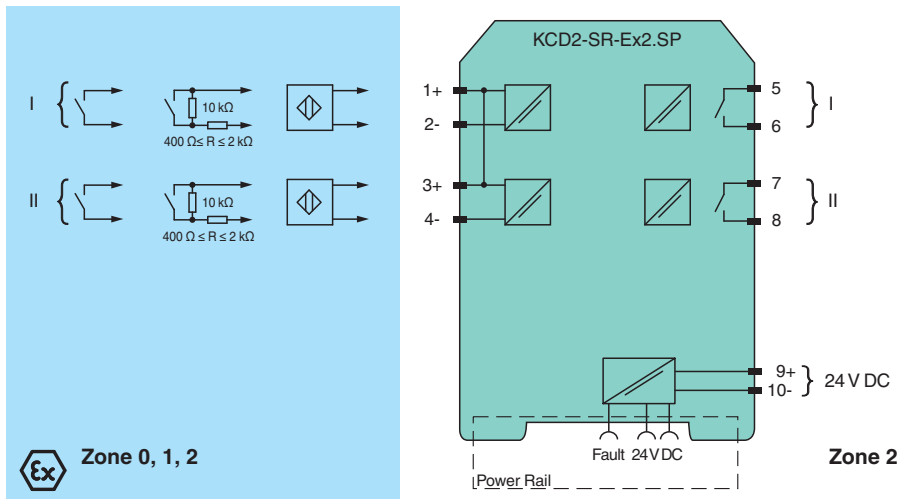

Technical Data

General specifications	
Signal type	Digital Input
Functional safety related parameters	
Safety Integrity Level (SIL)	SIL 2
Systematic capability (SC)	SC 3
Supply	
Connection	Power Rail or terminals 9+, 10-
Rated voltage	U_r 19 ... 30 V DC
Ripple	≤ 10 %

Release date: 2023-01-03 Date of issue: 2023-01-03 Filename: 70112160_eng.pdf

Refer to "General Notes Relating to Pepperl+Fuchs Product Information".

Pepperl+Fuchs Group
www.pepperl-fuchs.com

USA: +1 330 486 0002
pa-info@us.pepperl-fuchs.com

Germany: +49 621 776 2222
pa-info@de.pepperl-fuchs.com

Singapore: +65 6779 9091
pa-info@sg.pepperl-fuchs.com

PF PEPPERL+FUCHS

Technical Data

Rated current	I_r	≤ 46 mA
Power dissipation		≤ 900 mW
Power consumption		≤ 900 mW
Input		
Connection side		field side
Connection		terminals 1+, 2-, 3+, 4-
Rated values		acc. to EN 60947-5-6 (NAMUR)
Open circuit voltage/short-circuit current		approx. 8 V DC / approx. 8 mA
Switching point/switching hysteresis		1.2 ... 2.1 mA / approx. 0.2 mA
Line fault detection		breakage $I \leq 0.1$ mA , short-circuit $I \geq 6.5$ mA
Pulse/Pause ratio		min. 20 ms / min. 20 ms
Output		
Safety note		If load voltage > 50 V, de-energize before removing the terminals.
Connection side		control side
Connection		terminals 5, 6; 7, 8
Output I		signal ; relay
Output II		signal ; relay
Contact loading		250 V AC/2 A/cos $\phi > 0.75$; 126.5 V AC/4 A/cos $\phi > 0.75$; 30 V DC/2 A resistive load
Minimum switch current		2 mA / 24 V DC
Energized/De-energized delay		≤ 20 ms / ≤ 20 ms
Mechanical life		10^7 switching cycles
Transfer characteristics		
Switching frequency		≤ 10 Hz
Galvanic isolation		
Input/Output		reinforced insulation according to IEC/EN 61010-1, rated insulation voltage 300 V _{eff}
Input/power supply		reinforced insulation according to IEC/EN 61010-1, rated insulation voltage 300 V _{eff}
Output/power supply		reinforced insulation according to IEC/EN 61010-1, rated insulation voltage 300 V _{eff}
Output/Output		reinforced insulation according to IEC/EN 61010-1, rated insulation voltage 300 V _{eff}
Indicators/settings		
Display elements		LEDs
Control elements		DIP switch
Configuration		via DIP switches
Labeling		space for labeling at the front
Directive conformity		
Electromagnetic compatibility		
Directive 2014/30/EU		EN 61326-1:2013 (industrial locations)
Low voltage		
Directive 2014/35/EU		EN 61010-1:2010+A1:2019+A1:2019/AC:2019
Conformity		
Electromagnetic compatibility		NE 21:2017 , EN 61326-3-1:2017 , EN IEC 61326-3-2:2018
Degree of protection		IEC 60529:1989+A1:1999+A2:2013
Functional safety		IEC/EN 61508:2010
Input		EN 60947-5-6:2000
Ambient conditions		
Ambient temperature		-40 ... 70 °C (-40 ... 158 °F)
Mechanical specifications		
Degree of protection		IP20
Connection		spring terminals
Mass		approx. 100 g
Dimensions		12.5 x 119 x 114 mm (0.5 x 4.7 x 4.5 inch) (W x H x D) , housing type A2
Mounting		on 35 mm DIN mounting rail acc. to EN 60715:2001
Data for application in connection with hazardous areas		
EU-type examination certificate		BASEEFA 06 ATEX 0092 X

Release date: 2023-01-03 Date of issue: 2023-01-03 Filename: 70112160_eng.pdf

Technical Data

Marking		Ⓜ II 3(1)G Ex ec nC [ia Ga] IIC T4 Gc , Ⓜ II (1)D [Ex ia Da] IIIC , Ⓜ I (M1) [Ex ia Ma] I
Input		Ex ia
Voltage	U _o	10.5 V
Current	I _o	13 mA
Power	P _o	34 mW (linear characteristic)
Supply		
Maximum safe voltage	U _m	253 V AC (Attention! U _m is no rated voltage.)
Output		
Contact loading		Zone 2 : 50 V AC/2 A/cos φ > 0.75; 30 V DC/2 A resistive load
Maximum safe voltage	U _m	253 V AC (Attention! The rated voltage can be lower.)
Fault indication output		
Maximum safe voltage	U _m	40 V DC (Attention! U _m is no rated voltage.)
Galvanic isolation		
Input/Output		safe electrical isolation acc. to IEC/EN 60079-11, voltage peak value 375 V
Input/power supply		safe electrical isolation acc. to IEC/EN 60079-11, voltage peak value 375 V
Directive conformity		
Directive 2014/34/EU		EN IEC 60079-0:2018 , EN 60079-7:2015+A1:2018 , EN 60079-11:2012 , EN IEC 60079-15:2019
International approvals		
UL approval		E106378
Control drawing		116-0477 (cULus)
IECEx approval		
IECEx certificate		IECEx BAS 06.0025 X
IECEx marking		Ex ec nC [ia Ga] IIC T4 Gc [Ex ia Da] IIIC [Ex ia Ma] I
General information		
Supplementary information		Observe the certificates, declarations of conformity, instruction manuals, and manuals where applicable. For information see www.pepperl-fuchs.com .

Assembly



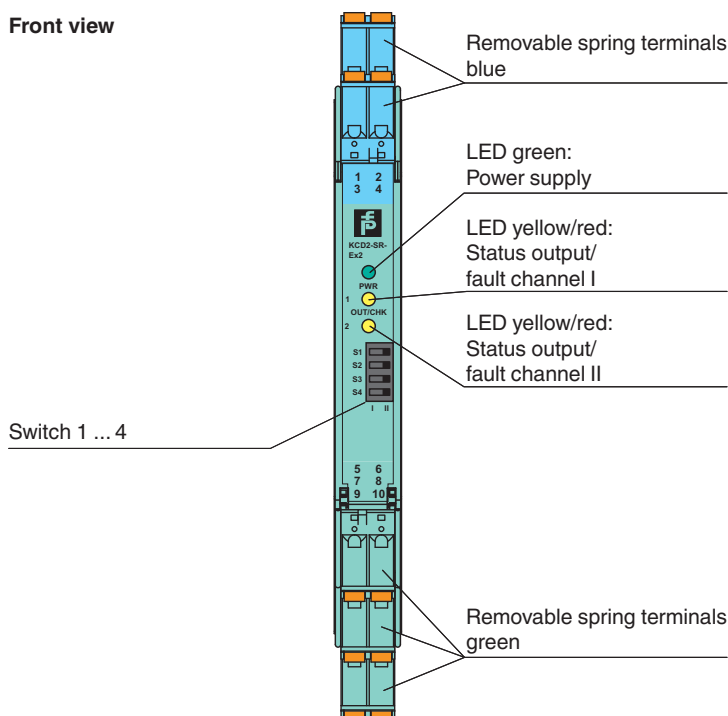



Front view







Release date: 2023-01-03 Date of issue: 2023-01-03 Filename: 70112160_eng.pdf

Refer to "General Notes Relating to Pepperl+Fuchs Product Information".

Matching System Components

	KFD2-EB2	Power Feed Module
	UPR-03	Universal Power Rail with end caps and cover, 3 conductors, length: 2 m
	UPR-03-M	Universal Power Rail with end caps and cover, 3 conductors, length: 1,6 m
	UPR-03-S	Universal Power Rail with end caps and cover, 3 conductors, length: 0.8 m
	K-DUCT-BU	Profile rail, wiring comb field side, blue
	K-DUCT-BU-UPR-03	Profile rail with UPR-03- * insert, 3 conductors, wiring comb field side, blue

Accessories

	F-NR3-Ex1	NAMUR Resistor Network
	KC-CTT-3GN2BU	Terminal block for KC modules, 2-pin spring terminal, with test sockets
	KC-CTT-5BU	Terminal block for KC modules, 2-pin spring terminal, with test sockets, blue
	KC-CTT-5GN	Terminal block for KC modules, 2-pin spring terminal, with test sockets, green
	KF-CP	Red coding pins, packaging unit: 20 x 6

Configuration

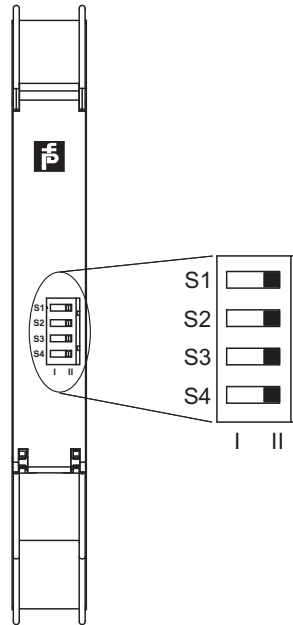

Switch position

S	Function		Position
1	Mode of operation Output I (relay) energized	with high input current	I
		with low input current	II
2	Mode of operation Output II (relay) energized	with high input current	I
		with low input current	II
3	Line fault detection Input I	ON	I
		OFF	II
4	Line fault detection Input II	ON	I
		OFF	II

Operating status

Control circuit	Input signal
Initiator high impedance/contact opened	low input current
Initiator low impedance/contact closed	high input current
Lead breakage, lead short-circuit	Line fault

Factory settings: switch 1, 2, 3 and 4 in position I

Characteristic Curve

Maximum switching power of output contacts

Release date: 2023-01-03 Date of issue: 2023-01-03 Filename: 70112160_eng.pdf

Refer to "General Notes Relating to Pepperl+Fuchs Product Information".

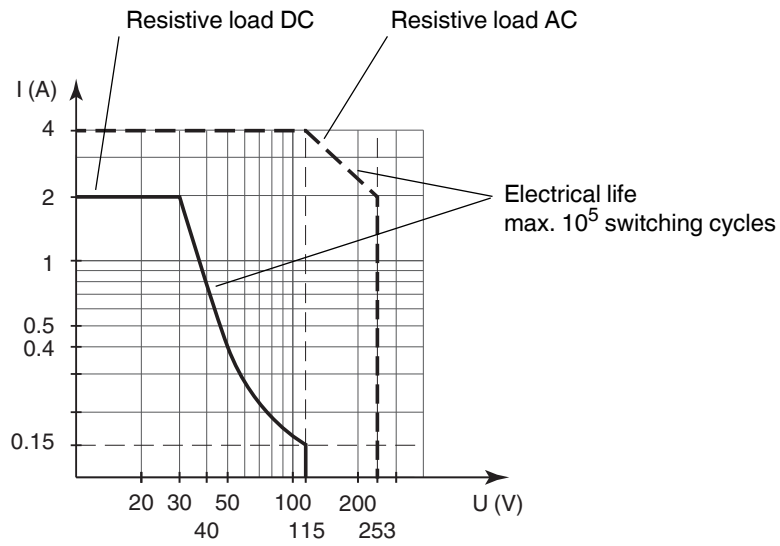

The maximum number of switching cycles is depending on the electrical load and may be higher when reduced currents and voltages are applied.

Release date: 2023-01-03 Date of issue: 2023-01-03 Filename: 70112160_eng.pdf