



Retroreflective sensor

OBR5000-18GM40A-E2



- Strong metallic housing in cylindrical shape M18 x 1
- Not sensitive to ambient light
- Degree of protection IP67
- Very high detection range

Retroreflective sensor



Function

The optical sensors of this series have an M18 threaded housing that is optionally available in plastic or metal. The sensors are robust and versatile. Focusing on the essential requirements simplifies selection and commissioning, saving time and costs.

Dimensions

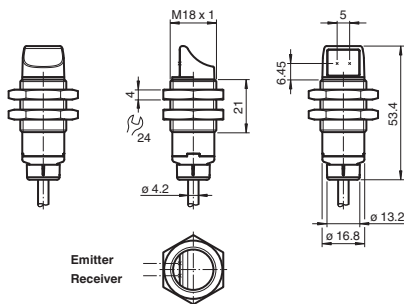

Technical Data

General specifications

| | |
|----------------------------|-----------------------------|
| Effective detection range | 0 ... 5 m |
| Reflector distance | 0 ... 5 m |
| Threshold detection range | 7 m |
| Reference target | reflector C110-2 |
| Light source | LED |
| Light type | modulated visible red light |
| Polarization filter | yes |
| Diameter of the light spot | approx. 270 mm at 5 m |
| Opening angle | approx. 2.6 ° |
| Optical face | lateral |
| Ambient light limit | EN 60947-5-2 40000 Lux |

Functional safety related parameters

Release date: 2022-05-12 Date of issue: 2022-05-12 Filename: 70113328-100099_eng.pdf

Refer to "General Notes Relating to Pepperl+Fuchs Product Information".

Pepperl+Fuchs Group
www.pepperl-fuchs.com

USA: +1 330 486 0001
fa-info@us.pepperl-fuchs.com

Germany: +49 621 776 1111
fa-info@de.pepperl-fuchs.com

Singapore: +65 6779 9091
fa-info@sg.pepperl-fuchs.com

PF PEPPERL+FUCHS

Technical Data

| | | |
|-----------------------------------|----------------|--|
| MTTF _d | | 1552 a |
| Mission Time (T _M) | | 20 a |
| Diagnostic Coverage (DC) | | 0 % |
| Indicators/operating means | | |
| Operation indicator | | LED green: on - power on flashing (4 Hz) - short circuit |
| Function indicator | | Yellow LED: Permanently lit - light path clear Permanently off - object detected Flashing (4 Hz) - insufficient operating reserve |
| Electrical specifications | | |
| Operating voltage | U _B | 10 ... 30 V DC |
| Ripple | | max. 10 % |
| No-load supply current | I ₀ | < 25 mA |
| Protection class | | III |
| Output | | |
| Switching type | | Q - Pin4: PNP normally open / dark-on |
| Signal output | | 1 PNP output, short-circuit protected, reverse polarity protected, open collector |
| Switching voltage | | max. 30 V DC |
| Switching current | | max. 100 mA , resistive load |
| Voltage drop | U _d | ≤ 1.5 V DC |
| Switching frequency | f | 500 Hz |
| Response time | | ≤ 1 ms |
| Conformity | | |
| Product standard | | EN 60947-5-2 |
| Approvals and certificates | | |
| UL approval | | E87056 , cULus Listed , class 2 power supply , type rating 1 |
| Ambient conditions | | |
| Ambient temperature | | -40 ... 60 °C (-40 ... 140 °F) |
| Storage temperature | | -40 ... 70 °C (-40 ... 158 °F) |
| Mechanical specifications | | |
| Degree of protection | | IP67 |
| Connection | | 2 m fixed cable |
| Material | | |
| Housing | | brass, nickel-plated |
| Optical face | | PMMA |
| Cable | | PVC |
| Mass | | approx. 62 g |

Connection

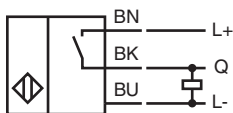

Indication

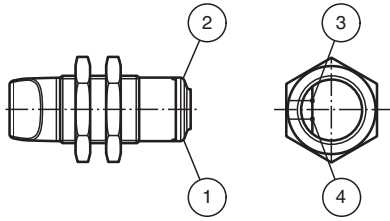

| | | |
|---|-------------------|--------|
| 1 | Operating display | green |
| 2 | Signal display | yellow |
| 3 | Emitter | |
| 4 | Receiver | |

Characteristic Curve

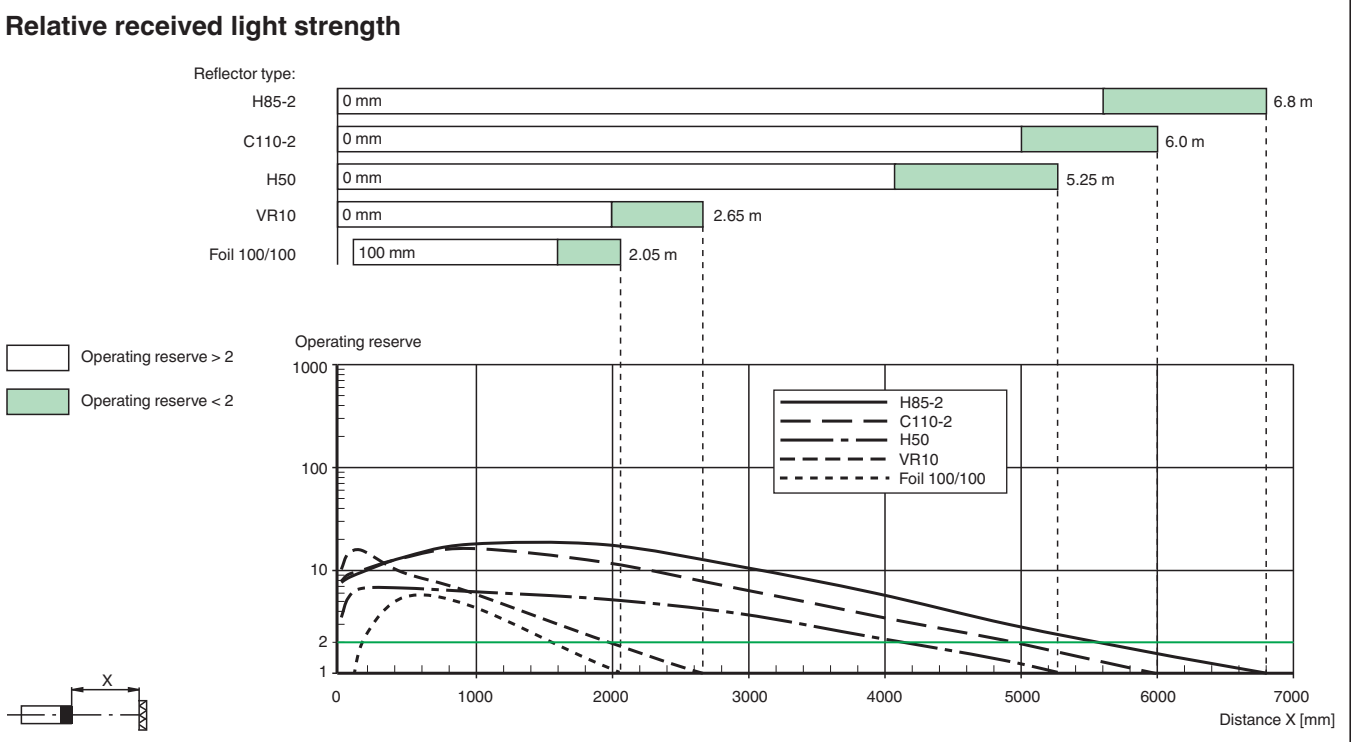
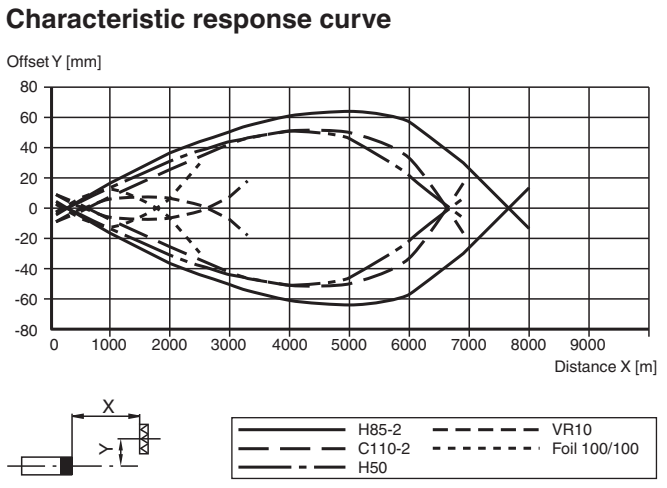









Accessories

| | | |
|--|-----------------|----------------------------------|
| | BF 18 | Mounting flange, 18 mm |
| | CPZ18B03 | Mounting Bracket with swivel nut |

Release date: 2022-05-12 Date of issue: 2022-05-12 Filename: 70113328-100099_eng.pdf

Refer to "General Notes Relating to Pepperl+Fuchs Product Information".

Accessories

| | | |
|---|--------------------|---|
|  | BF 18-F | Plastic mounting adapter, 18 mm |
|  | BF 5-30 | Universal mounting bracket for cylindrical sensors with a diameter of 5 ... 30 mm |
|  | OMH-04 | Mounting aid for round steel \varnothing 12 mm or sheet 1.5 mm ... 3 mm |
|  | REF-H85-2 | Reflector, rectangular 84.5 mm x 84.5 mm, mounting holes |
|  | REF-C110-2 | Reflector, round \varnothing 84 mm, central mounting hole |
|  | REF-H50 | Reflector, rectangular 51 mm x 61 mm, mounting holes, fixing strap |
|  | REF-VR10 | Reflector, rectangular 60 mm x 19 mm, mounting holes |
|  | OFR-100/100 | Reflective tape 100 mm x 100 mm |