



Y connection cable

V3-GR-0,3M-PVC-TEE-0,3M-V3S-GR

- Easy merging of two signals at a single M8 slot
- Snap locking

Y connection cable M8 plug snap-lock straight A-coded 3-pin to 2x M8 socket snap-lock straight A-coded 3-pin, PVC cable grey



Dimensions

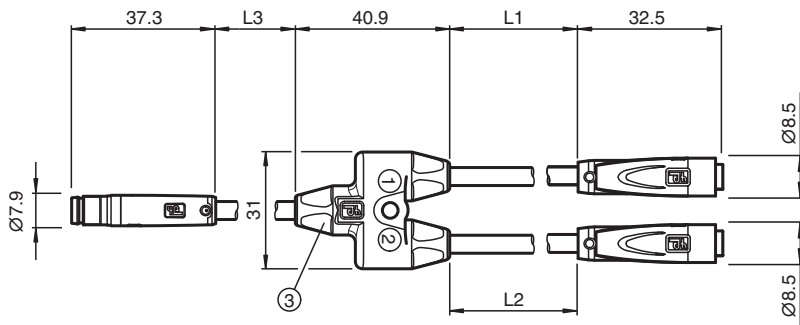

Technical Data

General specifications

Connector 1	
Connection	plug
Construction type	M8
Style	straight
Locking	snap locking
Number of pins	3
Coding	A-coded
Connector 2	
Connection	socket
Construction type	M8
Style	straight
Locking	snap locking
Number of pins	3
Coding	A-coded
Connector 3	
Connection	socket
Construction type	M8
Style	straight
Locking	snap locking
Number of pins	3

Release date: 2023-07-12 Date of issue: 2023-07-12 Filename: 70124923_eng.pdf

Refer to "General Notes Relating to Pepperl+Fuchs Product Information".

Pepperl+Fuchs Group
www.pepperl-fuchs.com

USA: +1 330 486 0001
fa-info@us.pepperl-fuchs.com

Germany: +49 621 776 1111
fa-info@de.pepperl-fuchs.com

Singapore: +65 6779 9091
fa-info@sg.pepperl-fuchs.com

 PEPPERL+FUCHS

Technical Data

Coding	A-coded	
Electrical specifications		
Operating voltage	U_B	max. 48 V AC / 60 V DC
Operating current	I_B	max. 3 A
Conformity		
Degree of protection		EN 60529
Plug connection		connector M8 x 1 : IEC 61076-2-104
Ambient conditions		
Ambient temperature		
Plug connector		-25 ... 90 °C (-13 ... 194 °F)
Cable, fixed		-40 ... 70 °C (-40 ... 158 °F)
Cable, flexing		-5 ... 70 °C (23 ... 158 °F)
Pollution degree		3
Mechanical specifications		
Plug connector		
Mating cycles		min. 100
Degree of protection		IP65
Cable		according to IEC/EN 60228 (DIN VDE 0295) class 5
Sheath diameter		4.3 mm
Bending radius		> 15 x cable diameter, moving > 10 x cable diameter, fixed
Sheath stripping force		max. 80 N / 300 mm
Sheath color		grey (similar to RAL 7001)
Number of cores		3
Core cross section		0.25 mm ²
Cores color		Core 1: brown Core 3: blue Core 4: black
Core construction		14 x 0.15 mm Ø
Length	L	L1 = 300 mm L2 = 300 mm L3 = 300 mm
Cable code		Li YY 3 x 0,25
Material		
Plug connector		
Body		PUR, black
Contact surface		Au
Flammability		V-2
Cable		
Sheathing		PVC
Core insulation		PVC
Flammability		flame-resistant

Connection

