



Vision Sensor

VOS2000-F226W-8MM-I

- Reads all standard 1-D and 2-D codes
- Reads DPM codes
- Multi code reading
- Output string formatting
- Code quality output
- 32 Jobs on-board can be saved
- Offline parameterization
- 1.2 megapixel resolution
- Integrated illumination
- Mechanical focus adjustment

Vision sensor for 1-D and 2-D code reading; Resolution: 1280 x 960 pixels; Light source: integrated LED flash, white; Lens: M12 lens; Focal length: 8 mm



Dimensions

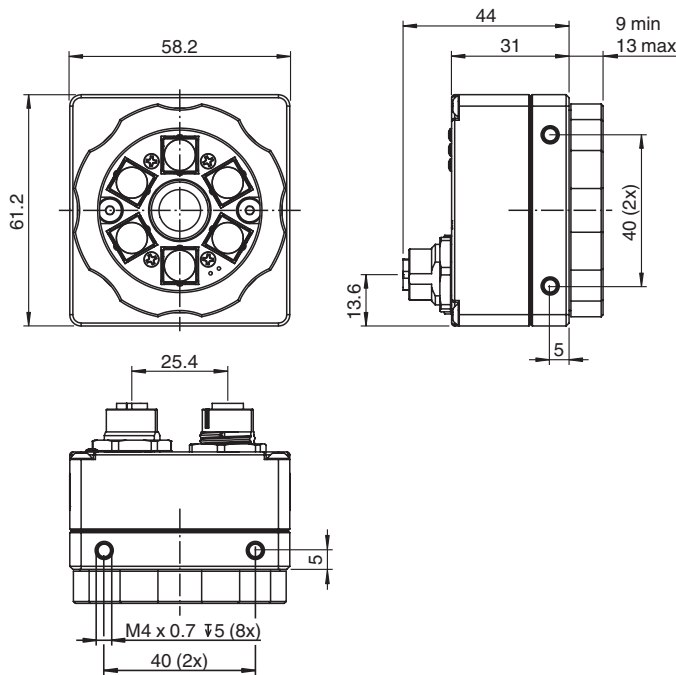

Technical Data

General specifications

Sensing range	55 mm x 41 mm at 100 mm reading distance and min. module size of 0.1 mm (1-D and 2-D barcode) 355 mm x 266 mm at 600 mm reading distance and min. module size of 0.48 mm (1-D barcode) or 0.64 mm (2-D barcode)
Light source	Integrated LED lightning , white
Picture detail	dependant of operating distance

Release date: 2024-03-12 Date of issue: 2024-03-12 Filename: 70129943_eng.pdf

Refer to "General Notes Relating to Pepperl+Fuchs Product Information".

Pepperl+Fuchs Group
www.pepperl-fuchs.com

USA: +1 330 486 0001
fa-info@us.pepperl-fuchs.com

Germany: +49 621 776 1111
fa-info@de.pepperl-fuchs.com

Singapore: +65 6779 9091
fa-info@sg.pepperl-fuchs.com

PEPPERL+FUCHS

Technical Data

Readable codes		1-D Codes: Code 128, Code 39, Int 2 of 5, Codabar, UPC-A/E, EAN-8/13, Code 11, Code 32, Plessey, MSI Plessey, Telepen, BC 412, Pharmacode, DataBar, Postcode, Trioptic 2-D Codes: Data Matrix, QR-Code, Micro QR-Code, PDF417, Micro PDF417, Aztec, Han Xin Code, Maxi Code, Grid Matrix, Dotcode
Trigger mode		Free-running or triggered externally
Depth of focus		± 5 % of the operating distance
Focal length		8 mm
Evaluation frequency		30 Hz
Target velocity		max. 4 m/s
Resolution		1280 x 960 pixels
Image sensor		1/3" CMOS monochrom Global Shutter 3.75 µm pixel size
Lens		M12 integrated lens
Parameterization/software		
Parameter assignment		Parameterization via PC user interface VCT Tool
Evaluation procedure		
Identification and Verification		1-D and 2-D codes
Indicators/operating means		
LED 1		Steady blue: sensor started, not set up Steady green: job loaded, ready for execution Flashing green: job loaded and being executed, capture in progress Steady red: sensor fault
LED 2		Flashing blue: starting (duration approx. 20 seconds) Steady green: measurement successful (Pass) Steady blue: measurement borderline (Recycle) Steady red: measurement unsuccessful (Fail)
LED 3		Steady blue: warm reset or restart Steady red/green/yellow: network activity
Focus setting		Focus adjustable via centering
Electrical specifications		
Operating voltage	U_B	12 ... 30 V DC
No-load supply current	I_0	300 mA
Interface 1		
Interface type		Ethernet
Protocol		PROFINET IO TCP/IP EtherNet/IP
Transfer rate		100 MBit/s
Interface 2		
Interface type		RS-232 , serial
Transfer rate		115.2 kBit/s
Input		
Input type		optically decoupled Inputs
Input voltage		Logic low (OFF): 0 ... 3 V Logic high (ON): 11 ... 30 V Switching threshold: 12 V
Control input		Image capture trigger + 2 general purpose inputs 2 inputs can be used for job switching
Input current		8 mA (typical)
Internal protection circuit		3 kΩ / 4000 V (rms)
Switching delay		Switch-on time (ON): 20 µs Switch-off time (OFF): 10 µs Image capture trigger: 62 µs (until image capture is triggered)
Output		
Output type		3 general purpose outputs , freely programmable , optically decoupled
Switching voltage		max. 30 V
Switching current		max. 100 mA each output

Release date: 2024-03-12 Date of issue: 2024-03-12 Filename: 70129943_eng.pdf

Technical Data

Switching delay	Switch-on time (ON): 150 μ s Switch-off time (OFF): 50 μ s
Standard conformity	
Emitted interference	EN 61000-6-4:2007+A1:2011
Noise immunity	EN 61000-6-2:2005
Approvals and certificates	
Approvals	CE
Ambient conditions	
Ambient temperature	0 ... 50 °C (32 ... 122 °F)
Storage temperature	-20 ... 60 °C (-4 ... 140 °F)
Mechanical specifications	
Degree of protection	IP67
Connection	8-pin M12 socket A-coded ; 12-pin M12 socket
Material	
Housing	anodized aluminum , plastic
Optical face	Plastic pane
Installation	Mounting bracket
Mass	approx. 200 g
Dimensions	
Height	57 mm
Width	58 mm
Length	61 mm

Connection Assignment

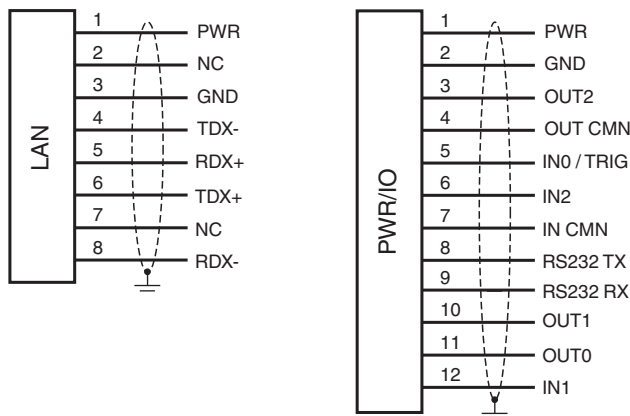

Connection

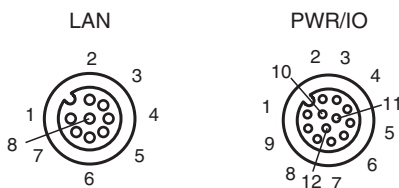

Release date: 2024-03-12 Date of issue: 2024-03-12 Filename: 70129943_eng.pdf

Refer to "General Notes Relating to Pepperl+Fuchs Product Information".