

Connection cable

V1-W-E8-OR5M-PUR-A1-V1-G



- Improved resistance to weld slag
- Suitable for drag chains and abrasion resistant
- Suitable for robotic applications / torsion resistant
- Built-in LED, as operating and function indicator
- Degree of protection IP68 / IP69
- Free of paint wetting interfering substances
- Resistant to microbes and hydrolysis
- UL listed for USA and Canada
- Halogen-free
- Meets the VASS6 standard
- Specific design protects against loosening and inaccurate installation

Cordset M12 socket angled to M12 plug straight A-coded, LED 4-pin, PUR cable welding-bead resistant orange, UL approved, drag chain suitable, torsion resistant



Dimensions

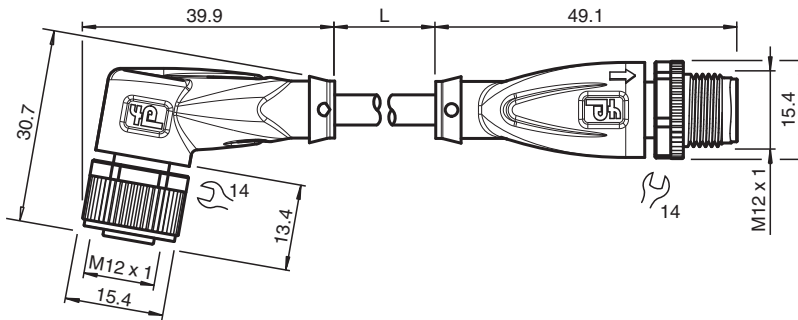

Technical Data

General specifications

Connector 1	
Connection	socket
Construction type	M12
Style	angled
Locking	screw connection
Number of pins	4
Coding	A-coded
Connector 2	
Connection	plug
Construction type	M12
Style	straight
Locking	screw connection
Number of pins	4
Coding	A-coded
Indicators/operating means	
LED green	Operating display
LED yellow	Functional display pin 4
LED red	Functional display pin 2

Release date: 2023-07-13 Date of issue: 2023-07-13 Filename: 70137220-100010_eng.pdf

Refer to "General Notes Relating to Pepperl+Fuchs Product Information".

Pepperl+Fuchs Group
www.pepperl-fuchs.com

USA: +1 330 486 0001
fa-info@us.pepperl-fuchs.com

Germany: +49 621 776 1111
fa-info@de.pepperl-fuchs.com

Singapore: +65 6779 9091
fa-info@sg.pepperl-fuchs.com

PEPPERL+FUCHS

Technical Data

Electrical specifications		
Operating voltage	U _B	max. 24 V DC -20 % / +25 %
Operating current	I _B	max. 4 A
Conformity		
Degree of protection		EN 60529
Plug connection		connector M12 x 1 : IEC 61076-2-101
Flammability		UL 1581; DIN EN 60332-2-2
PWIS conformity		VW-PV 3.10.7
Halogen-free		DIN VDE 0472-815
Oil resistance		DIN EN 60811-2-1
Approvals and certificates		
UL approval		AWM STYLE 20549 AWM I/II A/B 80°C 300V FT2 (cable)
UL File Number		E231213
Ambient conditions		
Ambient temperature		
Plug connector		-40 ... 90 °C (-40 ... 194 °F)
Cable, fixed		-40 ... 80 °C (-40 ... 176 °F)
Cable, flexing		-25 ... 80 °C (-13 ... 176 °F)
Pollution degree		3
Mechanical specifications		
Plug connector		
Tightening torque		0.6 Nm
Loosening protection		available
Tool installation		straight knurling and hexagon nut SW = 14 mm
Mating cycles		min. 100
Degree of protection		IP68 / IP69
Cable		
Sheath diameter		4.9 mm
Bending radius		> 10 x cable diameter, moving > 5 x cable diameter, fixed
Sheath stripping force		max. 80 N / 300 mm
Sheath color		orange (similar to RAL 2003)
Number of cores		4
Core cross section		0.34 mm ²
Cores color		Core 1: brown Core 2: white Core 3: blue Core 4: black
Core construction		42 x 0.1 mm Ø
Length	L	5 m
Cable code		Li F 9Y 11Y 4 x 0,34
Drag chain suitability		
Drag chain cycles		min. 5000000
Motion velocity		max. 3 m/s
Traverse distance		max. 5 m
Acceleration		max. 5 m/s ²
Torsion cycles		min. 1000000
Torsional stress		± 180 °/m
Material		
PWIS free		yes
Halogen-free		yes
Plug connector		
Screw connection		Zinc diecast, nickel-plated
Body		TPU, transparent/black

Release date: 2023-07-13 Date of issue: 2023-07-13 Filename: 70137220-100010_eng.pdf

Refer to "General Notes Relating to Pepperl+Fuchs Product Information".

Pepperl+Fuchs Group
www.pepperl-fuchs.com

USA: +1 330 486 0001
fa-info@us.pepperl-fuchs.com

Germany: +49 621 776 1111
fa-info@de.pepperl-fuchs.com

Singapore: +65 6779 9091
fa-info@sg.pepperl-fuchs.com

 PEPPERL+FUCHS





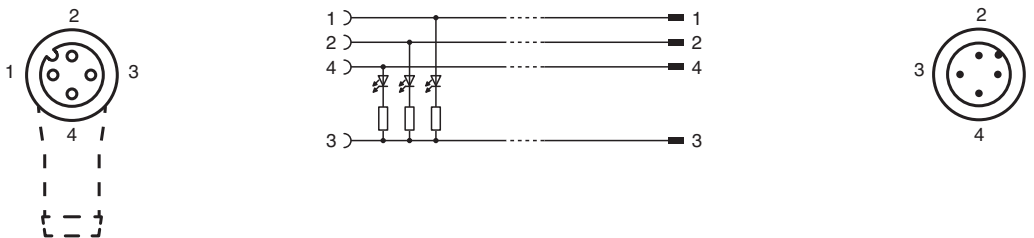

Technical Data

Seal	FKM
Contact surface	gold plated (Au)
Flammability	V-2
Cable	
Sheathing	PUR based on polyether
Core insulation	PP
Welding-bead resistance	yes
Weld spatter resistance	yes
Chemical resistance	good
Oil resistance	yes
Cooling lubricant resistance	yes
Microbial resistance	yes
Hydrolysis resistance	yes
Flammability	FT2

Connection



Accessories

	MH V1-SCREWDRIVER	Torque screwdriver (0.6 Nm)
	MH V1-BIT M12	plug-in cap M12
	V1/V3-LABELHOLDER	Label holder
	V1/V3-LABEL	Label plate
	MH V1-Holder	Modular universal holder for M12 connectors
	V1-CLIP	Unlocking protector for M12 connector
	V1-MARKING-RING-COLOR	Marking rings for M12 connectors, various colors

Release date: 2023-07-13 Date of issue: 2023-07-13 Filename: 70137220-100010_eng.pdf