



# Fiber optic sensor

## SU18-16/40a/102/115/126a



- Basic line for DIN rail installation
- Sleek design
- 3 response times selectable
- High switching frequency
- Self diagnosis function

Fiber optic sensor for glass fiber optics and plastic fiber optics



### Dimensions

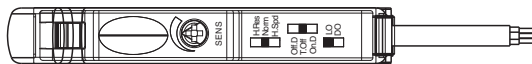
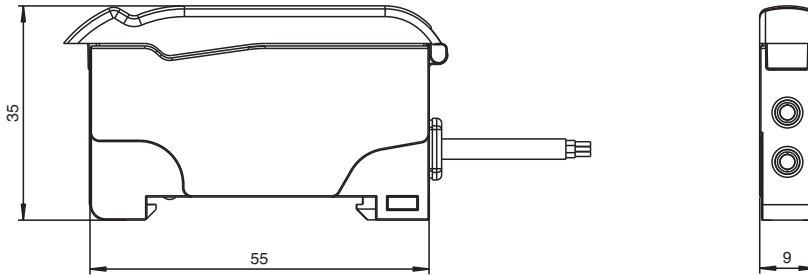

H.Res = High Resolution  
 Norm = Normal  
 H.Spd = High Speed  
 Off.D = Off Delay  
 T.Off = Timer off  
 On.D = On Delay  
 LO = Light on  
 DO = Dark on

### Technical Data

#### General specifications

Sensor range	up to 150 mm (KLR-C02-2,2-2,0-K146)
Detection range	up to 450 mm (KLE-C01-2,2-2,0-K116)
Light source	LED
Light type	modulated visible red light , 660 nm
Ambient light limit	10000 Lux

#### Functional safety related parameters

MTTF <sub>d</sub>	690 a
Mission Time (T <sub>M</sub> )	20 a
Diagnostic Coverage (DC)	0 %

Release date: 2023-07-21 Date of issue: 2023-07-21 Filename: 803585\_eng.pdf

Refer to "General Notes Relating to Pepperl+Fuchs Product Information".

Pepperl+Fuchs Group  
 www.pepperl-fuchs.com

USA: +1 330 486 0001  
 fa-info@us.pepperl-fuchs.com

Germany: +49 621 776 1111  
 fa-info@de.pepperl-fuchs.com

Singapore: +65 6779 9091  
 fa-info@sg.pepperl-fuchs.com

**PF** PEPPERL+FUCHS

## Technical Data

<b>Indicators/operating means</b>		
Operation indicator		LED green, statically lit Power on , Undervoltage indicator: Green LED, pulsing (approx. 0.8 Hz) , short-circuit : LED green flashing (approx. 4 Hz)
Function indicator		LED yellow: static illumination switching state, flashes when falling short of the operating reserve
Control elements		Potentiometer for setting sensitivity slide switch 2 positions: light/dark switching slide switch 3 positions: timer function - timer off, on delay 40 ms, off-delay 40 ms slide switch 3 positions: operating mode - normal, high speed , high resolution
<b>Electrical specifications</b>		
Operating voltage	$U_B$	10 ... 30 V DC
Ripple		10 %
No-load supply current	$I_0$	≤ 30 mA
<b>Output</b>		
Stability alarm output		1 NPN, short-circuit protected open collector
Switching type		light/dark on, switchable
Signal output		1 NPN, short-circuit protected open collector
Switching voltage		max. 30 V DC
Switching current		max. 100 mA , resistive load
Voltage drop	$U_d$	≤ 2 V DC at 100 mA ; ≤ 0.7 V at 10 mA
Switching frequency	$f$	Standard mode: 3 kHz , High speed mode: 6 kHz , High resolution: 250 Hz
Response time		Standard mode: 160 μs , High speed mode: 80 μs , High resolution: 2 ms
Repeat accuracy	$R$	≤ 0.5 % of adjusted sensor range
<b>Conformity</b>		
Product standard		EN 60947-5-2
<b>Approvals and certificates</b>		
UL approval		cULus Listed, Class 2 Power Source, Type 1 enclosure
CCC approval		CCC approval / marking not required for products rated ≤36 V
<b>Ambient conditions</b>		
Ambient temperature		-10 ... 55 °C (14 ... 131 °F)
Storage temperature		-20 ... 70 °C (-4 ... 158 °F)
<b>Mechanical specifications</b>		
Housing width		9 mm
Housing height		34.5 mm
Housing depth		62.3 mm
Degree of protection		IP50
Connection		2 m PVC cable, 4 x 0,14 mm <sup>2</sup>
Material		
Housing		PC
Mass		45 g

Release date: 2023-07-21 Date of issue: 2023-07-21 Filename: 803585\_eng.pdf

Refer to "General Notes Relating to Pepperl+Fuchs Product Information".

Pepperl+Fuchs Group  
www.pepperl-fuchs.comUSA: +1 330 486 0001  
fa-info@us.pepperl-fuchs.comGermany: +49 621 776 1111  
fa-info@de.pepperl-fuchs.comSingapore: +65 6779 9091  
fa-info@sg.pepperl-fuchs.com

**PEPPERL+FUCHS**

**Connection Assignment**

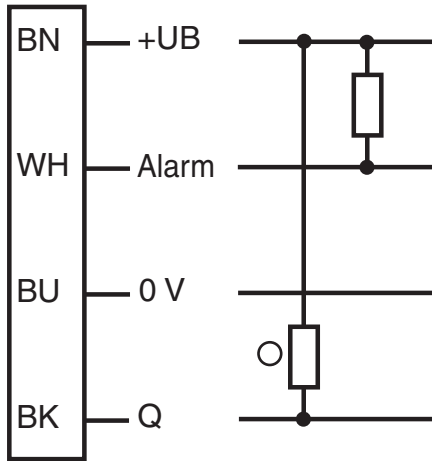

○ = Light on  
● = Dark on

**Characteristic Curve**

**Self-Diagnostic definition and operation:**

5 sec. rule for light-ON (LO) and dark-ON (DO) mode

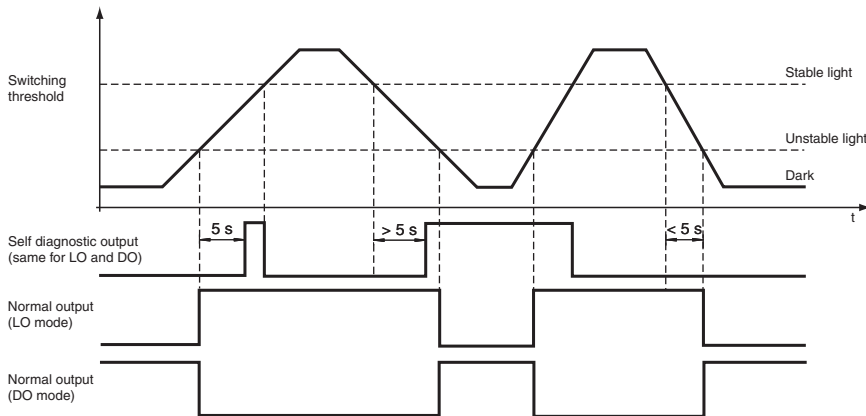

8 cyc. rule for light-ON (LO) and dark-ON (DO) mode

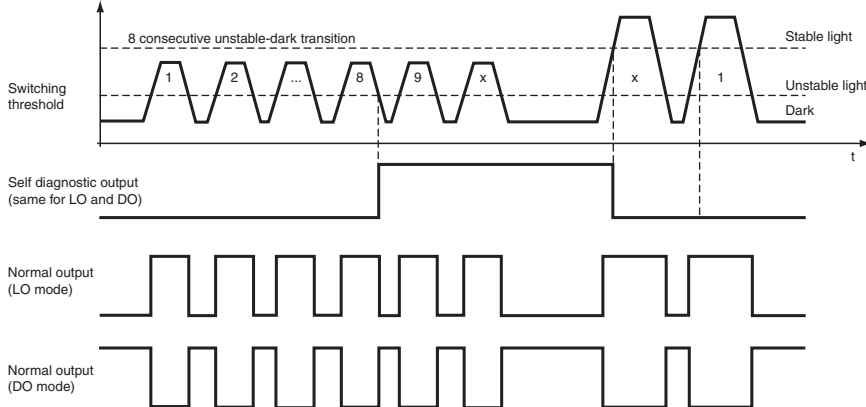

Release date: 2023-07-21 Date of issue: 2023-07-21 Filename: 803585\_eng.pdf

## Characteristic Curve

### LED indicators and operating chart:

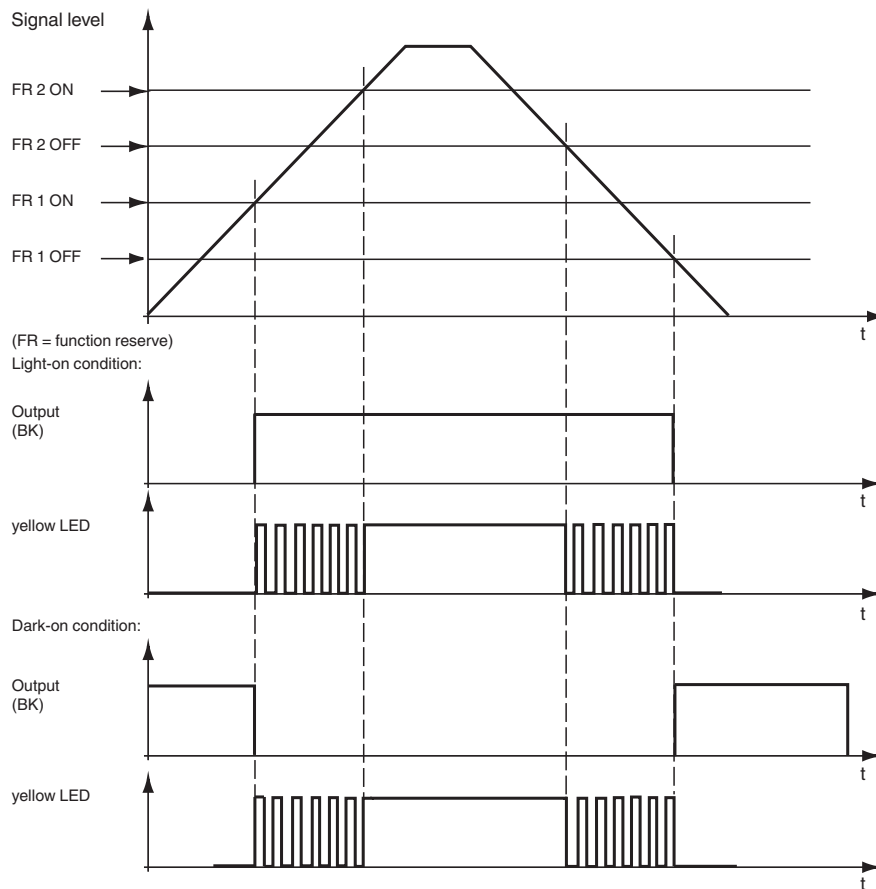











## Accessories

	<b>KLR-C02-2,2-2,0-K146</b>	Plastic fiber optic - diffuse
	<b>KLR-C02-2,2-2,0-K70</b>	Plastic fiber optic - diffuse
	<b>KLR-C02-1,0-2,0-K75</b>	Plastic fiber optic - diffuse
	<b>KLR-C09-1,25-2,0-K76</b>	Plastic fiber optic - diffuse
	<b>KLR-C09-1,25-2,0-K74</b>	Plastic fiber optic - diffuse
	<b>KLR-C16-2,2-2,0-K71</b>	Plastic fiber optic - diffuse
	<b>KLR-A32-2,2-2,0-K83</b>	Plastic fiber optic - diffuse
	<b>KHR-C02-2,2-2,0-K131</b>	Plastic fiber optic - diffuse

Release date: 2023-07-21 Date of issue: 2023-07-21 Filename: 803585\_eng.pdf

**Accessories**

	<b>KHTR-C02-2,2-2,0-K88</b>	Plastic fiber optic - diffuse
	<b>KLE-C01-2,2-2,0-K116</b>	Plastic fiber optic - thru-beam
	<b>KLE-C01-2,2-2,0-K103</b>	Plastic fiber optic - thru-beam
	<b>KLE-C01-2,2-2,0-K102</b>	Plastic fiber optic - thru-beam
	<b>KLE-C01-2,2-2,0-K101</b>	Plastic fiber optic - thru-beam
	<b>KLE-C01-2,2-2,0-K113</b>	Plastic fiber optic - thru-beam
	<b>KLE-C01-1,0-2,0-K120</b>	Plastic fiber optic - thru-beam
	<b>KHE-C01-2,2-2,0-K122</b>	Plastic fiber optic - thru-beam
	<b>KHTE-C01-2,2-2,0-K118</b>	Plastic fiber optic - thru-beam
	<b>LHE 00-1,1-1,0-20M4</b>	Glass fiber optic - thru-beam with silicon covering

Release date: 2023-07-21 Date of issue: 2023-07-21 Filename: 803585\_eng.pdf

Refer to "General Notes Relating to Pepperl+Fuchs Product Information".

Pepperl+Fuchs Group  
www.pepperl-fuchs.com

USA: +1 330 486 0001  
fa-info@us.pepperl-fuchs.com

Germany: +49 621 776 1111  
fa-info@de.pepperl-fuchs.com

Singapore: +65 6779 9091  
fa-info@sg.pepperl-fuchs.com

**Selection table - thru-beam fiber optic cable**

Head shape	Mounting	Model number	Core	Detection distance	Fiber cross section	minimum Object size	Fiber optic length	Bend radius	Dimensions	Special features
<b>Highly precise</b>										
Threaded	M3	KLE-C01-1.0-2.0-K120	PMMA	20 mm	0.25 mm	0.05 mm	2 m	min. 10 mm		
Threaded	M4	KLE-C01-1.0-2.0-K119	PMMA	20 mm	0.25 mm	0.05 mm	2 m	min. 10 mm		4 x high Detection range with Auxiliary lens K-LA01/ 8 x high Detection range with Auxiliary lens K-LA06/ Side view / Periscope with K-LA02
Threaded	M3 x 0.5	KLE-C04-1.0-2.0-K104	PMMA	70 mm	4 x 0.25 mm	0.12 mm	2 m	min. 15 mm		
Cylindrical	dia. 2 mm	KLE-C01-1.0-2.0-K105	PMMA	20 mm	0.25 mm	0.05 mm	2 m	min. 10 mm		
Cylindrical	dia. 1.5 mm	KLE-C01-1.0-2.0-K107	PMMA	20 mm	0.25 mm	0.05 mm	2 m	min. 10 mm		
Cylindrical	dia. 1.5 mm	KLE-C04-1.0-2.0-K108	PMMA	70 mm	4 x 0.25 mm	0.12 mm	2 m	min. 15 mm		
Cylindrical	dia. 2 mm	KLE-C04-1.0-2.0-K106	PMMA	70 mm	4 x 0.25 mm	0.05 mm	2 m	min. 15 mm		
<b>Highly flexible</b>										
Threaded	M3	KHE-C01-1.0-2.0-K125	PMMA	50 mm	0.5 mm	0.15 mm	2 m	min. 1 mm		only 1 mm Bend radius
Threaded	M3	KHE-C01-2.2-2.0-K122	PMMA	200 mm	1 mm	0.25 mm	2 m	min. 2 mm		only 2 mm Bend radius
Threaded	M4 x 0.7 / M2.6	KHE-C01-1.0-2.0-K124	PMMA	50 mm	0.5 mm	0.15 mm	2 m	min. 1 mm		4 x high Detection range with Auxiliary lens K-LA01/ 8 x high Detection range with Auxiliary lens K-LA06/ Side view / Periscope with K-LA02/ only 1 mm Bend radius

Release date: 2023-07-21 Date of issue: 2023-07-21 Filename: 803585\_eng.pdf

Refer to "General Notes Relating to Pepperl+Fuchs Product Information".

Pepperl+Fuchs Group  
www.pepperl-fuchs.com

USA: +1 330 486 0001  
fa-info@us.pepperl-fuchs.com

Germany: +49 621 776 1111  
fa-info@de.pepperl-fuchs.com

Singapore: +65 6779 9091  
fa-info@sg.pepperl-fuchs.com

PEPPERL+FUCHS

Head shape	Mounting	Model number	Core	Detection distance	Fiber cross section	minimum Object size	Fiber optic length	Bend radius	Dimensions	Special features
Threaded	M6	KHE-C01-2.2-2.0-K121	PMMA	200 mm	1.0 mm	0.25 mm	2 m	min. 2 mm		only 2 mm Bend radius
Cylindrical	dia. 1.5 mm	KHE-C01-1.0-2.0-K139	PMMA	50 mm	0.5 mm	0.05 mm	2 m	min. 1 mm		only 1 mm Bend radius
Cylindrical	dia. 3 mm	KHE-C01-2.2-2.0-K126	PMMA	50 mm	0.5 mm	0.15 mm	2 m	min. 1 mm		only 1 mm Bend radius
Cylindrical	dia. 3 mm	KHE-C01-2.2-2.0-K123	PMMA	200 mm	1 mm	0.25 mm	2 m	min. 2 mm		only 2 mm Bend radius
Right angle	dia. 15 x 5	KHE-C01-2.2-2.0-K137	PMMA	35 mm	0.5 mm	0.15 mm	2 m	min. 1 mm		only 1 mm Bend radius
Right angle	dia. 15 x 5	KHE-C01-2.2-2.0-K140	PMMA	150 mm	1 mm	0.25 mm	2 m	min. 2 mm		only 2 mm Bend radius
Flexible										
Threaded	M3 x 0.5 /M2.6	KLE-C01-1.3-2.0-K112	PMMA	200 mm	1 mm	0.25 mm	2 m	min. 25 mm		4 x high Detection range with Auxiliary lens K-LA01/ 8 x high Detection range with Auxiliary lens K-LA06 Side view / Periscope with K-LA02
Threaded	M3 x 0.5	KLE-C01-2.2-2.0-K103	PMMA	220 mm	1 mm	0.25 mm	2 m	min. 25 mm		
Threaded	M4 x 0.7 /M2.6	KLE-C01-2.2-2.0-K102	PMMA	220 mm	1 mm	0.25 mm	2 m	min. 25 mm		4 x high Detection range with Auxiliary lens K-LA01/ 8 x high Detection range with Auxiliary lens K-LA06 Side view / Periscope with K-LA02
Threaded	M6	KLE-C01-2.2-2.0-K100	PMMA	220 mm	1 mm	0.32 mm	2 m	min. 25 mm		
Threaded	M2.6	KLE-C01-2.2-2.0-K113	PMMA	200 mm	1 mm	0.25 mm	2 m	min. 25 mm		4 x high Detection range with Auxiliary lens K-LA01/ 8 x high Detection range with Auxiliary lens K-LA06 Side view / Periscope with K-LA02

Release date: 2023-07-21 Date of issue: 2023-07-21 Filename: 803585\_eng.pdf

Refer to "General Notes Relating to Pepperl+Fuchs Product Information".

Pepperl+Fuchs Group  
www.pepperl-fuchs.com

USA: +1 330 486 0001  
fa-info@us.pepperl-fuchs.com

Germany: +49 621 776 1111  
fa-info@de.pepperl-fuchs.com

Singapore: +65 6779 9091  
fa-info@sg.pepperl-fuchs.com

PEPPERL+FUCHS

Head shape	Mounting	Model number	Core	Detection distance	Fiber cross section	minimum Object size	Fiber optic length	Bend radius	Dimensions	Special features
Cylindrical	dia. 2 mm	KLE-C01-1.3-2.0-K114	PMMA	220 mm	1 mm	0.25 mm	2 m	min. 25 mm		
Cylindrical	dia. 5 mm	KLE-C01-2.2-2.0-K101	PMMA	220 mm	1 mm	0.32 mm	2 m	min. 25 mm		
Bendable tip										
Threaded	M4	KLE 00-2.2-2.0-K55	PMMA	228 mm	1 mm		2 m	min. 25 mm		
High detection range										
Threaded	M3	KLE-C01-2.2-2.0-K116	PMMA	450 mm	1.5 mm	0.35 mm	2 m	min. 40 mm		
Threaded	M6	KLE-C01-2.2-2.0-K115	PMMA	450 mm	1.5 mm	0.35 mm	2 m	min. 40 mm		
Threaded	M8 x 1	FEF-PLT1	PMMA	6000 mm calculated value related on 2 m Fiber optic length	1 mm		1 m	min. 25 mm		Narrow beam
Threaded	M8 x 1	FEF-PLT1-L2	PMMA	6000 mm calculated value related on 2 m Fiber optic length	1 mm		2 m	min. 25 mm		Narrow beam
Threaded	M8 x 1	FEF-PLT1-L5	PMMA	6000 mm calculated value related on 2 m Fiber optic length	1 mm		4 m	min. 25 mm		Narrow beam
Cylindrical	dia. 3 mm	KLE-C01-2.2-2.0-K117	PMMA	400 mm	1.5 mm	0.35 mm	2 m	min. 25 mm		
Side view / Periscope										
Cylindrical	dia. 4.75 mm	KHE-C01-2.2-2.0-K136	PMMA	50 mm	0.5 mm	0.15 mm	2 m	min. 1 mm		only 1 mm Bend radius
Array										

Release date: 2023-07-21 Date of issue: 2023-07-21 Filename: 803585\_eng.pdf



Head shape	Mounting	Model number	Core	Detection distance	Fiber cross section	minimum Object size	Fiber optic length	Bend radius	Dimensions	Special features
Rectangular	3 x M2 x 0.5	KLE-A16-2.2-2.0-K109	PMMA	100 mm	16 x 0.25 mm	0.05 mm	2 m	min. 25 mm		
Rectangular	3 x M3 x 0.5	KLE-A16-2.2-2.0-K110	PMMA	100 mm	16 x 0.25 mm	0.05 mm	2 m	min. 25 mm		
Rectangular	3 x M3 x 0.5	KLE-A16-2.2-2.0-K111	PMMA	100 mm	16 x 0.25 mm	0.05 mm	2 m	min. 25 mm		
Rectangular	2 x 3.2 mm	KLE-A32-2.2-2.0-K142	PMMA	35 mm	32 x 0.25 mm		2 m	min. 25 mm		
High temperature resistance										
Cylindrical	dia. 3 mm	KHTE-C01-2.2-2.0-K118	PMMA	115 mm	1 mm	0.35 mm	2 m	min. 25 mm		-55°C ... + 115°C
Sturdy design										
Threaded	M3	LHE 00-1.1-1.0-14M3	glass	195 mm	1.1 mm		1 m	4 mm static		-40°C ... + 180°C
Threaded	M4 x 0.7 / M2.6	LHE 00-1.1-1.0-20M4	glass	195 mm	1.1 mm		1 m	4 mm static		4 x high Detection range with Auxiliary lens K-LA01/ 8 x high Detection range with Auxiliary lens K-LA06 Side view / Periscope with K-LA02/ -40°C ... + 180°C
Threaded	M6	LHE 00-1.1-1.0-G	glass	195 mm	1.1 mm		1 m	4 mm static		-40°C ... + 180°C
Cylindrical	dia. 1.5 mm	LHE 00-1.1-1.0-10C1.5	glass	195 mm	1.1 mm		1 m	4 mm static		-40°C ... + 180°C
Cylindrical	dia. 3 mm	LHE 00-1.1-1.0-15C3	glass	195 mm	1.1 mm		1 m	4 mm static		-40°C ... + 180°C
Right angle	Bar 3 mm	LHE 00-1.1-1.0-WC3	glass	195 mm	1.1 mm		1 m	4 mm static		-40°C ... + 180°C

Release date: 2023-07-21 Date of issue: 2023-07-21 Filename: 803585\_eng.pdf

Refer to "General Notes Relating to Pepperl+Fuchs Product Information".

Pepperl+Fuchs Group  
www.pepperl-fuchs.com

USA: +1 330 486 0001  
fa-info@us.pepperl-fuchs.com

Germany: +49 621 776 1111  
fa-info@de.pepperl-fuchs.com

Singapore: +65 6779 9091  
fa-info@sg.pepperl-fuchs.com

PEPPERL+FUCHS

Head shape	Mounting	Model number	Core	Detection distance	Fiber cross section	minimum Object size	Fiber optic length	Bend radius	Dimensions	Special features
Right angle	Bar 10 mm	LHE-00-1.1-1.0-K9	glass	195 mm	1.1 mm		1 m	4 mm static		- 40°C ... + 180 °C
Special design										
Rectangular	2 x 2.2 m m	KHE-A01-1.0-2.0-K138	PMMA	25 mm	0.5 mm	0.05 mm	2 m	min. 1 mm		only 1 mm Bend radius
Slot	2 x 3.2 m m	KLE-C02-1.25-2.0-K134	PMMA	5 mm	2 x 0.25 m m		2 m	min. 10 mm		
Slot	2 x 3.2 m m	KLE-C02-1.25-2.0-K135	PMMA	10 mm	2 x 0.25 m m		2 m	min. 10 mm		

### Diffuse Mode Sensor Selection Table

Head type	Mounting	Designation	Core	Sensing range	Fiber cross-section	Length of fiber optics	Bending radius	Dimensional drawing	Special Properties	
High-precision										
Thread	M3 x 0.5	KLR-C02-1.0-2.0-K75	PMMA	4 mm	2 x 0.25 m	2 m	At least 10 mm			
Thread	M4 x 0.7	KLR-C02-1.0-2.0-K73	PMMA	4 mm	2 x 0.25 mm	2 m	At least 10 mm			
Thread	M3 x 0.5	KLR-C04-1.25-2.0-K78	PMMA	8 mm	4 x 0.25 m	2 m	At least 15 mm			
Cylindrical	Dia. 2.0 mm	KLR-C02-1.0-2.0-K91	PMMA	4 mm	2 x 0.25 mm	2 m	At least 10 mm			
Cylindrical	Dia. 3.0 mm	KLR-C02-1.0-2.0-K90	PMMA	4 mm	2 x 0.25 mm	2 m	At least 10 mm			

Release date: 2023-07-21 Date of issue: 2023-07-21 Filename: 803585\_eng.pdf

Refer to "General Notes Relating to Pepperl+Fuchs Product Information".

Head type	Mounting	Designation	Core	Sensing range	Fiber cross-section	Length of fiber optics	Bending radius	Dimensional drawing	Special Properties
Cylindrical	Dia. 1.5 mm	KLR-C04-1.25-2.0-K80	PMMA	8 mm	4 x 0.25 mm	2 m	At least 15 mm		
Cylindrical	Dia. 1.5 mm	KLR-C04-1.0-2.0-K133	PMMA	7 mm	4 x 0.25 mm	2 m	At least 15 mm		
Cylindrical	Dia. 2.0 mm	KLR-C02-1.0-2.0-K87	PMMA	25 mm	2 x 0.5 mm	2 m	At least 15 mm		
Cylindrical	Dia. 3.0 mm	KLR-C04-1.25-2.0-K79	PMMA	8 mm	4 x 0.25 mm	2 m	At least 15 mm		
Coaxial									
Thread	M3 x 0.5	KLR-C09-1.25-2.0-K76	PMMA	30 mm	1 x 0.5 mm emitter 9 x 0.25 mm receiver	2 m	At least 15 mm		Only 0.5 mm light spot at 8 mm With auxiliary lens K-LA03
Thread	M4 x 0.7 /M2.6	KLR-C09-1.25-2.0-K74	PMMA	30 mm	1 x 0.5 mm emitter 9 x 0.25 mm receiver	2 m	At least 15 mm		Only 0.7 mm light spot at 10 mm with auxiliary lens K-LA04/ two times higher detection range with auxiliary lens K-LA01/ three times higher detection range with auxiliary lens K-LA06
Thread	M6 x 0.75	KLR-C16-2.2-2.0-K71	PMMA	85 mm	1 x 1.0 mm emitter 16 x 0.25 mm receiver	2 m	At least 25 mm		
Cylindrical	Dia. 1.0 mm	KLR-C06-1.25-2.0-K81	PMMA	20 mm	1 x 0.25 mm emitter 6 x 0.25 mm receiver	2 m	At least 15 mm		
Cylindrical	Dia. 3.0 mm	KLR-C09-1.25-2.0-K77	PMMA	30 mm	1 x 0.5 mm emitter 9 x 0.25 mm receiver	2 m	At least 15 mm		
Cylindrical	Dia. 5.0 mm	KLR-C16-2.2-2.0-K72	PMMA	85 mm	1 x 1.0 mm emitter 16 x 0.25 mm Receiver	2 m	At least 25 mm		
Highly flexible									
Thread	M3	KHR-C02-1.0-2.0-K96	PMMA	12 mm	2 x 0.5 mm	2 m	At least 1 mm		

Release date: 2023-07-21 Date of issue: 2023-07-21 Filename: 803585\_eng.pdf

Refer to "General Notes Relating to Pepperl+Fuchs Product Information".

Pepperl+Fuchs Group  
www.pepperl-fuchs.com

USA: +1 330 486 0001  
fa-info@us.pepperl-fuchs.com

Germany: +49 621 776 1111  
fa-info@de.pepperl-fuchs.com

Singapore: +65 6779 9091  
fa-info@sg.pepperl-fuchs.com

PEPPERL+FUCHS

Head type	Mounting	Designation	Core	Sensing range	Fiber cross-section	Length of fiber optics	Bending radius	Dimensional drawing	Special Properties
Thread	M4	KHR-C02-1.0-2.0-K95	PMMA	12 mm	2 x 0.5 mm	2 m	At least 1 mm		
Thread	M4	KHR-C02-1.3-2.0-K92	PMMA	60 mm	2 x 1.0 mm	2 m	At least 2 mm		
Thread	M6	KHR-C02-2.2-2.0-K94	PMMA	12 mm	2 x 0.5 mm	2 m	At least 1 mm		
Cylindrical	Dia. 3.0 mm	KHR-C02-1.3-2.0-K93	PMMA	60 mm	2 x 1.0 mm	2 m	At least 2 mm		
Flexible									
Thread	M6 x 0.75	KLR-C02-2.2-2.0-K70	PMMA	80 mm	2 x 1.0 mm	2 m	At least 25 mm		
Cylindrical	Dia. 3.0 mm	KLR-C02-1.3-2.0-K86	PMMA	80 mm	2 x 1.0 mm	2 m	At least 25 mm		
Cylindrical	Dia. 5.0 mm	KLR-C02-2.2-2.0-K85	PMMA	80 mm	2 x 1.0 mm	2 m	At least 25 mm		
Flexible tip									
Thread	M3 x 0.5	KLR 00-1.0-2.0-K58	PMMA	20 mm		2 m	At least 15 mm		
Thread	M6	KLR 00-2.2-2.0-K57	PMMA	60 mm		2 m	At least 15 mm		
Long detection range									
Thread		KLR-C02-2.2-2.0-K146	PMMA	150 mm		2 m	At least 40 mm		

Release date: 2023-07-21 Date of issue: 2023-07-21 Filename: 803585\_eng.pdf

Head type	Mounting	Designation	Core	Sensing range	Fiber cross-section	Length of fiber optics	Bending radius	Dimensional drawing	Special Properties
Thread		KLR-C10-1.25-2.0-K144	PMMA	30 mm		2 m	At least 15 mm		
Lateral optical face									
Thread	M6	KHR-C02-2.2-2.0-K131	PMMA	60 mm	2 x 1.0 mm	2 m	At least 2 mm		Only 2 mm bending radius
Thread	Dia. 5.0 mm	KHR-C02-1.0-2.0-K132	PMMA	15 mm	2 x 0.5 mm	2 m	At least 1 mm		Only 1 mm bending radius
Array									
Cubic	3 x M2 x 0.5	KLR-A18-1.3-2.0-K82	PMMA	25 mm	18 x 0.25 mm	2 m	At least 25 mm		
Cubic	3 x M3 x 0.5	KLR-A32-2.2-2.0-K83	PMMA	35 mm	10.85 mm	2 m	At least 25 mm		
Cubic	2 x 3.2 mm	KLR-A32-2.2-2.0-K141	PMMA	35 mm	16 x 0.25 mm	2 m	At least 25 mm		
Resistant to high temperatures									
Thread	M6	KHTR-C02-2.2-2.0-K88	PMMA	80 mm	2 x 1.0 mm	2 m	At least 25 mm		-55 °C ... +115 °C
Cylindrical	Dia. 5.0 mm	KHTR-C02-2.2-2.0-K89	PMMA	80 mm	2 x 1.0 mm	2 m	At least 25 mm		-55 °C ... +115 °C
Robust design									
Thread	M3 x 0.5	LHR 00-0.8-1.0-14M3	Glass	40 mm	0.8 mm	1 m	4 mm static		-40 °C ... +180 °C
Thread	M4 x 0.7	LHR 00-0.8-1.0-20M4	Glass	40 mm	0.8 mm	1 m	4 mm static		-40 °C ... +180 °C

Release date: 2023-07-21 Date of issue: 2023-07-21 Filename: 803585\_eng.pdf

Refer to "General Notes Relating to Pepperl+Fuchs Product Information".

Pepperl+Fuchs Group  
www.pepperl-fuchs.com

USA: +1 330 486 0001  
fa-info@us.pepperl-fuchs.com

Germany: +49 621 776 1111  
fa-info@de.pepperl-fuchs.com

Singapore: +65 6779 9091  
fa-info@sg.pepperl-fuchs.com

PEPPERL+FUCHS

Head type	Mounting	Designation	Core	Sensing range	Fiber cross-section	Length of fiber optics	Bending radius	Dimensional drawing	Special Properties
Thread	M6	LHR 00-1.1-1.0-G	Glass	70 mm	1.1 mm	1 m	4 mm static		-40 °C ... + 180 °C
Cylindrical	Dia. 4.5 mm	LHR 00-1.1-1.0-K1	Glass	70 mm	1.1 mm	1 m	4 mm static		-40 °C ... + 180 °C
Special design									
Cubic		KHR-C02-1.0-2.0-K129	PMMA	5 ~ 10 mm	2 x 0.5 mm	2 m	At least 1 mm		Crossed light beam for background suppression Only 1 mm bending radius
Cubic		KLR-C02-1.3-2.0-K130	PMMA	1 ~ 8 mm	2 x 1.0 mm	2 m	At least 25 mm		Crossed light beam for background suppression
Cubic	3 x M3 x 0.5	KHR-A02-2.2-2.0-K127	PMMA	50 mm	2 x 1.0 mm	2 m	At least 2 mm		Only 2 mm bending radius
Cubic		KLR-C02-1.25-2.0-K128	PMMA	4 ~ 26 mm	2 x 0.5 mm	2 m	At least 15 mm		Fill level measurement
Cylindrical		KLR-C02-1.25-2.0-K147	PMMA			2 m	At least 40 mm		Fill level detection

Release date: 2023-07-21 Date of issue: 2023-07-21 Filename: 803585\_eng.pdf