



Background suppression sensor ML17-8-H-50-RT/115/136



- Compact, versatile housing
- 360° high visibility LEDs
- Very low color sensitivity
- Front mounting with M18-threads or side mounting holes
- Sturdy, waterproof plastic housing
- Tamper-proof version with no adjustments

Background suppression sensor



Dimensions

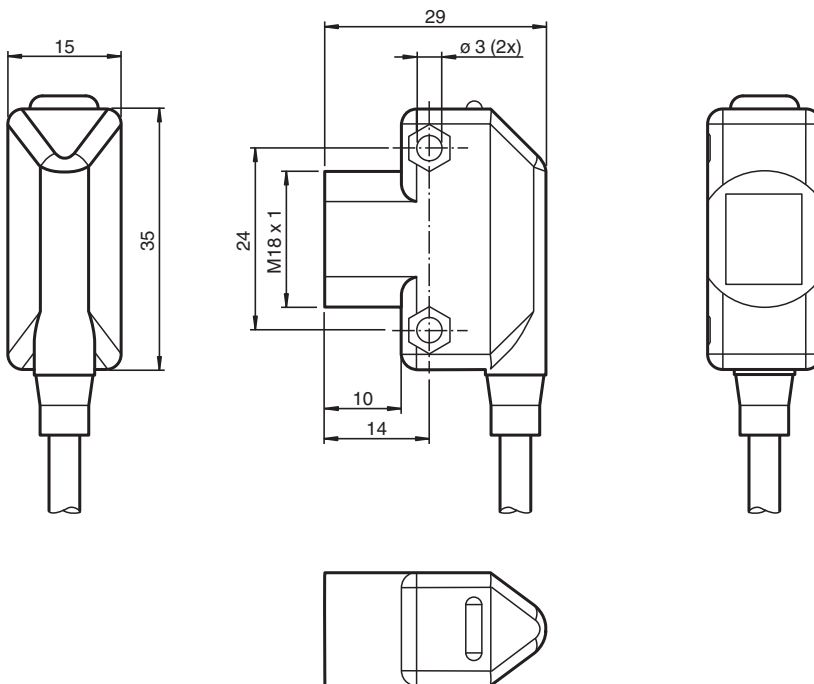

Technical Data

General specifications

Detection range	10 ... 50 mm
Background suppression	starts from 65 mm
Reference target	standard black, 100 mm x 100 mm
Light source	LED
Light type	modulated visible red light , 640 nm
Black-white difference (6 %/90 %)	≤ 10 %
Diameter of the light spot	≤ 3 mm at 50 mm
Opening angle	≤ 4 °
Ambient light limit	≤ 40000 Lux

Indicators/operating means

Operation indicator	green LED , solid : Power on green LED , flashing: Short circuit/overload indication
---------------------	---

Release date: 2022-03-30 Date of issue: 2022-03-30 Filename: 905786_eng.pdf

Refer to "General Notes Relating to Pepperl+Fuchs Product Information".

Pepperl+Fuchs Group
www.pepperl-fuchs.com

USA: +1 330 486 0001
fa-info@us.pepperl-fuchs.com

Germany: +49 621 776 1111
fa-info@de.pepperl-fuchs.com

Singapore: +65 6779 9091
fa-info@sg.pepperl-fuchs.com

PF PEPPERL+FUCHS

Technical Data

Function indicator		LED yellow, lights up with receiver lit
Electrical specifications		
Operating voltage	U_B	10 ... 30 V DC , class 2
Ripple		max. 10 %
No-load supply current	I_0	< 30 mA
Time delay before availability	t_v	≤ 100 ms
Output		
Switching type		light/dark on
Signal output		2 push-pull (4 in 1) outputs, short-circuit protected, reverse polarity protected, overvoltage protected
Switching voltage		max. 30 V DC
Switching current		max. 100 mA
Voltage drop	U_d	≤ 2.5 V DC
Switching frequency	f	500 Hz
Response time		≤ 1 ms
Conformity		
Product standard		EN 60947-5-2
Approvals and certificates		
EAC conformity		TR CU 020/2011
UL approval		cULus
CCC approval		CCC approval / marking not required for products rated ≤36 V
Ambient conditions		
Ambient temperature		-20 ... 55 °C (-4 ... 131 °F)
Storage temperature		-20 ... 70 °C (-4 ... 158 °F)
Mechanical specifications		
Housing width		15 mm
Housing height		34.5 mm
Degree of protection		IP67
Connection		2 m PVC cable
Material		
Housing		ABS
Optical face		Acrylic
Mass		approx. 40 g

Connection Assignment

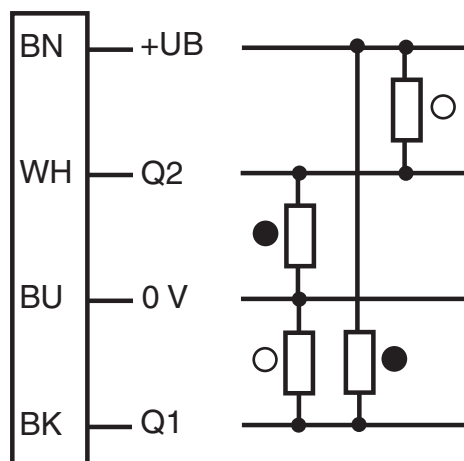

○ = Light on
● = Dark on

Release date: 2022-03-30 Date of issue: 2022-03-30 Filename: 905786_eng.pdf

Refer to "General Notes Relating to Pepperl+Fuchs Product Information".

Pepperl+Fuchs Group
www.pepperl-fuchs.com

USA: +1 330 486 0001
fa-info@us.pepperl-fuchs.com

Germany: +49 621 776 1111
fa-info@de.pepperl-fuchs.com

Singapore: +65 6779 9091
fa-info@sg.pepperl-fuchs.com

PF PEPPERL+FUCHS

Indication

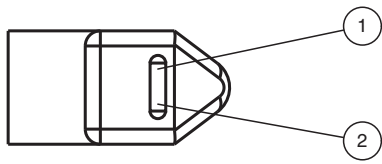

1	Signal display	yellow
2	Operating display	green

Characteristic Curve

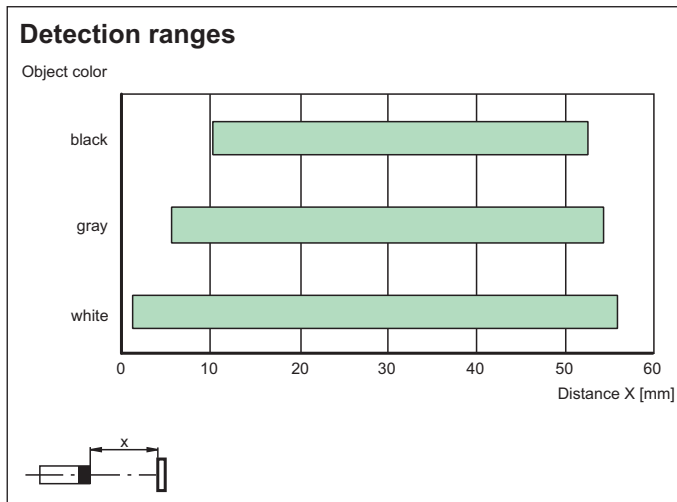
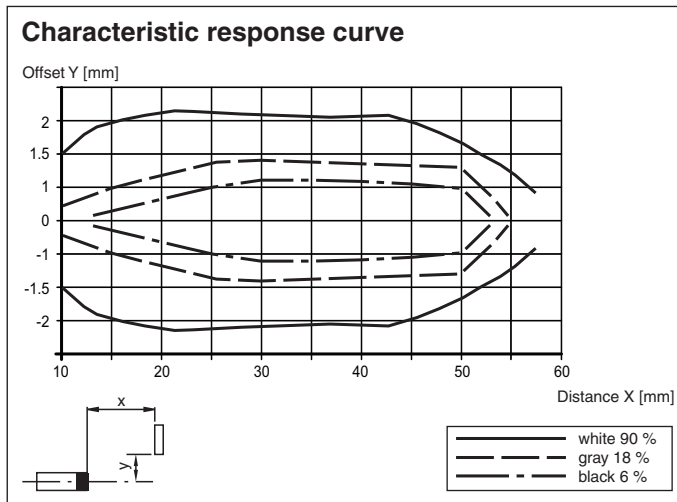

Accessories

	OMH-ML17	Mounting bracket
	OMH-ML17-1	Mounting bracket

Release date: 2022-03-30 Date of issue: 2022-03-30 Filename: 905786_eng.pdf