

# Inductive sensor

## NJ2-D-US-1.750-V93



- 2-wire AC/DC
- Weld Immune
- Sensing range 2 mm
- 3000 psi rating

### Cylinder Position Switch



## Dimensions

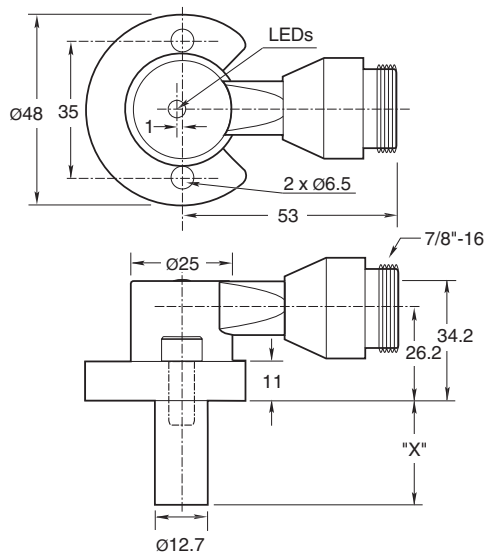

## Technical Data

General specifications		
Switching function		Normally open (NO)
Output type		Two-wire
Rated operating distance	$s_n$	2 mm
Installation		flush
Output polarity		AC/DC
Assured operating distance	$s_a$	0 ... 1.62 mm
Reduction factor $r_{Al}$		0.4
Reduction factor $r_{304}$		0.85
Output type		2-wire
Nominal ratings		
Switching frequency	$f$	0 ... 20 Hz
Hysteresis	$H$	10 ... 20 % 15 typ.

Release date: 2023-10-18 Date of issue: 2023-10-18 Filename: 906595\_eng.pdf

Refer to "General Notes Relating to Pepperl+Fuchs Product Information".

Pepperl+Fuchs Group  
www.pepperl-fuchs.com

USA: +1 330 486 0001  
fa-info@us.pepperl-fuchs.com

Germany: +49 621 776 1111  
fa-info@de.pepperl-fuchs.com

Singapore: +65 6779 9091  
fa-info@sg.pepperl-fuchs.com

PEPPERL+FUCHS

## Technical Data

Reverse polarity protection		yes
Short-circuit protection		yes
Voltage drop	$U_d$	$\leq 7\text{ V}$
Momentary current (20 ms, 0.1 Hz)		max. 3 A
Rated operating current	$I_e$	8 ... 300 mA AC/DC
Off-state current	$I_r$	$\leq 1.7\text{ mA}$
Mag. Field strength, AC fields		250 mT
Mag. Field strength, DC fields		100 mT
<b>Limit data</b>		
Operating pressure dynamically		3000 psi
<b>Indicators/operating means</b>		
LED green		Power on
LED red		Output status
LED red/green		Short circuit/overload indication
<b>Electrical specifications</b>		
Rated operating voltage	$U_e$	20 ... 250 V AC/DC
<b>Standard conformity</b>		
Standards		EN 60947-5-2
<b>Approvals and certificates</b>		
UL approval		cULus Listed, General Purpose
<b>Ambient conditions</b>		
Ambient temperature		-25 ... 70 °C (-13 ... 158 °F)
<b>Mechanical specifications</b>		
Connection type		Connector plug 7/8 inch-16 UN , 3-pin
Degree of protection		IP67
Material		Housing: zinc Probe: aluminum
Note		X = 1.750 in (44.5 mm)

## Connection

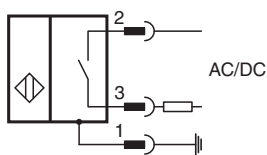

## Connection Assignment

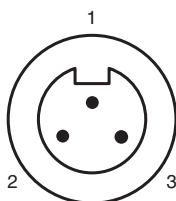

Release date: 2023-10-18 Date of issue: 2023-10-18 Filename: 906595\_eng.pdf

## Connection Assignment

Wire colors

1	GN	(green)
2	BK	(black)
3	WH	(white)

## Additional Information

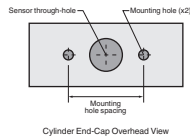

**NPT Type Mounting Holes:**  
 1000 and 3000 psi NPT Types:  
 Mounting hole screw thread shall be 1/4" - 20.  
 Minimum thread engagement depth is 0.250" (6.35 mm)  
 Hole spacing is 35 mm center to center.



**Mounting Screws:**  
 Standard 1000 and 3000 psi models use two, self-locking 1/4"- 20 socket head cap screws (provided).  
 Recommended tightening torque: 150 in lb (16.95 N-m).

**⚠ Important:** When using spacers, make certain to maintain the 0.250" (6.35 mm) minimum mounting screw thread engagement.

## Accessories

	<b>SPACER 0.160 TO 0.375</b> : Spacer for cylinder switches X.XXX"
	<b>SPACER 0.380 TO 0.875</b> : Spacer for cylinder switches X.XXX"
	<b>SPACER 0.880 TO 1.750</b> : Spacer for cylinder switches X.XXX"

Release date: 2023-10-18 Date of issue: 2023-10-18 Filename: 906595\_eng.pdf