



Diffuse mode sensor RL61-8-1000-Z/92/136



- Cost-optimized series for standard tasks in a special design
- Compact design
- Wide range of mounting options thanks to cubic housing design with M30 thread
- 360° high visibility LEDs
- Programmable ON-delay, OFF-delay, and One-shot timers
- 4-in-1 output (push-pull)

Diffuse mode sensor



Function

The Series 61 sensor family is a comprehensive product line, offering five sensing modes. Each sensor is equipped with four LEDs that are highly visible from all directions, indicating Power-On, target presence and marginal excess gain. The widely recognized, polycarbonate housing provides a IP67 protection degree rating. Color-coded labels are clearly printed on the housing to easily identify the sensing mode. DC models offer a 4-in-1 output while AC/DC models have a SPDT relay output rated to 3 A. All versions come standard with an integral multifunction timer, sensitivity adjustment and Light-ON/Dark-ON switch. Series 61 sensors are cross-talk protected and have a high degree of resistance to ambient lighting. Each sensor can be mounted via front and rear slots, rear dovetail guide or M30 x 1.5 mounting base. Additionally, cabled sensor models provide ½" - 14 NPT internal threads for use with flexible conduit.

Application

- Object tracking in material handling, and the packaging sector
- Material flow monitoring
- Bin occupancy check in storage technology
- Fine positioning in high-bay warehouses
- Presence and height monitoring on pallet conveyors
- Single-beam protection for automatic industrial gates and elevator doors
- Protection at automatic gates

Dimensions

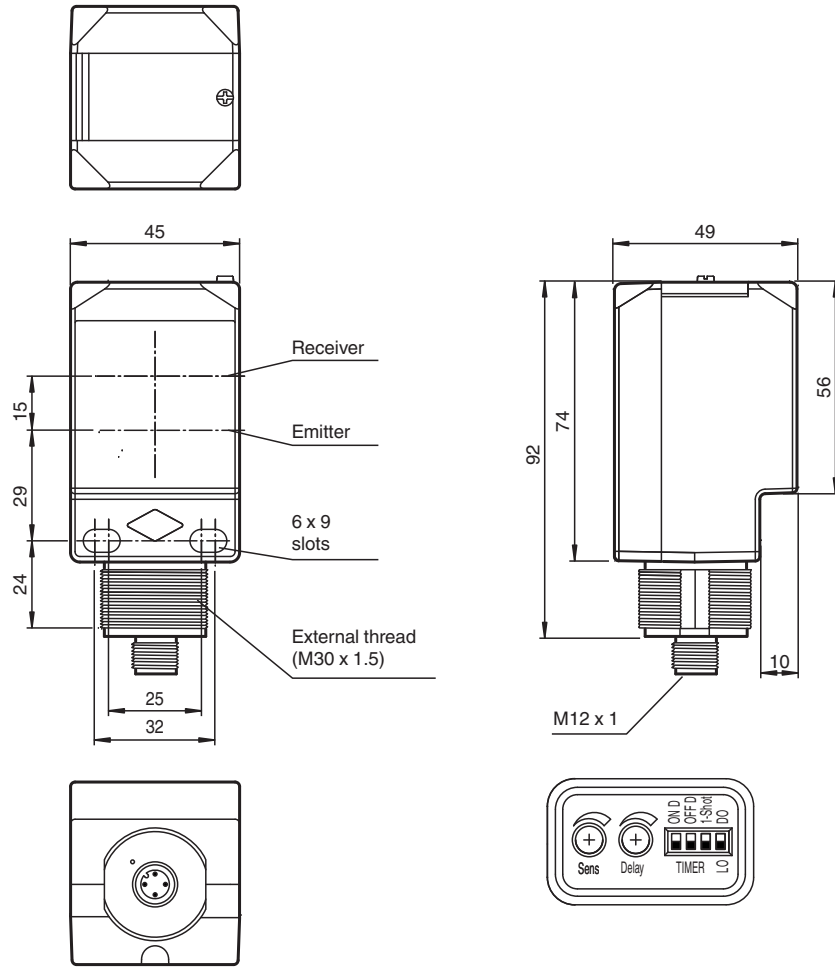

Technical Data

General specifications

Detection range	0 ... 1000 mm adjustable
Adjustment range	120 ... 1000 mm
Reference target	standard white 200 mm x 200 mm
Light source	IRED
Light type	modulated infrared light , 850 nm
Diameter of the light spot	approx. 17 mm at a distance of 1000 mm
Opening angle	1 °
Ambient light limit	5000 Lux ; according EN 60947-5-2

Indicators/operating means

Operation indicator	2 LEDs green
Function indicator	2 LEDs yellow ON: object inside the sensing range OFF: object outside the sensing range
Control elements	Light-on/dark-on changeover switch
Control elements	Sensing range adjuster
Control elements	Time adjuster (0 ... 50 ms)

Electrical specifications

Operating voltage	U_B	10 ... 30 V DC
Ripple		10 %
No-load supply current	I_0	≤ 35 mA
Protection class		II , rated voltage ≤ 250 V AC with pollution degree 1-2 according to IEC 60664-1 Output circuit basis insulation of input circuit according to EN 50178, rated insulation voltage 240 V AC

Release date: 2022-08-08 Date of issue: 2022-08-08 Filename: 9111612_eng.pdf

Refer to "General Notes Relating to Pepperl+Fuchs Product Information".

Technical Data

Output		
Switching type		light/dark on, switchable
Signal output		2 push-pull (4 in 1) outputs, short-circuit protected, reverse polarity protected
Switching voltage		max. 30 V DC
Switching current		max. 100 mA
Voltage drop	U_d	≤ 2.5 V
Switching frequency	f	500 Hz
Response time		≤ 1 ms
Timer function		DIP switch for selection of operating modes
Compliance with standards and directives		
Standard conformity		
Product standard		EN 60947-5-2:2007 IEC 60947-5-2:2007
Approvals and certificates		
EAC conformity		TR CU 020/2011
UL approval		cULus
CCC approval		CCC approval / marking not required for products rated ≤ 36 V
Ambient conditions		
Ambient temperature		-40 ... 55 °C (-40 ... 131 °F)
Storage temperature		-40 ... 70 °C (-40 ... 158 °F)
Mechanical specifications		
Housing width		45 mm
Housing height		73.7 mm
Housing depth		48.6 mm
Degree of protection		IP67
Connection		4-pin, M12 x 1 connector
Material		
Housing		PC (Polycarbonate)
Optical face		PMMA
Mass		120 g
Tightening torque, fastening screws		max. 2 Nm

Connection Assignment

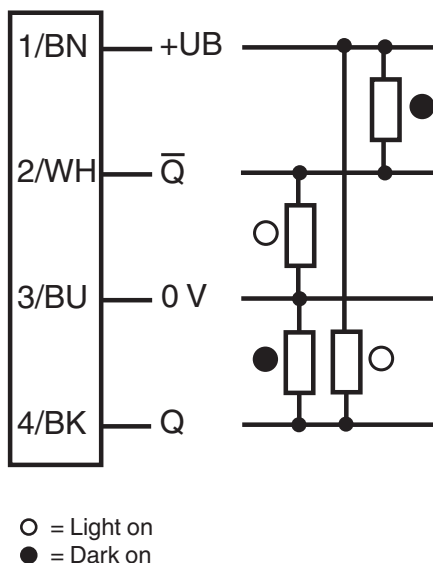

Release date: 2022-08-08 Date of issue: 2022-08-08 Filename: 9111612_eng.pdf

Refer to "General Notes Relating to Pepperl+Fuchs Product Information".

Pepperl+Fuchs Group
www.pepperl-fuchs.com

USA: +1 330 486 0001
fa-info@us.pepperl-fuchs.com

Germany: +49 621 776 1111
fa-info@de.pepperl-fuchs.com

Singapore: +65 6779 9091
fa-info@sg.pepperl-fuchs.com

PF PEPPERL+FUCHS

Connection Assignment

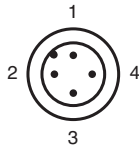

Wire colors in accordance with EN 60947-5-2

1	BN	(brown)
2	WH	(white)
3	BU	(blue)
4	BK	(black)

Assembly

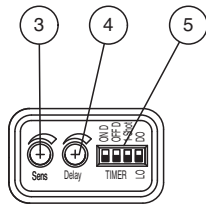
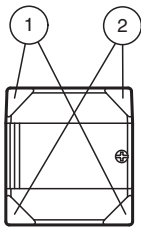

1	Operating display	green
2	Signal display	yellow
3	Sensing range adjuster	
4	Time adjuster	
5	DIP-switches	

Characteristic Curve

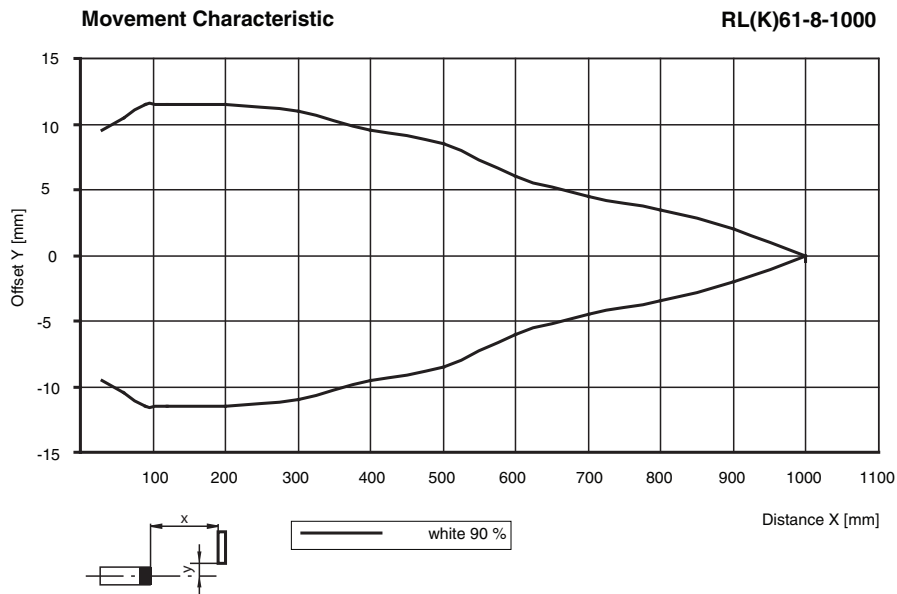

Release date: 2022-08-08 Date of issue: 2022-08-08 Filename: 9111612_eng.pdf

Characteristic Curve

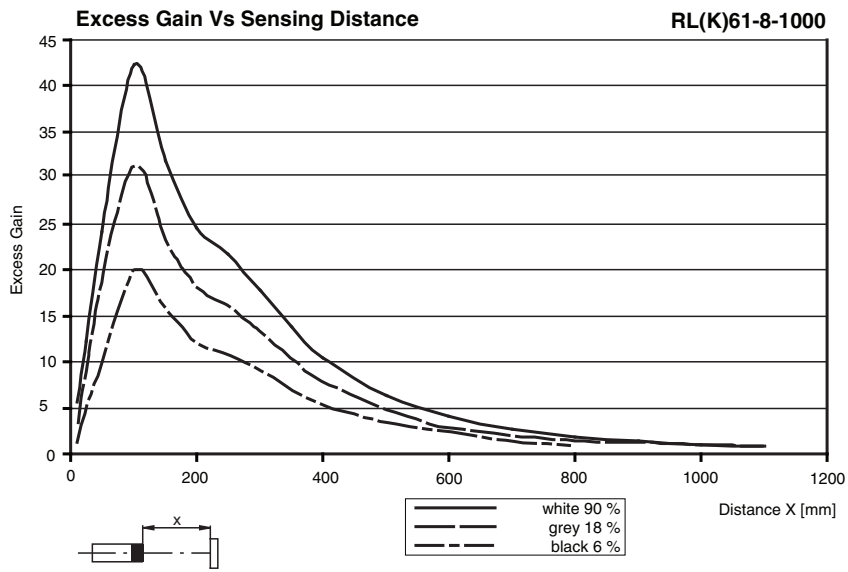

Release date: 2022-08-08 Date of issue: 2022-08-08 Filename: 911612_eng.pdf

Refer to "General Notes Relating to Pepperl+Fuchs Product Information".







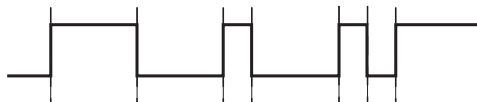
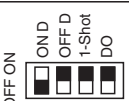
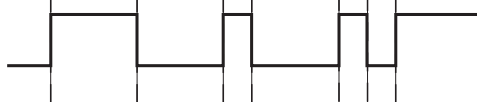

Pepperl+Fuchs Group
 www.pepperl-fuchs.com

USA: +1 330 486 0001
 fa-info@us.pepperl-fuchs.com

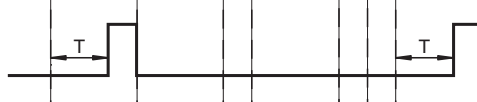
Germany: +49 621 776 1111
 fa-info@de.pepperl-fuchs.com

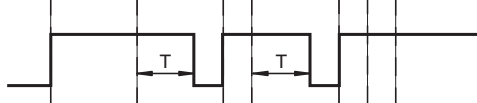
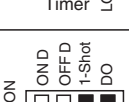
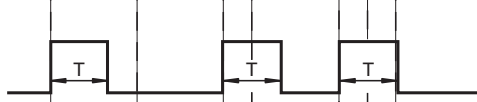
Singapore: +65 6779 9091
 fa-info@sg.pepperl-fuchs.com

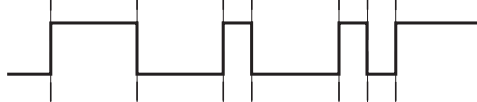
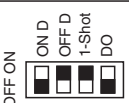
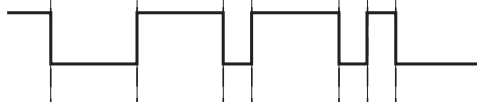
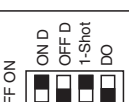
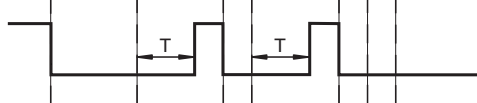

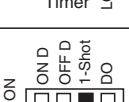
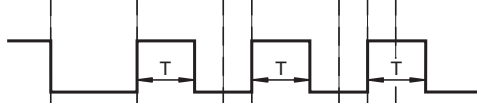

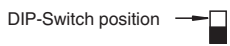

Timer Functions

Switching Type	Detection Status	Operation Mode	Light Received	No Light Received
L.ON				
OFF ON  Timer LO	No Delay (Timer OFF)		ON	OFF
OFF ON  Timer LO	ON Delay		ON	OFF
OFF ON  Timer LO	OFF Delay		ON	OFF
OFF ON  Timer LO	One-Shot Delay		ON	OFF
OFF ON  Timer LO	ON Delay and OFF Delay		ON	OFF
D.ON				
OFF ON  Timer LO	No Delay (Timer OFF)		ON	OFF
OFF ON  Timer LO	ON Delay		ON	OFF
OFF ON  Timer LO	OFF Delay		ON	OFF
OFF ON  Timer LO	One-Shot Delay		ON	OFF
OFF ON  Timer LO	ON Delay and OFF Delay		ON	OFF



Release date: 2022-08-08 Date of issue: 2022-08-08 Filename: 911612_eng.pdf

Accessories

	MPZB01	Mounting bracket with vertical slots
	MPZB02	Mounting bracket with circular slots
	MPZB06	Ball and Swivel Mounting Bracket
	MPZB07	Ball and Swivel Vertical Mounting Plate
	V1-G-2M-PUR	Female cordset single-ended M12 straight A-coded, 4-pin, PUR cable grey
	V1-W-2M-PUR	Female cordset single-ended M12 angled A-coded, 4-pin, PUR cable grey

Timer Functions

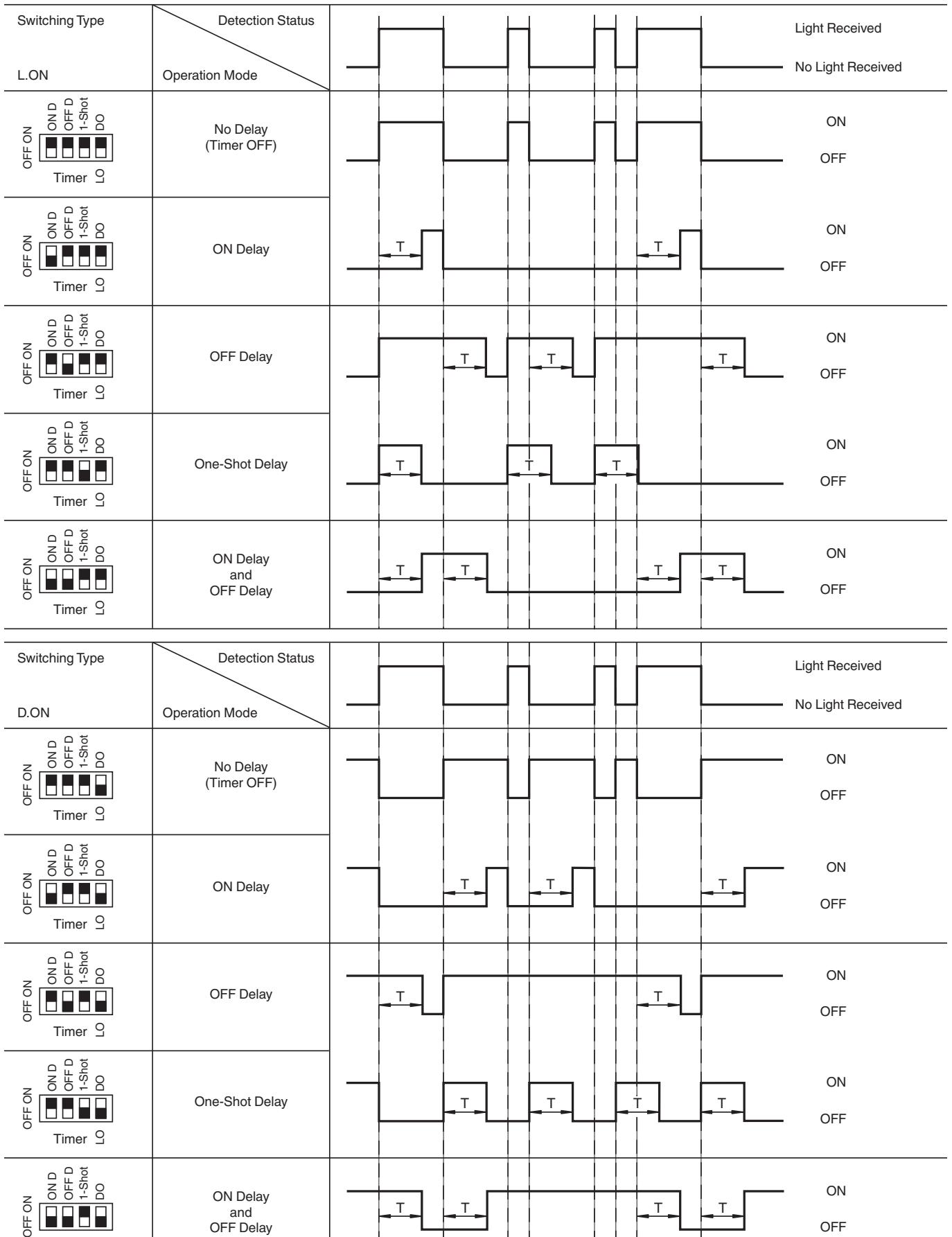

Release date: 2022-08-08 Date of issue: 2022-08-08 Filename: 9111612_eng.pdf

Refer to "General Notes Relating to Pepperl+Fuchs Product Information".

Pepperl+Fuchs Group
www.pepperl-fuchs.com

USA: +1 330 486 0001
fa-info@us.pepperl-fuchs.com

Germany: +49 621 776 1111
fa-info@de.pepperl-fuchs.com

Singapore: +65 6779 9091
fa-info@sg.pepperl-fuchs.com

PEPPERL+FUCHS

Time (T) is adjustable from 0 to 50 ms

Adjustment Instructions

Intended use:

The diffuse mode sensor contains the emitter and receiver in a single housing. The light from transmitter is reflected back from the target object and is evaluated by the receiver. The sensing range depends on the object color and finish. With dark or very small objects, the sensing range is reduced.

Mounting instructions:

The sensor can be mounted using the through-holes or with a mounting bracket (not included with delivery).

The base surface must be flat to avoid distorting the sensor housing during mounting. It is advisable to secure the bolts and screws with washers so that the sensor does not become misaligned.

Adjustment Instructions:

Adjust the sensor on the background. If the yellow LED illuminates, reduce the sensing range using the potentiometer until the yellow LED turns off.

Object detection:

Move the target into the light beam. Position the light spot on the object. If the object is detected, the yellow LED lights up. If it does not light up, further adjust the sensing range with the potentiometer until the yellow LED lights up.

Cleaning:

We recommend that you clean the optical interfaces and check all connections at regular intervals.