

## Active infrared scanner

### AIR30-8-H-2500/38a

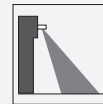

- Single-beam light scanner
- Can be used to monitor both main and ancillary closing edges
- Closing edge safety on revolving doors and carousel doors
- Accurate beam alignment thanks to finely bundled light beam
- Background suppression operating mode: ignores objects outside the sensing range

Single-beam active infrared scanner, background suppression, max. installation height 2.5 m, black housing, relay contact output, fixed cable



#### Function

AIR30 is a series of active infrared scanners with excellent optical properties for monitoring closing edges in a wide range of door systems. The diverse range of housings and mounting options allow the devices to be adapted to suit a whole host of mounting conditions.

#### Application

- Monitoring closing edges and crushing points on revolving doors and carousel doors
- Door monitoring system in local public transportation

## Dimensions

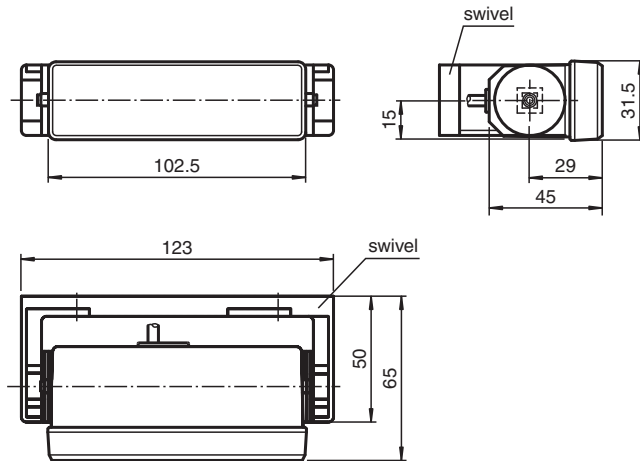

Mounting dimensions for swivel

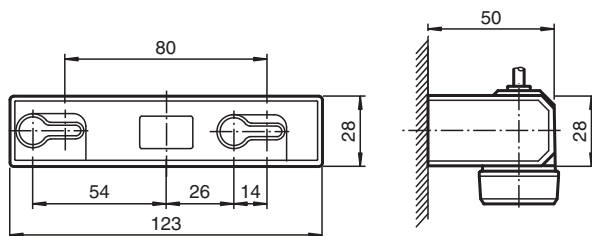

Mounting dimensions with mounting bracket set AIR30

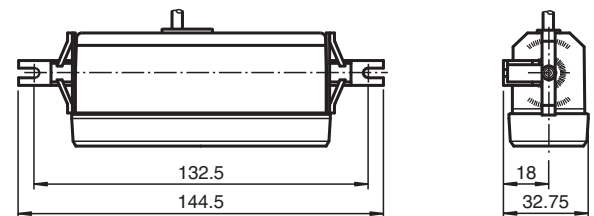

## Technical Data

### General specifications

Detection range min.	550 ... 1000 mm
Detection range max.	550 ... 2500 mm
Light source	IRED
Light type	modulated infrared light
Black-white difference (6%/90%)	≤ 400 mm at a distance of 2000 mm
Transmitter frequency	1800 Hz
Operating mode	Background suppression
Diameter of the light spot	50 mm at 2000 mm sensor range
Opening angle	approx. 1.4 °
Accessories provided	Swivel bracket, Mounting bracket

### Functional safety related parameters

MTTF <sub>d</sub>	1050 a
Mission Time (T <sub>M</sub> )	20 a
Diagnostic Coverage (DC)	90 %

### Indicators/operating means

Function indicator	LED red: lights up when output is active
Control elements	Sensing range adjuster, light-on/dark-on changeover switch

### Electrical specifications

Operating voltage	U <sub>B</sub>	10 ... 48 V DC / 11 ... 36 V AC
No-load supply current	I <sub>0</sub>	100 mA

### Input

Release date: 2023-04-04 Date of issue: 2023-04-04 Filename: 119899\_eng.pdf

Refer to "General Notes Relating to Pepperl+Fuchs Product Information".

## Technical Data

Test input		emitter deactivation at +U <sub>B</sub>
<b>Output</b>		
Switching type		light/dark on, switchable
Signal output		relay, 1 NO
Switching voltage		≤ 50 V AC / 24 V DC
Switching current		≤ 200 mA AC / 1 A DC
Response time		70 ms
De-energized delay	t <sub>off</sub>	approx. 200 ms
<b>Standard conformity</b>		
Standards		EN 60947-5-2
Standards 2		EN 61000-6-2 without EN 61000-4-5, EN 61000-4-11
Standards 3		EN 61000-6-3
<b>Approvals and certificates</b>		
CCC approval		Certified by China Compulsory Certification (CCC)
<b>Ambient conditions</b>		
Ambient temperature		-20 ... 60 °C (-4 ... 140 °F)
Storage temperature		-20 ... 75 °C (-4 ... 167 °F)
<b>Mechanical specifications</b>		
Degree of protection		IP52
Connection		5 m fixed cable
Material		
Housing		plastic
Optical face		Luran®
Mass		50 g

## Connection Assignment

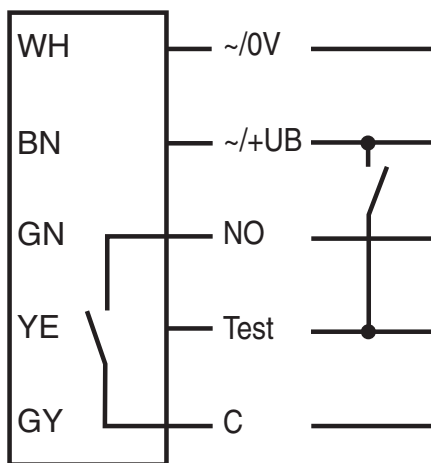

### Note:

Test input can not be used, if sensor is supplied with AC voltage!

## Assembly

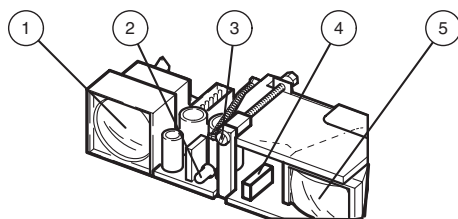

1	Transmitter
2	Indication-LED
3	Detection range adjuster
4	Light / Dark switch
5	Receiver

**Characteristic Curve**

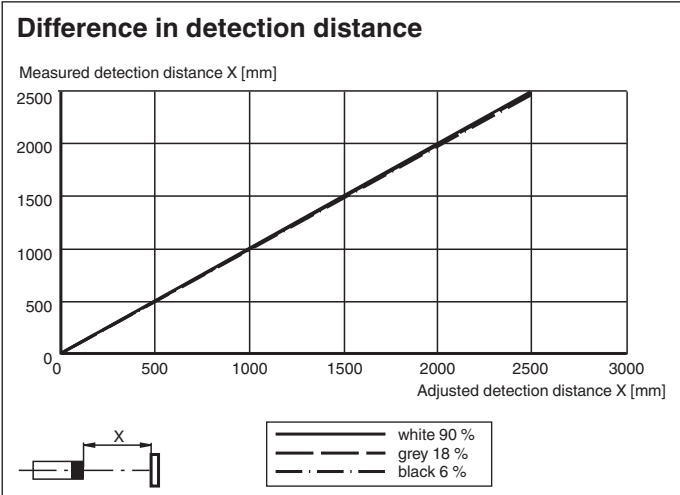
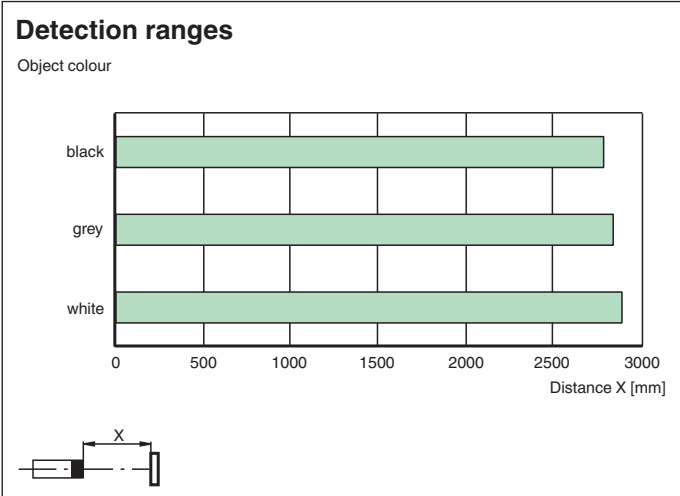
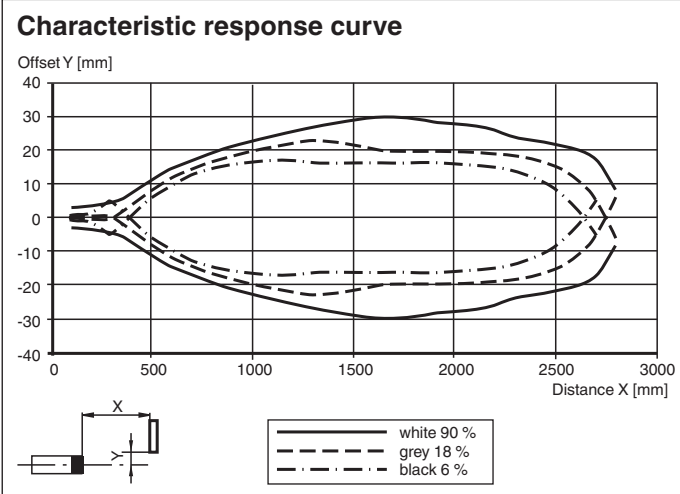

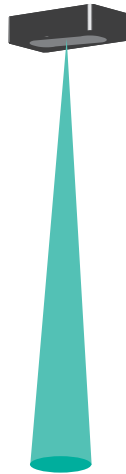

Release date: 2023-04-04 Date of issue: 2023-04-04 Filename: 119899\_eng.pdf

## Application



## Accessories

	<b>UP-Einbaurahmen</b>	Mounting frame for sensors in the AIR30 and PROSCAN series
	<b>Flush Mounting AIR30</b>	Installation cover for AIR30 series sensors
	<b>Wetterhaube AIR30</b>	Weather hood for series AIR30

## Function Principle

Active infrared scanners detect people and objects using short-wave infrared radiation according to the triangulation principle. A switch signal is tripped if the infrared beam emitted is reflected by an object within the specified sensing range. Where background suppression is activated, the background (e.g. ground) is detected but not evaluated. This allows an extremely precise detection area to be set and ensures reliable detection of people, vehicles and other objects.

**Function principle background suppression**

