



## Retroreflective sensor RLK31-54/25/31/115 SET



- Photoelectric sensor for detecting people, objects and vehicles
- Large construction with small housing
- Not sensitive to ambient light
- Version for universal voltages
- Relay output
- Version with accessories in scope of delivery

Mid-range photoelectric sensors for detecting people, objects, and vehicles



### Function

Series 31 is a range of cost-effective and, most importantly, reliable photoelectric sensors for standard applications in the fields of material handling and logistics, and for monitoring industrial doors, elevators, and automatic gates. The ultrasonic-welded plastic housing provides a high degree of protection, making these sensors ideal for tasks in harsh outdoor conditions. These sensors are currently the most compact "wide range power supply sensors" that can work with any DC and AC voltage between 24 V and 240 V. In addition to the robust technology, the sensors offer numerous product details that help the user with assembly, connection and operation.

### Application

- Monitoring closing edges of automatic industrial doors and elevators
- Monitoring the swing range of automatic gates
- Detecting and tracking objects in material handling

**Dimensions**

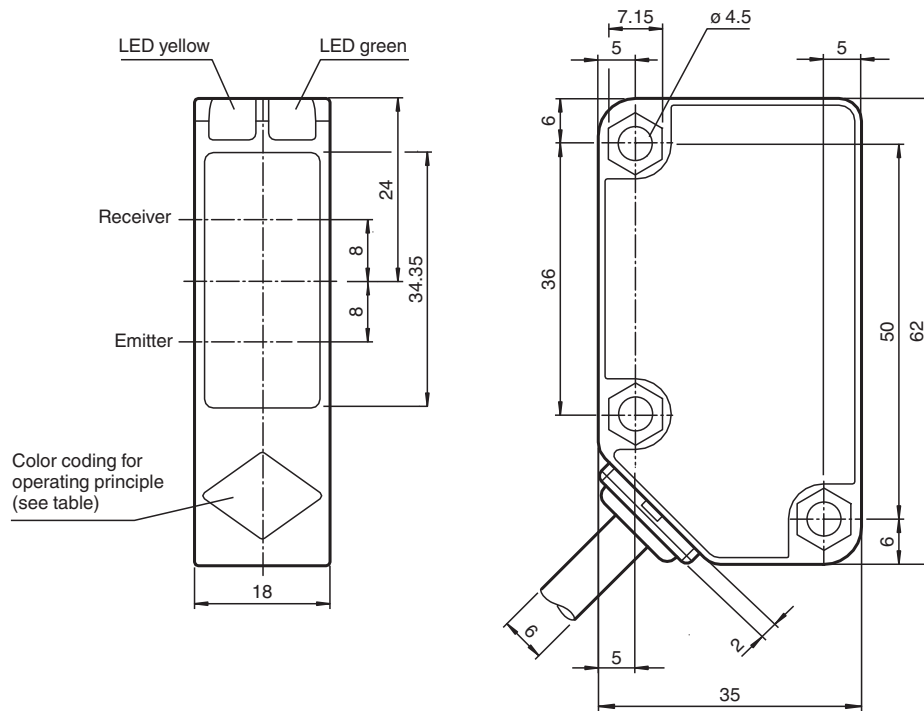

Operating principle	color
Retroreflective sensor with polarisation filter	green
Retroreflective sensor	blue
Diffusive mode sensor	white
Thru -beam sensor	grey
Diffusive mode sensor with background suppression	red

**Technical Data**

General specifications	
Effective detection range	0 ... 9000 mm
Reflector distance	20 ... 9000 mm
Threshold detection range	12 m
Reference target	reflector C110-2
Light source	LED
Light type	modulated visible red light , 630 nm
Diameter of the light spot	approx. 200 mm at a distance of 6 m
Opening angle	3 °
Ambient light limit	50000 Lux
Accessories provided	reflector C110-2 OMH-RL31-01 mounting bracket with mounting materials
Functional safety related parameters	
MTTF <sub>d</sub>	790 a
Mission Time (T <sub>M</sub> )	20 a
Diagnostic Coverage (DC)	0 %
Indicators/operating means	
Operation indicator	LED green: power on
Function indicator	LED yellow: 1. LED lit constantly: signal > 2 x switching point (function reserve) 2. LED flashes: signal between 1 x switching point and 2 x switching point 3. LED off: signal < switching point
Electrical specifications	

Release date: 2022-08-03 Date of issue: 2022-08-03 Filename: 189745\_eng.pdf

Refer to "General Notes Relating to Pepperl+Fuchs Product Information".

## Technical Data

Operating voltage	$U_B$	24 ... 240 V AC 12 ... 240 V DC
No-load supply current	$I_0$	≤ 40 mA
Power consumption	$P_0$	≤ 2 VA
<b>Output</b>		
Switching type		light-on
Signal output		Relay, 1 alternator
Switching voltage		max. 240 V AC
Switching current		max. 3 A
Switching power		DC: max. 150 W AC: max. 750 VA
Switching frequency	$f$	20 Hz
Response time		≤ 25 ms
<b>Conformity</b>		
Product standard		EN 60947-5-2
<b>Approvals and certificates</b>		
EAC conformity		TR CU 020/2011 TR CU 004/2011
Protection class		II, rated voltage ≤ 250 V AC with pollution degree 1-2 according to IEC 60664-1 Output circuit basis insulation of input circuit according to EN 50178, rated insulation voltage 240 V AC
CCC approval		Certified by China Compulsory Certification (CCC)
<b>Ambient conditions</b>		
Ambient temperature		-25 ... 55 °C (-13 ... 131 °F)
Storage temperature		-40 ... 70 °C (-40 ... 158 °F)
<b>Mechanical specifications</b>		
Degree of protection		IP67
Connection		2 m fixed cable
Material		
Housing		Polycarbonate
Optical face		PMMA
Mass		154 g

## Connection Assignment

Option:

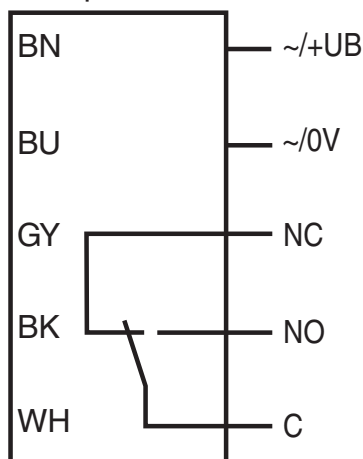

Release date: 2022-08-03 Date of issue: 2022-08-03 Filename: 189745\_eng.pdf

Refer to "General Notes Relating to Pepperl+Fuchs Product Information".

Pepperl+Fuchs Group  
www.pepperl-fuchs.com

USA: +1 330 486 0001  
fa-info@us.pepperl-fuchs.com

Germany: +49 621 776 1111  
fa-info@de.pepperl-fuchs.com

Singapore: +65 6779 9091  
fa-info@sg.pepperl-fuchs.com

 PEPPERL+FUCHS

**Assembly**

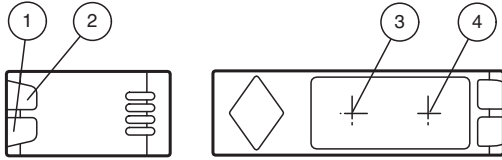

1	Operating display	green
2	Signal display	yellow
3	Emitter	
4	Receiver	

**Characteristic Curve**

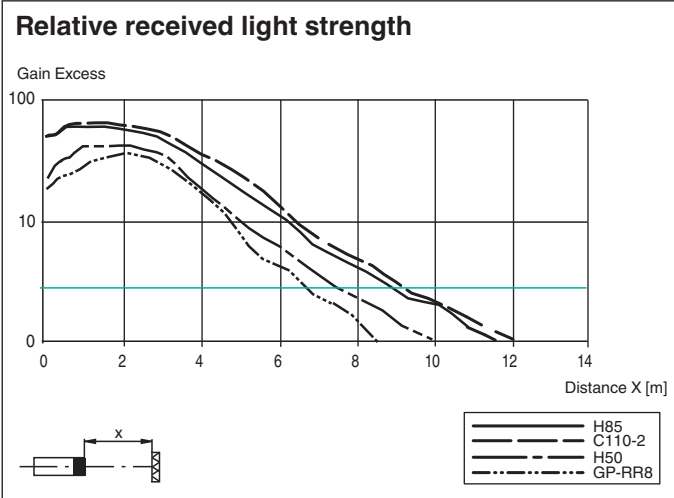
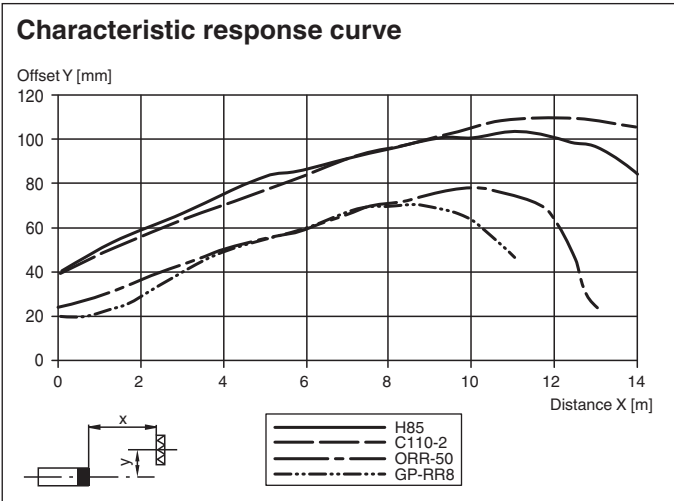





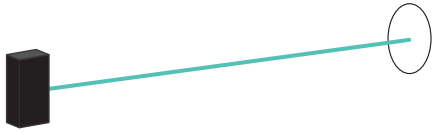



Release date: 2022-08-03 Date of issue: 2022-08-03 Filename: 189745\_eng.pdf

## Application



## Accessories

	<b>REF-H50</b>	Reflector, rectangular 51 mm x 61 mm, mounting holes, fixing strap
	<b>REF-H60-2</b>	Reflector with mounting holes
	<b>REF-H85-2</b>	Reflector, rectangular 84.5 mm x 84.5 mm, mounting holes
	<b>REF-H160</b>	Reflector, rectangular 60 mm x 18 mm, mounting holes
	<b>REF-H180</b>	Reflector, rectangular 182 mm x 42 mm, mounting holes
	<b>REF-C110-2</b>	Reflector, round $\varnothing$ 84 mm, central mounting hole
	<b>OFR-100/100</b>	Reflective tape 100 mm x 100 mm
	<b>Weather Cap for REF-C110-2</b>	Weather hood for series reflector