

Active infrared scanner

TOPSCAN2-8-HS-2500-3/L1350/38a

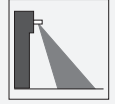

- Moving presence sensor for swing doors
- Configurable for a wide range of door leaf widths
- Each beam can be adjusted individually
- Selectable background suppression and evaluation
- Beam adjustment to closing edge width
- Test input
- Three-beam version

Single or multi-beam light curtain for individual protection



Function

The TopScan2 series is a modular sensor system that can be used in a flexible manner for various requirements relating to the monitoring of automatic doors. The system can be mounted for either static or mobile use. The housing can be easily shortened and up to five sensor modules can be arranged side by side, whereby each beam can be configured individually. When it comes to the operating modes, there is the choice between background suppression and background evaluation. The light or dark switching modes, detection range and closing edge alignment can also be adjusted. These features make the TopScan2 active infrared scanner ideal for use with a wide range of automatic door systems.

Dimensions

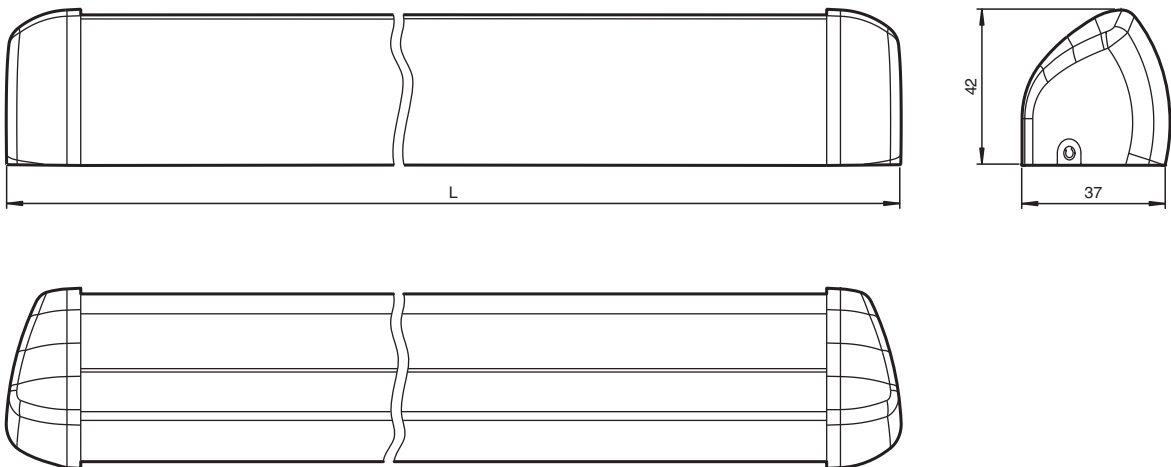

Technical Data

General specifications

Detection range min.	0 ... 1500 mm by background evaluation, 500 ... 1500 mm by background suppression
Detection range max.	0 ... 2500 mm with background evaluation, 500 ... 2500 mm with background suppression
Light source	IRED
Black-white difference (6%/90%)	< 20 % at 2000 mm sensor range
Marking	CE
Number of beams	3 (number of built-in sensor modules AIR)
Operating mode	switching between background suppression/evaluation
Diameter of the light spot	75 x 75 mm by sensing range 2000 mm

Indicators/operating means

Release date: 2024-07-19 Date of issue: 2024-07-19 Filename: 418042_eng.pdf

Refer to "General Notes Relating to Pepperl+Fuchs Product Information".

Pepperl+Fuchs Group
www.pepperl-fuchs.com

USA: +1 330 486 0001
fa-info@us.pepperl-fuchs.com

Germany: +49 621 776 1111
fa-info@de.pepperl-fuchs.com

Singapore: +65 6779 9091
fa-info@sg.pepperl-fuchs.com

PEPPERL+FUCHS

Technical Data

Function indicator		LED red
Control elements		Sensing range adjuster, light-on/dark-on changeover switch, changeover switch for mode of operation Background suppression / Background evaluation ; Adjuster for edge monitoring left/right
Factory setting		Background suppression
Electrical specifications		
Operating voltage	U_B	17 ... 30 V DC , 18 ... 28 V AC
No-load supply current	I_0	< 100 mA
Input		
Test input		emitter deactivation with $U = 17 \dots 30$ V DC only in background evaluation mode of operation and DC operation
Output		
Switching type		Light-on/dark-on changeover switch
Signal output		Relay, 1 alternator
Switching voltage		max. 24 V DC , 48 V AC
Switching current		≤ 1 A
Switching power		24 W / 55 VA
Response time		30 ms , 2 s after test
Compliance with standards and directives		
Standard conformity		
Standards		EN 61000-6-2, EN 61000-6-3
Approvals and certificates		
CCC approval		CCC approval / marking not required for products rated ≤ 36 V
UN/ECE Regulation No. 10 (E1)		Type-approval number: 047349
Ambient conditions		
Ambient temperature		-20 ... 60 °C (-4 ... 140 °F)
Mechanical specifications		
Housing length L		1350 mm
Mounting height		max. 2500
Degree of protection		IP52
Connection		screw terminals
Material		
Housing		aluminum / ABS
Optical face		PC
Mass		approx. 650 g
Dimensions		
Height		42 mm
Depth		37 mm
Length		1350 mm

Release date: 2024-07-19 Date of issue: 2024-07-19 Filename: 418042_eng.pdf

Connection Assignment

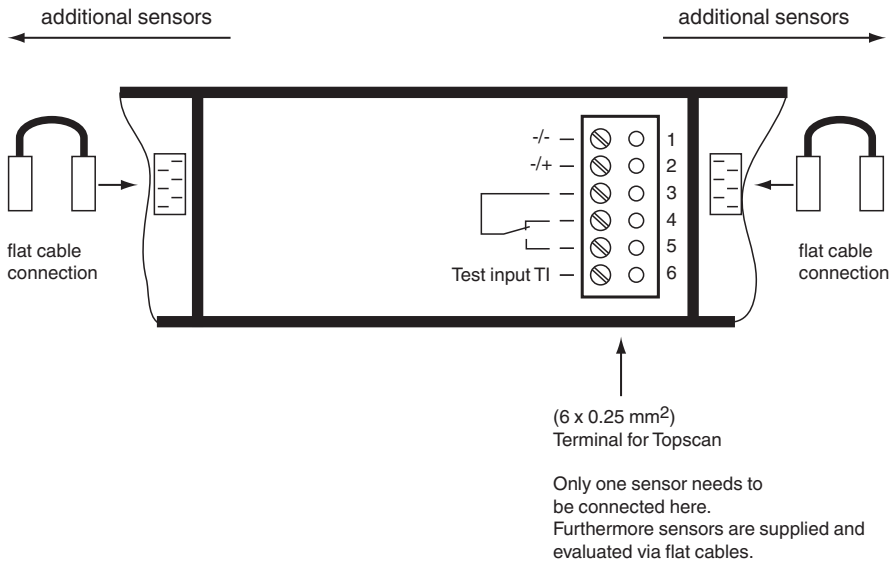

Assembly

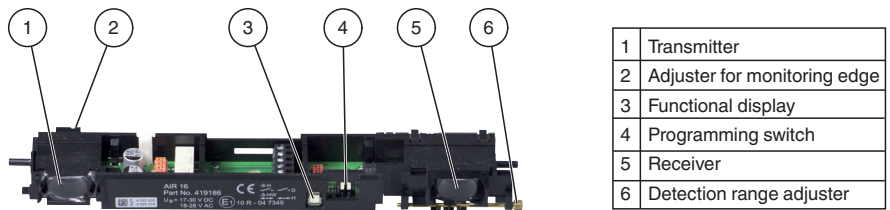

Characteristic Curve

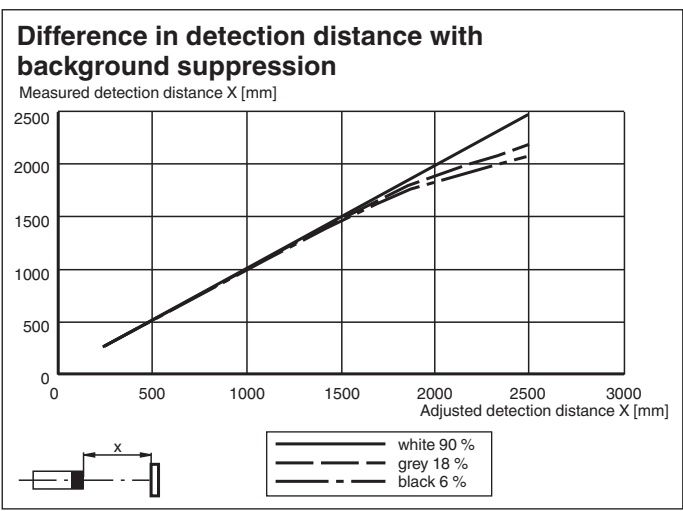

Release date: 2024-07-19 Date of issue: 2024-07-19 Filename: 418042_eng.pdf

Characteristic Curve

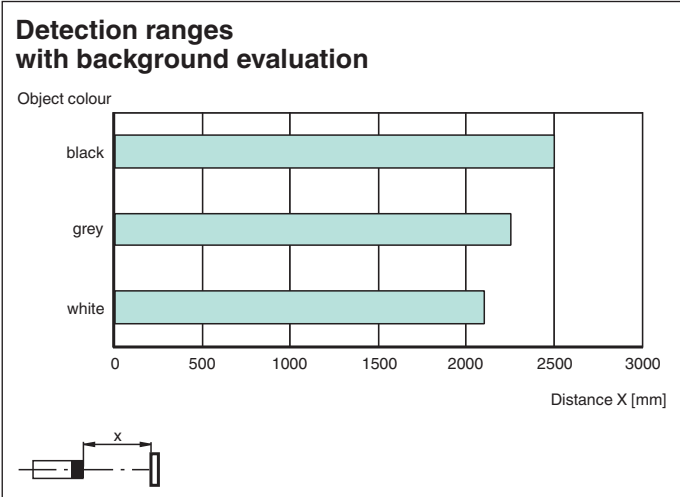
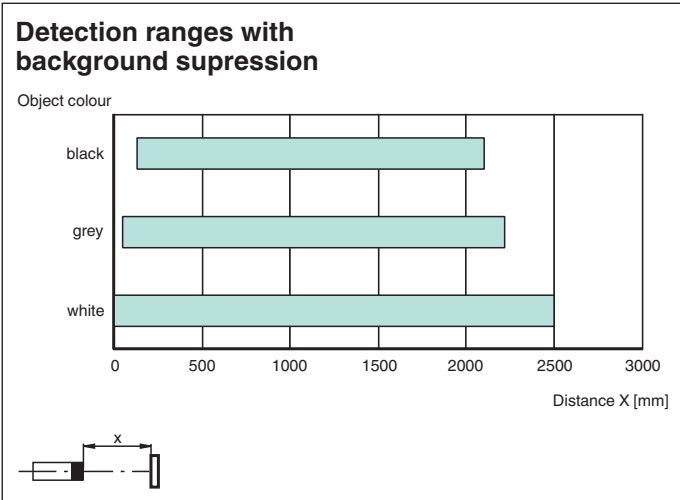
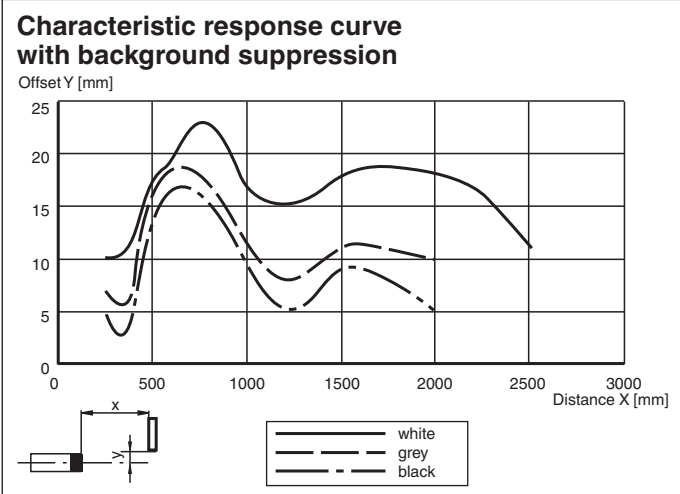

Release date: 2024-07-19 Date of issue: 2024-07-19 Filename: 418042_eng.pdf

Application

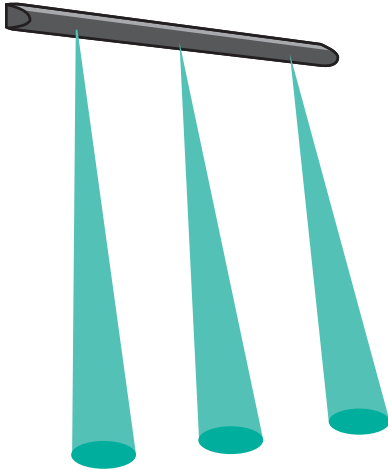

Release date: 2024-07-19 Date of issue: 2024-07-19 Filename: 418042_eng.pdf

Refer to "General Notes Relating to Pepperl+Fuchs Product Information".

Pepperl+Fuchs Group
www.pepperl-fuchs.com

USA: +1 330 486 0001
fa-info@us.pepperl-fuchs.com

Germany: +49 621 776 1111
fa-info@de.pepperl-fuchs.com

Singapore: +65 6779 9091
fa-info@sg.pepperl-fuchs.com

Configuration information

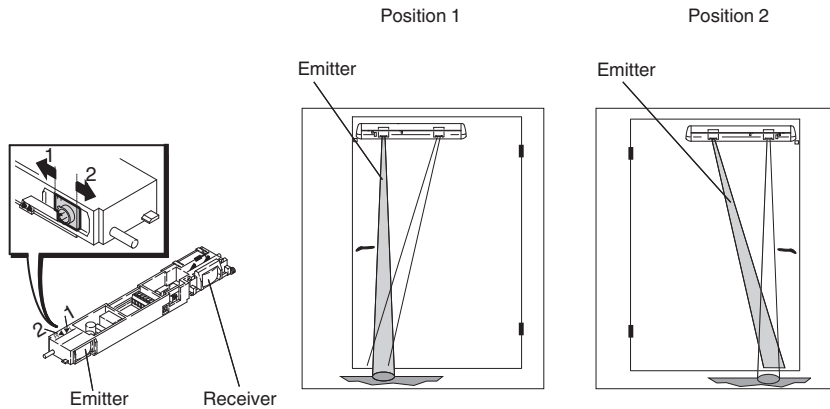

Configuring the Monitoring Edge



The transmitter of each sensor features two beam position settings via which the monitoring edge can be aligned to the left or to the right.

Detection range setting:

1. Rotate the adjustment screw counter-clockwise until the LED illuminates
2. Slowly rotate the adjustment screw clockwise until the LED goes out
3. Then rotate the adjustment screw further by 1/8 of a rotation

 shorter
 longer
 switch approx. 15 cm ... 20 cm
 above ground

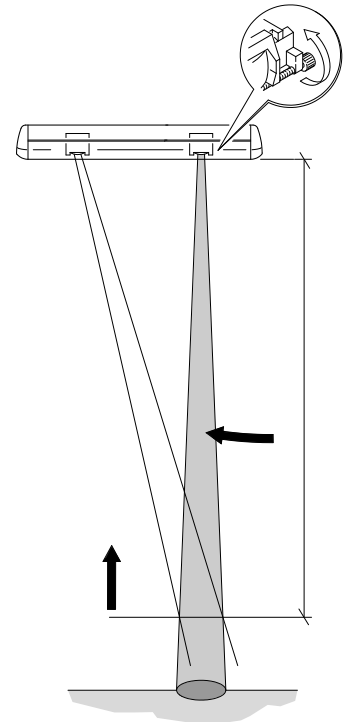

Angle settings:

By rotating the sensor around its rotational axis (1), the offset (2) of the detection point to the wall can be easily changed. The angle setting can be continuously adjusted from 0° to 30°.

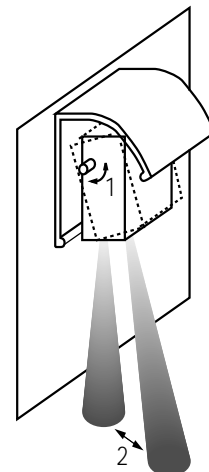

Programming:

Both the switching mode and the operating mode can be configured via the programming switch for each sensor.

Release date: 2024-07-19 Date of issue: 2024-07-19 Filename: 418042_eng.pdf

Test input (TE) — background suppression operating mode

TE	Switching mode	LED	Signal output
Active	Light	Does not illuminate	Closed
Active	Dark	Does not illuminate	Open

Note: only if there is an object in the detection area

Test input (TE) — background evaluation operating mode

TE	Switching mode	LED	Signal output
Active	Light	Illuminates	Open
Active	Dark	Illuminates	Closed

Note: Regardless of whether or not there is an object in the detection area

Light On Switching Mode (H)

A light scanner's output is switched on (activated) if the receiver detects "light", i.e. there is an object in the operating range.

Dark On Switching Mode (D)

A light scanner's output is switched on (activated) if the receiver detects "dark", i.e. there is no object in the operating range.

Programming switch

	Left (1)	Right (2)
Off	Background suppression	Dark on
On	Background evaluation	Light on

Function Principle

The two large-area lenses (one for the infrared transmitter and one for the two photodiode receivers with ambient light filter) have an optical center-to-center distance of approx. 150 mm, resulting in a light spot size of 75 mm x 75 mm. The angle of the two lens systems can be adjusted to each other via a precision gear according to the principle of background/foreground suppression. Such precisely defined focal lengths enable a precision detection range setting of up to 2500 mm.

The detection range can be extended up to 2500 mm and responds to any object in the detection area, with minimal effect from the surface color and structure. Reflection levels that exceed the specified maximum detection range are not detected by the sensor, even with highly reflective objects — for example corrugated aluminum plates or marble floors (with background suppression). The detection fields of several devices can be overlapped without interference.

Background Suppression Operating Mode

In this operating mode, the background is "detected" but not actually evaluated (ignored). A reflection signal from an object within the specified detection area is required as a switching signal.

Background Evaluation Operating Mode

The TopScan2 can also be used with a test option, regardless of whether or not there is an object/person in the detection area. The receiver constantly sees the reflected light from the transmitter when the background is present. Testing is performed by disconnecting the transmitter from the supply voltage.

The background is used as a reflector. If the light beam is broken by an object, a switching signal is triggered.

Application

- Protection mechanism for closing edges on automatic sliding doors and revolving doors
- Anti-collision protection for people/objects in the vicinity of revolving doors
- Edge and pinch protection for sliding doors
- Entry monitoring for buses and trains operated within the public transportation network