

Connections

HAZARDOUS LOCATION
 Class I, Division 1, Groups A, B, C, D
 Class II, Division 1, Groups E, F, G
 Class III, Division 1
 or
 Class I, Zone 0 IIC
 Zone 20 IIIC

NON-HAZARDOUS LOCATION

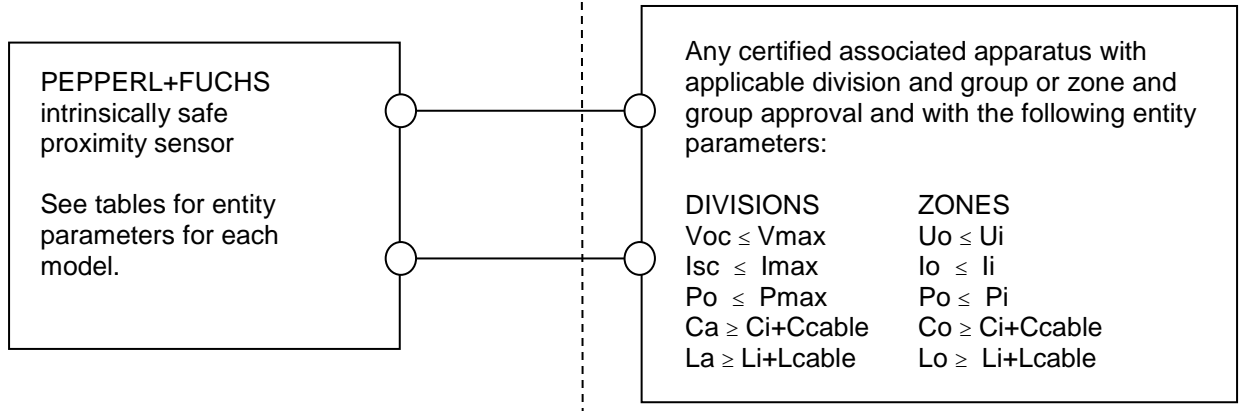

Notes

1. MARKING

- Listee's name or Trade Mark
 - Model number or designation
 - Class-Division marking:
 - Class I, Division 1, Group A, B, C, D, T6...T1
 - And/Or
 - Class II, Division 1, Group E, F, G, T 135 °C
 - And/Or
 - Class III, Division 1, T 135 °C
 - And/Or
 - Class-Zone marking for USA:
 - Class I, Zone 0, AEx ia IIC T6...T1 Ga
 - And/Or,
 - Zone 20, AEx ia IIIC T 135 °C Da
 - And/Or
 - Class-Zone marking for Canada:
 - Ex ia IIC T6...T1 Ga X
 - And/Or,
 - Ex ia IIIC T 135 °C Da X
- The following abbreviations are permitted to be used: Class – Cl, Division – Div, Group – Gp, Zone – Zn
- An indication that the apparatus is intrinsically safe
 - A reference to the control drawing number
 - A reference to ambient temperature range shown under suitable tables in the Control Drawing
 - "WARNING – AVOID ELECTROSTATIC CHARGE – SEE INSTRUCTIONS" and/or "AVERTISSEMENT – DANGER POTENTIEL DE CHARGES ÉLECTROSTATIQUES – VOIR INSTRUCTIONS" for apparatus models according to suitable table in the Control Drawing.
 - A serial number, date code or equivalent

This document contains safety-relevant information. It must not be altered without the authorization of a NE EX		
	Only valid as long as released in EDM	date: 2019-May-21
 PEPPERL+FUCHS Global	Control Drawing Cylindrical inductive proximity sensors	116-0452 Rev. A sheet 1 of 7

2. STANDARDS

Investigation acc. United States Standards: UL 913, UL 60079-0, UL 60079-11 and acc. Canadian National Standards CSA C22.2 NO. 60079-0, CSA C22.2 NO. 60079-11

3. The Entity Concept allows interconnection of an intrinsically safe apparatus with an associated apparatus not specifically examined in combination as a system when the approved values of V_{oc} (or U_o), I_{sc} (or I_o) and P_o for the associated apparatus are less than or equal to V_{max} (or U_i), I_{max} (or I_i) and P_{max} (or P_i) for the intrinsically safe apparatus and the approved values of C_a (or C_o) and L_a (or L_o) for the associated apparatus are greater than $C_i + C_{cable}$ and $L_i + L_{cable}$, respectively, for the intrinsically safe apparatus, where

- $C_{cable} = 60 \text{ pF/ft}$ (197 pF/m) if unknown
- $L_{cable} = 0.20 \text{ }\mu\text{H/ft}$ ($0.66 \text{ }\mu\text{H/m}$) if unknown

4. The sum of all capacitances and inductances, including tolerance and a 10 m cable result to the given values for C_i and L_i for the respective sensor models, shown in Table 1 and Table 2.

5. Wiring methods must be in accordance with all applicable installation requirements of the country in use. For the U.S. see NFPA 70 (NEC) article 504. For Canada see CEC section 18.

6. **WARNING:** Substitution of components may impair intrinsic safety and suitability for hazardous (classified) locations.
AVERTISSEMENT - La substitution de composants peut compromettre la sécurité intrinsèque et l'adéquation à une utilisation en emplacements dangereux.

7. The correlation between the type of connected circuit and the maximum permissible ambient temperature are indicated at the top of Table 1 and Table 2 below.

When assigning the actual sensor to the respective tables, use the model description, which describes the sensor best. Letters and digits describe the different types according to the model description key.

The dots in this type description represent free definable parameters. These free definable parameters can be omitted or replaced by letters or digits.

8. Appropriate measures need to be taken to protect the proximity sensors against mechanical damage due to impact, if they are used within an ambient temperature range between $-60 \text{ }^\circ\text{C}$ and $-20 \text{ }^\circ\text{C}$. An ambient temperature below $-60 \text{ }^\circ\text{C}$ is not permissible.

9. When the following types of proximity sensors are applied acc. to the following classification

- Class I, Division 1, Class II, Division 1 or Class III Division 1 or
- Class I, Zone 0 or Zone 20

as tabulated below, inadmissible electrostatic charge of the plastic housing has to be prevented.

This document contains safety-relevant information. It must not be altered without the authorization of a NE EX		
	Only valid as long as released in EDM	date: 2019-May-21
 PEPPERL+FUCHS Global	Control Drawing Cylindrical inductive proximity sensors	116-0452 Rev. A sheet 2 of 7

Model	Division Classification			Zone Classification	
	Class I, Division 1 for Groups	Class II, Division 1 for Groups	Class III, Division 1 for Class	Class I, Zone 0 for Groups	Zone 20 for Group
NCB1,5...M...N0...	-	-	-	-	-
NCB10-30GM...-N0...	A, B	E, F, G	III	IIC	III
NCB15-30GM...-N0...	A, B	E, F, G	III	IIC	III
NCB2-12GM...-N0...	-	-	-	-	-
NCB4-12GM...-N0...	-	-	-	-	-
NCB5-18GM...-N0...	-	-	-	-	-
NCB8-18GM...-N0...	-	-	-	-	-
NCN15-30GM...-N0...	A, B	E, F, G	III	IIC	III
NCN4-12GM...-N0...	-	-	-	-	-
NCN8-18GM...-N0...	-	-	-	-	-
NJ0,8-5GM-N...	-	-	-	-	-
NJ1,5-10GM-N-Y...	-	-	-	-	-
NJ1,5-18GM-N-D...	-	-	-	-	-
NJ1,5-6,5...-N...	-	-	-	-	-
NJ1,5-8GM-N...	-	-	-	-	-
NJ10-30GM-N...	A, B	E, F, G	III	IIC	III
NJ15-30GK...-N...	A, B	E, F, G	III	IIC	III
NJ15-30GK-N-150...	A, B	E, F, G	III	IIC	III
NJ15-30GM-N...	A, B	E, F, G	III	IIC	III
NJ2-11-N...	-	-	-	-	-
NJ2-11-N-G...	-	-	-	-	-
NJ2-12GM-N...	-	-	-	-	-
NJ4-12GM-N...	-	-	-	-	-
NJ4-30GM-N-200... (amplifier unit)	A, B	-	-	IIC	-
NJ4-30GM-N-200... (oscillator unit)	A, B	-	-	IIC	-
NJ5-18GK-N...	A, B	E, F, G	III	IIC	III
NJ5-18GK-N-150...	A, B	-	-	IIC	-
NJ5-18GM-N...	-	-	-	-	-
NJ8-18GK-N...	A, B	-	-	IIC	-
NJ8-18GK-N-150...	A, B	-	-	IIC	-
NJ8-18GM-N...	-	-	-	-	-

WARNING – AVOID ELECTROSTATIC CHARGE – SEE INSTRUCTIONS
 AVERTISSEMENT – DANGER POTENTIEL DE CHARGES ÉLECTROSTATIQUES – VOIR INSTRUCTIONS

Do not mount the supplied nameplate in dust hazardous areas that can be electrostatically charged.

Information on electrostatic hazards can be found in the technical specification IEC/TS 60079-32-1.

This document contains safety-relevant information. It must not be altered without the authorization of a NE EX		
	Only valid as long as released in EDM	date: 2019-May-21
 PEPPERL+FUCHS Global	Control Drawing Cylindrical inductive proximity sensors	116-0452 Rev. A
		sheet 3 of 7

10. Inadmissible electrostatic charge of parts of the metal housing has to be avoided for the following types of proximity sensors. Dangerous electrostatic charge of parts of the metal housing can be avoided by grounding of these parts whereas very small parts of the metal housing (e.g. screws) do not need to be grounded:

NCB1,5...M...N0...	NCN8-18GM...-N0...	NJ2-12GM-N...
NCB2-12GM...-N0...	NCN15-30GM...-N0...	NJ4-12GM-N...
NCB4-12GM...-N0...	NJ0,8-5GM-N...	NJ4-30GM-N-200...
NCB5-18GM...-N0...	NJ1,5-6,5...-N...	NJ5-18GM-N...
NCB8-18GM...-N0...	NJ1,5-10GM-N-Y...	NJ8-18GM-N...
NCB10-30GM...-N0...	NJ1,5-8GM-N...	NJ10-30GM-N...
NCB15-30GM...-N0...	NJ1,5-18GM-N-D...	NJ15-30GM-N...
NCN4-12GM...-N0...	NJ2-11-N-G...	

11. For the application of the following types of proximity sensors in hazardous locations appropriate measures need to be taken to protect the free resin surface against mechanical damage, if the free resin surface is accessible after installation:

NCB5-18GM20-N0-Y106294
 NJ1,5-10GM-N-Y07451
 NJ15-30GK-N-Y08943

12. The proximity sensors may be provided with a permanently connected cable having the following characteristics:

- Type: flexible jacketed power supply cord
- Rated Voltage: 500 V
- Rated Current: min. 76 mA

This document contains safety-relevant information. It must not be altered without the authorization of a NE EX		
	Only valid as long as released in EDM	date: 2019-May-21
 PEPPERL+FUCHS Global	Control Drawing Cylindrical inductive proximity sensors	116-0452 Rev. A
		sheet 4 of 7

Entity Parameters

**Table 1, Proximity sensors for use in
Class I, Division 1
Class I, Zone 0**

		Type 1 Ui = 16 V Ii = 25 mA Pi = 34 mW					Type 2 Ui = 16 V Ii = 25 mA Pi = 64 mW					Type 3 Ui = 16 V Ii = 52 mA Pi = 169 mW					Type 4 Ui = 16 V Ii = 76 mA Pi = 242 mW					
Maximum permissible ambient temperature in °C for application in temperature class																						
Model	Ci / nF	Li / µH	T6	T5	T4	T3	T2-T1	T6	T5	T4	T3	T2-T1	T6	T5	T4	T3	T2-T1	T6	T5	T4	T3	T2-T1
NCB1,5...M...N0...	90	100	74	89	100	100	100	69	84	100	100	100	51	66	85	85	85	39	54	67	67	67
NCB10-30GM...-N0...	105	100	76	91	100	100	100	73	88	100	100	100	62	77	81	81	81	54	63	63	63	63
NCB15-30GM...-N0...	120	150	74	89	100	100	100	69	84	100	100	100	51	66	74	74	74	39	52	52	52	52
NCB2-12GM...-N0...	90	100	76	91	100	100	100	73	88	100	100	100	62	77	81	81	81	54	63	63	63	63
NCB4-12GM...-N0...	120	50	74	89	100	100	100	69	84	100	100	100	51	66	74	74	74	39	52	52	52	52
NCB5-18GM...-N0...	95	100	76	91	100	100	100	73	88	100	100	100	62	77	81	81	81	54	63	63	63	63
NCB8-18GM...-N0...	120	50	74	89	100	100	100	69	84	100	100	100	51	66	74	74	74	39	52	52	52	52
NCN15-30GM...-N0...	110	100	76	91	100	100	100	73	88	100	100	100	62	77	81	81	81	54	63	63	63	63
NCN4-12GM...-N0...	95	100	76	91	100	100	100	73	88	100	100	100	62	77	81	81	81	54	63	63	63	63
NCN8-18GM...-N0...	95	100	76	91	100	100	100	73	88	100	100	100	62	77	81	81	81	54	63	63	63	63
NJ 0,8-5GM-N...	30	50	73	88	100	100	100	68	83	100	100	100	49	64	67	67	67	36	42	42	42	42
NJ1,5-10GM-N-Y...	20	50	73	88	100	100	100	68	83	100	100	100	49	64	67	67	67	36	42	42	42	42
NJ1,5-18GM-N-D...	50	60	76	91	100	100	100	73	88	100	100	100	62	77	81	81	81	54	63	63	63	63
NJ1,5-6,5...-N...	30	50	73	88	100	100	100	68	83	100	100	100	49	64	67	67	67	36	42	42	42	42
NJ1,5-8GM-N...	30	50	73	88	100	100	100	68	83	100	100	100	49	64	67	67	67	36	42	42	42	42
NJ10-30GM-N...	140	100	76	91	100	100	100	73	88	100	100	100	62	77	81	81	81	54	63	63	63	63
NJ15-30GK...-N...	140	100	73	88	100	100	100	69	84	100	100	100	51	66	80	80	80	39	54	61	61	61
NJ15-30GK-N-150...	140	100	73	88	124	150	150	69	84	119	150	150	51	66	101	150	150	39	54	89	136	136

This document contains safety-relevant information. It must not be altered without the authorization of a NE EX		
	Only valid as long as released in EDM	date: 2019-May-21
	Control Drawing	116-0452 Rev. A
	Cylindrical inductive proximity sensors	sheet 5 of 7
Global		

Type 1 U_i = 16 V l_i = 25 mA P_i = 34 mW	Type 2 U_i = 16 V l_i = 25 mA P_i = 64 mW	Type 3 U_i = 16 V l_i = 52 mA P_i = 169 mW	Type 4 U_i = 16 V l_i = 76 mA P_i = 242 mW
--	--	---	---

Maximum permissible ambient temperature in °C for application in temperature class

Model	Ci / nF	Li / μH	T6	T5	T4	T3	T2-T1	T6	T5	T4	T3	T2-T1	T6	T5	T4	T3	T2-T1	T6	T5	T4	T3	T2-T1
NJ15-30GM-N...	140	100	76	91	100	100	100	73	88	100	100	100	62	77	81	81	81	54	63	63	63	63
NJ2-11-N...	45	50	73	88	100	100	100	66	81	100	100	100	45	60	89	89	89	30	45	74	74	74
NJ2-11-N-G...	30	50	76	91	100	100	100	73	88	100	100	100	62	77	81	81	81	54	63	63	63	63
NJ2-12GM-N...	30	50	76	91	100	100	100	73	88	100	100	100	62	77	81	81	81	54	63	63	63	63
NJ4-12GM-N...	45	50	73	88	100	100	100	68	83	100	100	100	49	64	67	67	67	36	42	42	42	42
NJ4-30GM-N-200...(amp)	70	100	73	88	100	100	100	66	81	100	100	100	45	60	89	89	89	30	45	74	74	74
NJ4-30GM-N-200...(osc)	70	100	73	88	123	188	192	66	81	116	181	186	45	60	95	160	164	30	45	80	145	149
NJ5-18GK-N...	70	50	73	88	100	100	100	69	84	100	100	100	51	66	80	80	80	39	54	61	61	61
NJ5-18GK-N-150...	70	50	73	88	124	150	150	69	84	119	150	150	51	66	101	150	150	39	54	89	136	136
NJ5-18GM-N...	70	50	76	91	100	100	100	73	88	100	100	100	62	77	81	81	81	54	63	63	63	63
NJ8-18GK-N...	70	50	73	88	100	100	100	69	84	100	100	100	51	66	80	80	80	39	54	61	61	61
NJ8-18GK-N-150...	70	50	73	88	124	150	150	69	84	119	150	150	51	66	101	150	150	39	54	89	136	136
NJ8-18GM-N...	70	50	76	91	100	100	100	73	88	100	100	100	62	77	81	81	81	54	63	63	63	63

This document contains safety-relevant information. It must not be altered without the authorization of a NE EX		
	Only valid as long as released in EDM	date: 2019-May-21
	Control Drawing	116-0452 Rev. A
	Cylindrical inductive proximity sensors	sheet 6 of 7
Global		

**Table 2, Proximity sensors for use in
Class II, Division 1, Class III, Division 1 or
Zone 20**

Model	Ci / nF	Li / μ H	Type 1	Type 2	Type 3	Type 4
			Ui = 16 V Ii = 25 mA Pi = 34 mW	Ui = 16 V Ii = 25 mA Pi = 64 mW	Ui = 16 V Ii = 52 mA Pi = 169 mW	Ui = 16 V Ii = 76 mA Pi = 242 mW
maximum permissible ambient temperature in °C						
NCB1,5...M...N0...	90	100	100	100	85	67
NCB10-30GM...-N0...	105	100	100	100	81	63
NCB15-30GM...-N0...	120	150	100	100	85	67
NCB2-12GM...-N0...	90	100	100	100	81	63
NCB4-12GM...-N0...	120	50	100	100	85	67
NCB5-18GM...-N0...	95	100	100	100	81	63
NCB8-18GM...-N0...	120	50	100	100	85	67
NCN15-30GM...-N0...	110	100	100	100	81	63
NCN4-12GM...-N0...	95	100	100	100	81	63
NCN8-18GM...-N0...	95	100	100	100	81	63
NJ0,8-5GM-N...	30	50	100	100	67	41
NJ1,5-10GM-N-Y...	20	50	100	100	67	41
NJ1,5-18GM-N-D...	50	60	100	100	81	63
NJ1,5-6,5...-N...	30	50	100	100	67	41
NJ1,5-8GM-N...	30	50	100	100	67	41
NJ10-30GM-N...	140	100	100	100	81	63
NJ15-30GK...-N...	140	100	100	100	80	61
NJ15-30GK-N-150...	140	100	100	100	100	89
NJ15-30GM-N...	140	100	100	100	81	63
NJ2-11-N...	45	50	100	100	89	74
NJ2-11-N-G...	30	50	100	100	81	63
NJ2-12GM-N...	30	50	100	100	81	63
NJ4-12GM-N...	45	50	100	100	67	41
NJ4-30GM-N-200... (amp)	70	100	100	100	89	74
NJ4-30GM-N-200... (osc)	70	100	100	100	95	80
NJ5-18GK-N...	70	50	100	100	80	61
NJ5-18GK-N-150...	70	50	100	100	100	89
NJ5-18GM-N...	70	50	100	100	81	63
NJ8-18GK-N...	70	50	100	100	80	61
NJ8-18GK-N-150...	70	50	100	100	100	89
NJ8-18GM-N...	70	50	100	100	81	63

This document contains safety-relevant information. It must not be altered without the authorization of a NE EX		
	Only valid as long as released in EDM	date: 2019-May-21
 PEPPERL+FUCHS Global	Control Drawing	116-0452 Rev. A
	Cylindrical inductive proximity sensors	sheet 7 of 7