

Connections

HAZARDOUS LOCATION
 Class I, Division 1, Groups A, B, C, D
 Class II, Division 1, Groups E, F, G
 Class III, Division 1
 or
 Class I, Zone 0 IIC
 Zone 20 IIIC

NON-HAZARDOUS LOCATION

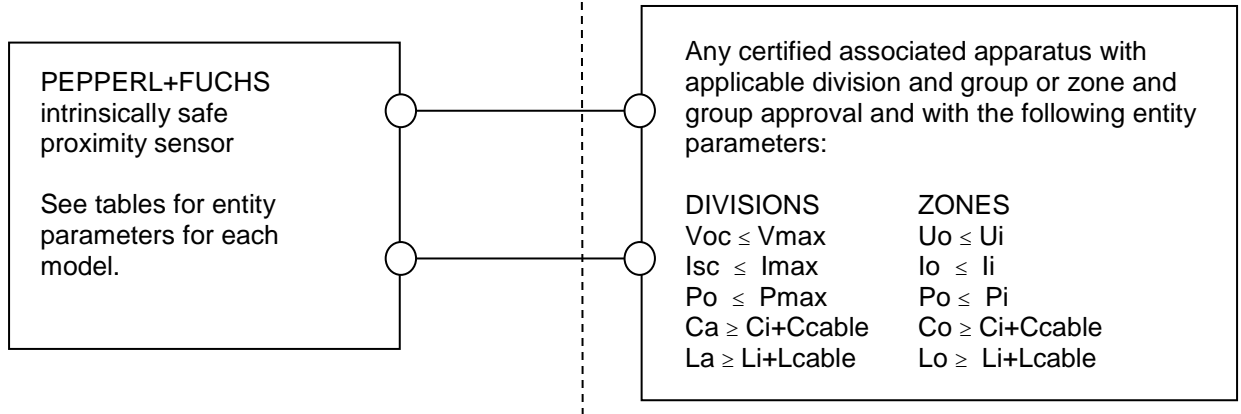

Notes

1. MARKING

- Listee's name or Trade Mark
 - Model number or designation
 - Class-Division marking:
 - Class I, Division 1, Group A, B, C, D, T6...T1
 - And/Or
 - Class II, Division 1, Group E, F, G, T 135 °C
 - And/Or
 - Class III, Division 1, T 135 °C
 - And/Or
 - Class-Zone marking for USA:
 - Class I, Zone 0, AEx ia IIC T6...T1 Ga
 - And/Or,
 - Zone 20, AEx ia IIIC T 135 °C Da
 - And/Or
 - Class-Zone marking for Canada:
 - Ex ia IIC T6...T1 Ga X
 - And/Or,
 - Ex ia IIIC T 135 °C Da X
- The following abbreviations are permitted to be used: Class – Cl, Division – Div, Group – Gp, Zone – Zn
- An indication that the apparatus is intrinsically safe
 - A reference to the control drawing number
 - A reference to ambient temperature range shown under suitable tables in the Control Drawing
 - "WARNING – AVOID ELECTROSTATIC CHARGE – SEE INSTRUCTIONS" and/or "AVERTISSEMENT – DANGER POTENTIEL DE CHARGES ÉLECTROSTATIQUES – VOIR INSTRUCTIONS" for apparatus models according to suitable table in the Control Drawing.
 - A serial number, date code or equivalent

This document contains safety-relevant information. It must not be altered without the authorization of a NE EX		
	Only valid as long as released in EDM	date: 2019-Apr-04
 PEPPERL+FUCHS Global	Control Drawing SN-type inductive proximity sensors	116-0454
		sheet 1 of 6

2. STANDARDS

Investigation acc. United States Standards: UL 913, UL 60079-0, UL 60079-11 and acc. Canadian National Standards CSA C22.2 NO. 60079-0, CSA C22.2 NO. 60079-11

3. The Entity Concept allows interconnection of an intrinsically safe apparatus with an associated apparatus not specifically examined in combination as a system when the approved values of V_{oc} (or U_o), I_{sc} (or I_o) and P_o for the associated apparatus are less than or equal to V_{max} (or U_i), I_{max} (or I_i) and P_{max} (or P_i) for the intrinsically safe apparatus and the approved values of C_a (or C_o) and L_a (or L_o) for the associated apparatus are greater than $C_i + C_{cable}$ and $L_i + L_{cable}$, respectively, for the intrinsically safe apparatus, where

- $C_{cable} = 60 \text{ pF/ft}$ (197 pF/m) if unknown
- $L_{cable} = 0.20 \text{ }\mu\text{H/ft}$ ($0.66 \text{ }\mu\text{H/m}$) if unknown

4. The sum of all capacitances and inductances, including tolerance and a 10 m cable result to the given values for C_i and L_i for the respective sensor models, shown in Table 1 and Table 2.
5. Wiring methods must be in accordance with all applicable installation requirements of the country in use. For the U.S. see NFPA 70 (NEC) article 504. For Canada see CEC section 18.
6. **WARNING:** Substitution of components may impair intrinsic safety and suitability for hazardous (classified) locations.
AVERTISSEMENT - La substitution de composants peut compromettre la sécurité intrinsèque et l'adéquation à une utilisation en emplacements dangereux.
7. The correlation between the type of connected circuit and the maximum permissible ambient temperature are indicated at the top of Table 1 and Table 2 below.

When assigning the actual sensor to the respective table, use the type description, which describes the sensor best. Letters and digits describe the different types according to the type description key.

The dots in this type description represent free definable parameters. These free definable parameters can be omitted or replaced by letters or digits.

8. Appropriate measures need to be taken to protect the proximity sensors against mechanical damage due to impact, if they are used within an ambient temperature range between $-60 \text{ }^\circ\text{C}$ and $-20 \text{ }^\circ\text{C}$. An ambient temperature below $-60 \text{ }^\circ\text{C}$ is not permissible.

This document contains safety-relevant information. It must not be altered without the authorization of a NE EX		
	Only valid as long as released in EDM	date: 2019-Apr-04
 PEPPERL+FUCHS Global	Control Drawing SN-type inductive proximity sensors	116-0454
		sheet 2 of 6

9. When the following types of proximity sensors are applied acc. to the following classification

- Class I, Division 1, Class II, Division 1 or Class III Division 1 or
- Class I, Zone 0 or Zone 20

as tabulated below, inadmissible electrostatic charge of the plastic housing has to be prevented.

Type	Division Classification			Zone Classification	
	Class I, Division 1	Class II, Division 1	Class III, Division 1	Class I, Zone 0	Zone 20
	for Groups	for Groups	for Class	for Groups	for Group
NJ2-11-SN...	-	-	-	-	-
NJ2-11-SN-G...	-	-	-	-	-
NJ2-12GK-SN...	-	-	-	-	-
NJ3-18GK-S1N...	A, B	E, F, G	III	IIC	III
NJ4-12GK-SN-Y197959	A, B	-	-	IIC	-
NJ4-12GK-SN-Y197960	A, B	-	-	IIC	-
NJ4-12GK-SN...	-	-	-	-	-
NJ5-18GK-SN...	A, B	E, F, G	III	IIC	III
NJ5-30GK-S1N...	A, B	E, F, G	III	IIC	III
NJ6-22-SN...	A, B	E, F, G	III	IIC	III
NJ6-22-SN-G...	-	-	-	-	-
NJ6S1+U...+N...	A, B	E, F, G	III	IIC	III
NJ8-18GK-SN...	A, B	-	-	IIC	-
NJ10-30GK-SN...	A, B	E, F, G	III	IIC	III
NJ15-30GK-SN...	A, B	E, F, G	III	IIC	III
NJ15S+U...+N...	A, B	E, F, G	III	IIC	III
NJ20S+U...+N...	A, B	E, F, G	III	IIC	III
SJ2-SN...	-	-	-	-	-
SJ2-S1N...	-	-	-	-	-
SJ3,5-S1N...	-	E, F, G	III	-	III
SJ3,5-SN...	-	E, F, G	III	-	III

WARNING – AVOID ELECTROSTATIC CHARGE – SEE INSTRUCTIONS

AVERTISSEMENT – DANGER POTENTIEL DE CHARGES ÉLECTROSTATIQUES – VOIR INSTRUCTIONS

Do not mount the supplied nameplate in dust hazardous areas that can be electrostatically charged.

Information on electrostatic hazards can be found in the technical specification IEC/TS 60079-32-1.

10. Inadmissible electrostatic charge of parts of the metal housing has to be avoided for the following types of proximity sensors. Dangerous electrostatic charge of parts of the metal housing can be avoided by grounding of these parts whereas very small parts of the metal housing (e.g. screws) do not need to be grounded:

NJ2-11-SN-G...

NJ6S1+U3+N...

NJ15S+U3+N...

NJ20S+U3+N...

NJ6-22-SN-G...

NJ6S1+U4+N...

NJ15S+U4+N...

NJ20S+U4+N...

This document contains safety-relevant information. It must not be altered without the authorization of a NE EX		
	Only valid as long as released in EDM	date: 2019-Apr-04
 PEPPERL+FUCHS Global	Control Drawing SN-type inductive proximity sensors	116-0454
		sheet 3 of 6

11. For the application of the following types of proximity sensors in hazardous locations appropriate measures need to be taken to protect the free resin surface against mechanical damage, if the free resin surface is accessible after installation:

SJ2-SN...	SJ3,5-S1N...
SJ2-S1N...	SJ3,5-SN...

12. When the following types of proximity sensors are applied acc. to the following classification

- Class I, Division 1 or
- Class I, Zone 0

the maximum permissible mass fractions of metallic materials are exceeded for the following types of proximity sensors.

In hazardous areas requiring the application of Class I, Division 1 equipment, resp. Class I, Zone 0 equipment, it shall be ensured by appropriate measures that an ignition hazard due to impact or friction effects cannot occur.

NJ6S1+U3+N...	NJ15S+U3+N...	NJ20S+U3+N...
NJ6S1+U4+N...	NJ15S+U4+N...	NJ20S+U4+N...

13. The proximity sensors may be provided with a permanently connected cable having the following characteristics:

- Type: flexible jacketed power supply cord
- Rated Voltage: 500 V
- Rated Current: min. 76 mA

This document contains safety-relevant information. It must not be altered without the authorization of a NE EX		
	Only valid as long as released in EDM	date: 2019-Apr-04
 PEPPERL+FUCHS Global	Control Drawing SN-type inductive proximity sensors	116-0454 sheet 4 of 6

Entity Parameters

**Table 1, Proximity sensors for use in
Class I, Division 1
Class I, Zone 0**

			Type 1 Ui = 16 V li = 25 mA Pi = 34 mW			Type 2 Ui = 16 V li = 25 mA Pi = 64 mW			Type 3 Ui = 16 V li = 52 mA Pi = 169 mW			Type 4 Ui = 16 V li = 76 mA Pi = 242 mW		
			Maximum permissible ambient temperature in °C for application in temperature class											
Model	Ci / nF	Li / µH	T6	T5	T4-T1	T6	T5	T4- T1	T6	T5	T4- T1	T6	T5	T4- T1
NJ2-11-SN...	50	150	73	88	100	66	81	100	45	60	89	30	45	74
NJ2-11-SN-G...	50	150	76	91	100	73	88	100	62	77	81	54	63	63
NJ2-12GK-SN...	50	150	73	88	100	69	84	100	51	66	80	39	54	61
NJ3-18GK-S1N...	70	200	73	88	100	69	84	100	51	66	80	39	54	61
NJ4-12GK-SN...	70	150	73	88	100	69	84	100	51	66	80	39	54	61
NJ5-18GK-SN...	120	200	73	88	100	69	84	100	51	66	80	39	54	61
NJ5-30GK-S1N...	100	200	73	88	100	69	84	100	51	66	80	39	54	61
NJ6-22-SN...	110	150	73	88	100	69	84	100	51	66	80	39	54	61
NJ6-22-SN-G...	110	150	76	91	100	73	88	100	62	77	81	54	63	63
NJ6S1+U...+N...	180	150	73	88	100	69	84	100	51	66	80	39	54	61
NJ8-18GK-SN...	120	200	73	88	100	69	84	100	51	66	80	39	54	61
NJ10-30GK-SN...	120	150	73	88	100	69	84	100	51	66	80	39	54	61
NJ15-30GK-SN...	120	180	73	88	100	69	84	100	51	66	80	39	54	61
NJ15S+U...+N...	180	150	73	88	100	66	81	100	45	60	89	30	45	74
NJ20S+U...+N...	200	150	73	88	100	66	81	100	45	60	89	30	45	74
SJ2-SN...	30	100	73	88	100	66	81	100	45	60	78	30	45	57
SJ2-S1N...	60	100	73	88	100	66	81	100	45	60	78	30	45	57
SJ3,5-S1N...	30	100	73	88	100	66	81	100	45	60	89	30	45	74
SJ3,5-SN...	30	100	73	88	100	66	81	100	45	60	89	30	45	74

This document contains safety-relevant information. It must not be altered without the authorization of a NE EX		
Only valid as long as released in EDM		date: 2019-Apr-04
 PEPPERL+FUCHS Global	Control Drawing	116-0454
	SN-type inductive proximity sensors	sheet 5 of 6

**Table 2, Proximity sensors for use in
Class II, Division 1, Class III, Division 1 or
Zone 20**

			Type 1 Ui = 16 V Ii = 25 mA Pi = 34 mW	Type 2 Ui = 16 V Ii = 25 mA Pi = 64 mW	Type 3 Ui = 16 V Ii = 52 mA Pi = 169 mW	Type 4 Ui = 16 V Ii = 76 mA Pi = 242 mW
Model	Ci / nF	Li / µH	maximum permissible ambient temperature in °C			
NJ2-11-SN...	50	150	100	100	89	74
NJ2-11-SN-G...	50	150	100	100	81	63
NJ2-12GK-SN...	50	150	100	100	80	61
NJ3-18GK-S1N...	70	200	100	100	80	61
NJ4-12GK-SN...	70	150	100	100	80	61
NJ5-18GK-SN...	120	200	100	100	80	61
NJ5-30GK-S1N...	100	200	100	100	80	61
NJ6-22-SN...	110	150	100	100	80	61
NJ6-22-SN-G...	110	150	100	100	81	63
NJ6S1+U...+N...	180	150	100	100	80	61
NJ8-18GK-SN...	120	200	100	100	80	61
NJ10-30GK-SN...	120	150	100	100	80	61
NJ15-30GK-SN...	120	180	100	100	80	61
NJ15S+U...+N...	180	150	100	100	89	74
NJ20S+U...+N...	200	150	100	100	89	74
SJ2-SN...	30	100	100	100	78	57
SJ2-S1N...	60	100	100	100	78	57
SJ3,5-S1N...	30	100	100	100	89	74
SJ3,5-SN...	30	100	100	100	89	74

This document contains safety-relevant information. It must not be altered without the authorization of a NE EX		
	Only valid as long as released in EDM	date: 2019-Apr-04
 PEPPERL+FUCHS Global	Control Drawing SN-type inductive proximity sensors	116-0454
		sheet 6 of 6