

Elektrischer Anschluss

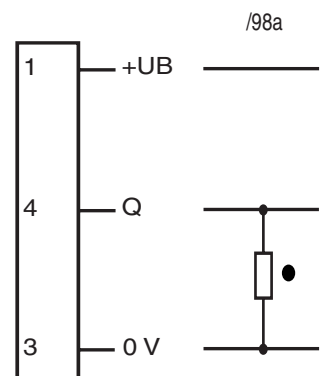

● = dunkelschaltend, ○ = hellschaltend

Electrical connection

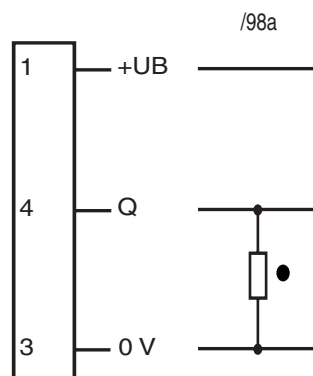

● = dark on, ○ = light on

Adressen/Addresses

Worldwide Head Office
Pepperl+Fuchs GmbH
Koenigsberger Allee 87
68307 Mannheim
Germany
Telephone: +49 621 776-0
Telefax: +49 621 776-1000
eMail: info@de.pepperl-fuchs.com

USA Head Office
Pepperl + Fuchs Inc.
1600 Enterprise Parkway
TWINSBURG OHIO, 44087
USA
Telephone +1 330 425-3555
Telefax +1 330 425-4607
eMail sales@us.pepperl-fuchs.com

Asia Pacific Head Office
Pepperl + Fuchs PTE LTD
P+F Building
18 Ayer Rajah Crescent
139942 SINGAPORE
Singapore
Company Registration No. 199003130E
Telephone +65 6779 9091
Telefax +65 6873 1637
eMail sales@sg.pepperl-fuchs.com

<http://www.pepperl-fuchs.com>

Gabellichtschranke Fork type light beam switch

GL50-2362

CE



Doc. No.: 45-1584
DIN A3 -> DIN A7
Part. No.: 418716
Date: 08/17/2005

PEPPERL+FUCHS
VISOLUX

Technische Daten

Allgemeine Daten		
Lichtsender		IREDD
Prüfungen		EN 60947-5-2
Kennzeichnung		CE
Hindemisgröße		2 mm
Gabelweite		50 mm
Lichtart		infrarot, Wechslicht
Fremdlichtgrenze		100000 Lux
Anzeigen/Bedienelemente		
Funktionsanzeige		LED rot, leuchtet bei unbelichtetem Empfänger (im Anschlußstecker)
Bedienelemente		Empfindlichkeitseinsteller, Hell-/Dunkel-Umschalter
Elektrische Daten		
Betriebsspannung		10 ... 30 V DC
Welligkeit		10 %
Leerlaufstrom	I_0	20 mA
Ausgang		
Schaltungsart		hell-/dunkelschaltend
Signaloutput		1 PNP-Ausgang, kurzschlussfest, verpolsicher, offener Kollektor
Schaltspannung		max. 30 V DC
Schaltstrom		max. 200 mA
Schaltfrequenz	f	70 Hz
Ansprechzeit		5 ms
Umgebungsbedingungen		
Umgebungstemperatur		-20 ... 60 °C (253 ... 333 K)
Lagertemperatur		-20 ... 75 °C (253 ... 348 K)
Mechanische Daten		
Schutzart		IP67
Anschluss		M8-Stecker, 3-polig
Material		
Gehäuse		Aluminium
Lichtaustritt		Glas
Masse		60 g

Technical data

General specifications		
Light source		IREDD
Tests		EN 60947-5-2
Marking		CE
Obstacle size		2 mm
Fork width		50 mm
Light type		infrared, modulated light
Ambient light limit		100000 Lux
Indicators/operating means		
Function display		nicht uebersetzt! (nicht uebersetzt!)
Operating elements		Sensitivity adjuster, light/dark switch
Electrical specifications		
Operating voltage		10 ... 30 V DC
Ripple		10 %
No-load supply current	I_0	20 mA
Output		
Switching type		light/dark switching
Signal output		1 PNP output, short-circuit proof, protected from reverse polarity, open collector
Switching voltage		max. 30 V DC
Switching current		max. 200 mA
Switching frequency	f	70 Hz
Response time		5 ms
Ambient conditions		
Ambient temperature		-20 ... 60 °C (253 ... 333 K)
Storage temperature		-20 ... 75 °C (253 ... 348 K)
Mechanical specifications		
Protection degree		IP67
Connection		M8 connector, 3-pin
Material		
Housing		aluminium
Optical face		glass
Mass		60 g

Sicherheitshinweise:

- Vor der Inbetriebnahme Betriebsanleitung lesen
- Anschluss, Montage und Einstellung nur durch Fachpersonal
- Kein Sicherheitsbauteil gemäß EU-Maschinenrichtlinie, darf nicht für Personenschutz oder NOT-AUS-Funktion verwendet werden.

Security Instructions:

- Read the operating instructions before attempting commissioning
- Installation, connection and adjustments should only be undertaken by specialist personnel
- No safety compolltection of personnel or EMERGENCY-STOP functions.

Abmessungen

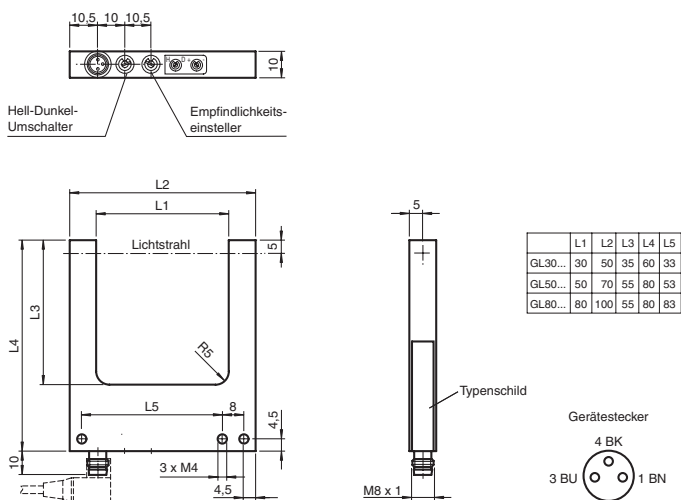

alle Maße in mm

Dimensions

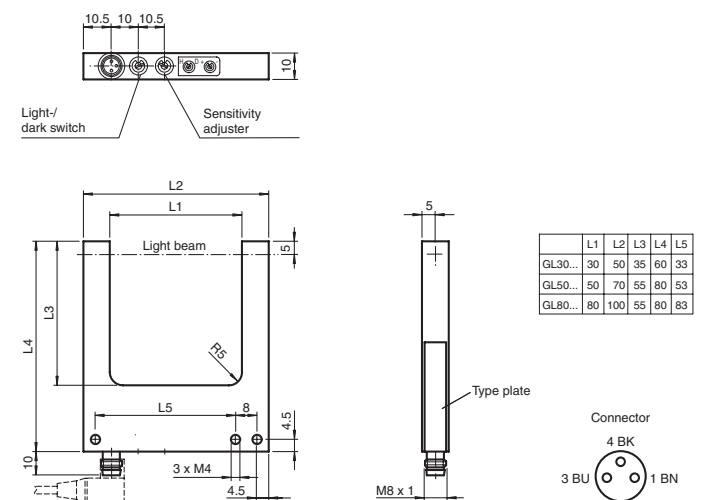

all dimensions in mm
