

**Understanding automation.
Setting standards.
Redefining product diversity.**

Proximity Sensors
Product Overview



Your automation, our passion.

 **PEPPERL+FUCHS**

Find Your Device in Just a Few Clicks

Go online. Specify your requirements. Select your device. You can find the right solution for your application in just a few clicks. If you have any questions, our experts are available to take your call.

Online Search on the Pepperl+Fuchs Website

Enter the model number in the search field on the Pepperl+Fuchs website and get to your product selection immediately. Model numbers can be found in this brochure in the technical data summaries. Or you can navigate through our range of product families and groups. Product selectors help you select the optimal device.

For example,
"NB*-L2*"

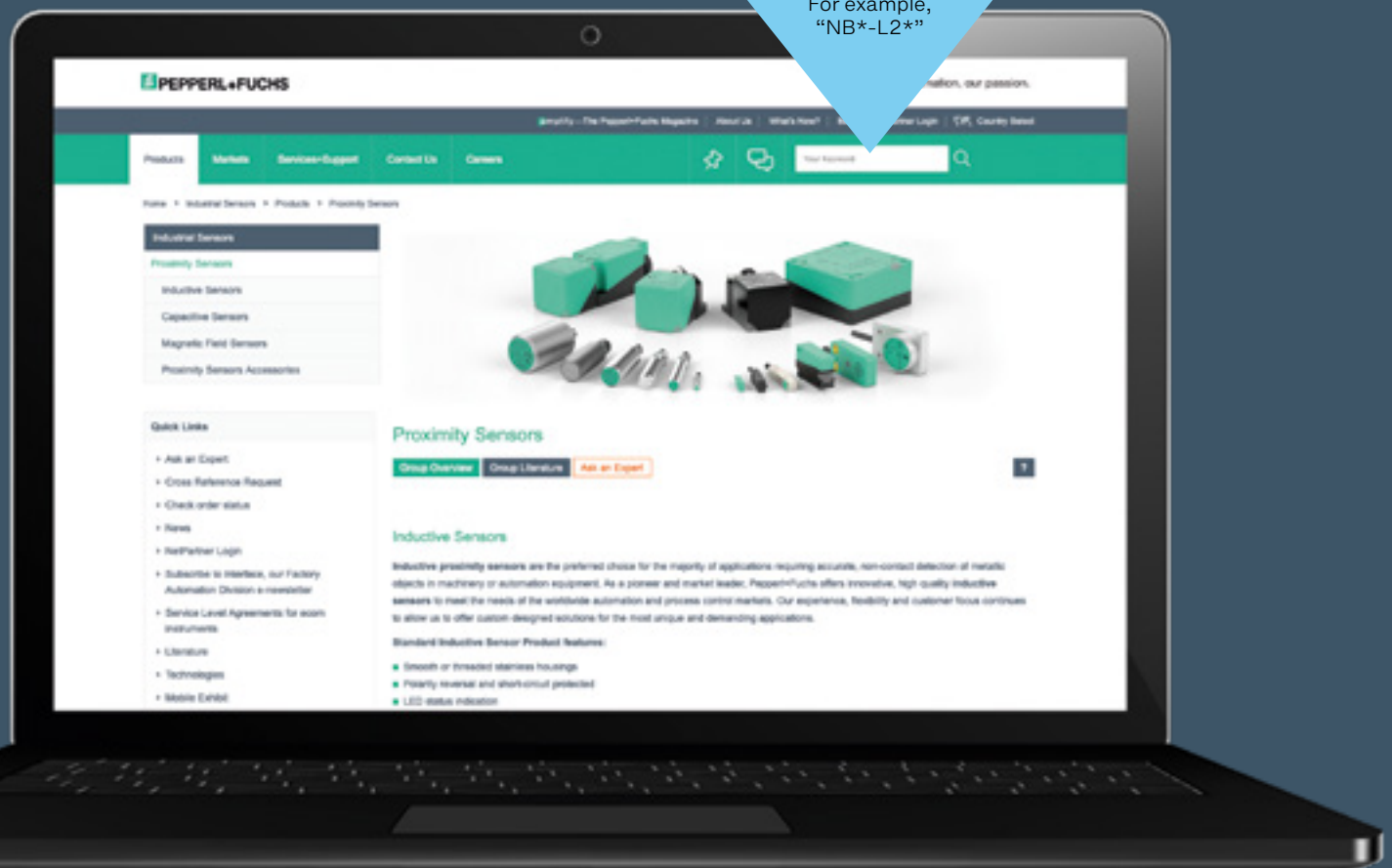

For more information, visit
pepperl-fuchs.com/pf-proximity

Contents

Development and History—The Original: Sensor Solutions Directly from the Inventor	6
Quality Promise	8
Standard Inductive Sensors	10
Cube-Style Standard Inductive Sensors	12
Cylindrical Standard Inductive Sensors	18
Inductive Sensors for Specific Requirements	24
Ring and Slot Sensors	26
Weld-Proof Sensors	28
Reduction Factor 1 Sensors	30
Metal Face Sensors	32
Pressure-Resistant Sensors	34
High Temperature Sensors	36
Safety Sensors	38
Sensors for Hazardous Areas	40
Sensors for Valve Position Detection	44
Mobile Equipment Sensors	48
Capacitive Sensors	50
Magnetic Field Sensors	52
Accessories	54
Customized Sensors and Systems	56

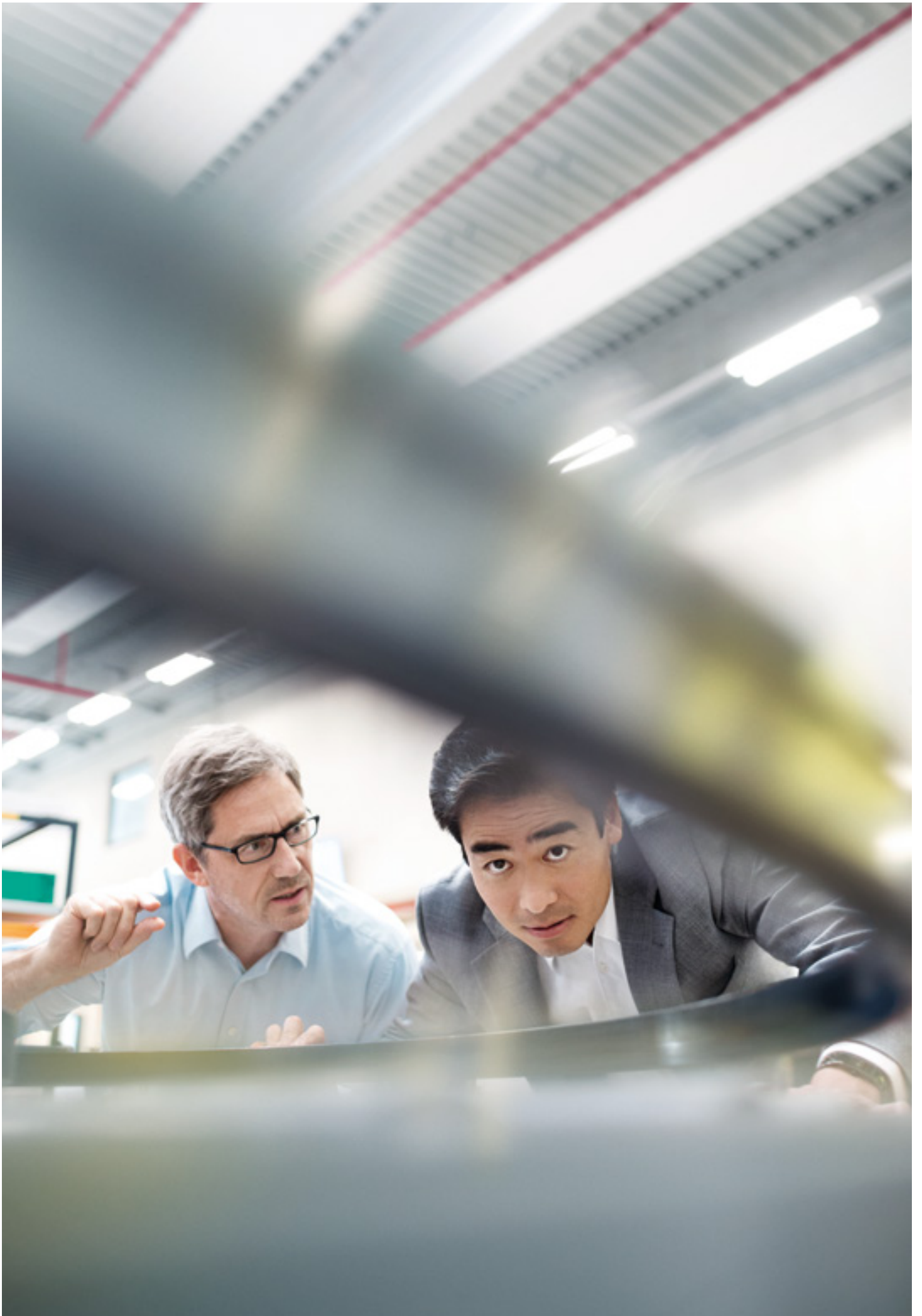

Innovative Solutions. Perfect Applications.

As a technology leader in industrial sensor technology and a pioneer in electrical explosion protection, Pepperl+Fuchs has been developing components and solutions for over 70 years. Above all, our goal is to offer the perfect solutions for our customers' applications. This is only possible with close collaboration. Not only do we share our passion for automation with customers—we also share our in-depth expertise and experience.

Forging ahead with new ideas and finding new approaches is what drives us. This is the foundation for technologically advanced solutions that are tailored to individual applications and geared toward future requirements. Creating customer-focused solutions to meet today's and tomorrow's challenges is at the center of everything we do. And Industry 4.0 makes this more important than ever. Pepperl+Fuchs is re-envisioning tried-and-true technologies and developing innovations that pave the way for networked production and communication that transcends your company's boundaries. Our innovation—your competitive advantage.

For more information, visit us online:

www.pepperl-fuchs.com

Development and History

The Original: Sensor Solutions Directly from the Inventor

Inventing the proximity sensor and introducing the first magnetic amplifier for intrinsically safe circuits were just the start—forging ahead with innovative ideas has a long tradition at Pepperl+Fuchs. The ability to identify new solutions and markets early on is still key to providing customers around the world with the best sensor solutions for their applications.

From an Individual Solution to a Success Story

Company founders Ludwig Fuchs and Walter Pepperl embodied a pioneering spirit and technical know-how. They drew on their experience in broadcasting technology for a customer who wanted to replace mechanical contacts with noncontact alternatives. Thus, in 1958, the company developed the first proximity sensor, daring to employ a completely new technology. What was intended as a customer-specific solution for intrinsically safe circuits in the chemical industry quickly impressed others with its almost unlimited service life. The sensors quickly found their way into a variety of industries and became a worldwide success story.

Committed to Quality from the Start

Right from the beginning, Pepperl+Fuchs proximity sensors stood for quality and reliability. The company ensures its portfolio is always on the cutting edge of technology with the highest quality standards and test criteria far beyond the normative requirements.

At the same time, the inventor of the proximity sensor always has its eye on the future. This has enabled it to continue to develop and perfect the technology. Building on its technical know-how and market experience, Pepperl+Fuchs offers customers consulting expertise at subsidiaries around the world. And if the perfect sensor solution is not already available in its comprehensive portfolio, Pepperl+Fuchs experts partner with customers to develop custom products—tailored to the unique requirements of their application.



Quality Promise

Quality Standards That Exceed Even the Highest Demands

At Pepperl+Fuchs, quality stands for much more than simply complying with the prescribed standards. The company aims to offer the best products on the market, so it applies test criteria that far exceed the requirements. High-quality, customer-oriented sensor solutions are developed based on decades of experience, expert knowledge of the industry, and in-depth technical know-how.

Expertise across All Industries

The requirements for sensor solutions in factory automation are as diverse as the industries that use them. In-depth knowledge of the wealth of application- and approval-specific requirements is essential to support customers across the globe with their individual processes—from vehicle approval to complex specifications for offshore or hazardous-location applications. Decades of experience in all industries makes Pepperl+Fuchs an expert partner for customers all over the world.

Strict Quality and Performance Standards

Ensuring the highest quality standards across the entire portfolio is both a fundamental requirement and a driving force for Pepperl+Fuchs. The company relies on rigorous quality management and an in-house audit department with criteria far beyond the normative requirements. A range of tests are

carried out, including environmental tests that verify optimal functionality under extreme loads. In the mobile equipment range, for instance, testing includes:

- Humidity tests (according to DIN EN 60068-2-38)
- Repeated temperature cycles
- Chemical resistance testing through exposure to vehicle and hydraulic oil, brake fluid, battery acid, and road salt

These strict criteria ensure that Pepperl+Fuchs devices have a long service life, are incredibly reliable, and exceed the most stringent global performance standards. They are available with all major international certifications and approvals, such as:

- E1 approval for mobile equipment
- SIL and PL certification
- DNV GL for marine approval
- ATEX Directive 2014/34/EU, IECEx, UL Hazardous Locations, Ex NEPSI for hazardous areas
- Special approvals for specific countries and applications (e. g., ANZ-Ex/Mining Queensland)

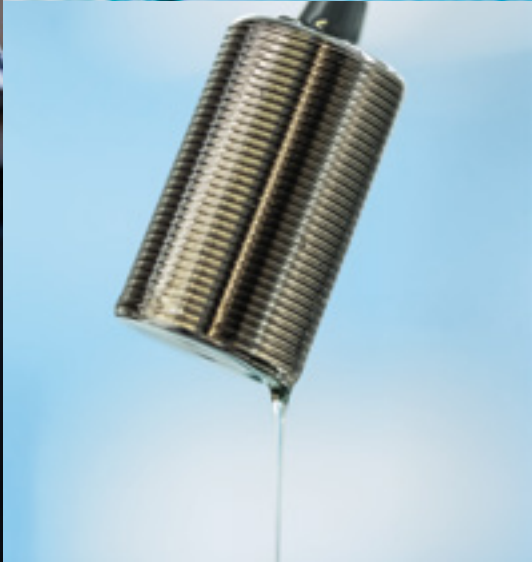
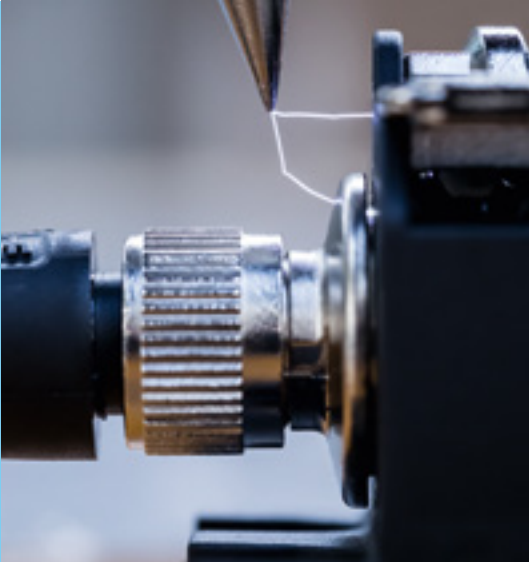

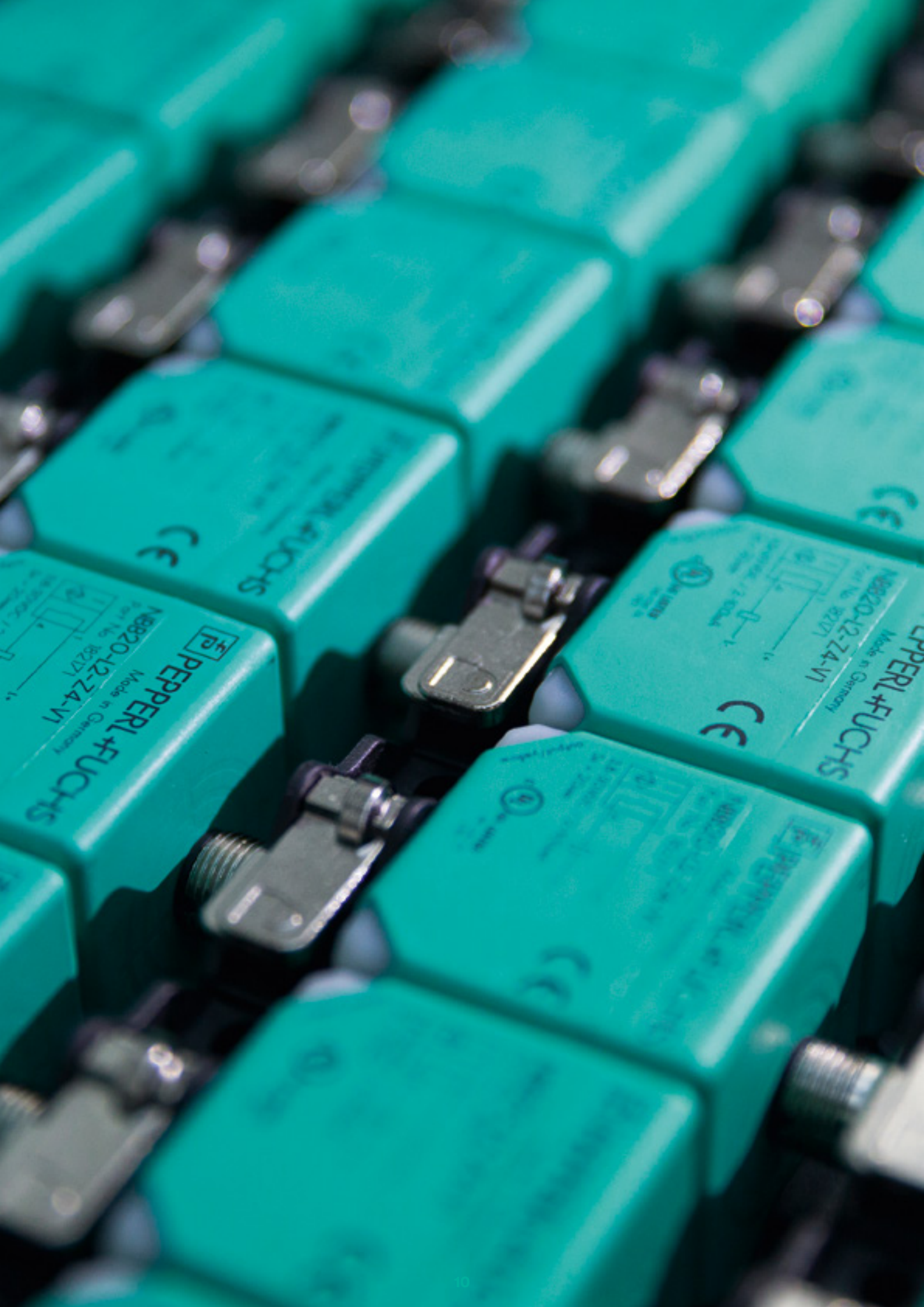

CE

PEPPERL+FUCHS

PEPPERL+FUCHS
N8820-12-Z4-V1
Made in Germany

CE

PEPPERL+FUCHS
N8820-12-Z4-V1
Made in Germany

PEPPERL+FUCHS
N8820-12-Z4-V1
Made in Germany

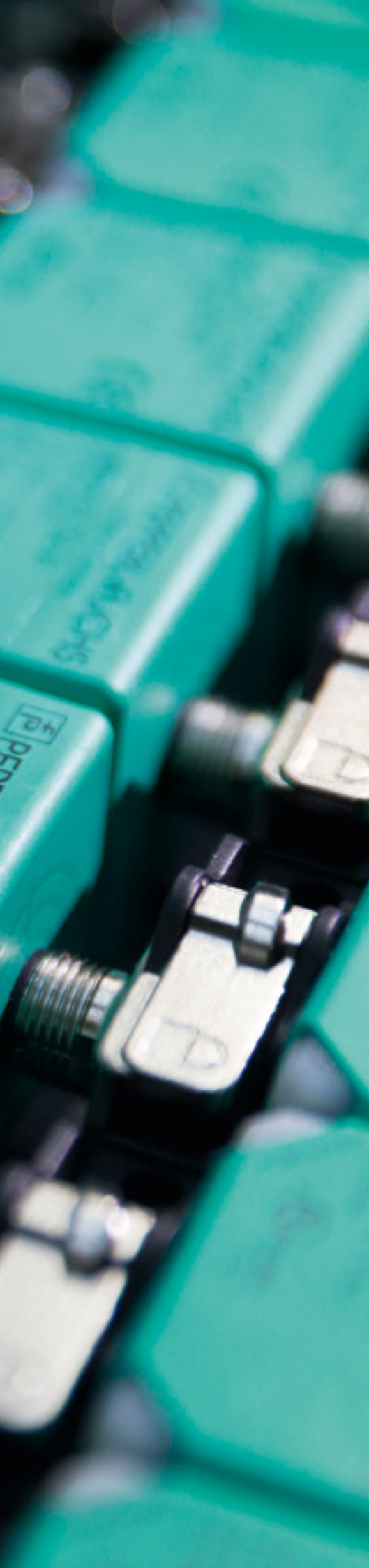

Standard Inductive Sensors

Perfectly Versatile, Suitable for Any Task

The application possibilities for inductive proximity sensors are virtually unlimited. Pepperl+Fuchs offers a portfolio that fulfills a host of requirements, with a wide range of designs, materials, and output signals with global approvals for a variety of technologies. Over 6,000 sensors make it easy to select the perfect sensor solution.



For more information, visit
[pepperl-fuchs.com/pf-proximity](https://www.pepperl-fuchs.com/pf-proximity)

A Portfolio That Covers Every Application

As the inventor of the proximity sensor, Pepperl+Fuchs continues to set standards for product quality and variety. Especially when it comes to cube-style standard inductive sensors, the company offers a vast range of designs for any kind of installation.









Reliable Technology, Global Approvals

Inductive proximity sensors are used wherever reliable, noncontact detection of metallic objects up to a distance of 100 mm is required. Pepperl+Fuchs' portfolio of cube-style standard sensors offers the widest variety of global approvals. This includes country- and industry-specific approvals such as DNV GL, UL, and CCC.

Sensors are available for all supply voltages (DC, AC, universal current) and output signals (analog, digital, and AS-Interface). A wide variety of designs and materials, combined with a complete range of cables and connectors, offers the right solution for every application.

Highlights

- Highest quality standards in sensor production ensure complete application reliability
- Portfolio guarantees the ideal sensor solution for every application
- Customer-specific adaptations tailored to individual applications
- Extreme ruggedness and durability, perfect for harsh industrial environments
- Expert customer consulting and technical know-how backed by in-house development and extensive market expertise

Selected technical data	F41 series	F79 series	F33 series	FP series	Varikont L2 series	Varikont series
						
Search term	N*-F41*	NBB1,5-F79-E*	NB*-F33*	N*-FP-*	NB*-L2*	NB*-U1*
Max. sensing range						
Flush	3 mm	1.5 mm	8 mm	40 mm	20 mm	20 mm
Non-flush			10 mm	50 mm	40 mm	40 mm
Output type	DC 3-/4-wire PNP/NPN	DC 3-wire PNP/NPN	DC 3-/4-wire PNP/NPN	DC 2-/3-/4-wire PNP, AC	DC 2-/3-/4-wire PNP, NPN	DC 2-/3-/4-wire PNP, NPN, AC, NAMUR
Electrical connection type	Cable, M8 plug connector	Cable	Cable	Terminal compartment, cable, M12 plug connector	Cable, M12 plug connector	Terminal compartment, cable, M12 plug connector
Housing material	Brass nickel-plated	PA plastic	PBT plastic/metal	PBT plastic/metal	PA plastic	PA plastic
Temperature range	-25 ... 70 °C	-25 ... 70 °C	-35 ... 70 °C	-25 ... 70 °C	-25 ... 85 °C	-25 ... 85 °C
Dimensions	8 × 8 × 55 mm	17,5 × 8 × 4 (4,7) mm	50 × 25 × 10 mm	80 × 80 × 40 mm	40 × 40 × 67 mm	40 × 40 × 118 mm

Error-Free, Rain or Shine

Pepperl+Fuchs standard inductive sensors do not just perform in traditional industrial applications. Their quality is unmistakable where ambient conditions are most demanding. Reliable, rugged, and extremely durable, they come into their own in outdoor applications with temperatures well below freezing.

Air Freight: Precise and Efficient Positioning

Air freight must be loaded reliably and efficiently to ensure the smooth flow of air traffic. To this end, cargo containers are transported from an interim storage location to loading points via conveyor elements. Two inductive sensors detect when a container has reached the required position. Transport is then stopped, and the air freight is ready for collection. As soon as the container is transported away, the ramp is reported as available, and new air freight can advance.

FP series inductive sensors are perfect for this task. They are rugged and unaffected by the movements and vibrations of heavy containers. They also have long sensing ranges for both flush and non-flush mounting, ensuring reliable and efficient processes.

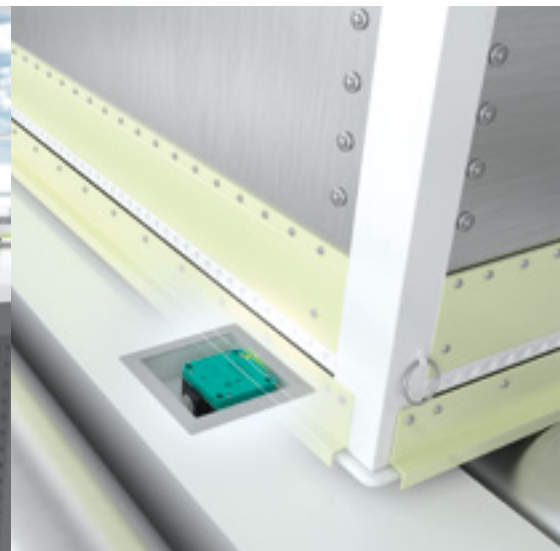
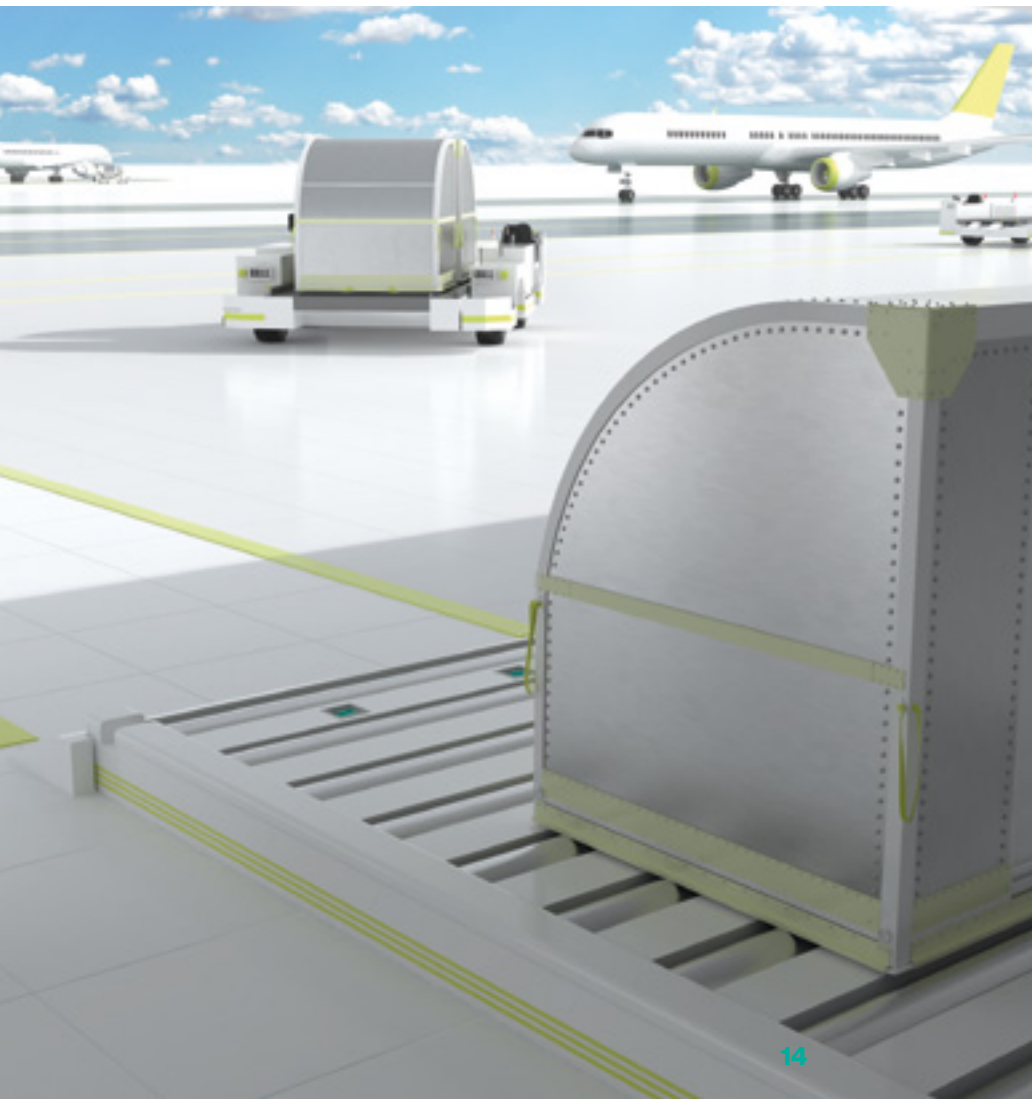

Transport: Getting Passengers to Their Destination Safely

Perfectly smooth and safe operation is not optional on gondola lifts in skiing and hiking areas. Sensors are installed around the entrance and exit areas of gondola stations. They detect the conveyor rollers of each cabin to ensure that speed and position are controlled precisely. The sensors also trigger the door opening and closing operations. Since temperatures can

drop well below freezing in winter, rugged Varikont L2 series sensors are ideal for outdoor applications like this. They have long sensing ranges, are easy to install, and offer absolute reliability.

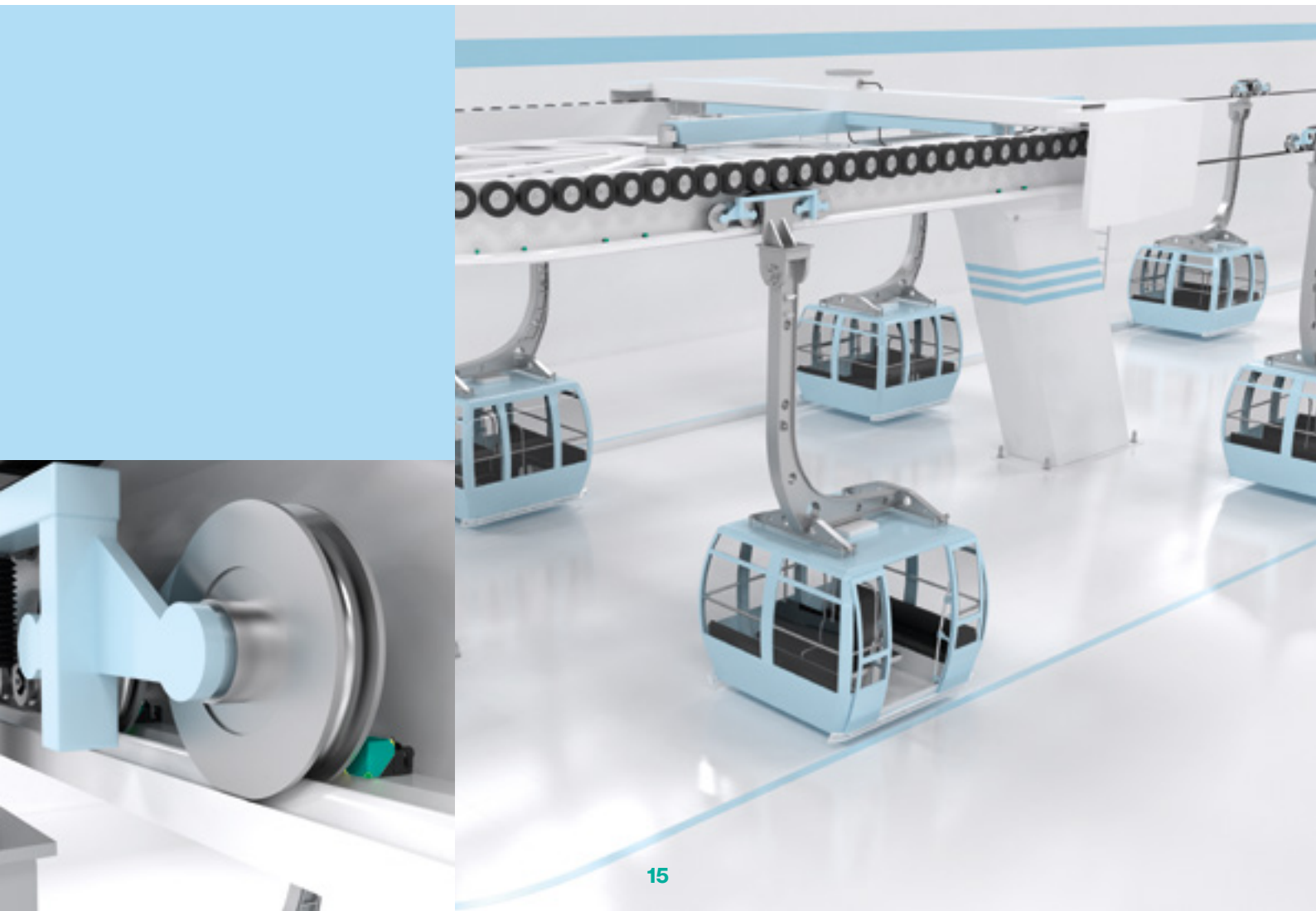

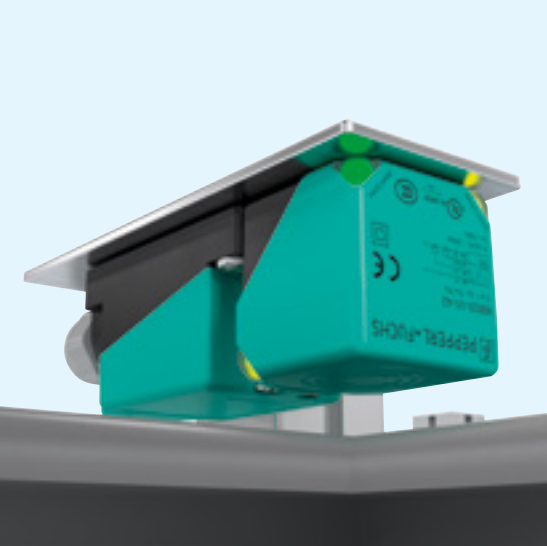
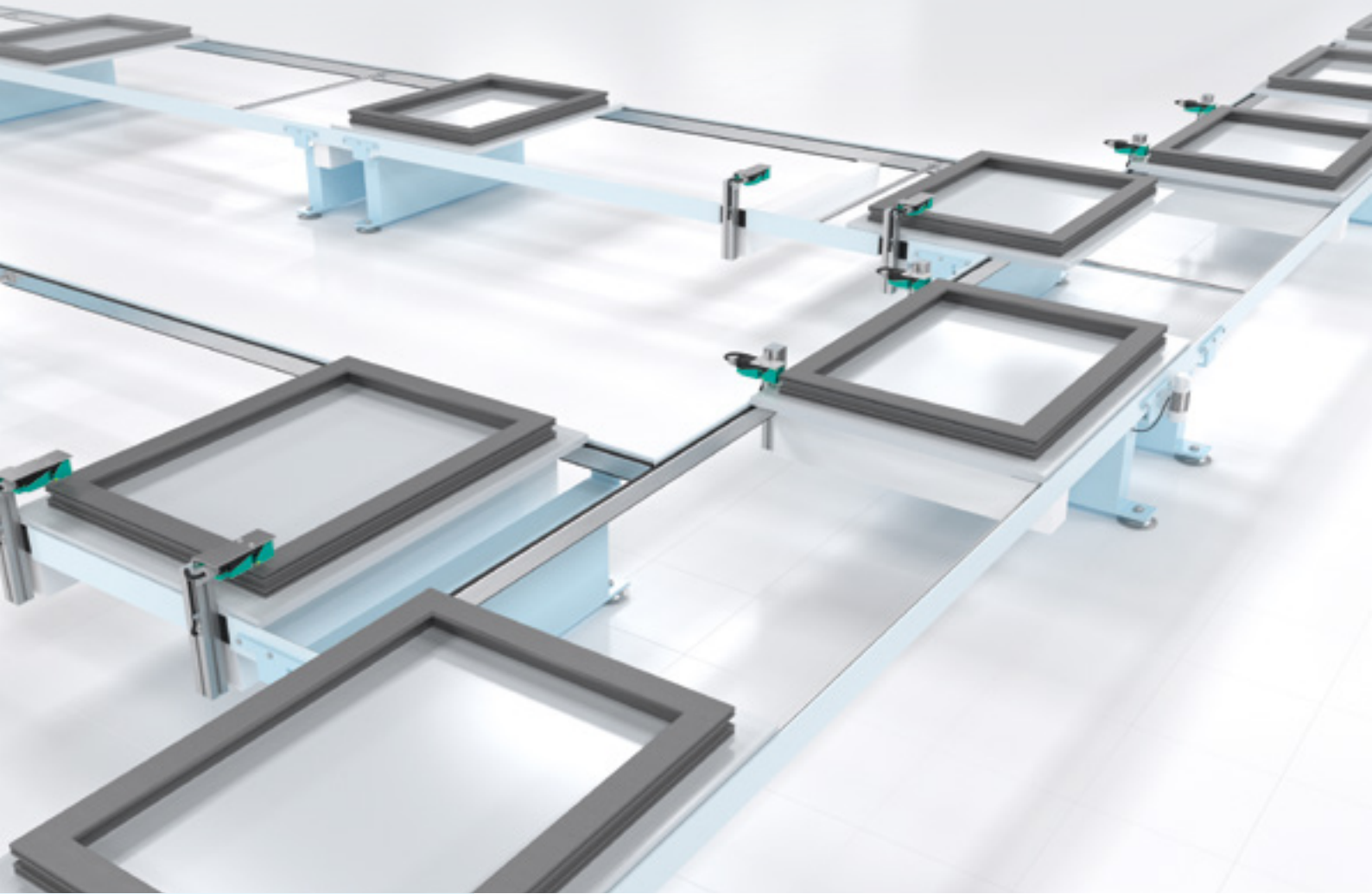

Window Frame Production: Optimizing Material Flow

To prevent damage and ensure efficient throughput times in window frame production, various production lines have to merge without collision. Frames traveling down each line must be detected and released at exactly the right time.

Varikont series sensors show their strength in this application. The devices can be easily and flexibly integrated into the conveyor lines, and their rotating sensor heads enable adjustment of the detection area. For easy status checks, the devices have four indicator LEDs that ensure 360° visibility.

Automotive Production: Ensuring Reliable Presence Detection

Metal sheet processing is a key application in the production of car body components. Gripper robots must be able to detect the presence of the sheets before they feed them into a press line. For this purpose, four Varikont L2 series sensors are installed on the robots' gripper mechanisms. If a panel is present, the grippers are activated. If no panel is present, the process is stopped immediately. The sensors' compact design and rotating head enable easy, flexible integration into the system.

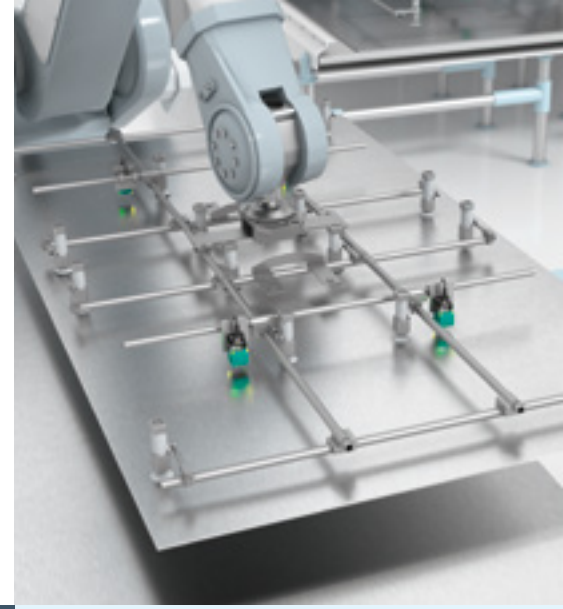

Varikont L2 Series Highlights

- LEDs with 360° visibility for status checks at any time
- Rotating sensor head provides flexibility
- Simple, tool-free mounting
- Sensor head can be rotated without tools—maximum flexibility when adjusting the sensor surface

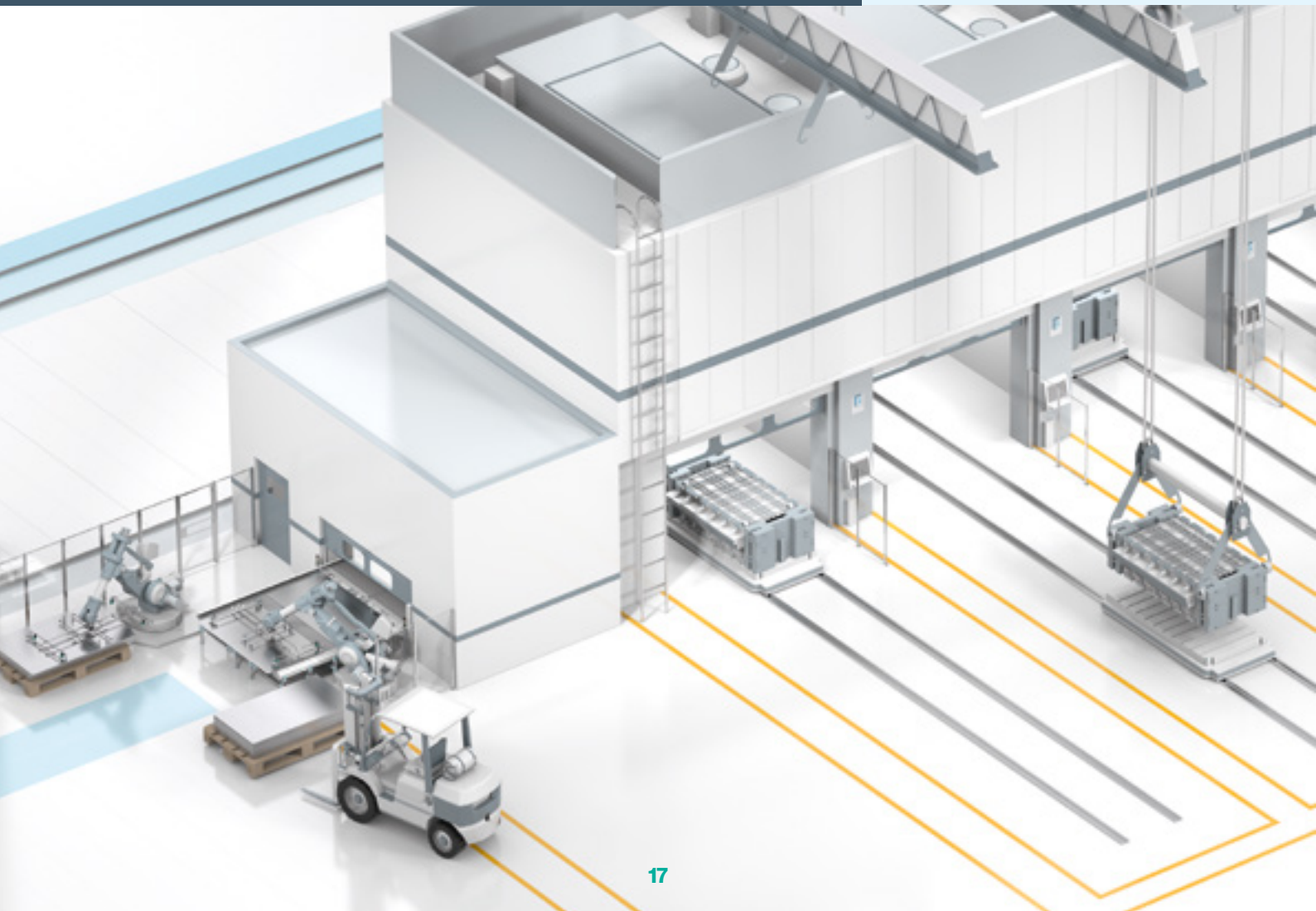

A Housing Design for Every Installation

With its enormous range of inductive proximity sensors, Pepperl+Fuchs can meet a multitude of customer requirements worldwide. No matter what size, connection type, or sensing range—the largest portfolio of cylindrical designs on the market offers a solution for each individual application.









Wide Variety of Standard Designs

In addition to cube-style housing designs, Pepperl+Fuchs also offers a broad portfolio of cylindrical standard sensors. These are used for position detection in machine tools and monitoring safe end positions, among many other applications. The sensors are available for all supply voltages (DC, AC, universal current) and output signals (analog, digital, and AS-Interface). A wide range of designs, materials, cables, and connectors means the right solution is available for every application. In addition, the devices offer necessary approvals, such as DNV GL, UL, and CCC.

For users looking to configure the ideal three- or four-wire sensor, a variety of options are available, all of which can be combined flexibly. These options include not only the diameter and length of the housing, but also the type of installation, the operating distance, and the type of connection.

Highlights

- Highest quality standards in sensor production ensure reliability
- Complete portfolio provides the optimal sensor solution for every application
- Customer-specific adaptations tailored to individual applications
- Extreme ruggedness and durability, perfect for use in harsh industrial environments
- Expert customer consulting and technical know-how backed by in-house development and extensive market expertise

Selected technical data	D3/M4 series	D4/M5 series	D6.5 series	M8 series	M12 series	M18 series	M30 series
							
Search term	NB*-3M22-* NB*-4GM22-*	NB*-4M25-* NB*-5GM25-*	N*-6,5*	N*-8G*	N*-12G*	N*-18G*	N*-30G*
Max. sensing range							
Flush	1 mm	1,5 mm	3 mm	3 mm	6 mm	12 mm	15 mm
Non-flush			6 mm	6 mm	10 mm	20 mm	40 mm
Output type	PNP, NPN, DC 2-/3-/4-wire						
Electrical connection type	Fixed cable	Fixed cable, M8 connector plug	Fixed cable, M8 × 1, M12 × 1 connector plug	Fixed cable, M8 × 1, M12 × 1 connector plug	Fixed cable, M8 × 1, M12 × 1 connector plug	Fixed cable, M12 × 1 connector plug	Fixed cable, M12 × 1 connector plug
Temperature range	-25 ... 70 °C	-25 ... 70 °C	-40 ... 85 °C	-40 ... 85 °C	-40 ... 85 °C	-40 ... 85 °C	-40 ... 85 °C
Dimensions	Ø 3 mm	Ø M5	Ø M6,5	Ø M8	Ø M12	Ø M18	Ø M30

Optimal Performance, Even under the Most Difficult Conditions

Whether for indoor applications, demanding use in chemical plants, or harsh conditions in automated car washes, Pepperl+Fuchs offers a broad portfolio of cylindrical standard sensors for every application.

Chemical Plants: Reliable Valve Position Monitoring

Linear valves are used to control the flow of all types of process media. They open or close the pipes that feed or discharge these substances. Inductive sensors detect the end position of the lifting rods to monitor whether the valve position is open or closed. A set of two proximity sensors can be used to provide the required redundancy for safety-critical applications.

This application is common throughout chemical plants, tank farms, and petrochemical plants. Since hazardous areas are par for the course in these industries, sensors with the relevant global approvals are available. The sensors can be used for any valve size, and their noncontact, wear-free technology ensures an extremely long service life.

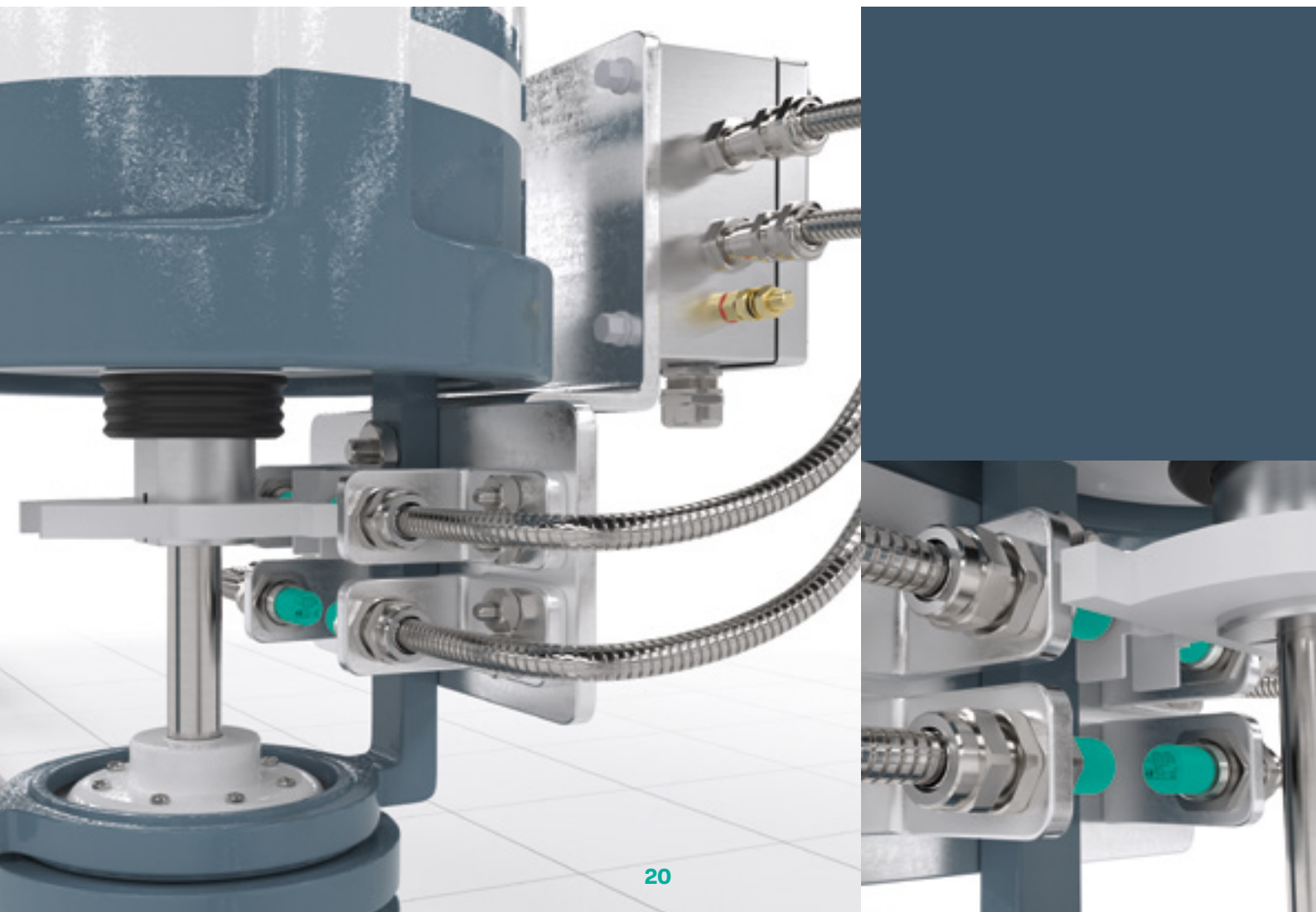

Wind Energy: Flexible and Cost-Effective Rotational Speed Measurement

Cylindrical inductive sensors perform important tasks during power generation in wind turbines. One example is ensuring that rotational speed in the huge turbines' gondolas. The sensors are also used in the rotor blade actuator area to ensure that the blades are properly aligned with the wind.

Inductive sensors not only offer a cost-effective detection option, they can also be installed anywhere due to the enormous variety of housing sizes and designs. The rugged sensor technology also ensures reliability, even under extreme operating conditions.

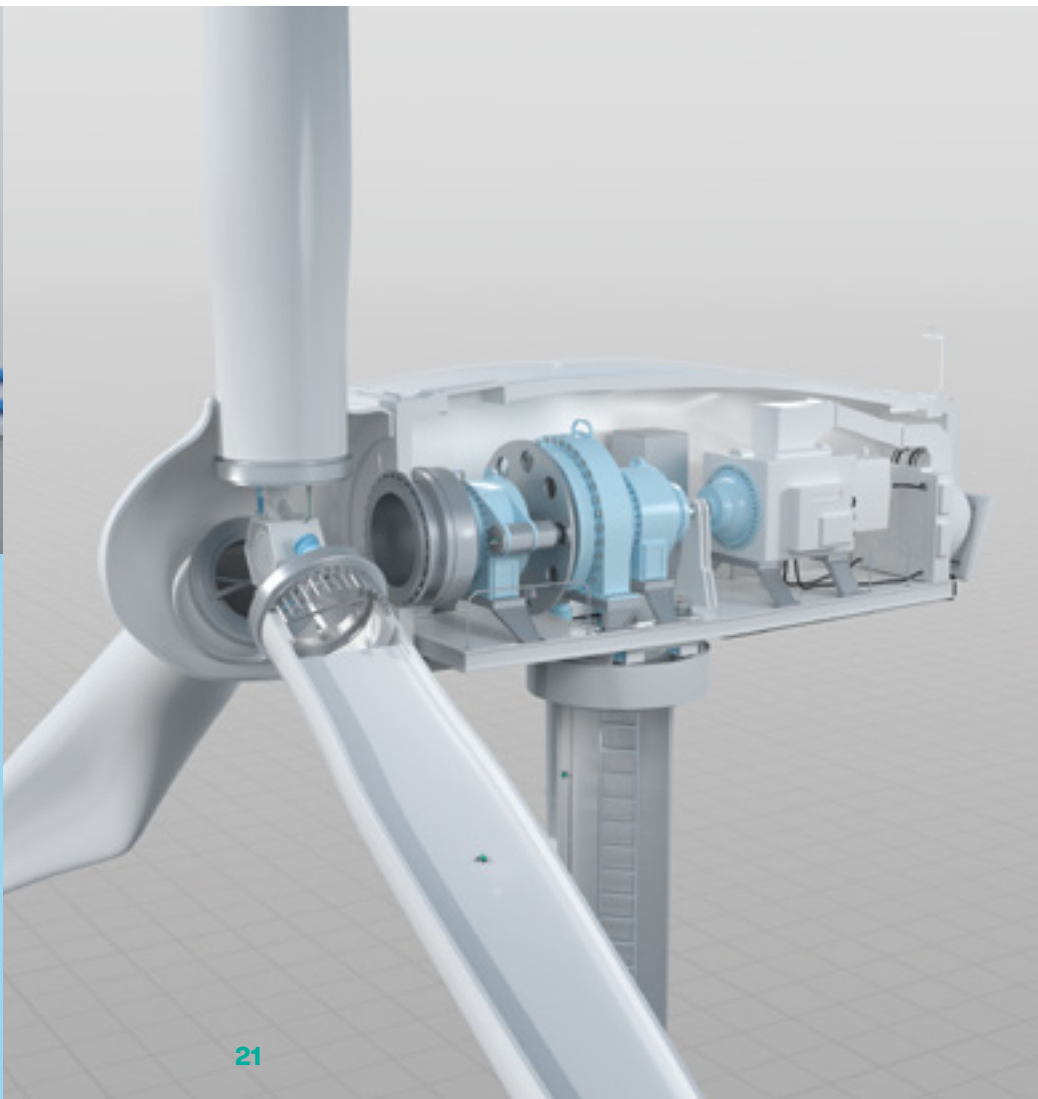
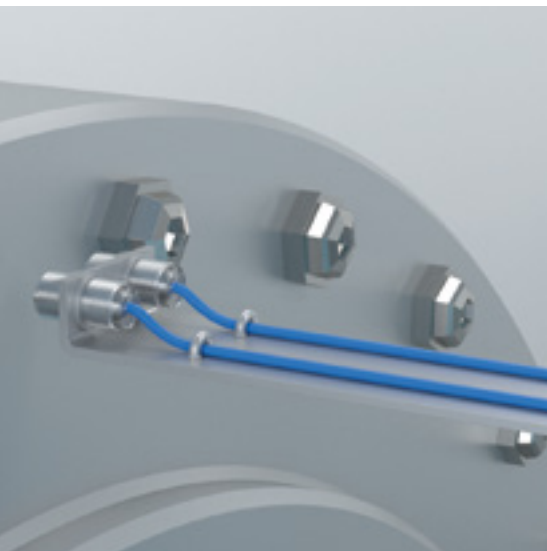

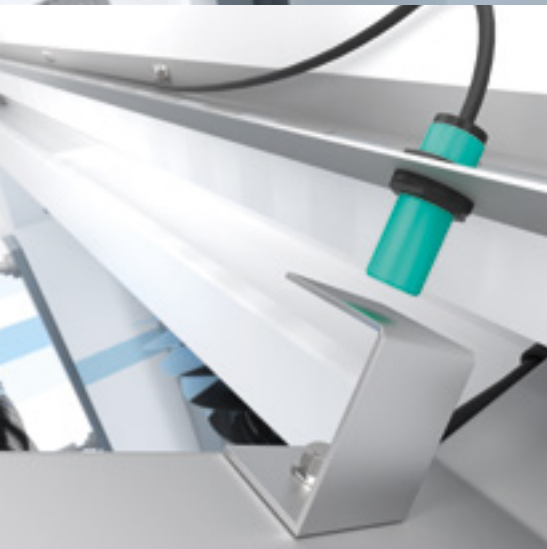
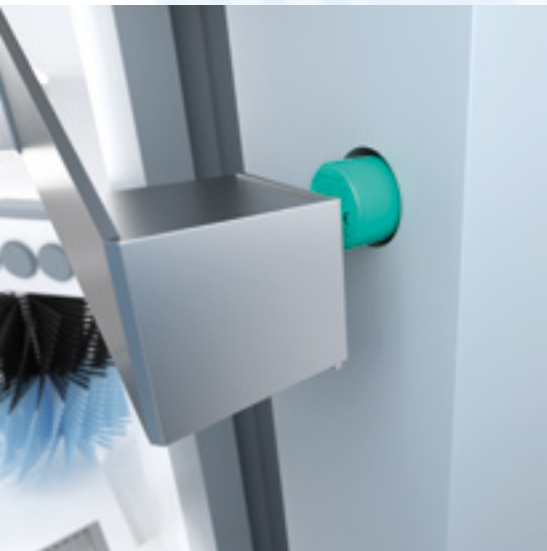
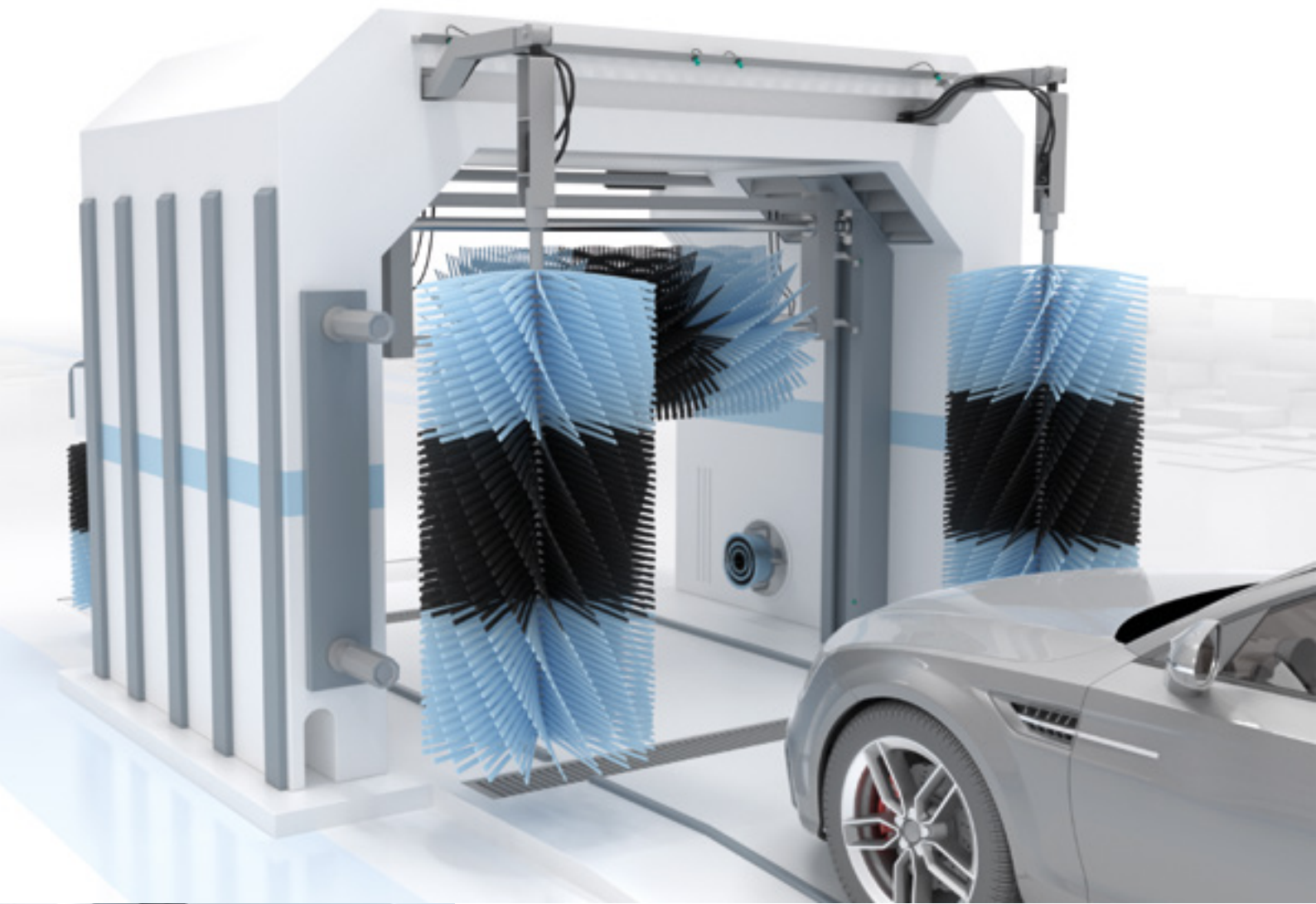

Car Washes: Rugged, Maintenance-Free Solutions

Inductive sensors are used to detect the end positions of vertical and horizontal brush holders and dryers in car washes. In such demanding settings, reliable and maintenance-free operation is essential. Sensors are not only exposed to constant moisture and cleaning chemicals, they also have to withstand extreme temperatures, depending on the season.

Rugged, chemically resistant plastic housings and special cables provide the durability needed. To withstand the constant movement of machine parts, the sensors are shock-resistant and have cables that are suitable for drag chains. With a special sealing concept, the sensors are ideal for use in IP68/ IP69K applications.

Bottling: Maintaining Control of High-Speed Processes

Standard inductive sensors are used in bottling plants to verify the presence of caps. Rejects have to be reliably detected early on, despite the high-speed filling process. The sensors' high switching frequencies ensure reliable object detection and high quality standards amid rapid process flows. In addition, high IP ratings enable easy and cost-effective cleaning.

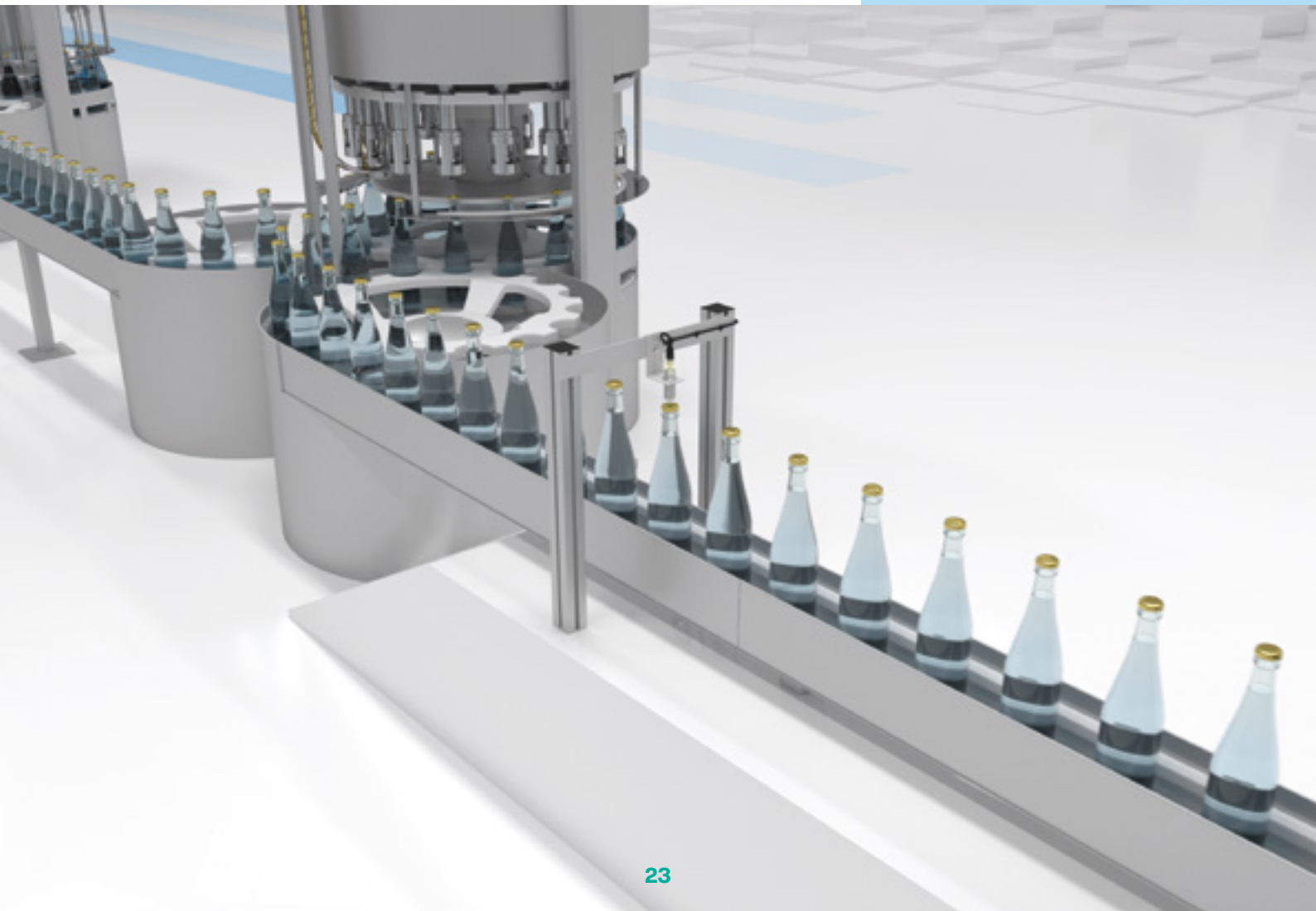

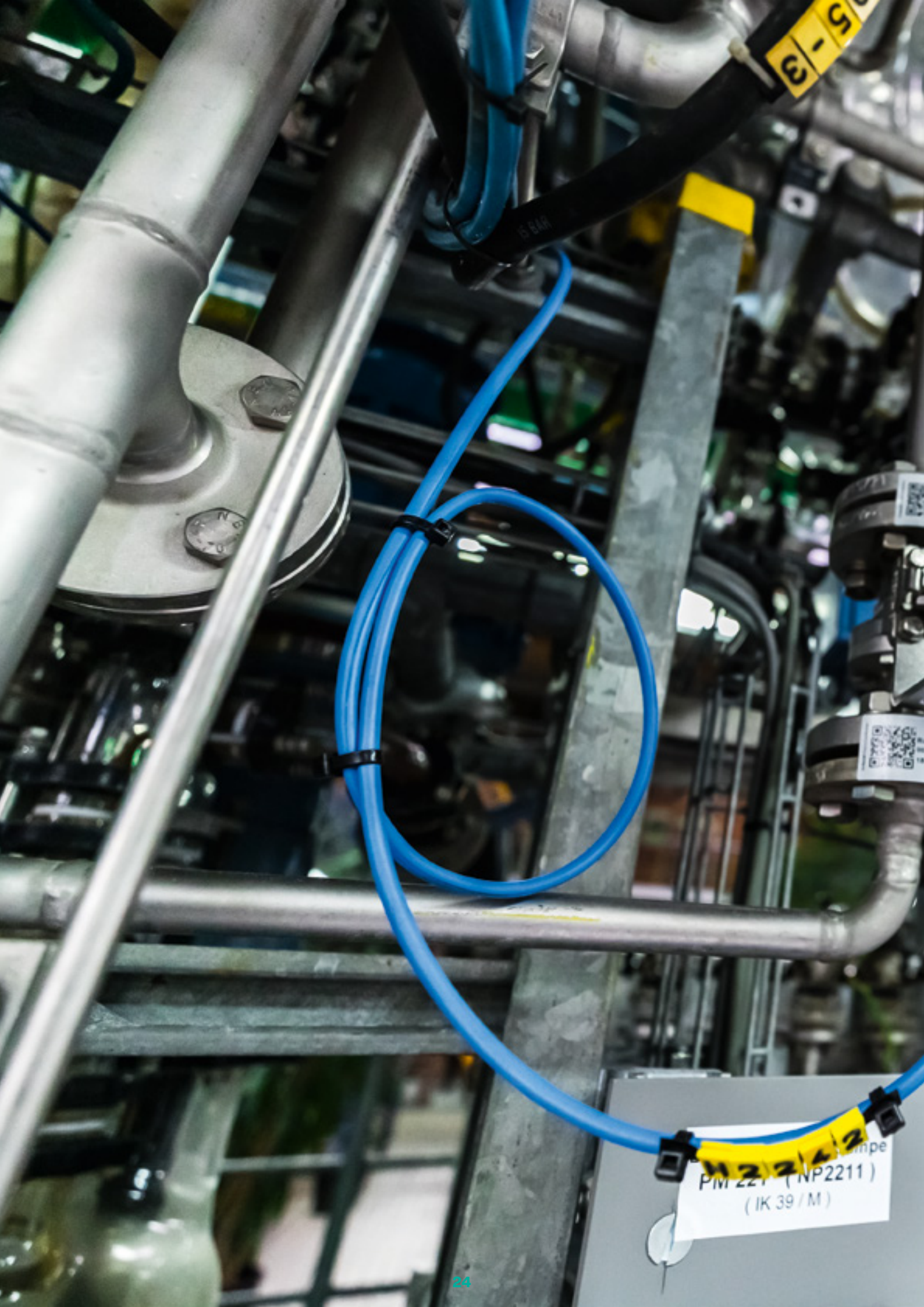

5-3

PM 221 (NP2211)
(IK 39 / M)



Inductive Sensors for Specific Requirements

Specialized for the Demands of Any Industry

Inductive sensors are used in virtually every industry, and the requirements they have to meet are as diverse as the application areas they are used in. The automotive industry demands sensors that can handle high temperatures and magnetic fields, while sensors with increased pressure resistance are required in construction machinery. Pepperl+Fuchs offers a range of highly specialized sensors that meet every challenge and are suited to any environmental condition.



For more information, visit
pepperl-fuchs.com/pf-proximity

Special Designs for Special Tasks

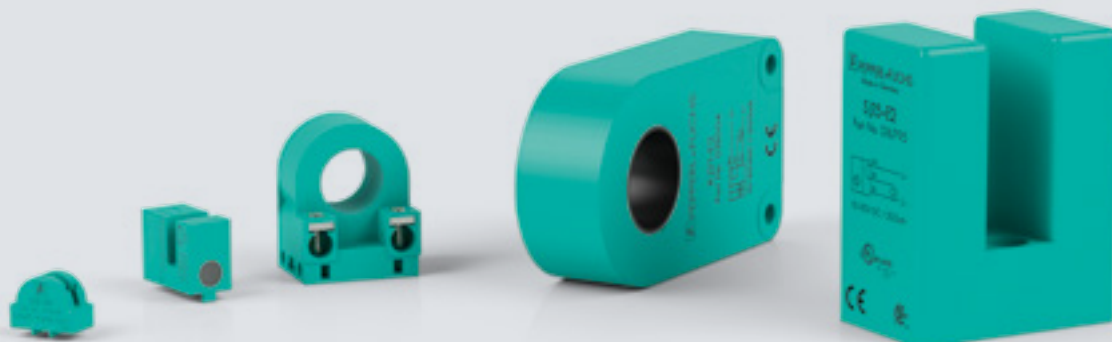

Slot and Ring Sensors, Adapted to Specific Installation Conditions

Sensors with a special housing design are required for unique application requirements. Ring sensors, for example, are equipped with a circular coil to detect the flow of materials through a ring. As soon as a metallic object is inside this ring, the sensor is activated. These sensors are typically used to detect and count small metal parts.

Special designs also include inductive slot sensors, which consist of two opposing coil systems. They are used to detect a target between the slot walls of the sensor and are ideal for pointer monitoring in flowmeters, among other applications.

Slot Sensor Highlights

- Compact design for a wide range of applications
- Meet functional safety criteria (SIL 2/SIL 3) according to IEC 61508
- LED for visual function verification

Ring Sensor Highlights

- 10 mm and 15 mm diameter for applications in flow transmitters
- Highly reliable NAMUR electronics

Selected technical data	RC series	RJ series	SJ2 series	SJ15 series	SJ15 series
					
Search term	RC*-14-N*	RJ*-*	SJ*-*N*	SJ*-E*	SJ*-A*
Ring Diameter	10 mm, 15 mm	15 mm, 21 mm, 43 mm	–	–	–
Slot width	–	–	2 mm, 3,5 mm, 5 mm, 10 mm, 30 mm	10 mm, 15 mm	15 mm, 30 mm
Temperature range	-20 ... 100 °C -25 ... 70 °C	-25 ... 70 °C	-25 ... 100 °C -50 ... 100 °C	-25 ... 70 °C	-25 ... 70 °C
Output type	NAMUR NAMUR, bistable	NAMUR 3-wire PNP, NO contact	NAMUR Safety NAMUR	3-wire PNP 3-wire NPN	4-wire PNP, antivalent 4-wire NPN, antivalent
Approvals	ATEX, cULus	ATEX, cULus	cULus, SIL 2/3, ATEX, IECEx, cULus-hazardous location and more	cULus	cULus



Limit Detection on Flowmeters: NAMUR Ring Sensors

Pepperl+Fuchs offers special ring sensors for determining the limit values in glass cone variable area flowmeters. The sensors are available with internal diameters of 10 mm and 15 mm, and their sensitivity is designed for common damping bodies. The limit value signal is absolutely reliable in monostable or bistable operation. The bistable sensors detect whether the float is above or below a sensor. They can be operated with standard NAMUR amplifiers and do not require a separate control unit.



Reliable and Resistant



Magnetic-Field and Weld-Spark Resistant

Weld-proof sensors rated up to IP68 are the ideal detection solution in welding areas and other harsh operating environments. Designed with two coupled air-core coils, they are resistant to magnetic fields, such as those that can arise from electric welding or frequency converters. The sensor electronics also ensure immunity to EMC interference. The housing designs ensure durability and availability. PTFE-coated brass sleeves on the cylindrical sensors ensure they are as well protected against welding sparks and metal chips as the cube-style versions made of metal and special weld-proof plastic.

Highlights

- High magnetic-field resistance ensures reliable sensing
- Extreme durability: rugged housing designs (IP67 and IP68) with PTFE coating or weld-proof plastic
- Available with IO-Link
- Many years of experience in the selection and integration of sensors

Selected technical data	M12 series	M18 series	M30 series	F104M series	Varikont series	FP series
						
Search term	N*-12GM*-C	N*-18GM*-C	N*-30GM*-C	NMB6-F104M-E*-C	N*-L3*-C	N*-FP*-C
Max. sensing range						
Flush	4 mm	12 mm	15 mm	6 mm	20 mm	50 mm
Non-flush	10 mm	15 mm	30 mm		40 mm	75 mm
Output type	2-/3-/4-wire PNP, IO-Link			DC 3-wire PNP/NPN	AC, DC 3-/4-wire PNP/NPN, IO-Link	DC 3-/4-wire PNP
Housing material	Brass, PTFE coated			Stainless steel 1.4305/ AISI 303, coated	PA6 plastic/metal, coated	PBT plastic/metal, coated
Temperature range	-25 ... 70 °C	-25 ... 70 °C	-25 ... 70 °C	-25 ... 70 °C	-25 ... 85 °C	-25 ... 70 °C
Dimensions	Ø M12	Ø M18	Ø M30	32 × 20 × 8 mm	40 × 40 × 67 mm	80 × 80 × 40 mm

Weld-proof sensors are available in standard, reduction factor 1, and metal face versions.

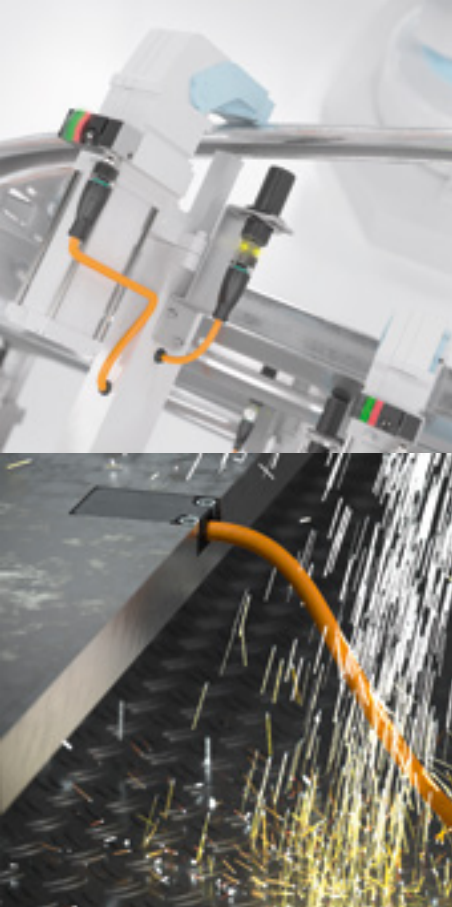

Automotive Industry: Connectivity on Welding Robots

When car body parts are welded, the sensors and cables used need to be resistant to magnetic fields and flying sparks. To ensure fault-free operation, Pepperl+Fuchs offers POC and PUR cables that provide optimal connectivity, even in the immediate vicinity of welding operations. The cables withstand extreme mechanical loads and are resistant to welding beads, temperatures up to 150 °C, as well as oil and chemicals.

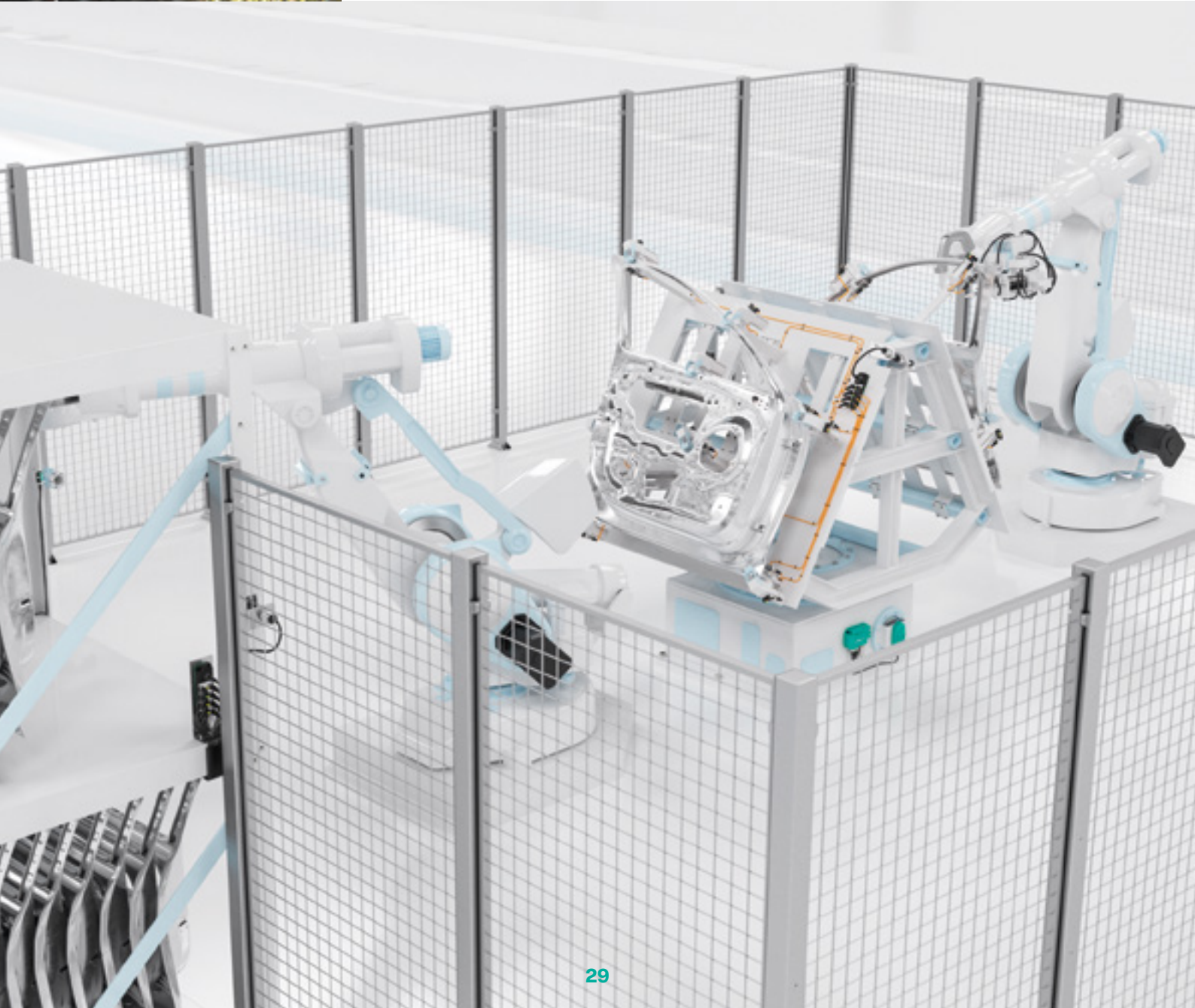



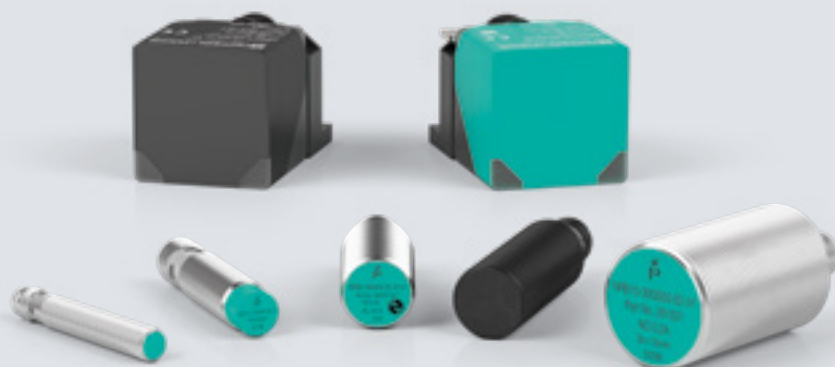

Highly Adaptable, Regardless of Metal Type



Flexible and Reliable in All Areas

Pepperl+Fuchs' broad portfolio of reduction factor 1 sensors enables flexible machine and plant design, with industry-standard cylindrical and cube-style designs, different cable versions, versions with IO-Link, and weld-proof and chemically resistant special sensors for harsh operating conditions. Customer- and application-specific adaptations offer users the benefit of Pepperl+Fuchs' technical know-how and decades of experience as inductive sensor technology pioneers.

Selected technical data	M8 series	M12 series	M18 series	M30 series	Varikont series	FP series
						
Search term	NR*-8G	NR*-12G	NR*-18G	NR*-30G	NR*-L3*	NR*-FP
Max. sensing range						
Flush	2 mm	4 mm	8/12 mm	15 mm	20 mm	50 mm
Non-flush	6 mm	10 mm	15 mm	30 mm	35/40 mm	70 mm
Switching frequency						
Flush	4000 Hz	2400 Hz	1400 Hz	750 Hz	100 Hz	80 Hz
Non-flush	2500 Hz	1500 Hz	600 Hz	300 Hz	100 Hz	75 Hz
Output type	3-wire PNP NO contact	3-wire PNP, NPN NO, NC 4-wire PNP, NPN, antivalent, IO-Link				3-wire PNP NO contact, 4-wire PNP, antivalent
Housing material	Stainless steel V2A, LCP Brass, PTFE-coated, LCP		Stainless steel V2A, PBT Stainless steel V4A, LCP Brass, PTFE-coated, PPS		GD-ZnAl4Cu1-coated, PA 6 Grivory	PBT/metal, PTFE-coated
Dimensions	Threaded sleeve M8 x 1 Smooth sleeve 6.5 mm	Threaded sleeve M12 x 1	Threaded sleeve M18 x 1	Threaded sleeve M30 x 1.5	40 x 40 x 40 mm (Varikont L) 40 x 40 x 120 mm (Varikont)	80 x 80 x 40 mm

Standard, IO-Link, and weld-resistant versions available.

Ideal for Applications with Variable Objects

Starting with steel, the sensing ranges of conventional inductive sensors fall by a certain reduction factor from metal to metal. This is not the case with reduction factor 1 sensors. They offer identical sensing ranges for all metals with a single sensor. This enables more flexible machine design and use in applications with variable objects. Using a single sensor instead of multiple sensors reduces procurement, storage, and administrative costs. In addition, reduction factor 1 sensors offer high resistance to magnetic fields arising from welding fields and frequency converters.

Highlights

- Complete solution from a single source: comprehensive IO-Link portfolio of standard and special sensors, as well as associated infrastructure
- Predictive maintenance with IO-Link features such as stability alarm and temperature indicator
- Wide range of sensors for material-independent detection of metallic objects with identical sensing range
- Highly rugged and weld-proof sensors rated up to IP68/IP69K for use in harsh industrial environments

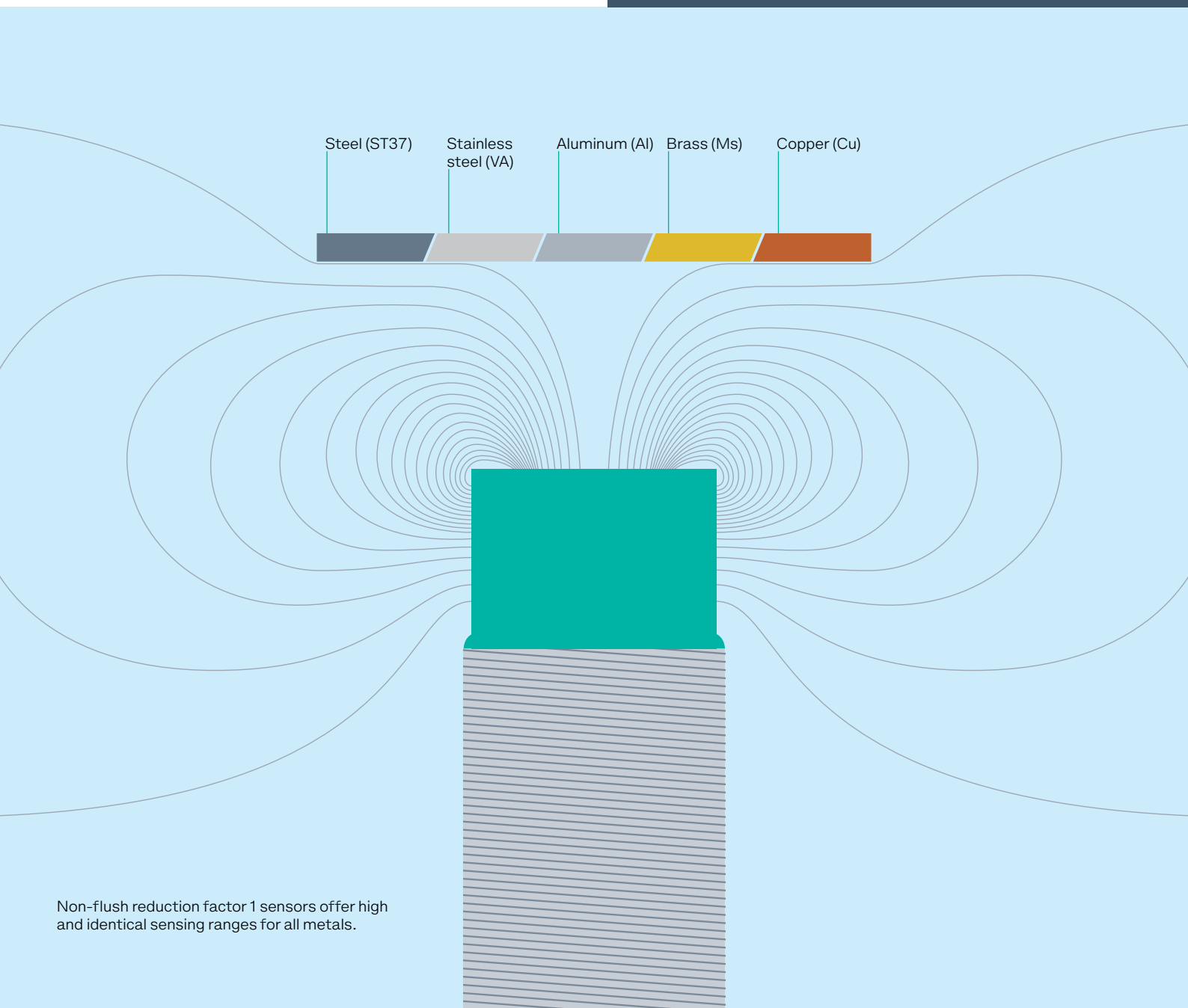

Non-flush reduction factor 1 sensors offer high and identical sensing ranges for all metals.

Perfect for Harsh Conditions



Resistant to Heavy Loads and Forces

In extremely harsh industrial environments, inductive sensors are often exposed to mechanical stress that can shorten their life cycle. For example, when used in machine tools, high forces, abrasion, and aggressive chemicals take a toll on sensors. For such applications, Pepperl+Fuchs offers metal face sensors that feature a self-contained stainless-steel housing with a metal sensing face.

Highlights

- Resistant to harsh ambient conditions such as humidity and mechanical shock
- A self-contained, stainless-steel housing with metal sensing face ensures corrosion resistance, impermeability, pressure resistance, wear resistance, durability, reliability, and increased plant availability
- C-series metal face sensors are resistant to weld spatter
- Extended sensing range

Selected technical data

	F104M series	8GM series	12GM series	18GM series
Search term	NMB6-F104M-E*	NMB3-8GM*	NMB5-12GM*	NMB10-18GM*
Max. sensing range Flush	6 mm	3 mm	5 mm	10 mm
Output type	DC 3-wire PNP/NPN			
Housing material	Stainless steel 1.4305/AISI 303			
Dimensions	32 × 20 × 8 mm	Ø M8	Ø M12	Ø M18



Metal Forming: Reliable Detection of Fault States

In metal forming, panels are fed into a cutting die in a press. The die pierces through the material to produce the desired contours. By means of spring force, a stripper plate prevents the metal panel from getting stuck in the cutting die when the press opens. If this stripper plate does not return to the home position after the die-cutting operation, a metal panel could still be in the mold cavity. The process must be stopped immediately to prevent downtime and costly damage to the die. Metal face sensors provide reliable detection despite contact and shocks.

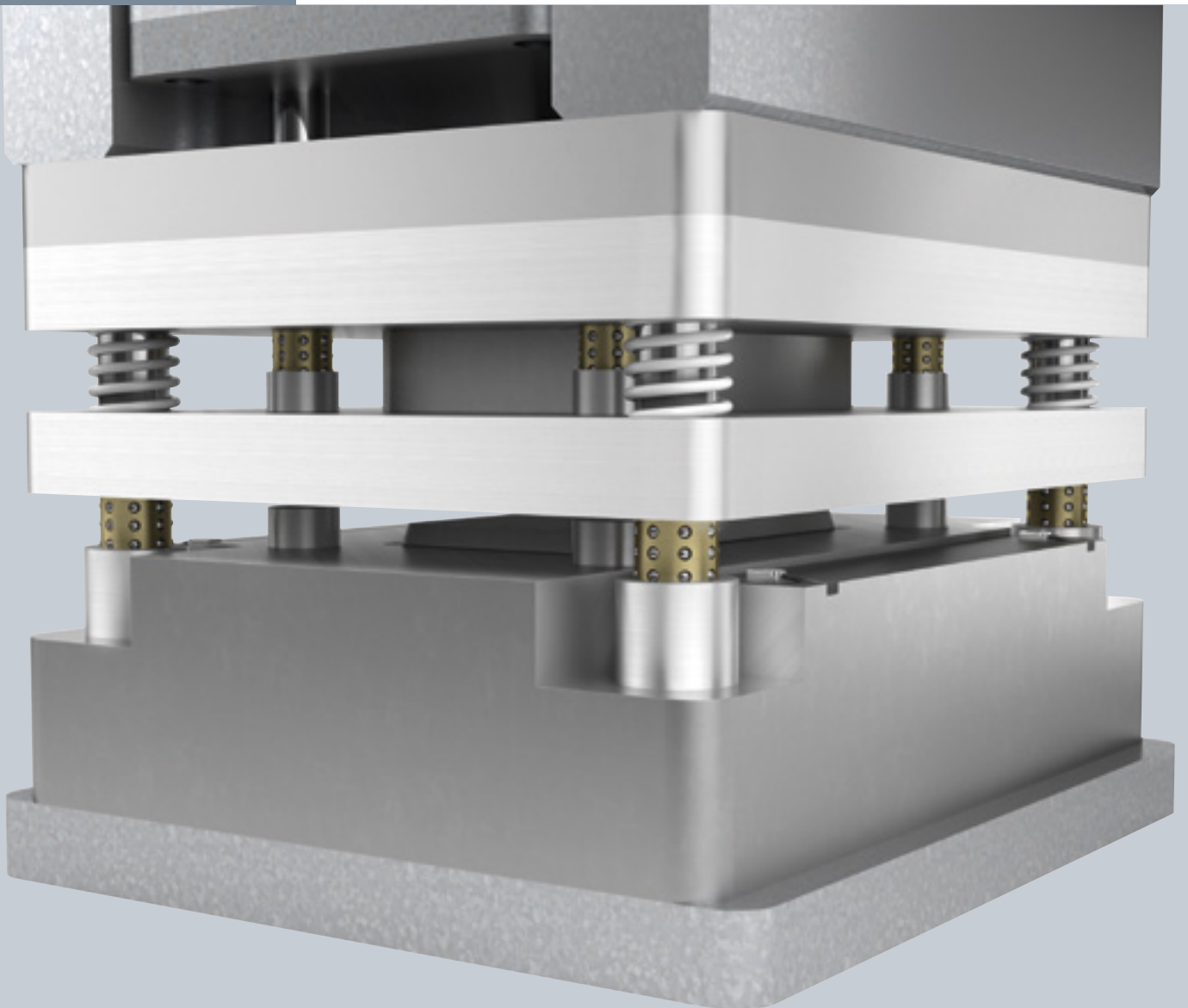

Effective under Pressure

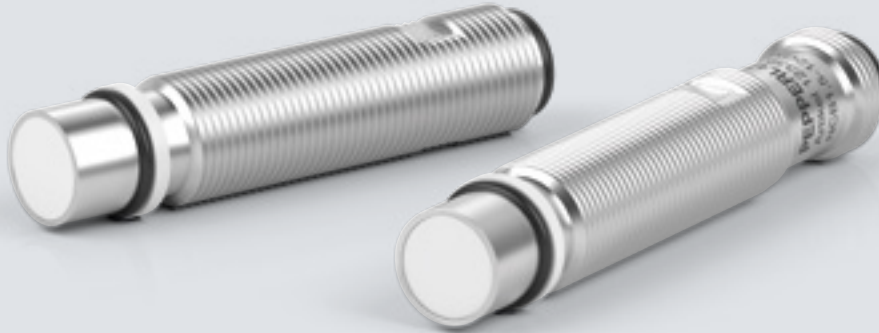

Rugged and Resilient

Pressure-resistant inductive sensors are typically used to detect components in applications that involve high hydraulic and pneumatic pressures—such as end position detection of pistons. The required pressure resistance is achieved by means of a ceramic sensing face that is embedded in a stainless-steel housing (which enables flush mounting).

Pepperl+Fuchs offers several sensors that are designed to withstand operating pressures of up to 500 bar and pressure peaks of up to 1,000 bar. In addition, the portfolio offers models with different sensing ranges, designs, and output and connection options to ensure optimal solutions.

Highlights

- Extremely rugged design for pressures up to 1,000 bar
- Optimized portfolio—tailored to applications in hydraulic and pneumatic cylinders
- Different sensing ranges and output and connection options ensure optimal solutions

Selected technical data

12GM series



18GM series



	12GM series	18GM series
Search term	NCB1,5-12GM*	N*-18GM*-D
Max. sensing range		
Flush	1.5 mm	1.5 mm
Output type	PNP, DC 3-wire	PNP, NAMUR
Electrical connection type	M12 × 1 connector plug	M12 × 1 connector plug, fixed cable
Housing material	Stainless steel 1.4305/AISI 303 (V2A)	
Temperature range	-25 ... 100 °C	-25 ... 85 °C -35 ... 80 °C (NAMUR)
Dimensions	Ø M12	Ø M18

Hydraulic Applications: Reliable, Even under High Pressure

Pressure-resistant sensors are found in the pneumatic controls of production lines, cylinders in truck tilting devices, and hydraulic cylinders on excavator arms. To precisely control such machines and identify critical operating states, it is crucial to reliably detect defined piston positions at all times. For this purpose, sensors are screwed directly into the cylinder housing and detect the piston rod or piston itself. The active surface of the proximity sensor is in direct contact with hydraulic oil and is subject to the full pressure of the system, with peaks of up to 1,000 bar. Only extremely resistant sensors can be used in such applications. Equally important are quick mounting and the reliability of measured values.



Optimized for High Temperatures in the Automotive Industry

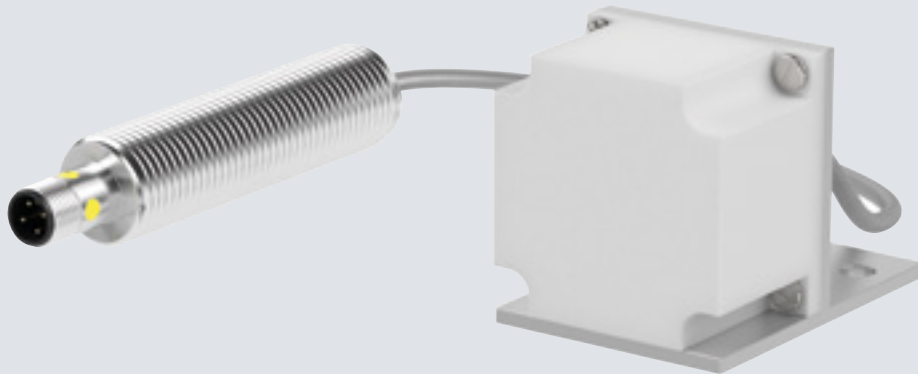

Easy to Integrate, Maximum Reliability

F35 series high temperature sensors were specially developed for use in temperatures up to 250 degrees Celcius. They consist of a sensor head and remote electronics. Both components are connected via a specially developed cable that meets the challenging requirements. The slim design of the control interface in the M18 housing with an M12 plug connector means it can be easily integrated—It can be mounted in a suitable location outside the hot zone, while the sensor is located inside the hot zone.

The portfolio of high temperature sensors includes models with different cable lengths that are adapted to the respective application. A further advantage is the fact that the sensing range is already calibrated in the hot zone. This eliminates a work step and makes commissioning much more straightforward and cost-effective.

Highlights

- Established and proven solution for applications in the automotive industry
- Reliable at high temperatures up to 250 °C
- Quick and easy commissioning thanks to sensor calibration in high temperatures
- Easy-to-integrate sensor structure with an extremely slim control interface

Selected technical data

F35 Series

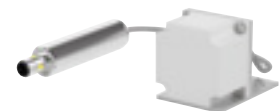

Search term	N*-F35*
Max. sensing range	25 mm
Flush	
Output type	PNP
Housing material	PTFE/Al/1.4305/AISI 303 (V2A)
Electrical connection type	M12 x 1 connector plug
Temperature range	0 ... 250 °C
Dimensions	56 × 40 × 40 mm, Ø M18 × 1 × 85 mm

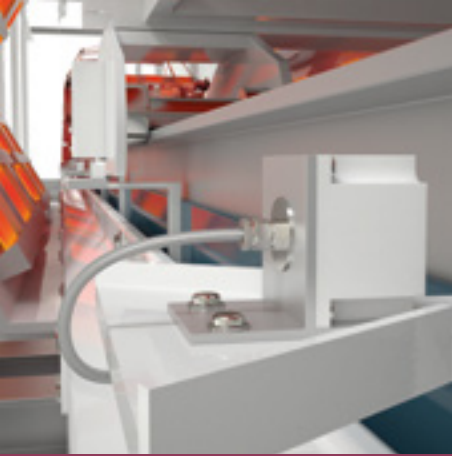

Automotive Industry: Continuous Use in High Temperatures

High temperature sensors have been relied on in automotive applications for many years. Their main field of application is in drying ovens. At the transfer points between conveyor systems in the oven, sensors detect skids and confirm their entry. The speed of the skids can likewise be controlled by the frequent signals from the sensors.



A New Chapter in Safety

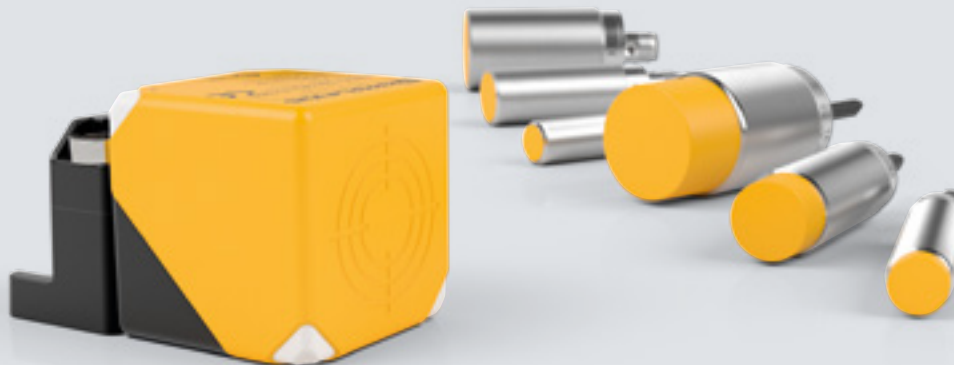

Intelligent Technology, Simple Operation

Pepperl+Fuchs inductive safety sensors come with SIL 2 functional safety and PL d Machinery Directive approvals. With redundant implementation, even SIL 3/PL e can be achieved. High characteristic safety values enable easy integration into the safety loop and prolong operating intervals. With intelligent electronics, the sensors do not have a dead band. This means that no minimum distance needs to be maintained between the sensor and the target. Simple standard metal targets can be used for detection; no special coding is required. A standardized OSSD interface and comprehensive safety documentation ensure quick and easy integration of the new safety sensors.

Highlights

- OSSD interface for direct connection to the safety control or I/O module
- Use of standard metal actuators with no dead band in front of the sensor—no adjustment required
- Ideal for demanding applications with extended temperature range and E1 approval
- High safety values for reduced inspection intervals and easier integration into the safety loop

Selected technical data	12GM/GH series	18GM/GH series	30GM/GH series	Varikont L2M series
				
Search term	NS*-12G*	NS*-18G*	NS*-30G*	NS*-L2M*
Max. sensing range				
Flush	2 mm	5 mm	10 mm	15 mm
Non-flush	4 mm	8 mm	15 mm	20 mm
Output type	DC, OSSD			
Connection	M12, cable connection			M12
Temperature range	-20 ... 70 °C, -40 ... 85 °C (M1)			-20 ... 70 °C
Approvals	PL d/SIL 2 (red. PL e/SIL 3), CE, UL, E1			PL d/SIL 2 (red. PL e/SIL 3), CE, UL
Housing material	Brass, stainless steel (V4A)			Plastic (PA)
Dimensions	Ø M12	Ø M18	Ø M30	40 × 40 × 40 mm

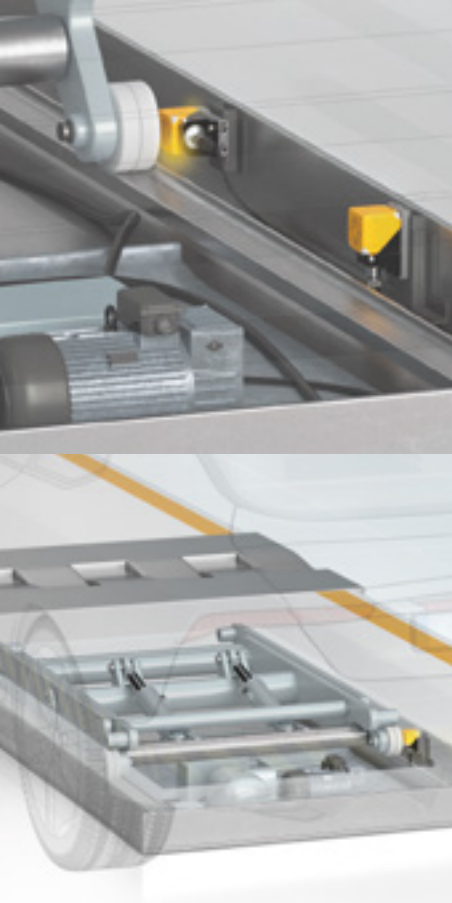

Automotive Industry: Reliable End Position Detection

In production environments, the protection of people and machines is the top priority—this is precisely where the Pepperl+Fuchs safety sensors are used. They ensure that welding operations can only be carried out when the protective doors of the welding cells are closed. On scissor lift tables in production lines, they ensure reliable end position detection in accordance with SIL 2/PL d. As soon as the table is extended, the sensors check that the correct end position has been reached.



High-End Components for Hazardous Areas

As a technology leader in explosion protection, Pepperl+Fuchs is known for its many years of experience and in-depth application know-how—a comprehensive portfolio of components testifies to this. In addition to intrinsically safe NAMUR sensors and interface modules, numerous proximity sensors with relevant certification are also available.









Advanced Sensor Technology for Demanding Tasks

Ever since inventing the proximity sensor, Pepperl+Fuchs has continuously developed and perfected the technology. The result is a comprehensive range of sensors in all designs and housing materials with a wide variety of detection ranges. With high degrees of protection, extended temperature ranges, or extreme pressure resistance, they are ideally suited for demanding applications in hazardous areas. Valve position detection and limit value monitoring are typical applications. With the widest-ranging expertise on the market and a complete portfolio, Pepperl+Fuchs can always offer an optimal solution for these application requirements and more.

Highlights

- Cylindrical sensors with diameters from 4.5 mm to 30 mm
- Slot sensors with a slot width from 2 mm to 30 mm
- Cube-style sensors with sensing ranges from 1.5 mm to 50 mm

Selected technical data	12GM/GK series	18GM/GK series	30GM/GK series	V3 series	L2 series	Varikont series	FP series
							
Search term	N*-12G*-*N*	N*-18G*-*N*	N*-30G*-*N*	N*-V3-N*	N*-L2-N*	N*0-U*-*N*	N*-FP-*N*
Max. sensing range							
Flush	2 ... 4 mm	5 ... 8 mm	4 ... 15 mm	3 mm	20 mm	20 mm	40 mm
Non-flush	4 mm	8 mm	15 mm	4 mm	40 mm	40 mm	50 mm
Temperature range	-50 ... 100 °C	-40 ... 150 °C	0 ... 200 °C -25 ... 150 °C -50 ... 100 °C	-25 ... 100 °C		-40 ... 100 °C	
Output type	NAMUR, Safety NAMUR			NAMUR		NAMUR, Safety NAMUR	
Housing material	Stainless steel V2A, PBT plastic			PBT plastic	PA plastic	PA plastic or PBT	PBT plastic, optionally with metal base
Approvals	cULus, SIL 2/3, ATEX, IECEx, cULus-hazardous location, and more			cULus, SIL 2, ATEX, IECEx, cULus-hazardous location, and more		cULus, SIL 2/3, ATEX, IECEx, cULus-hazardous location, and more	

Sensors for Hazardous Areas

Reliable Monitoring, Even under Extreme Conditions

In the oil and gas industry, sensor solutions are exposed to enormous loads in hazardous areas. For these extreme application requirements, Pepperl+Fuchs offers highly specialized proximity sensors that meet the strictest safety criteria and the highest requirements for ruggedness and durability.



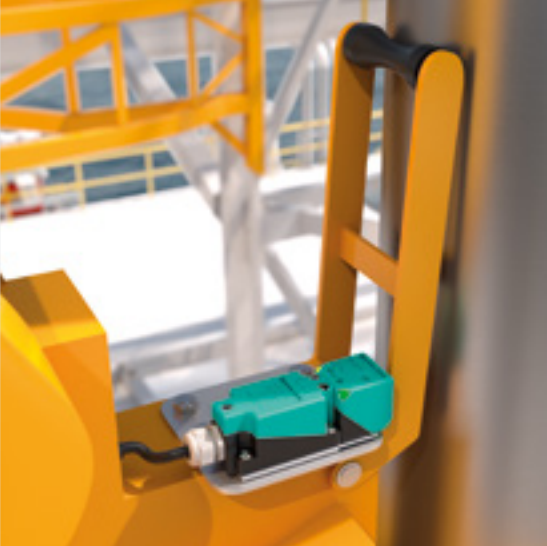

Oil and Gas Industry: Presence Monitoring

Oil production on offshore platforms does not just place great demands on people. The technology used there is also exposed to extreme weather conditions, corrosive atmospheres, and massive vibration. Since extraction is carried out at depths of up to several thousand meters, various drill pipes are required. A pipe handler transports the pipes from the interim storage location to the drilling device. An inductive sensor is used during this process to monitor whether the gripping unit has actually picked up a drill pipe and whether it is present during the entire supply process. A highly resistant sensor from the Varikont series—in a rugged housing with an extended temperature range of $-40\text{ }^{\circ}\text{C}$ to $100\text{ }^{\circ}\text{C}$ —is used to provide the perfect match even for extreme offshore conditions.

Ruggedness Meets Innovation

Pepperl+Fuchs offers a portfolio that is perfectly tailored to valve position detection systems in the process industry. Regardless of the operating location or drive, the range covers sensors for indoor and outdoor applications, and extreme ambient conditions. Extensive engineering know-how and years of experience in explosion protection ensure reliable solutions for these unique application requirements.





Innovative Solutions for Valve Position Detection

Pepperl+Fuchs developed the unique concept of the dual sensor for position detection on valves. It combines two adjacent or overlapping inductive sensor elements that detect the position of an actuator to determine the position of the valve (open/closed). The innovative concept reduces installation costs, and the wear-free noncontact sensing technology ensures that the devices are extremely durable and low-maintenance. Suitable actuators are available for the entire range of modern drives. This includes rugged models with highly visible valve position indicators that consist of an actuator and two-color visual on/off display.

Highlights

- Easy to mount on standard valve actuators without the need for additional mounting aids
- Open solution with integrated high-visibility valve position indicator
- Flexible, modular housing design
- Tightly sealed thanks to inductive, noncontact detection of the valve position

Selected technical data	F25 series		F31 series		F31K2 series
					
Search term	N*-F25*	N*-F25K*	N*-F31*	N*-F31K*	N*-F31K2*
Output type	3-wire DC, 2-wire DC (small residual current), NAMUR		3-wire DC, 2-wire DC, NAMUR, AS-Interface		3-wire DC, 2-wire DC (small residual current), NAMUR
Housing material	Glass fiber reinforced plastic				Glass fiber reinforced plastic or translucent plastic, aluminum
Temperature range	-25 ... 70 °C				-40 ... 70 °C
Degree of protection	IP67				IP66, 67, 69K
Certification	NAMUR (Ex i)		NAMUR (Ex i), SIL 2		NAMUR (EX i), SIL 2, 2-wire, DC (Ex nA, Ex tc), small residual current, 3-wire, DC (Ex nA, Ex tc)

Functional Safety in Extreme Conditions

Pepperl+Fuchs offers a range of sensors that were developed specifically for the requirements of modern process plants. Open solutions for valve position detection are a highlight: From standard to extreme applications, the portfolio offers simple operation and maximum reliability.





Solutions for Valves of All Types and Sizes

The valve position detection portfolio consists of three sensor series. Depending on the drive size, these can be combined with one of two actuators to ensure the optimal solution for any application requirement. The F25/F25K series is used for small basic applications, such as manual valves in indoor areas. It is available as a cable, plug, or terminal compartment version and combines the two sensor elements in the smallest possible space.

The F31/F31K series is used in applications on standard valve actuators in indoor and outdoor areas. It is easy to install and is also available for hazardous areas. The F31K2 series is designed for outdoor use. It combines high flexibility, ruggedness, and excellent performance—even under extreme conditions.

Specialists for Mobile Equipment



Reliability under the Toughest Conditions

Applications in the mobile equipment sector place highly specific demands on sensor technology. In addition to approval for road traffic (E1 type approval), these proximity sensors must also have EMC immunity. Other typical requirements include high impermeability, resistance to shock, vibration, and chemicals, and an extended temperature range of $-40\text{ }^{\circ}\text{C}$ to $+85\text{ }^{\circ}\text{C}$. With this in mind, Pepperl+Fuchs offers an extremely broad portfolio that guarantees maximum flexibility. The selection includes exceptionally rugged devices which, thanks to a special internal test procedure, ensure a level of impermeability beyond the IP68 standard—a new benchmark in quality.

Highlights

- Maximum mechanical and electrical properties for reliable operation in the harshest outdoor conditions
- Optimized for mobile equipment (E1 type approval for use on public roads)
- Comprehensive portfolio and application-specific adaptations for maximum flexibility in sensor selection
- The highest quality standards (internal testing according to criteria far beyond the normative requirements)

Selected technical data	12GM series	18GM series	30GM series	F148 series
				
Search term	N*-12G*-M1	N*-18G*-M1	N*-30G*-M1	N*-F148-*-M
Max. sensing range				
Flush	4 mm	8 mm	15 mm	15 mm
Non-flush	8 mm	12 mm	25 mm	25 mm
Temperature range	$-40 \dots 85\text{ }^{\circ}\text{C}$			
Output type	PNP, NPN, DC 3-wire			
Housing material	Brass nickel-plated			Anodized aluminum
Dimensions	Ø M12	Ø M18	Ø M30	50 × 35 × 20 mm

Mobile Machinery: Position Monitoring for Safe Workflows

To prevent tipping as mobile cranes lift and move loads of several tons, the vehicles must be secured. To this end, the cranes have support legs that are extended according to the terrain and the load. Inductive sensors are used to monitor the position of the extended/retracted support legs.

For such applications, Pepperl+Fuchs offers a flat proximity sensor that is ideal for installation in the limited space between the vehicle trim and the support leg. With a heavy-duty design and approval for road traffic, the sensor also ensures reliability and safety in mobile agriculture, forestry, construction, and mining machines.

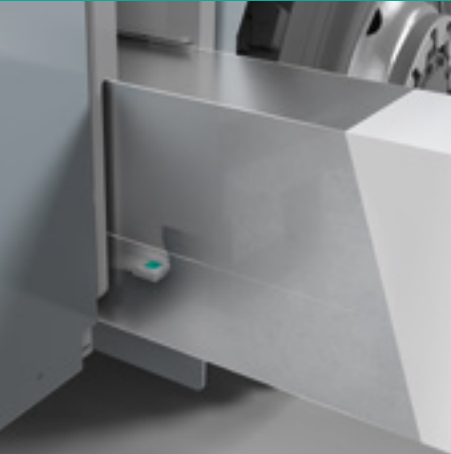

Reliable Detection of Nonmetallic Objects









Durable and Rugged

Capacitive proximity sensors are the perfect solution for detecting nonmetallic objects and substances. Whether for liquids, granules, paper, or wood, they reliably monitor the fill level in production processes. A wide variety of designs and sensing ranges ensures flexible use in virtually every kind of application. In the agricultural industry or wood processing industry, they are used to monitor the fill level of liquids and solids. In process engineering in the chemical and pharmaceutical industries, they enable reliable detection of materials in plastic containers. Particularly rugged, durable versions made of stainless steel or chemically resistant housing material are available for use in harsh industrial environments.

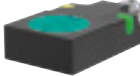
Highlights

- Highest quality standards in sensor production ensure application reliability
- Perfect solution for detecting nonmetallic objects
- Extreme ruggedness and durability, perfect for use in harsh industrial environments
- Application-related advice at the highest technical level

Selected technical data	12GH70 series	30GS/30GK series	F46 series	F104M series	F64 series	VariKont series	FP series
							
Search term	C*-12G*	C*-30G*	CB*-F46*	CBN5-F104M*	CBN15-F64*	CJ15+U1+A2	FPCJ40-FP*
Max. sensing range							
Flush	4 mm	10 mm	10 mm	5 mm	15 mm	15 mm	40 mm
Non-flush		15 mm					
Output type	DC 3-wire PNP/NPN, NAMUR	DC 3-/4-wire PNP/NPN	DC 3-wire PNP/NPN	DC 3-wire PNP	DC 3-/4-wire PNP/NPN	DC 4-wire PNP	DC 4-wire PNP/NPN
Housing material	PBT plastic/ stainless steel 1.4404/AISI	PBT plastic/ stainless steel 1.4305/ AISI	PBT plastic	Metal/PA	PBT plastic	PBT plastic/metal	PBT plastic/metal
Dimensions	Ø M12	Ø M30	50 × 20 × 5 mm	32 × 20 × 8 mm	40 × 25 × 12 mm	40 × 40 × 118 mm	80 × 80 × 40 mm

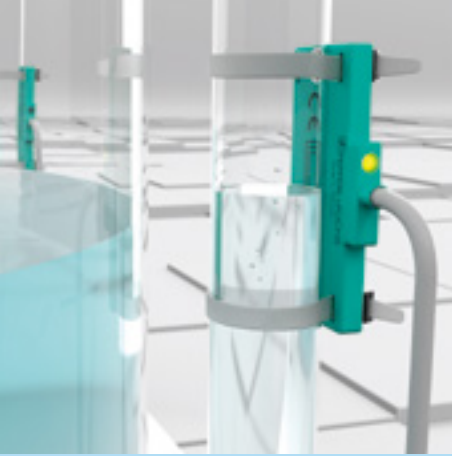

Precise Fill Level Monitoring

To prevent plant shutdowns in liquid and powder mixing plants, it is necessary to continuously check whether there is sufficient media in containers. F46 series sensors are used: as soon as a defined fill level is reached, the capacitive proximity sensors send a message to the control system to initiate refilling. In tanks made of nonconductive material, the capacitive sensors can also determine the fill level from the outside. Extremely slim housing designs and the versatile mounting holes make the sensors easy to mount. Highly visible LEDs indicate whether a substance is detected or not.

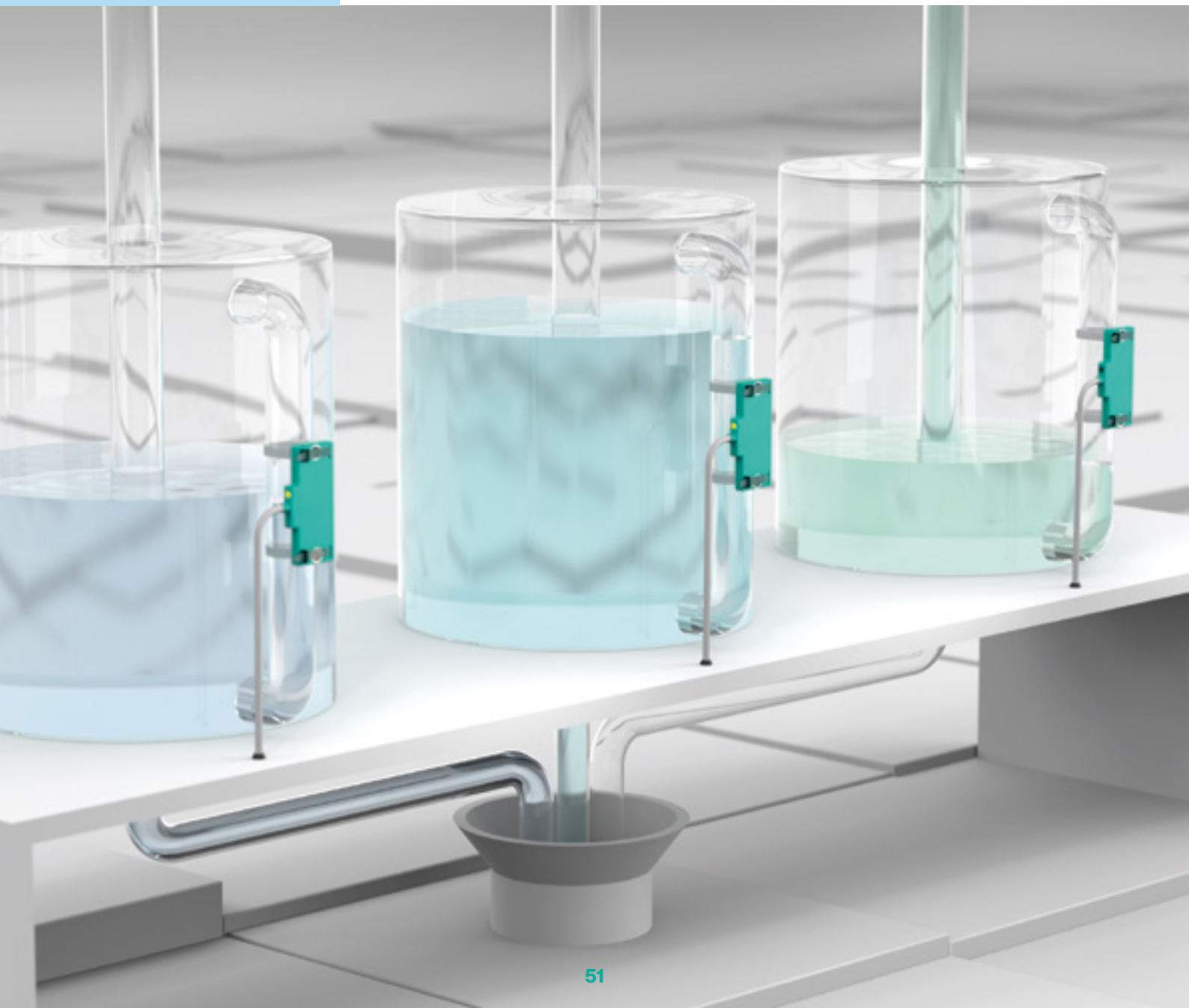

Multipurpose Sensors for Demanding Tasks

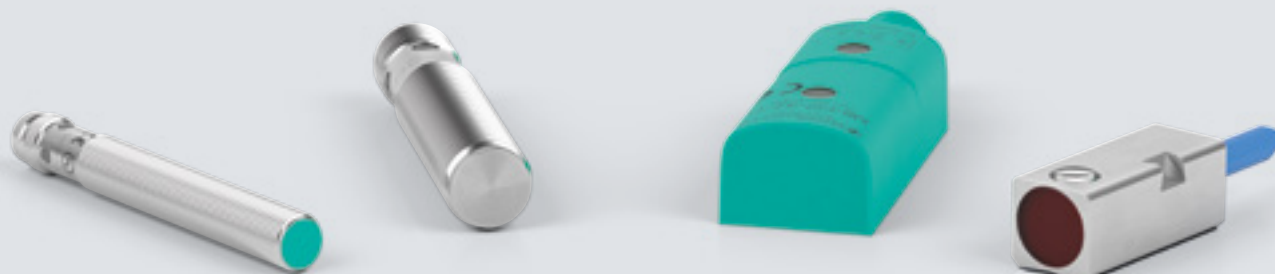

Fast Processes, High Sensing Ranges

Where the technology of inductive sensors reaches its limits, magnetic field sensors are a highly versatile alternative. They can reliably detect magnetic fields through non-magnetizable materials. Pepperl+Fuchs offers an optimized portfolio of cylindrical and cube-style housings in different designs and sizes. Versions with sensing ranges of up to 70 mm, high switching frequencies of up to 5,000 kHz, and a wide range of output and connection options ensure the optimal solution for any application requirement.

Sensors are available in plastic and stainless steel, and special NAMUR versions enable use in hazardous areas. Sensor versions made of stainless steel with an IP protection class up to IP69 are also available for particularly demanding conditions. Rugged designs and noncontact detection make these sensors durable and maintenance-free.

Selected technical data	8GM series	12GM/12GS series 18GH series	F32 series	F12 series
				
Search term	MB*-8GM*	M*-12G*, M*-18G*	MB-F32*	MJ35-F12*
Max. sensing range	60 mm	60/70 mm	– (switch width 50 mm)	35 mm
Switching frequency	5,000 Hz	5,000 Hz	–	5,000 Hz
Output type	DC, PNP	DC, PNP, NAMUR	DC, PNP	DC, NAMUR
Approvals	CE, UL	CE, UL, ATEX	CE	CE, ATEX, FM
Dimensions	Ø M8	Ø M12/M18	21 × 18 × 75 mm	12 × 12 × 30 mm

Highlights

- Detection of magnetic fields through non-magnetizable materials
- Extremely rugged design
- Long service life due to noncontact detection
- High switching frequencies (up to 5,000 kHz) ensure quick and reliable process flows
- Special models with approvals for hazardous areas

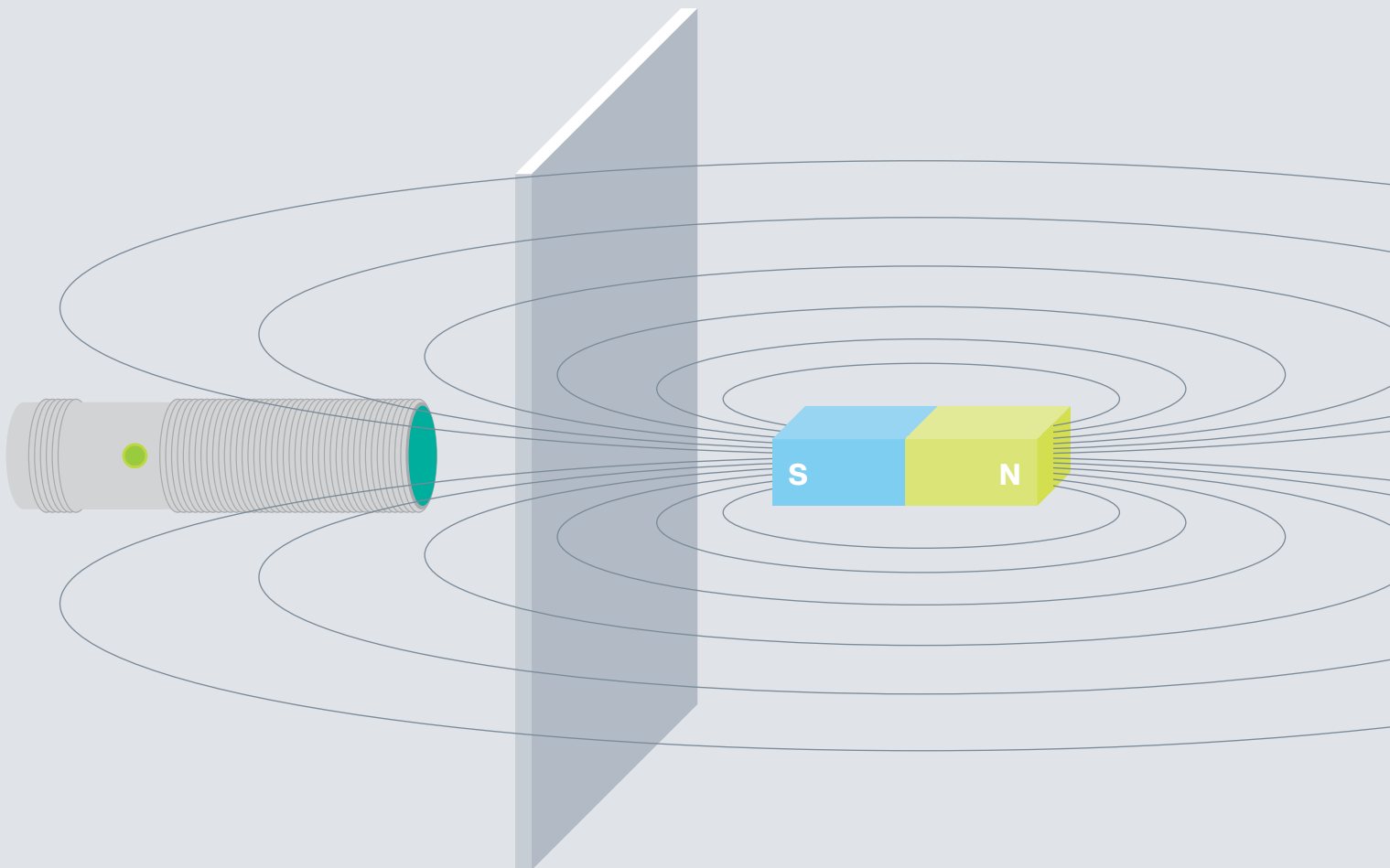

Detection of Magnetic Fields

The sensors are able to detect a magnetic field through non-magnetizable materials. This is particularly advantageous if the object to be detected or the sensor itself does not have direct visual contact with the object.

The Perfect Addition: Accessories and Other Components

Perfectly coordinated connectivity and mounting accessories make optimal sensor integration possible. The comprehensive range of accessories from Pepperl+Fuchs offers the components necessary for ready-to-install solutions.



Pepperl+Fuchs Connectivity

- **Sensor-actuator cables**—numerous connection and cable types that can be used worldwide for a tailor-made solution
- **Field-attachable connectors**—a wide range of connectors suitable for a diverse range of applications
- **Junction blocks**—M8 and M12 distributors with a molded master cable for reduced installation costs
- **Sensor-actuator splitters**—for easy merging of two signals at a single slot
- **Receptacles**—signal routing from the switch cabinet directly into the field
- **Data connectors**—for reliable networking between the components of an automation system

Large Selection of Cable Types

Each operating environment has its own requirements. The mechanical and chemical properties of the connection technology used are a crucial aspect in determining the solution. Pepperl+Fuchs offers the exact cable types that you need.

- PVC—solid and economical
- PUR—durable and highly flexible
- PUR U—highly flexible with UL approval
- PUR A—resistant to welding sparks for the automotive industry
- PUR O—rugged for demanding outdoor applications
- PUR-R—highly flexible for demanding robotic applications
- STOOW—designed specifically for the American market
- POC—specifically for the welding industry

Rugged Connectivity for Mobile Applications

The Mobile Equipment Connectivity (MEC) series from Pepperl+Fuchs is designed for use in the harshest ambient conditions and offers maximum reliability in mobile applications.

- Fully molded, encapsulated DT connectors
- IP68 protection, UV and oil resistance, and a large temperature range of $-50\text{ }^{\circ}\text{C}$... $105\text{ }^{\circ}\text{C}$ for extreme outdoor applications
- Corrugated tube latching mechanism provides additional protection for demanding applications
- Individual cable configuration for solving a wide variety of applications



Cable Protection System for Cylindrical Sensors

Various requirements in the installation environment require cylindrical sensors and their cables to be protected. With the wide range of sensor adapters, flexible conduits, and cable glands in industry-standard sizes, the first choice of sensor can be used in spite of adverse conditions.

The concept guarantees the optimal protection of the cable against mechanical and chemical influences. Thanks to the integrated seal of the gland, the electronics in the terminal box are protected against penetrating liquids and process flows.

Additional Components for Optimal Integration

Mounting adapters, gland adapters, and mounting fixtures are available for all sensors in the Pepperl+Fuchs portfolio to ensure optimal integration into your machine or plant.



For more information, visit
pepperl-fuchs.com/pf-accessories



Our Solutions, As Individual As You.

Automating processes often requires custom sensing solutions to ensure seamless integration. And when designing these solutions, the requirements of our customers are just as diverse as the customers themselves. Based on decades of experience and sound technical know-how, we collaborate with you to develop the perfect sensing solution.

Customized Sensors and Systems

Completely Customized, Seamlessly Integrable

Handing your sensing needs over to the specialists offers clear advantages: you always get a technically superior solution—quickly and with no compromises. In addition, seamless integration into existing systems and the right support are always guaranteed.

This is why Pepperl+Fuchs offers custom sensors and systems in addition to a huge standard portfolio. This ranges from the modification of existing products, such as customizing housing designs, to the collaborative development of new sensors, to the development and integration of entire sensor systems.

You get exactly what you need—technically perfect solutions for a clear competitive advantage.

Highlights

- Best possible advice and identification of the right sensing solution
- Customer-specific solutions, from customized cable lengths to newly developed products
- Seamless system integration for perfect processes
- The right solution, no compromises

Consulting

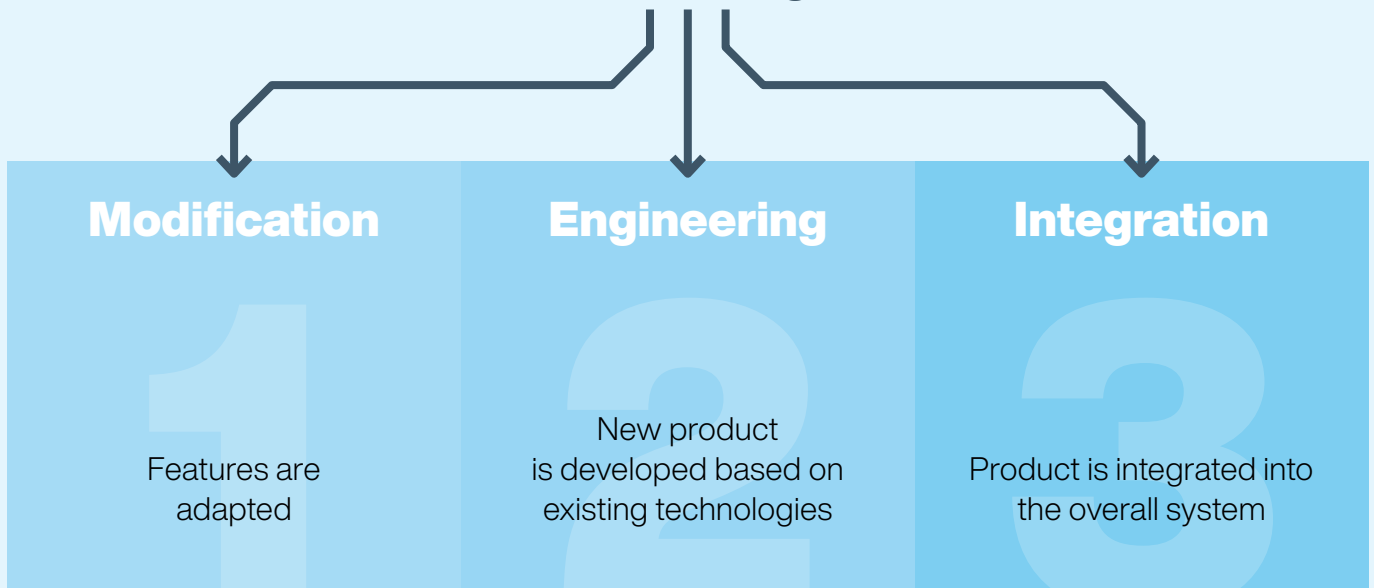

For more information, visit
pepperl-fuchs.com/if-solutions

Unique Solutions from the Inventor of the Proximity Sensor

Application-specific housing designs, different operating principles, special materials, adapted evaluation electronics, optimized connection technology—all these are characteristics of an individual sensor solution. Pepperl+Fuchs also offers countless sensor customization possibilities for an individual and technically perfect solution in the field of proximity sensors.

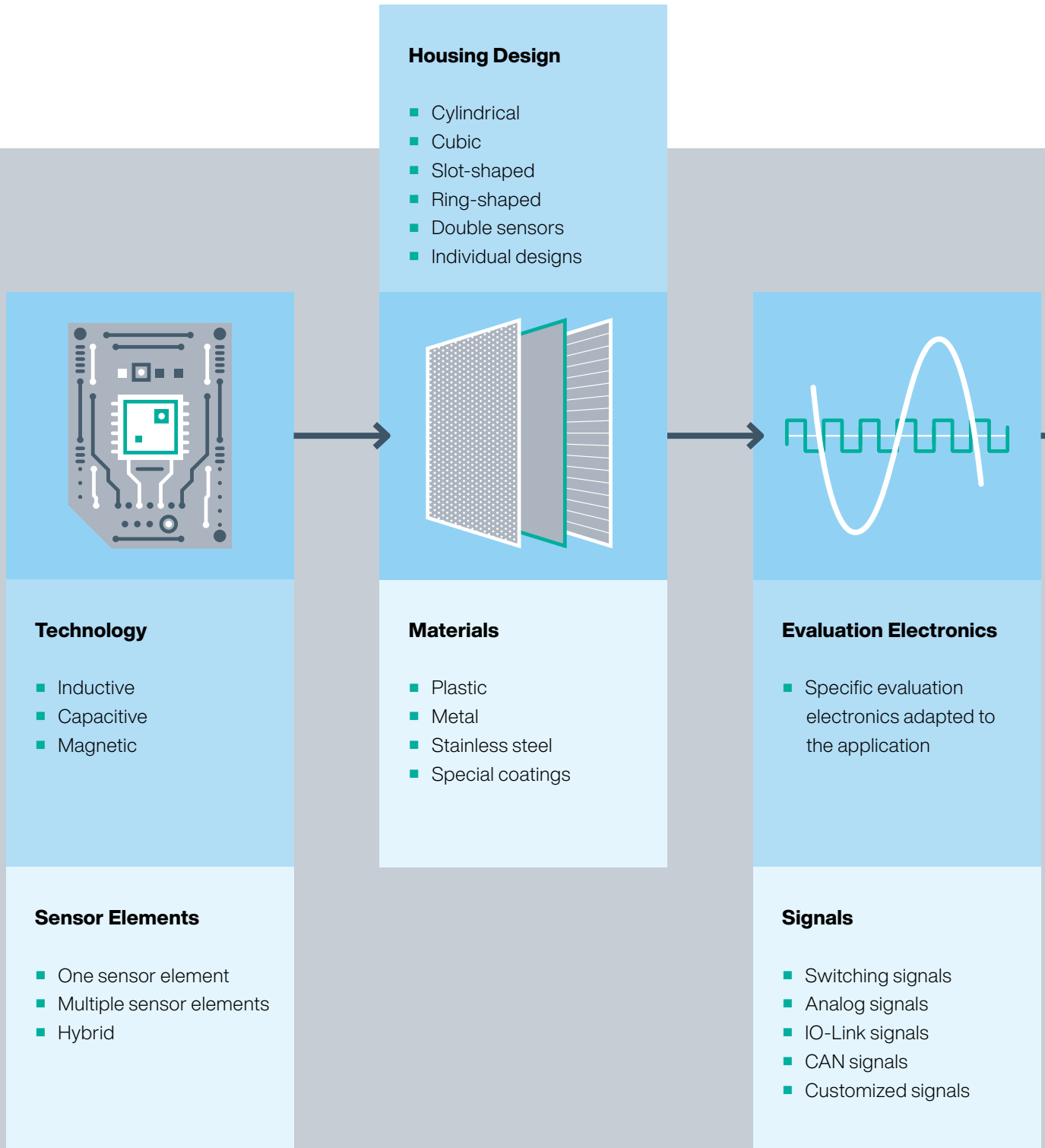

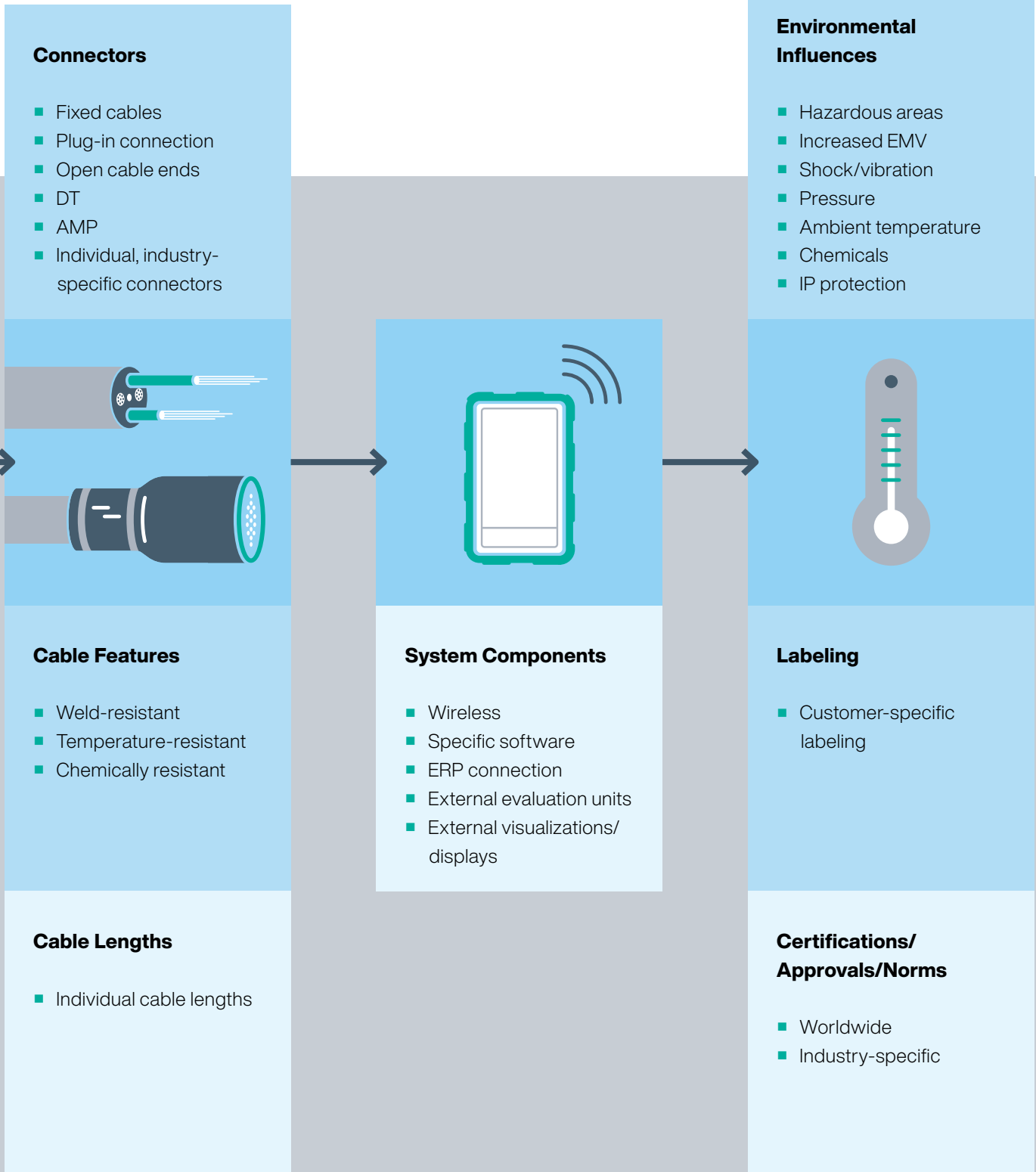

Your automation, our passion.

Explosion Protection

- Intrinsic Safety Barriers
- Signal Conditioners
- FieldConnex® Fieldbus Infrastructure
- Remote I/O Systems
- Electrical Explosion Protection Equipment
- Purge and Pressurization Systems
- HMI Systems
- Mobile Computing and Communications
- HART Interface Solutions
- Surge Protection
- Wireless Solutions
- Level Measurement

Industrial Sensors

- Proximity Sensors
- Photoelectric Sensors
- Industrial Vision
- Ultrasonic Sensors
- Rotary Encoders
- Positioning Systems
- Inclination and Acceleration Sensors
- Vibration Sensors
- Industrial Ethernet
- AS-Interface
- IO-Link
- Identification Systems
- Displays and Signal Processing
- Connectivity

www.pepperl-fuchs.com

Subject to modifications • © Pepperl+Fuchs
Printed in Germany • Part. No. 049506 04/23 16 • public



Pepperl+Fuchs Quality

Download our latest policy here:

www.pepperl-fuchs.com/quality