

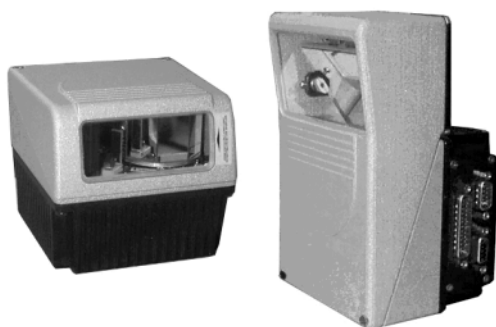

INSTRUCTION MANUAL

BARCODE READER VB34



CE

With regard to the supply of products, the current issue of the following document is applicable: The General Terms of Delivery for Products and Services of the Electrical Industry, published by the Central Association of the Electrical Industry (Zentralverband Elektrotechnik und Elektroindustrie (ZVEI) e.V.) in its most recent version as well as the supplementary clause: "Expanded reservation of proprietorship"

We at Pepperl+Fuchs/VISOLUX recognize a duty to make a contribution to the future.
For this reason, this printed matter is produced on paper bleached without the use of chlorine.

1	REFERENCE INFORMATION	4
1.1	ADDITIONAL DOCUMENTATION	4
1.2	Maintenance, support and warranty	4
1.2.1	Maintenance and support	4
2	Safety regulations	4
2.1	Electrical safety	4
2.2	Laser safety	4
2.2.1	Standard regulations.....	4
2.3	Voltage supply	6
3	Device views	6
4	Installation overview	9
4.1	Point-to-point installation	9
4.2	Lonworks master/slave installation	9
5	Introduction	11
5.1	Product description	11
5.2	Available models	13
5.3	Displays	13
5.4	Oscillating mirror models	13
5.5	Accessories	16
6	Installation	16
6.1	Contents of the package	16
6.2	Mechanical installation	17
6.2.1	Installation of the reader	17
6.2.2	Installation of the reader with accessories	20
6.3	Electrical connections	21
6.3.1	Primary/secondary interface and I/O connections	23
6.3.2	Lonworks connector	32
6.3.3	Ethernet connector	35
6.3.4	DeviceNet connector	37
6.3.5	Profibus connector	37
6.3.6	Voltage supply	38
6.4	Operator interface	39
6.5	Adjusting the reader	39
6.6	Typical installations	41
6.6.1	Standard installation	41
6.6.2	Installation with an angle of rotation of 45°.....	41
6.7	Typical hardware configurations	42
6.7.1	Point-to-point	42
6.7.2	Loops	43
6.7.3	RS232 master/slave	45
6.7.4	Multiplexer	46
6.7.5	Local Lonworks network.....	47
6.7.6	Fieldbus network.....	50
6.8	FLASH™ dynamic focusing	51
6.8.1	Fixed adjustment	52

Barcode reader VB34

Table of contents and general information

6.8.2	Continuous adjustment	52
6.8.3	Trigger operating mode	52
6.8.4	D-Flash™ operating mode.	53
6.9	Key field and display	53
6.9.1	Internal Net	53
6.9.2	Test mode	54
7	Software configuration	54
7.1	Software installation	54
7.2	Hints on quick configuration	55
7.2.1	Assistant for quickly setting up the reader	55
7.2.2	Network Assistant	58
7.3	Enhanced configuration	59
7.4	Basic settings for parameters	60
8	Optical properties	63
8.1	ACR technology (ACR™ 3 reconstruction)	63
8.1.1	Tilt angle for the ACR reconstruction.	64
8.2	PackTrack™	65
8.2.1	PackTrack™ calibration	66
8.3	Read diagrams	68
8.3.1	VB34 standard model	69
8.3.2	VB34 model with reflex mirror	79
9	Maintenance	89
9.1	Cleaning	89
10	Troubleshooting	89
11	Technical data	93
12	Glossary	95
13	Notes	99

General information



Warning

This symbol warns the user of possible danger. Failure to heed this warning can lead to personal injury or death and/or damage to equipment.



Attention

This symbol warns the user of the possibility of device failure. Failure to observe this warning can lead to the complete failure of the device or any device connected to it.



Note

This symbol advises the user of important tips.

Declaration of conformity

We, Pepperl+Fuchs GmbH, declare herewith at our sole responsibility that the

Barcode Scanner VB34

and all models of this product to which this declaration pertains, are compliant with the following standards and other regulating documents

EN 55022, August 1994: RADIO INTERFERENCE OF INFORMATION TECHNOLOGY EQUIPMENT (ITE), MEASURING METHODS AND LIMITS

EN 50082-2, March 1995: ELECTROMAGNETIC COMPATIBILITY, GENERIC IMMUNITY STANDARD PART 2: INDUSTRIAL AREA

and the guidelines of the following directive(s):

89/336 CEE AND SUBSEQUENT CHANGES MADE,
92/31 CEE; 93/68 CEE



Note

A corresponding declaration of conformity may be requested from the manufacturer.

Pepperl+Fuchs GmbH, in D-68301 Mannheim, has a certified quality assurance program in accordance with ISO 9001.



1 REFERENCE INFORMATION

1.1 ADDITIONAL DOCUMENTATION

The following additional documentation on the VB34 system is available:

- C-BOX100 manual
- GFC-60 90° deflecting mirror
- GFC-600 90° near range deflecting mirror
- Documentation on Profibus communication

1.2 Maintenance, support and warranty

1.2.1 Maintenance and support

Pepperl+Fuchs offers a range of services as well as technical support via its website. For further information, visit our website at www.pepperl-fuchs.com.

2 Safety regulations

2.1 Electrical safety

This product meets the applicable requirements stipulated by the European standard EN 60950 on electrical safety in the version valid at the time of production.

2.2 Laser safety

The following information is listed for compliance with the rules defined by the international authorities and refers to the proper use of the VB34 reader.

2.2.1 Standard regulations

This reader is provided with a low-energy laser diode. Even though, according to the current state of knowledge, directly looking into the laser beam does not cause any biological damage, you should avoid doing this as for all strong light sources such as the sun.

Do not direct the laser beam, neither directly nor indirectly, e.g. via mirrors, into the eyes of other people.

This product meets the applicable requirements of the European standard EN 60825-1 and the standard CDRH 21 CFR1040 in the version valid at the time of production. The reader is classified as a class 2 laser product according to EN 60825-1 and as a class II laser product according to the CDRH regulations.

Before opening the device for maintenance or installation purposes, switch off the voltage supply in order to avoid exposure to dangerous laser radiation.

The device is equipped with a safety device, which only switches on the laser if the motor has reached the minimum rotational speed for read mode.



Warning

The use of different controls or settings as well as carrying out operations other than those described here may cause exposure to dangerous, visible laser radiation.

Laser radiation is visible to the human eye and is emitted through the window in the head of the reader (Figure 3.1 and Figure 3.2).

Warning labels that draw attention to the dangers of laser radiation and to the device classification are located on the head of the reader (Figure 3.1 and Figure 3.2):



Figure 2.1 Laser safety labels for oscillating mirror and standard models

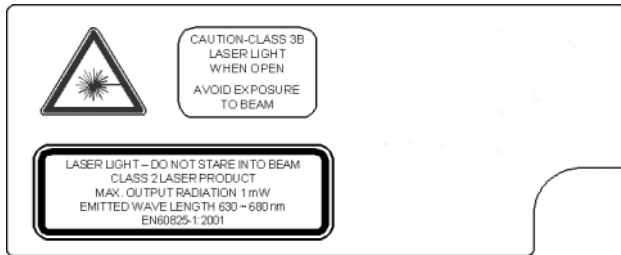

Figure 2.2 Warning and device classification labels

The name plate is located on the lower part of the reader (Figure 3.1):

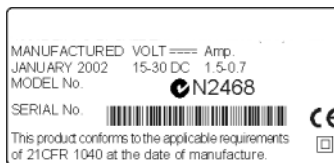

Figure 2.3 Name plate

The laser diode used by this device is classified as a class 3B laser product according to EN 60825-1 and as a class IIIb laser product according to the CDRH regulations. As it is not possible to attach a label to the laser diode used by this device, the following label is alternatively shown here:

Barcode reader VB34

Device views

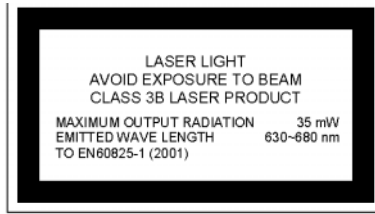

Figure 2.4 Classification label of the laser diode

Opening the optical components may cause radiation to be emitted with the maximum power of the laser diode (35 mW at 630–680 nm).

2.3 Voltage supply

This product may be installed by qualified personnel only.

All VB34 models:

This device is designed for supply by a UL-listed power pack with the classification “Class 2” or by a low-voltage power pack, which connects the supply voltage directly via the 25/26-pin connector to the reader.

3 Device views

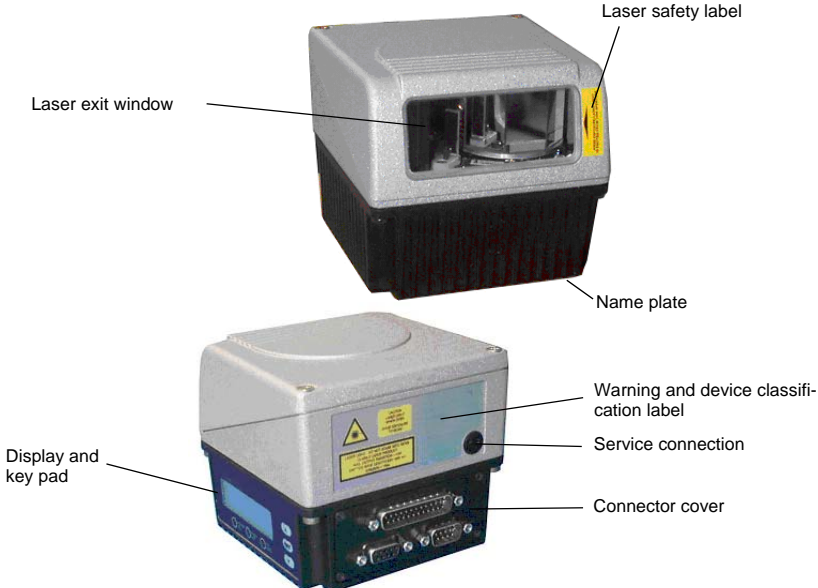

Figure 3.1 Device view VB34

Date of issue 06/13/2005

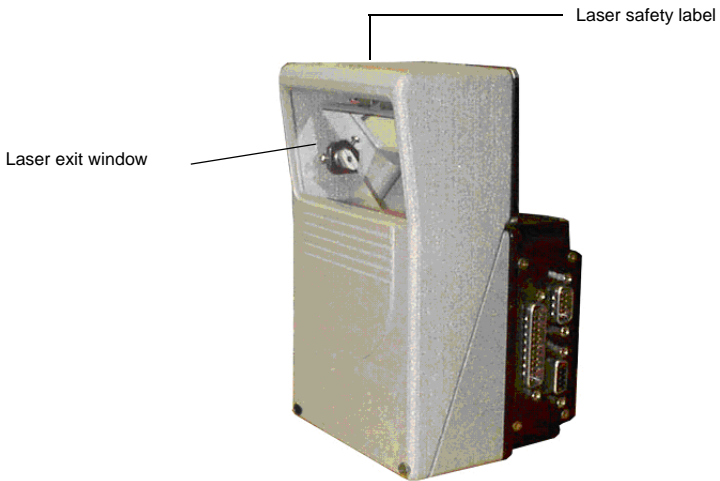

Figure 3.2 Device view VB34 reflex mirror version

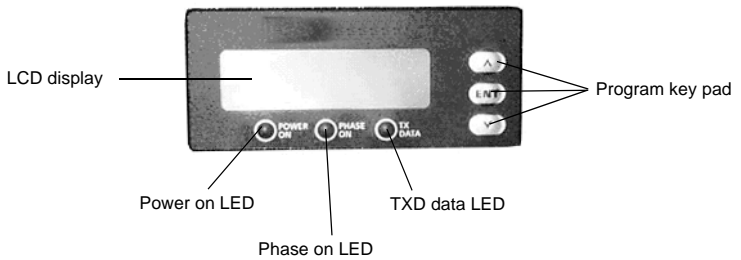

Figure 3.3 Partial view of display and key pad

Barcode reader VB34

Device views

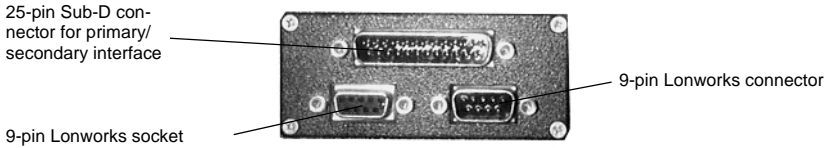

Figure 3.4 View of connector cover for master/slave models

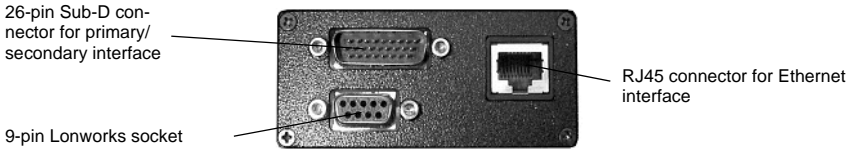

Figure 3.5 View of connector cover for Ethernet models

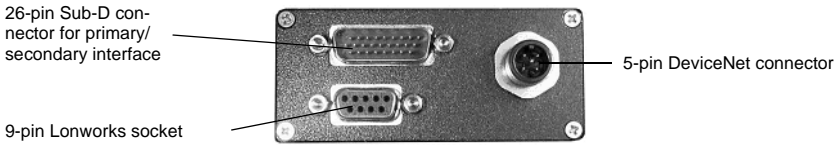

Figure 3.6 View of connector cover for DeviceNet models

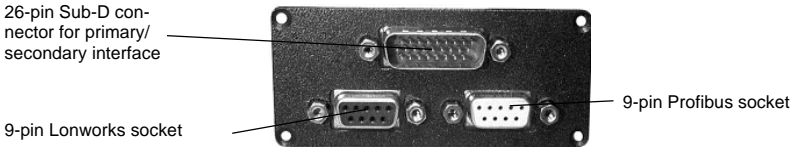

Figure 3.7 View of connector cover for Profibus models

4 Installation overview

4.1 Point-to-point installation

The following overview can also be used as a check list. It lists all the steps that are required for a complete installation of the VB34 reader.

1. Read all the information in section "Safety instructions" at the beginning of this manual.
2. Install the reader using the supplied mounting material (Chapter 6.2.2).
3. Adjust the reader to the correct reading distance for your model (Chapter 6.5).
4. Wire the VB34 reader according to the following steps:
 - a) Connect the VB34 reader to a C-BOX 100 (Chapter 5.5) using one of the accessory cables.
 - b) Wire the C-BOX 100 with all system signals and voltages required by your application (trigger, inputs, outputs).
 - Layout: Point-to-point, RS232 master/slave, Lonworks or fieldbus. For further information, please refer to the sections in Chapter 6.7.
 - Cabling: supply, primary serial interface – RS232, RS485 half duplex, RS485 full duplex, 20 mA current loop, secondary interface, inputs, outputs etc. For further information, please refer to the sections in Chapter 6.3.
5. Configure the VB34 reader by installing and executing the configuration software from the enclosed CD-ROM. The most important steps are:
 - Select the codes to be read
 - Configure the communication parameters
 - Define the data format parameters
 - In the test mode, adjust your VB34 reader to the application as described in the configuration software.
6. Complete the configuration program and start your application.

The installation is now complete.

4.2 Lonworks master/slave installation

The following overview can also be used as a check list. It lists all the steps that are required for a complete installation of the VB34 reader.

1. Perform steps 1 to 3 of the point-to-point installation.
2. Wire the VB34 reader according to the following steps:
 - a) Connect the VB34 master reader to a C-BOX 100 (Chapter 5.5) using one of the accessory cables.
 - b) Connect the BTK-6000 termination network to the VB34 master reader as described under "Local Lonworks network" (Chapter 6.3.2).
 - c) Install and wire all slave readers required for your system configuration (Chapter 6.7).
 - d) Connect the BTK-6000 termination network to the last VB34 slave reader as described under "Local Lonworks network" (Chapter 6.3.2).

Barcode reader VB34

Installation overview

Configure the VB34 slave readers using one of the following methods:

- a) Define the addresses of all VB34 slave readers via the key pad on the reader (Chapter 6.9).
- b) Configure all VB34 slave readers by installing and executing the configuration software from the enclosed CD-ROM (Chapter 7.2.2).

Configure the VB34 master readers using one of the following methods:

- c) Configure the VB34 reader as the master using the key pad of the reader (Chapter 6.9).
 - d) Configure the VB34 reader as the master using configuration software (Chapter 7.2.2).
3. Establish a connection to the VB34 master reader in order to configure the network layout using the configuration software.
 4. Configure all VB34 slave readers using the configuration software. The most important steps are:
 - Select the codes to be read
 - Configure the communication parameters
 - Define the data format parameters



All slave readers can also be configured externally using the configuration software and the master reader.

Note

5. In the test mode, adjust your VB34 reader to the application as described in the configuration software™.

The installation is now complete.

5 Introduction

5.1 Product description

The VB34 is the high-performance laser scanner in the VISOLUX family of barcode readers for industrial applications. With its completely new hardware and software platform, it offers innovative and modular solutions regarding performance, communication and maintenance.

Easy installation and operation as well as high flexibility were the most important features during the development of the VB34. Together with the Step-a-Head™ technology, for which a patent has been applied, the innovative mechanics makes it possible to turn the read head and the decoder base assembly independently of each other. Step-a-Head™ makes it possible to always install the VB34 in the ideal position by changing the position of the base assembly while the read head with the laser maintains its optimum position. This minimises the space requirements and simplifies the installation.

Another innovation of the VB34 is the linear motor, which can be used to control the reading position of the scanner via software. This dynamic system with the name Flash™ is able to assume any reading position from the minimum position to the maximum position in less than 10 ms. In typical applications with a reading distance of less than 1 m, the reading position is reached in 4 ms.

Thanks to a new generation of decoders with StrongARM CPU and ACR technology (ACR™ 3 reconstruction), the VB34 reads all current barcodes, even under demanding ambient conditions.

The reader is also available in a version with an integrated, software-programmable oscillating mirror.

Another focus in the system design was the communication capacity of the readers. As interfaces, Lonworks, Profibus, DeviceNet and Ethernet were each integrated into a separate version of the decoder base assembly.

Some of the significant features of the VB34 are:

- Read rate of up to 1200 read processes/second
- 2 serial interfaces
- Reading all current codes
- Operating voltage of 15 to 30 V DC
- All electrical connections pluggable
- Fast Lonworks interface for master/slave configurations
- Supports Profibus, DeviceNet and Ethernet
- 5 operating modes for an optimum adjustment to different application requirements
- Light source: laser diode with a wave length of 630 to 680 nm
- IP64-protected housing (for Ethernet models not yet available)

Auto-ID applications are traditionally used in the area of production. With increasing marketability, standard solutions and a dynamic competition develop. The VB3x family with the model VB33 also has its roots in production applications. The VB34 opens up new areas of application such as, for example, transport and logistics applications, in which the practical advantages of the new technologies come to the fore.

Barcode reader VB34 Introduction

Feature	Practical use
Modular solution with separate head and base assembly as well as Step-A-Head™ function	<ul style="list-style-type: none"> • Combination of the ideal head and base assemblies for a given application • Scaleable solution • Reduced tool life, as the decoder base remains functional even when the head has been removed. • Simple maintenance: All configuration parameters remain saved in the base assembly. When the read head is replaced, the scanner is configured automatically. • Simple installation with minimum space requirement
Reading pallets or large objects over greater distances and with a large field of view	<ul style="list-style-type: none"> • VB34 with dynamic focussing system Flash™.
Reading objects on conveyor belts	<ul style="list-style-type: none"> • VB34 implements Packtrack™ functionality in order to increase the production of the plant by a higher system throughput.
Master is used as multiplexer in fast Lonworks environments	<ul style="list-style-type: none"> • Economically, a very attractive offer as there are no costs for the external multiplexer. • High data throughput of 1.2 Mbit/s on a sturdy, industry-proof bus.
Configuration software	<ul style="list-style-type: none"> • Short learning time thanks to integrated wizard • Multi-language platform • All configuration parameters are saved in the reader. • Independent of the installed hardware interface

5.2 Available models

The VB34 scanner is available in various versions, which differ in the following features:

- Optical system (head)
- Decoder (base assembly)

The following models are available:

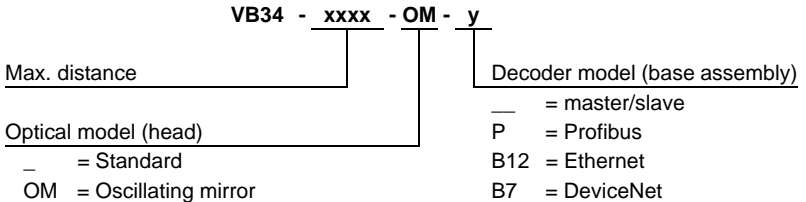

5.3 Displays

The VB34 decoder base assembly has an LCD display for system messages and menus of the configuration software. The three keys on the side of the display are used for navigating in the menus of the configuration software (Figure 3.3).

The three status LEDs have the following functions:

- Power ON (Red) indicates that the reader is switched on (Figure 3.3)
- Phase ON (Yellow) indicates that the presence sensor is activated (Figure 3.3).
- TX Data (Green) indicates that the primary serial interface transmits data without errors (Figure 3.3).

5.4 Oscillating mirror models

Oscillating mirror models are used when large reading areas must be covered, mainly in the case of horizontal barcodes (picket fence barcodes).

The VB34 contains a special optical head with an integrated oscillating mirror, which is driven by a linear motor. Speed, precision, repeatability and reliability of this drive technology guarantee a high performance.

The new oscillating mirror is completely software-controlled and programmable. The configuration™ software makes it possible to adjust the speed of the linear motor (and thus the oscillation frequency) as well as the upper and lower end position for the oscillation process as an angle.

If the oscillating mirror is programmed to read barcodes at a very small angle, position the reader in such a way that the visual angle is at least 10° (Chapter 6.4). This angle mirrors the smallest deflection or the scanning line that is closest to the horizontal. All other scanning lines have a visual angle of more than 10°. This prevents a direct reflection of the laser beam emitted by the reader.

Barcode reader VB34 Introduction

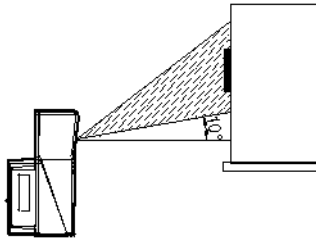

Figure 5.1 Visual angle for oscillating mirror models

Otherwise, the scanner can be installed with a tilt angle of 17.5° in order to achieve a horizontally symmetric deflection range.

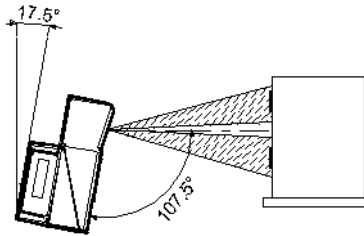

Figure 5.2 Reading position of the oscillating mirror

In the above example, the zone in which the scanning lines meet the reflecting surface vertically corresponds to a neutral area in the middle of the reading field.

The mirror can be deflected by up to 40°. In relation to the central axle of the exit window, the deflection angle is asymmetric.



Figure 5.3 Maximum deflection and asymmetry of the oscillating mirror

By configuring the oscillating mirror speed to 19 Hz, a raster for recording and reading quickly moving objects can be reproduced.

Hz	Max. deflection
0 ... 5	40°
6 ... 10	30°
11 ... 15	20°
16 ... 19	10°



Note

The number of scans on a given reading area can be increased by limiting the raster width to the required minimum.

The oscillating angles are selected in the software. The minimum and maximum values are -2.5° and $+37.5^\circ$ respectively.

The scanner can be tilted so that the software setting of 17.5° lies on the horizontal as a 0° reference.

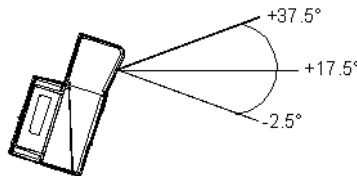

Figure 5.4 End angle position for the oscillating mirror

These models have a higher read rate (1200 read processes/second) than the standard models, which is not influenced by the oscillating mirror.

The following example shows a setting of $+10^\circ$ for the lower line and an angle of $+20^\circ$ for the upper line (see figure below).

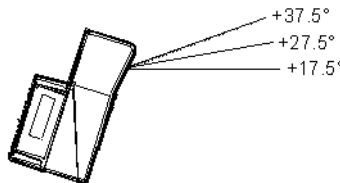

Figure 5.5 Oscillating mirror operation

For details on mounting oscillating mirror model, please refer to Chapter 6.2.1.

Barcode reader VB34 Installation

5.5 Accessories

For the VB34, the following accessories can be ordered:

Accessories	Description
CAB-6002 SH3339	Cable on C-BOX 100, 2 m length
CAB-6005 SH3339	Cable on C-BOX 100, 5 m length
CAB-6012 SH3339	Cable on C-BOX 100, 2 m length (VB34 fieldbus version)
CAB-6015 SH3339	Cable on C-BOX 100, 5 m length (VB34 fieldbus version)
CAB-6102	Master/slave cable, 2 m length
CAB-6105	Master/slave cable, 5 m length
CAB-6112	Master/slave cable, without supply, 2 m
CAB-6115	Master/slave cable, without supply, 5 m
INT-60	20 mA interface card
GFC-600	90° near range deflecting mirror
C-BOX 100	Passive connection box
C-BOX 300	Profibus DP connection box
BTK-6000	Termination networks set (5 units)
FBK-6000	Quick mounting bracket (2 parts)
GFC-60	90° deflecting mirror
US-60	Mounting angle set (5 units) for multiple-side stations

6 Installation

To install the system, proceed as follows

- Select the installation location for the VB34.
- Install the VB34 reader.
- Establish all electrical connections to the system.
- Direct the reader to the barcodes.
- Install the configuration software on the PC.
- Configure the dynamic Flash™ focussing using the configuration software.



Note

If in your system the VB34 reader is connected to a C-BOX100, please refer to the details in section "Additional documentation".

6.1 Contents of the package

When opening the packaging, make sure that the VB34 reader is undamaged and that all parts of the following packing list are contained in the packaging. This packing list contains:

- VB34 reader
- Instruction manual
- CD-ROM with the configuration software
- Mounting angle and screws



Figure 6.1 VB34 - contents of the package

6.2 Mechanical installation

6.2.1 Installation of the reader

Thanks to Step-a-Head™, the VB34 reader can be adjusted and installed in the ideal reading position. By separating the head and the base assembly, you can change the adjustment of the decoder base assembly and thus of the display, key pad and connectors, while the head with the optical reading system maintains its optimum position. The head and the base assembly can be turned independently of each other, thus making a successful installation possible even in critical environments .

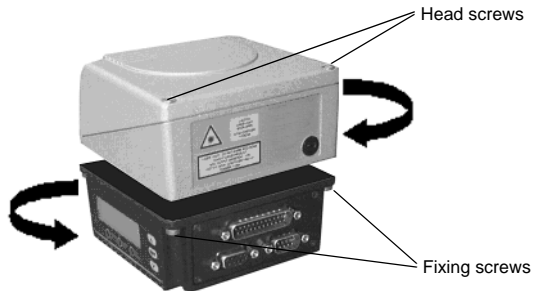

Figure 6.2 Step-a-Head™ function

To turn the head of the reader, perform the following steps:

1. Remove the head from the base by the unscrewing the four fixing screws.
2. Turn the head into the desired position.
3. Unscrew the two screws on the head.
4. Fix the head on the base assembly by tightening the four fixing screws again.
5. Tighten the two screws on the head.

The following figures show the total dimensions of the standard model, the oscillating mirror model and the mounting angles for installation. For a description of the alignment of the reader in relation to the read zone, please refer to Chapter 6.5.

Barcode reader VB34 Installation

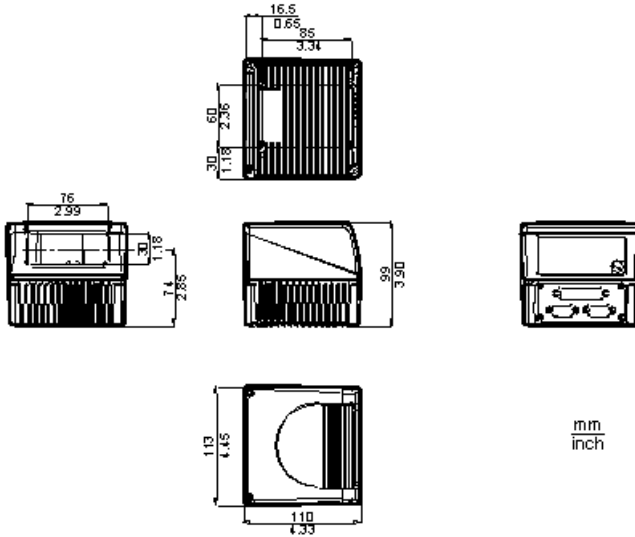

Figure 6.3 Dimensions VB34

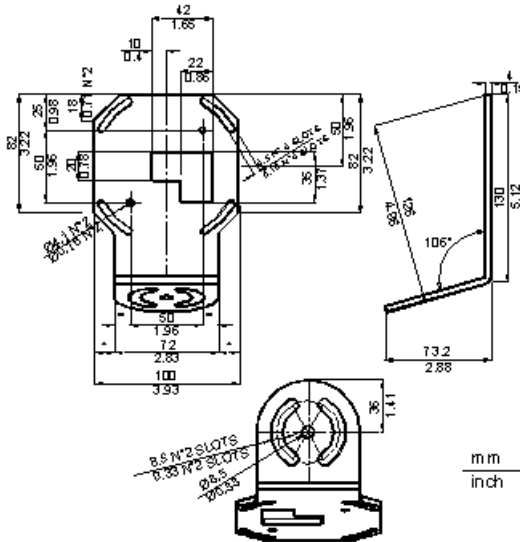

Figure 6.4 Dimensions of mounting angle ST-237

Date of issue 06/13/2005

6.2.2 Installation of the reader with accessories

The following accessories make it possible to install the VB34 reader in the ideal position for network layout:

- ST-237 mounting angle
- ST-210 mounting angle
- FBK-6000 quick mounting bracket

ST-237 is a mounting angle with 105° for mounting the reader as shown in the following figure:

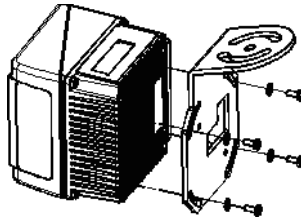

Figure 6.7 Fixing the ST-237 mounting angle

ST-210 is a mounting angle with 90° for mounting the reader as shown in the following figure:

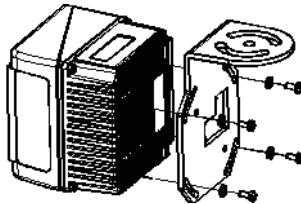

Figure 6.8 Fixing the ST-210 mounting angle

FBK-6000 is a quick mounting bracket set for easily and quickly mounting the reader in ST-210 or ST-237 mounting angles.

First, the FBK-6000 mounting bracket must be fixed to the VB34 reader by means of the screws:

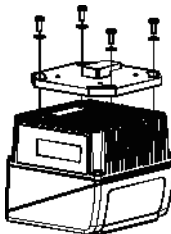

Figure 6.9 Fixing the FBK-6000 mounting bracket to the reader

Afterwards, fix the assembly to the mounting angle by hanging the hook into the recess of the mounting angle. Fix the assembly by means of 2 screws:

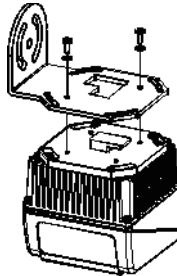

Figure 6.10 Fixing the assembly to the mounting angle

6.3 Electrical connections

The individual reader models have the following connectors:

Reader model	Connector
Master/slave	25-pin connector for interface and input/output connections 9-pin connector, Lonworks 9-pin socket, Lonworks
EtherNet	26-pin connector for interface and input/output connections 9-pin socket, Lonworks RJ45 connector
DeviceNet	26-pin connector for interface and input/output connections 9-pin socket, Lonworks 5-pin connector
Profibus	26-pin connector for interface and input/output connections 9-pin socket, Lonworks 9-pin socket, Profibus

Barcode reader VB34 Installation

The following table shows the assignment of the connectors on the terminal block of the C-BOX 100. Use this connection layout if the VB34 reader is connected to a network via the C-BOX 100:

Connectors on the terminal block of the C-BOX 100				
Power supply				
1, 3, 5	VS			
2, 4, 6	GND			
7, 8	Grounding			
20, 40	Reserved			
Inputs				
27	EXT TRIG A (polarity exchangeable)			
28	EXT TRIG B (polarity exchangeable)			
29	IN 2A (polarity exchangeable)			
30	IN 2B (polarity exchangeable)			
31, 33	IN 3A (polarity exchangeable)			
32, 34	IN 4A (polarity exchangeable)			
36	IN 3B/IN 4B reference earth (polarity exchangeable)			
Outputs				
21	Out 1+			
22	Out 1-			
23	Out 2+			
24	Out 2-			
25	Out 3A (polarity exchangeable)			
26	Out 3B (polarity exchangeable)			
Secondary interface				
35	TX AUX			
37	RX AUX			
38, 39	GND			
Primary interface				
	RS232	RS485 full duplex	RS485 half duplex	20 mA (only INT-60)
11, 15	TX232	TX485+	RTX485+	CLOUT+
12, 16	RTS232	TX485-	RTX485-	CLOUT-
17	RX232	RX485+		CLIN+
18	CTS232	RX485-		CLIN-
10, 14, 19	SGND Signal ground	SGND Signal ground	SGND Signal ground	
9, 13		RS485 Shielding	RS485 Shielding	

Date of issue 06/13/2005

6.3.1 Primary/secondary interface and I/O connections

The VB34 reader has a 25-pin Sub-D connector for connection to computer, voltage supply and input/output signals.

The fieldbus models (Ethernet, DeviceNet and Profibus) of the VB34 are equipped with a 26-pin connector instead of the 25-pin connector.

The connection layout of this connector is shown in the following table:



Figure 6.11 26-pin connector 25-pin connector

VB34 connection layout of the 25/26-pin Sub-D connector		
Pin	Description	Function
1	Shield	The shielding is internally connected with chassis ground via a capacitor.
20	RXAUX	Received data of the RS232 interface (ground-related)
21	TXAUX	Transmitted data of the RS232 interface (ground-related)
8	Out 1+	Plus lead of the digital output 1
22	Out 1-	Minus lead of the digital output 1
11	Out 2+	Plus lead of the digital output 2
12	Out 2-	Minus lead of the digital output 2
16	Out 3A	Digital output 3 - polarity exchangeable
17	Out 3B	Digital output 3 - polarity exchangeable
18	EXT_TRIG A	External trigger (polarity exchangeable)
19	EXT_TRIG B	External trigger (polarity exchangeable)
6	IN 2A	Input signal 2 (polarity exchangeable)
10	IN 2B	Input signal 2 (polarity exchangeable)
14	IN 3A	Input signal 3 (polarity exchangeable)
15	IN 4A	Input signal 4 (polarity exchangeable)
24	IN_REF	Common reference earth for IN3 and IN4 (polarity exchangeable)
9, 13	VS	Supply voltage - plus
23, 25, 26*	GND	Supply voltage - minus (ground)

* Pin 26 is only present on fieldbus models (Ethernet, DeviceNet or Profibus).

Barcode reader VB34 Installation

Connection layout of the connector for the primary interface				
Pin	RS232	RS485 full duplex	RS485 half duplex	20 mA (only INT-60)
2	TX	TX485+	RTX485+	CLOUT+
3	RX	RX485+		CLIN+
4	RTS	TX485-	RTX485-	CLOUT-
5	CTS	RX485-		CLIN-
7	GND_ISO	GND_ISO	GND_ISO	GND**

** For 20 mA current loop, GND lies on the ground potential of the reader voltage supply.

Primary interface

The primary serial interface supports the following interface standards:

- RS232
- RS485 full duplex
- RS485 half duplex
- 20 mA current loop

The 20 mA interface is only available if the INT-60 accessory option is installed. This accessory interface replaces the RS232/RS485 interface.



Note

Interface type and transmission parameters (baud rate, data bits etc.) are configured using the configuration software. For further information, please refer to section "Main Serial Port" in the online help.

For details on the connection and mode of operation of the primary interface, please refer to the following sections.

RS232 interface

In conjunction with a computer, the data of read codes and the configuration of the reader are transmitted via this interface.

Depending on the model, the following pins the 25 or 26-pin connector are used for the RS232 interface:

Pin	Description	Function
2	TX	Send
3	RX	Receive
4	RTS	RTS (request to send)
5	CTS	CTS (clear to send)
7	GND_ISO	Signal ground

The RTS and CTS signals control the data transmission and ensure the synchronisation of the two communication partners.

If the RTS/CTS handshake protocol is active, the VB34 reader sets the RTS output in order to indicate that it wants to transmit a message. The receiver activates the CTS to start the transmission.

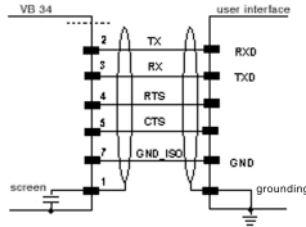

Figure 6.12 Connection layout of the RS232 interface

RS485 interface (full duplex)

The RS485 full-duplex interface is suited for continuous (not running in dialog operation) communication protocols in point-to-point configuration. In this case, greater distances and a higher tolerance towards electrical interfering signals compared with the RS232 interface can be realised.

In full-duplex operation, the RS485 interface uses the following pins of the 25-pin or 26-pin connector:

Pin	Description	Function
2	TX485+	RS485 output (+)
3	RX485+	RS485 input (+)
4	TX485-	RS485 output (-)
5	RX485-	RS485 input (-)
7	GND_ISO	Signal ground

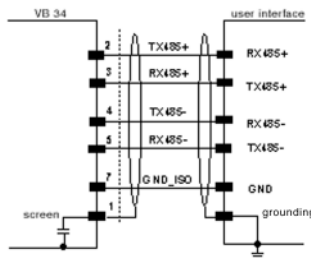

Figure 6.13 Connection layout of the RS485 interface (full duplex)

RS485 interface (half duplex)

The RS485 interface in half-duplex operation is suited for Multidrop connections with a VISOLUX Multiplexer or for master/slave configurations.

In half-duplex operation, the RS485 interface uses the following pins of the 25-pin or 26-pin connector:

Barcode reader VB34 Installation

Pin	Description	Function
2	RTX485+	RS485 input/output (+)
4	RTX485-	RS485 input/output (-)
7	GND_ISO	Signal ground

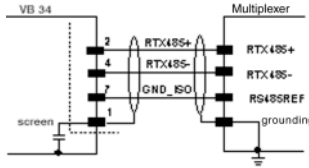

Figure 6.14 Connection layout of the RS485 interface (half duplex)

20 mA current loop (only with INT-60 accessory option)

If the INT-60 accessory card is installed, the VB34 has a 20 mA current loop as the interface. The INT-60 card supports the operation as passive or as active current loop, i.e. as sink or source.

Wiring as source

In the case of an operation as source, the 26-pin connector is wired as follows:

Pin	Description	Function
4	CLOUT-	Current loop output (-)
5	CLIN-	Current loop input (-)
7	GND	Grounding*

** For 20 mA current loop, GND lies on the ground potential of the reader voltage supply.

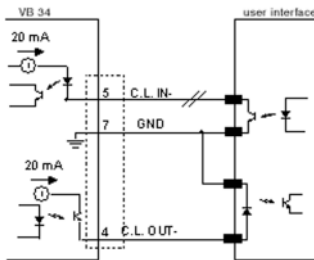

Figure 6.15 20 mA current loop, wiring as source (active)

If the VB34 reader is connected to a C-BOX 100 via a CAB-61X0, the signals are connected to the following terminals of the C-BOX 100:

Pin	Description	Function
12, 16	CLOUT-	Current loop output (-)
5	CLIN-	Current loop input (-)
10, 14, 19	GND	Grounding*

Date of issue 06/13/2005

Wiring as sink

In the case of an operation as sink, the 26-pin connector is wired as follows:

Pin	Description	Function
2	CLOUT+	Current loop output (+)
4	CLOUT-	Current loop output (-)
3	CLIN+	Current loop input (+)
5	CLIN-	Current loop input (-)

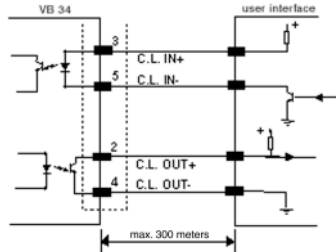

Figure 6.16 20 mA current loop, wiring as sink (passive)

If the VB34 reader is connected to a C-BOX 100 via a CAB-61X0, the signals are connected to the following terminals of the C-BOX 100:

Pin	Description	Function
11, 15	CLOUT+	Current loop output (+)
12, 16	CLOUT-	Current loop output (-)
17	CLIN+	Current loop input (+)
18	CLIN-	Current loop input (-)

Secondary interface

The secondary serial interface is designed as a fixed RS232 full-duplex interface. The interface is configured using the configuration software.

In full-duplex operation, the RS232 interface uses the following pins of the 25-pin or 26-pin connector:

Pin	Description	Function
20	RXAUX	Received data
21	TXAUX	Transmitted data
23	SGND AUX	Signal ground
5		

Barcode reader VB34 Installation

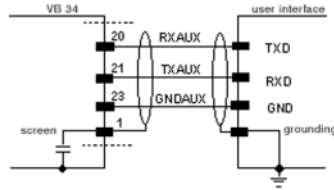

Figure 6.17 Connection layout of the RS232 interface

Inputs

The inputs of the reader are lead through on the 25-pin or 26-pin connector (Figure 6.11) of the VB34.

The inputs are labelled EXT_TRIG, IN2, IN3 and IN4.

Pin	Description	Function
18	EXT_TRIG A	External trigger (polarity exchangeable)
19	EXT_TRIG B	External trigger (polarity exchangeable)
6	IN2A	Input signal 2 (polarity exchangeable)
10	IN2B	Input signal 2 (polarity exchangeable)
14	IN3A	Input signal 3 (polarity exchangeable)
15	IN4A	Input signal 4 (polarity exchangeable)
24	IN_REF	Common reference earth for IN3 and IN4 (polarity exchangeable)

IN2 is normally used as encoder input. In the PackTrack™ operating mode, this input is used to measure the speed of the band.

EXT_TRIG is the primary presence sensor. An active signal at this input informs the reader that a code is to be read and decoded. A (yellow) LED indicates that the EXT_TRIG signal is active.

IN3 and IN4 can be used as stop signal for the read cycle.

All inputs are galvanically isolated by means of optocouplers, independent of polarity and are supplied via a constant current generator. The control signal is lead via a debounce filter with a delay of 5 ms or 500 ms. EXT_TRIG, IN3 and IN4 work with the same filter constant, which is usually set to 5 ms for photo cells, whereas IN2 is operated with a filter constant of 500 ms if an encoder is connected.

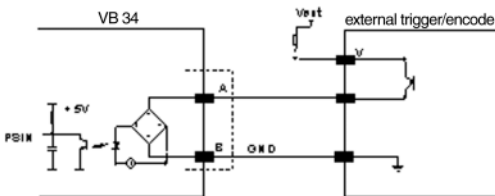

Figure 6.18 Input wiring with control via PNP signal

Date of issue 06/13/2005

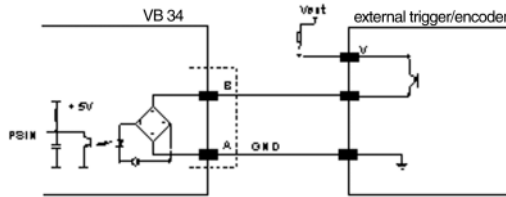

Figure 6.19 Input wiring with control via PNP signal

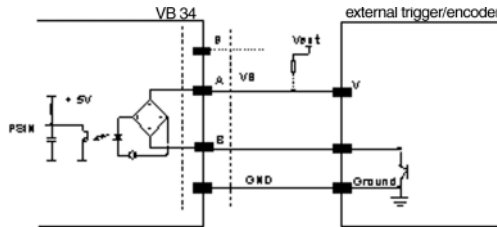

Figure 6.20 Input wiring with control via NPN signal

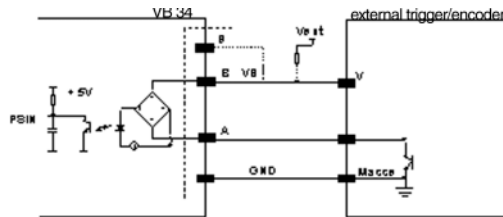

Figure 6.21 Input wiring with control via NPN signal

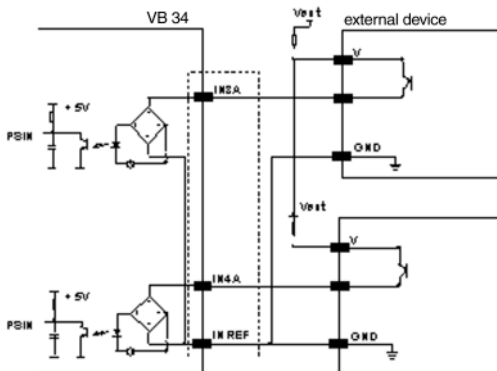

Figure 6.22 Input wiring with control via PNP signals

Barcode reader VB34 Installation

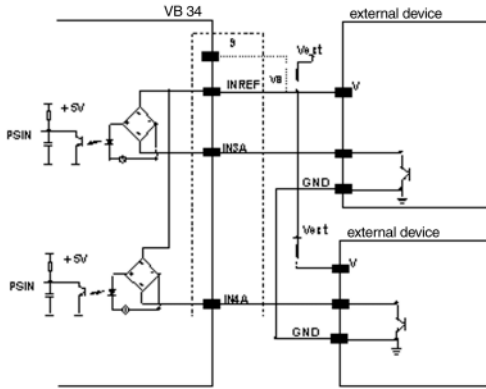

Figure 6.23 Input wiring with control via NPN signals

The inputs can be powered via the VS signal of the reader (pin 9).

For a galvanic isolation of control and reader, however, a supply with external voltage (Vext) instead of the voltage connected to pin 9 of the 25/26-pin connector is required.

For reasons of simplicity, the control logic for the input signals can be powered via the supply voltage of the reader, which is connected to the pins A (VS) and B (GND) of the connector. In this case, however, there is no galvanic isolation.

The voltage on pins A and B of the input connector is identical to the supply voltage of the scanner.

The characteristic values of these inputs are:

Maximum voltage	30 V
Maximum current	10 mA

Outputs

Three outputs are available:

Pin	Description	Function
8	Out 1+	Plus lead of the digital output 1
22	Out 1-	Minus lead of the digital output 1
11	Out 2+	Plus lead of the digital output 2
12	Out 2-	Minus lead of the digital output 2
16	Out 3A	Digital output 3 - polarity exchangeable
17	Out 3B	Digital output 3 - polarity exchangeable

The function of the three outputs OUT1+, OUT2+ and OUT3+ can be defined by the user.

Please refer to the online help for further information.

In the default setting, OUT1+ is connected with the COMPLETE READ event, which activates the output after a code has been read correctly. If the reader was programmed to read multiple codes in a read cycle, the event is triggered and the output is activated after all codes have been read.

Date of issue 06/13/2005

OUT2+ is linked with the NO READ event, which indicates that no code has been read.

OUT3+ is linked with the NONE event, i.e. no event. This means that the output always maintains its status.

The characteristic electrical values of the outputs OUT1+ and OUT2+ are:

Maximum collector-emitter voltage	30 V
Maximum collector current	130 mA
Saturation voltage(VCE)	1 V at 10 mA max.
Maximum power loss	90 mW at $T_U = 50^\circ\text{C}$

The limit defined by the maximum power loss is more important than the limit defined by the maximum collector current: if one of these outputs is continuously deactivated, the maximum current must not exceed 40 mA, even if up to 130 mA is permissible for pulsed operation.

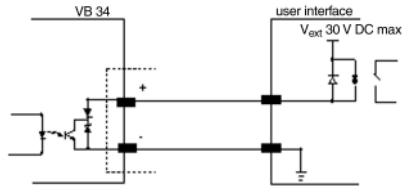

Figure 6.24 Connection layout of output 1 and output 2

OUT3+ is designed as a bidirectionally semiconductor relay with integrated current limit and has thus different characteristic electrical values. At an ambient temperature of 25°C , the maximum current through this output in continuous operation must not exceed 200 mA, in pulsed operating, up to 300 mA is permissible. At a maximum ambient temperature of 50°C , the maximum current is reduced to 160 mA (continuous) and 240 mA (pulse).

The characteristic electrical values of OUT3+ are as follows:

Maximum voltage	100 V
Maximum collector current (pulse)	240 mA
R_{on}	6 – 15 Ohm
R_{off}	> 500 Ohm
Leakage current in Off status	< 1 μA
Maximum power loss	550 mW in $T_U = 50^\circ\text{C}$

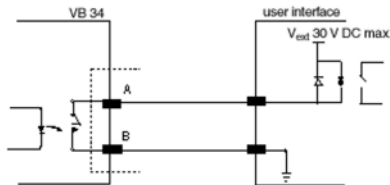

Figure 6.25 Connection layout of output 3

The control signal runs through a filter with a delay of 50 μs for OUT1+ and OUT2+

Barcode reader VB34

Installation

as well as for 1 ms for OUT3+.

If the load is powered by an external voltage supply, the voltage must be less than 30 V.

6.3.2 Lonworks connector

The network used by VB34 is based upon a Lonworks communication system, for which only two leads (with exchangeable polarity) are required for a connection. Furthermore, the supply voltage is lead through to the connectors. In this way, all the slave readers can be supplied via the VISOLUX standard cable by the master.

For applications, in which an increased range of functions is required for synchronization, the VB34 master issues two system signals with the descriptions Sys_I/O and Sys_Enc_I/O to the slave devices. If, for example, an application works with an encoder, the signal is received by the master and transmitted via the cable directly to all slave devices.

The internal circuits, which generate the system signals, are powered externally via the pins VS_I/O and REF_I/O and are galvanically isolated from the voltage supply of the reader.

These system circuits do not have to be used in all operating modes (see section 1.7 for additional information). To ensure that the system works without errors, only original cables and accessories should be used. The wiring must be in accordance with the example configurations (see section 1.7 for details).

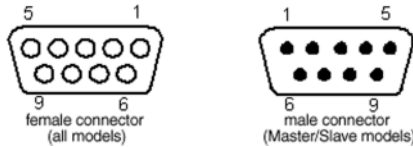

Figure 6.26 9-pin local Lonworks connectors

VB34 electrical connections of the 9-pin Lonworks connectors		
Pin	Description	Function
1	Shield	Shielding of the cable
9	VS	Supply voltage - plus
2	GND	Supply voltage - minus (ground)
6	VS_I/O	Supply voltage of the I/O circuit
3	Ref_I/O	Reference voltage of the I/O circuit
4	SYS_ENC_I/O	System signal
5	SYS_I/O	System signal
7	LON A	Lonworks lead (polarity exchangeable)
8	LON B	Lonworks lead (polarity exchangeable)

Date of issue 06/13/2005

Network termination

When constructing a Lonworks system, it is important to terminate the network correctly. For this, a BTK-6000 termination network is connected to the VB34 master reader as well as to the last VB34 slave reader.

This termination network is equipped with two connectors and can be connected to the 9-pin connector of the master or to the 9-pin socket of the last slave reader.

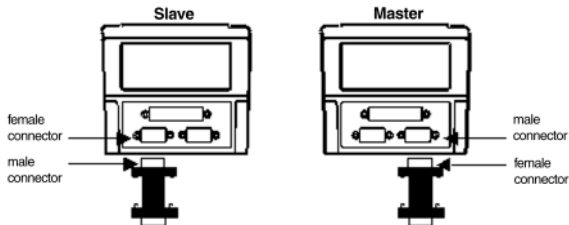

Figure 6.27 BTK-6000 termination network



For fieldbus models no external termination is required for the reader as this is already integrated.

Lonworks Interface

The Lonworks network consists of readers with input and output, which can be connected to a multiple side or station-wide system.

Generally, the VB34 master uses the 9-pin socket as the output to the first slave reader, while the 9-pin connector is completed with a BTK6000 termination network (see Chapter 6.7.2 for details). With a T network configuration, both connector plugs of the master are used for the two lead branches to the slave readers.

Both connections are always used to connect slave readers. For this purpose, the 9-pin socket is used as the output and the 9-pin connector is used as the input. The socket on the last reader is terminated to complete the network.

The following figure shows the connection of a VB34 as the master with a VB34 as the slave reader.

Barcode reader VB34 Installation

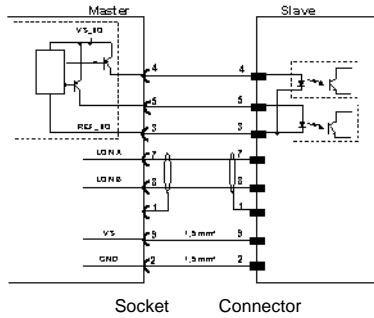

Figure 6.28 VB34 master/slave Lonworks connection



The maximum current consumption of a slave reader via the master is 2 A. Therefore, it makes sense to supply at the most 3 readers (master + 2 slave devices) with a 24 V power pack.

The following figure shows the two network connections of the BTK-6000. In the figures, the termination is shown as T. The following figure shows the switching of the termination network.

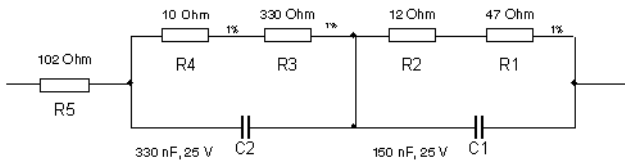

Figure 6.29 Circuit diagram of the BTK-6000 termination network

The following figure shows the termination of a VB34 operated as the master with a BTK-6000 termination network.

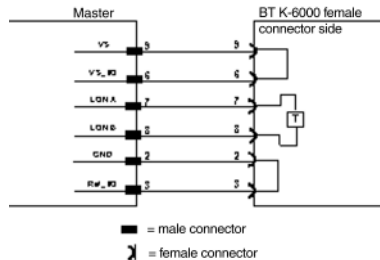

Figure 6.30 Termination of a VB34 master

The following figure shows the termination of a VB34 operated as the slave with a BTK-6000 termination network.

Date of issue 06/13/2005

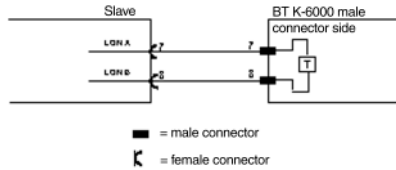

Figure 6.31 Termination of a VB34 slave

The following figure shows the connection of a VB34 fieldbus model, which always acts as the master, with a VB34 reader operated as the slave.

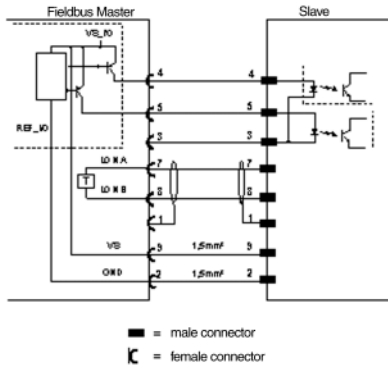

Figure 6.32 VB34 master/slave Lonworks connection

6.3.3 Ethernet connector

This connector is only available with VB34 Ethernet models and allows for an Ethernet connection between the host and the reader.

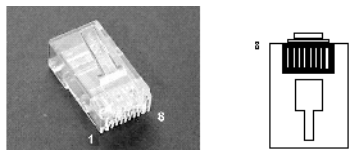

Figure 6.33 RJ45 cable connector

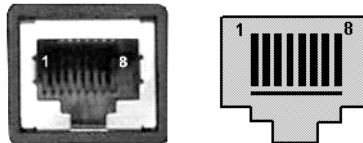

Figure 6.34 VB34 RJ45 socket

Connector and electrical connections (see the following table) correspond to IEEE 802.3 10 BaseT and IEEE 802.3U 100 BaseTx.

Barcode reader VB34 Installation

VB34 electrical connections of the RJ45 socket		
Pin	Description	Function
1	TX +	Transmitted data (+)
2	TX -	Transmitted data (-)
3	RX +	Received data (+)
6	RX -	Received data (-)
4, 5, 7, 8	N.C.	unoccupied

Ethernet interface

The Ethernet interface (NIC) can be used for the TCP/IP-based communication with external or local computers in a network or for the direct connection of a PC to the reader.

The following example shows the network connection via a hub with an uncrossed cable (standard network cable) :

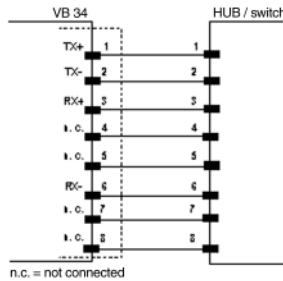

Figure 6.35 *Uncrossed cable*

The following example shows the direct connection of the reader to a PC with a crossover cable:

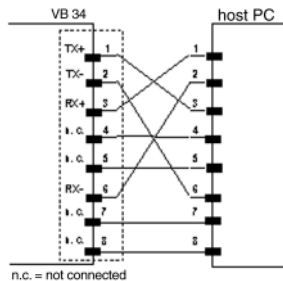

Figure 6.36 *Crossover cable*

For additional information, refer to document "Ethernet.pdf", which is available as additional documentation.

6.3.4 DeviceNet connector



When the DeviceNet is used, the primary serial interface is deactivated and must not be interfaced with another device.

The 5-pin connector is only available with the DeviceNet model of the VB34 and allows for a connection between the reader and a higher-level system:

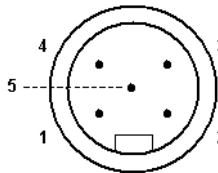

Figure 6.37 5-pin DeviceNet connector

VB34 electrical connections of the 5-pin DeviceNet connector		
Pin	Description	Function
2	V +	Supply voltage - plus
5	CAN_L	CAN bus data lead – L
1	Shield	Shield
4	CAN_H	CAN bus data lead – H
3	V -	Supply voltage - minus



The supply voltage to the pins V+ and V- is only used to supply the part of the DeviceNet card, which is directly connected to the bus. It is galvanically isolated from the supply of the VB34, which has to be connected to the pins 9 and 13 as well as 23 and 25 of the 26-pin connector.

6.3.5 Profibus connector

The 9-pin Profibus socket is only available with the Profibus model of the VB34 and allows for a connection between the reader and a higher-level system:

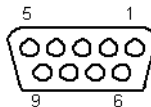

Figure 6.38 9-pin Profibus socket

Barcode reader VB34 Installation

VB34 electrical connections of the 9-pin Profibus socket		
Pin	Description	Function
1	Shield*	Shield or protective earth
2	-	unoccupied
3	B-LINE (RXD/TXD-P)	Received / transmitted data P
4	CNTR-P**	Repeater control signal
5	DGND	Signal ground (M5V)
6	+5 V	5 V voltage plus (P5V)
7	-	unoccupied
8	A-LINE (RXD/TXD-N)	Received / transmitted data
9	CNTR-N**	Repeater control signal

* optional
 ** optional, RS485 level

Profibus interface

The Profibus interface is used for communication with a higher-level system and allows for an extended network and remote diagnosis functionality of the reader.

For additional information, refer to the document “Profibus_Fam6k.pdf”, which is available as additional documentation.

6.3.6 Voltage supply

The supply voltage of an individual reader must lie between 15 and 30 V DC.

In master/slave configurations, VISOLUX recommends a voltage supply with at least 24 V DC.

The power consumption of the different VB34 models is slightly different.

When several VB34 readers are connected in a master/slave configuration, the maximum power consumption per reader is 15 W. Starting the motor results in a peak demand of approx. 20 W for 5 to 10 seconds.

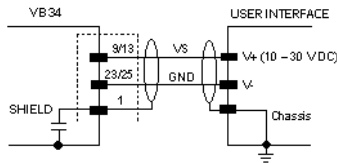

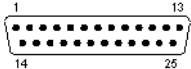

Figure 6.39 Voltage supply via the 25-/26-pin connector

Date of issue 06/13/2005

6.4 Operator interface

RS232 connection assignment to the PC			
 9-pin connector		 25-pin connector	
Pin	Description	Pin	Description
2	RX	3	RX
3	TX	2	TX
5	GND	7	GND
7	RTS	4	RTS
8	CTS	5	CTS

How to set up a simple test cable:

The following figure shows a simple test cable with supply, an external trigger (push button) and the connection of the RS232 interface to a PC.

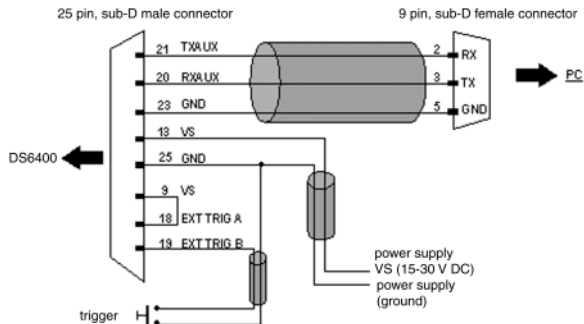

Figure 6.40 VB34 test cable

6.5 Adjusting the reader

The VB34 reader is able to read labels at most angles, however, a strong distortion can have an unfavourable effect on reading performance.

When assembling the VB34, note the following three ideal angles for the label position:

Tilt angle 0°, angle of rotation 10° to 30° and rotation 0°.

Follow the proposals in the next paragraph how best to position the reader:

The **tilt angle** is represented by the value **P**, see figure 41. Adjust the reader in such a way that the tilt angle is held as low as possible.

Barcode reader VB34 Installation

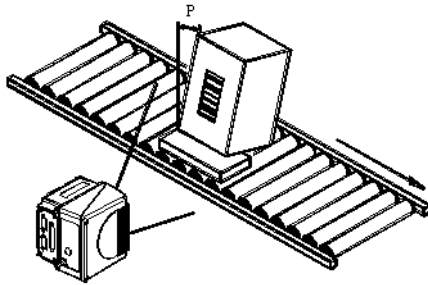

Figure 6.41 Tilt angle

The **angle of rotation** is represented by the value **S**, see figure 42. Adjust the reader in such a way that the **angle of rotation** is **at least 10°**. This prevents a direct reflection of the laser beam emitted by the reader.

With oscillating mirror models, this angle mirrors the smallest deflection or the scanning line that is closest to the horizontal. All other scanning lines have an **angle of rotation** of more than 10°.

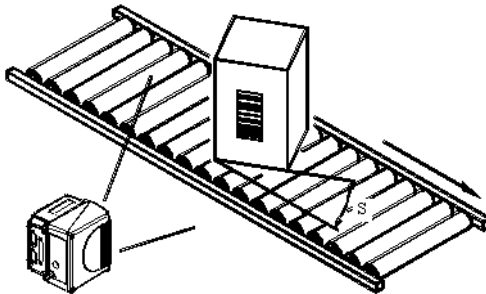

Figure 6.42 Angle of rotation

The **tilt angle** is represented by the value **T**, see Figure 6.43.

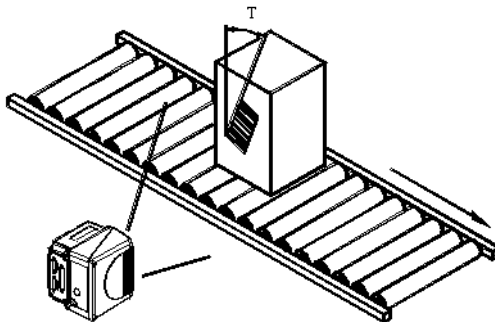

Figure 6.43 Tilt angle

Date of issue 06/13/2005

6.6 Typical installations

6.6.1 Standard installation

The VB34 reader is fitted on a ST-237 mounting angle with 105° (see figure 4), which ensures an angle of rotation (S in the following figure) of 15° to the level of the image. (Generally, the angle of rotation should lie between 10° and 20°.) This prevents a direct reflection of the laser beam emitted by the reader. Furthermore, the mounting angle allows for an adjustment of the tilt angle (T in the following figure, generally 0°) for an optimum alignment of the reader:

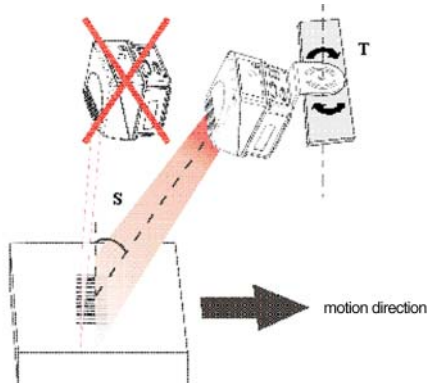

Figure 6.44 Standard installation

6.6.2 Installation with an angle of rotation of 45°

The VB34 reader is fixed with a ST-210 90° mounting angle (Figure 6.6). Adjust the guides of the mounting angle in such a way that an angle of rotation (S in the following figure) 45° is achieved in order to avoid a direct reflection from the laser beam emanated from the reader.

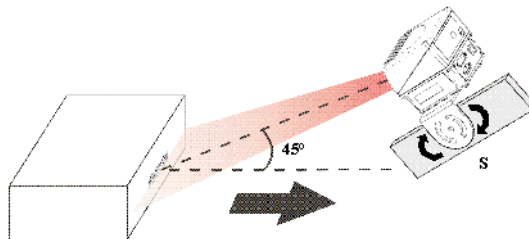

Figure 6.45 Installation with an angle of rotation of 45°

Barcode reader VB34 Installation



With the installation with an angle of rotation of 45° it is not ensured that the reader will achieve the same efficiency (see reading fields in Figure 8.3.1) as in the standard installation with angles of rotation between 10° and 20°.



The mounting angle ST-210 is contained as an accessory for the VB34 standard model in the US-60 set.

6.7 Typical hardware configurations

The following sections show typical examples for the system hardware configurations, for which a corresponding software configuration is required. For more detailed information, please refer to Chapter 7.2.

For other hardware configurations, a VB34 reader with a special decoder base assembly may be required.

The illustrated cable and accessories are original products. To ensure the functional capability and smooth operability of the system, it is recommended that you only use these products.

6.7.1 Point-to-point

In a point-to-point arrangement, the data is transmitted both via the primary and secondary interface. The primary interface can be adjusted to the full-duplex communication in accordance with the RS232 or RS485 standard.

Depending on the VB34 model, various hardware configurations are possible.

Master/slave models

During online operation, the reader is activated by an external trigger (light barrier) when an object enters the reading zone. In the following example, the signal is created via a C-BOX 100 to the VB34 reader, which also supplies the system.

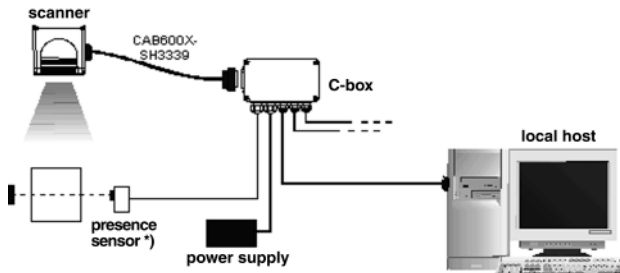

*) Presence sensor connected to the external trigger input.

Figure 6.46 Point-to-point arrangement for master/slave models

Fieldbus models

In this case, no external trigger is used. The C-BOX 100 is used only to supply the reader. The VB34 reader (as an Ethernet, DeviceNet or Profibus model) is connected to an external fieldbus host. It can be activated by a signal from the external host or always be active in automatic operation mode.

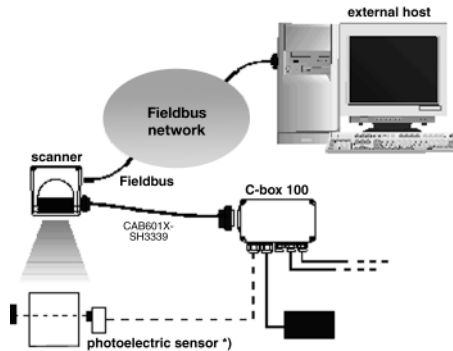

*) Light barrier (presence sensor) connected to the external trigger input .

Figure 6.47 Point-to-point arrangement for fieldbus models

6.7.2 Loops

With the loop arrangement via the secondary interface, all VB34 models can be integrated into a network with different readers, without the need for a Lonworks interface.

In this loop arrangement, two or more readers can be connected to a single external serial interface. Each VB34 reader also provides the messages, which it received on the secondary (RS232) interface, via the primary interface (also RS232).

In this arrangement, several readers can be switched in series. The message passes through all the stations in the chain up to the host. The read cycles of the individual readers are independent of those of the other readers. In loop configurations, each reader has an own external trigger (several light barriers).

For this purpose, a portable reader can also be included via the secondary serial interface in order to read codes manually.

The maximum cable length for RS232 connections is 15 m.

The following figure shows several VB34 readers in a loop arrangement.

Barcode reader VB34 Installation

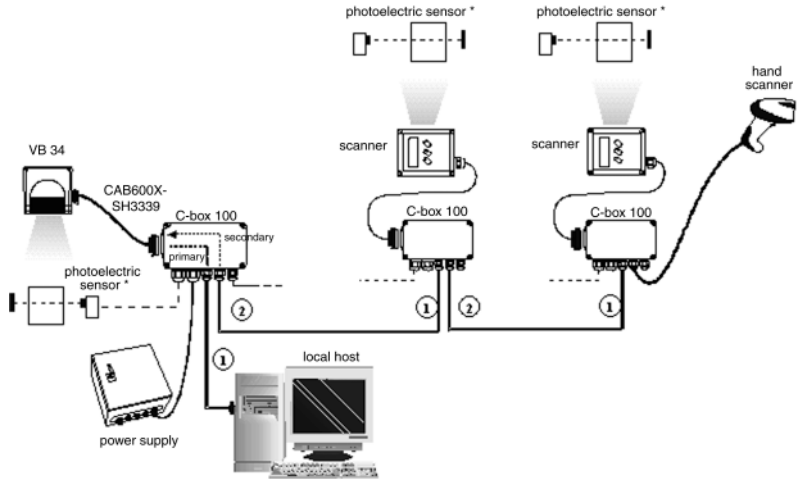

*) Light barrier (presence sensor) connected to the external trigger input .
Figure 6.48 Loop arrangement for VB34 master/slave models

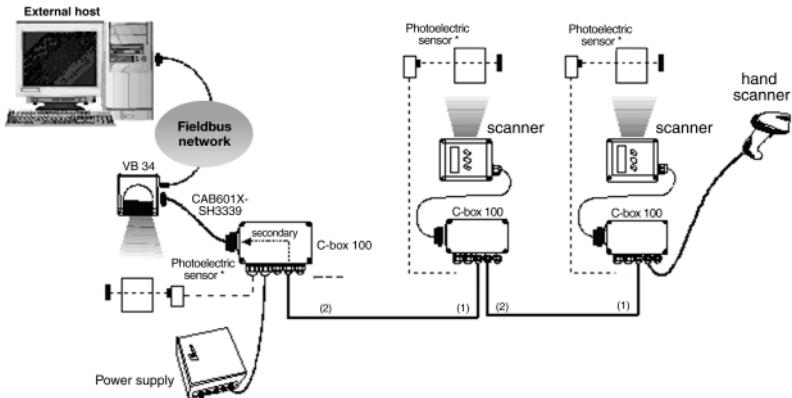

*) Light barrier (presence sensor) connected to the external trigger input .
 (1) Primary serial interface
 (2) Secondary serial interface
Figure 6.49 Loop arrangement for fieldbus models

6.7.3 RS232 master/slave

In the RS232 master/slave arrangement, all VB34 models can be integrated into a network with different readers, without the need for a Lonworks interface.

The readers operated as the slave only communicate via the primary and secondary RS232 interfaces. Each slave device also provides the messages, which it received on the secondary interface, via the primary interface. All messages are transmitted to the master.

The master reader is connected via the primary RS232 interface and a C-BOX 100 to a computer. If the INT-60 accessory option is installed, a 20 mA current loop can be used.

For the RS232 master/slave arrangement, a central external trigger signal is used (a light barrier).



Note

The **VB34 reader** (master/slave variant only), which is used as the master in a RS232 network, can simultaneously be connected to a Lonworks network with VB34 slave readers. When assigning slave addresses, note that the number of the first Lonworks slave must follow on seamlessly to the number of the last slave reader in the RS232 network. If, for example, the RS232 network consists of the devices slave 1 and slave 2, the first slave device in the Lonworks network is slave 3 (not slave 1).

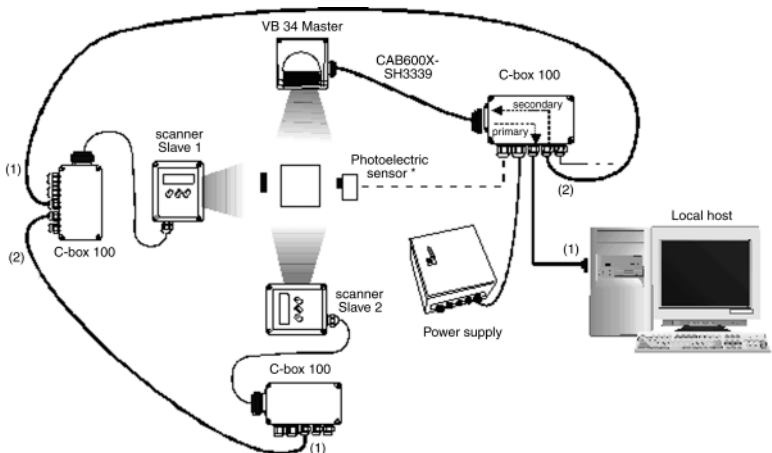

*) Light barrier (presence sensor) connected to the external trigger input .

(1) Primary serial interface

(2) Secondary serial interface

Figure 6.50 RS232 master/slave for VB34 master/slave models

Barcode reader VB34 Installation

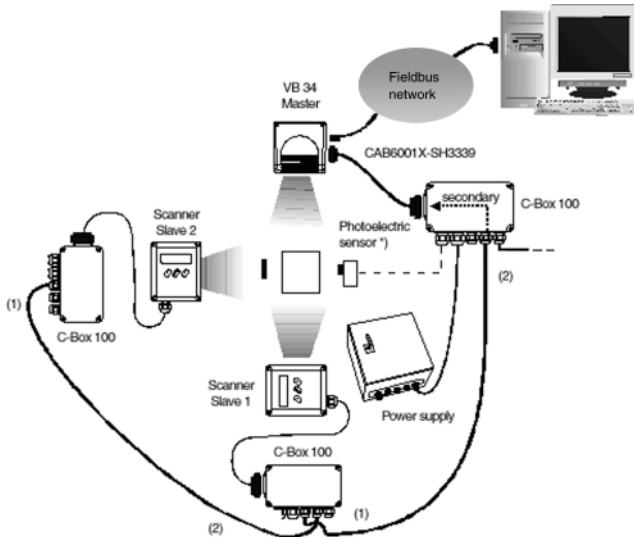

*) Light barrier (presence sensor) connected to the external trigger input .

(1) Primary serial interface

(2) Secondary serial interface

Figure 6.51 RS232 master/slave for VB34 master/slave fieldbus models

6.7.4 Multiplexer

The Multiplexer layout serves to integrate VB34 slave readers into a Multidrop network, which consists of different readers without a Lonworks interface .

All the readers are connected via the primary interface to a Multiplexer.

In this instance, the primary interface is configured as the RS485 half duplex interface.

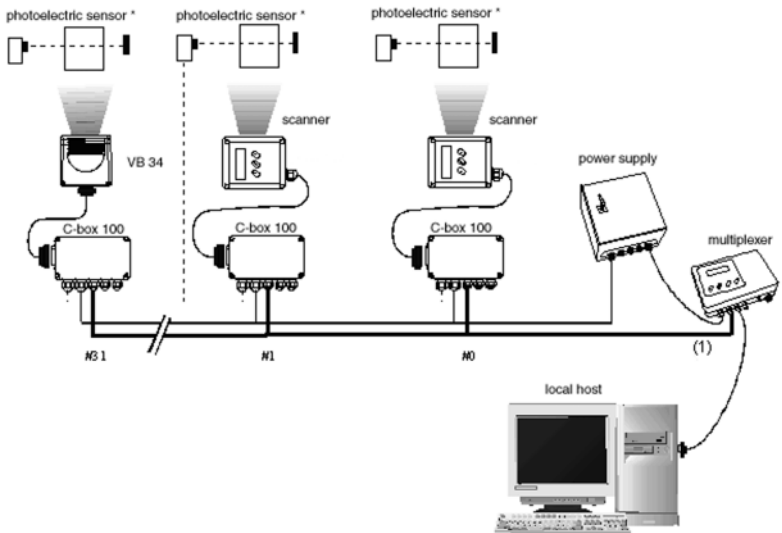

*) Light barrier (presence sensor) connected to the external trigger input .

(1) Primary serial interface

Figure 6.52 Multiplexer for VB34 master/slave models

The secondary serial interface of the slave readers can be used to visualize the entered data or to configure via the configuration software.

During online operation, the reader is activated by an external trigger (light barrier) when an object enters the reading zone.

6.7.5 Local Lonworks network

In a local Lonworks network, up to 31 VB34 slave devices can be connected to a VB34 master reader. In real terms, the number of readers that can be used in the network depends on the system operating conditions, especially on the operating mode and the volume of data. The online operating mode (for additional information, see the configuration software online help) supports, for example, a maximum of 8 slave readers.

With regard to the design of your network, always consider the following points:

- from an electrical point of view, the network supports up to 31 VB34 readers with a network length of 130 m.
- the maximum number of supported VB34 readers depends on how the system components are supplied. (For additional information, refer to Chapter 6.3.6.)

Contact VISOLUX if you have to integrate a large number of readers into your network or if the data throughput in the application is extremely high.

When you construct the network, the VB34 master reader must be connected via the 25-pin Sub-D connector to a local computer or to C-BOX 100.

The first slave reader of the system is connected to the 9-pin Lonworks socket of the master, while the 9-pin Lonworks connector must be completed with a BTK-6000 termination network.

Barcode reader VB34 Installation

The slave readers are connected together via the Lonworks connector plug. The network must be completed with a BTK-6000 termination network on the 9-pin socket of the last slave reader.

Central light barrier

The presence sensor is connected to the C-BOX 100 and is used as the sole, central trigger source in the system. There is only one read cycle with a message from the master reader to the local host. The online operating mode is used in this layout.

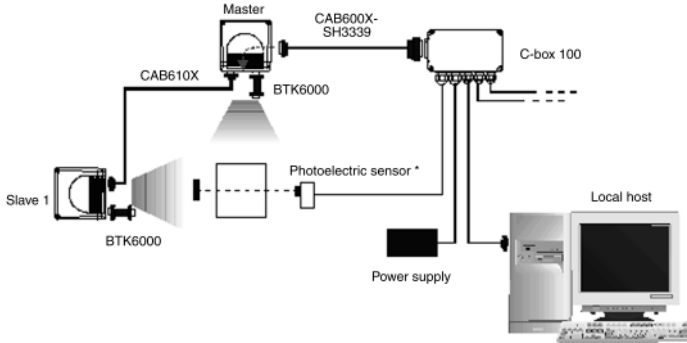

*) Presence sensor connected to the external trigger input.

Figure 6.53 Central light barrier with 2 readers

The following figure shows a system with four readers, which are supplied via two power packs. The master reader receives the external signals (triggers, serial host signals, etc.) and is supplied together with slave 1 by the first power pack via a C-BOX 100, while slave 2 and slave 3 are connected via a C-BOX 100 and the CAB610X cable to a second power pack. Each power pack supplies up to 2 readers. The CAB611X cable connects two separate groups: master and slave 1 as well as slave 2 and slave 3. In this instance, the voltage supply is not continued, only the network and synchronization signals are continued.

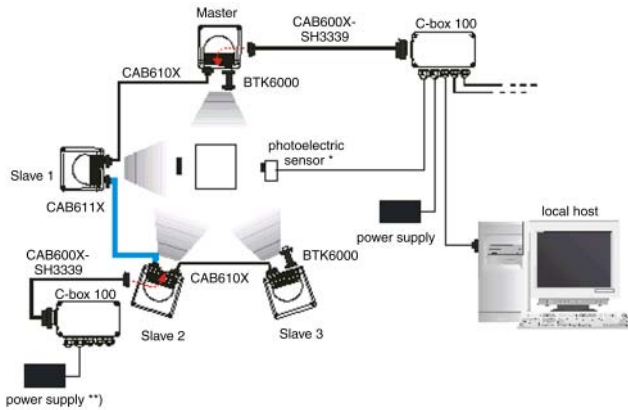

*) Light barrier (presence sensor) connected to the external trigger input .

**) The power pack can be connected directly via a separate cable to slave 2
(2 wires with at least 0,5 mm² for VS + GND).

Figure 6.54 Central light barrier with more than 2 readers and several power packs

The following figure shows a system with five readers, in which the master reader receives the external signals (triggers, serial host signals, etc.) and is supplied together with slave 1 and slave 2 via a C-BOX 100, while slave 3 and slave 4 are connected via a CAB610X cable to a second power pack. This is necessary because the C-BOX 100 can supply a maximum of 3 readers. The CAB611X cable connects two separate groups: master, slave 1 and slave 2 as well as slave 3 and slave 4. In this instance, the voltage supply is not continued, only the network and synchronization signals are continued.

Slave 3 is connected via a customer-specific, 2-wire cable (0,5 mm²) to the power pack (VS + GND).

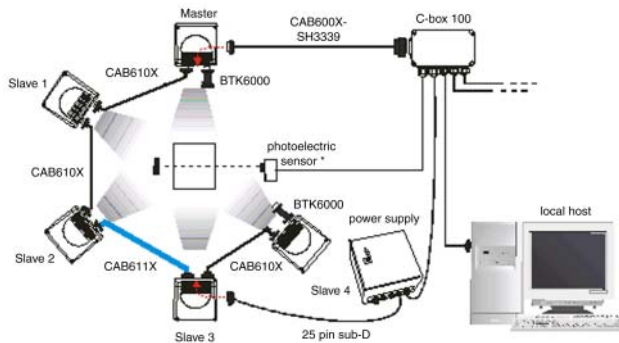

*) Light barrier (presence sensor) connected to the external trigger input .

Figure 6.55 Central light barrier with more than 2 readers and central voltage supply

Barcode reader VB34 Installation

Multiple light barrier (configuration available shortly).

In this layout, up to 7 VB34 slave readers each have a separate light barrier and thus several read cycles. The light barrier, which controls the master reader, is connected via the C-BOX 100.

The master transmits all the messages received via the Multidrop lead as well as its own messages to the C-BOX 100, which forwards them to the local host.

The following figure shows a system with four readers, in which the fourth reader is supplied via a separate C-BOX 100 because a C-BOX 100 can supply a maximum of 3 readers. Therefore, the cable connecting the two separate groups does not carry over the supply. In this example, this is cable CAB611X between slave 2 and slave 3.

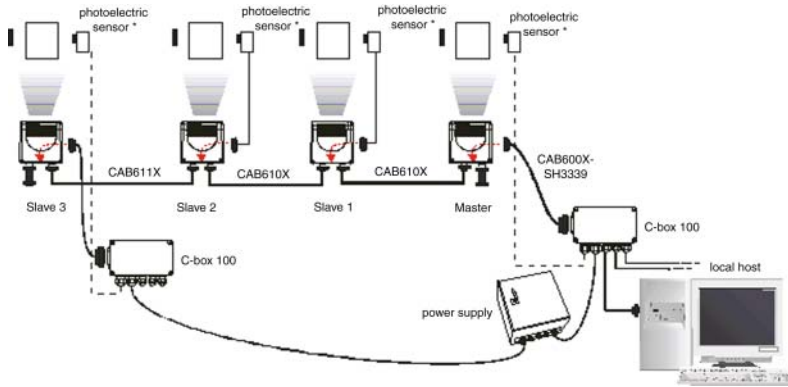

*) Light barrier (presence sensor) connected to the external trigger input .
Figure 6.56 Multiple light barrier with more than 3 readers

6.7.6 Fieldbus network

Fieldbus models (Ethernet, Profibus and DeviceNet) enable communication in fieldbus environments without a converter or adapter.

The VB34 fieldbus master communicates with the external host via a cable, which is connected to the fieldbus connector (Ethernet, Profibus or DeviceNet). This host can, for example, be an external PC with an IP address.

The 9-pin Lonworks socket is used to connect the first slave device to the master, while the 26 Sub-D connector is used to supply the master via a C-BOX 100.

The slave readers (VB34 master/slave models) are connected together via the Lonworks connector plug. The network must be completed with a BTK-6000 termination network on the 9-pin socket of the last slave reader. No termination network is required for the fieldbus master because the termination is already integrated.

Central light barrier

The VB34 master reader (as an Ethernet, DeviceNet or Profibus model) is connected to an external fieldbus host. It can be activated by a signal from the external host or always be active in automatic operation mode.

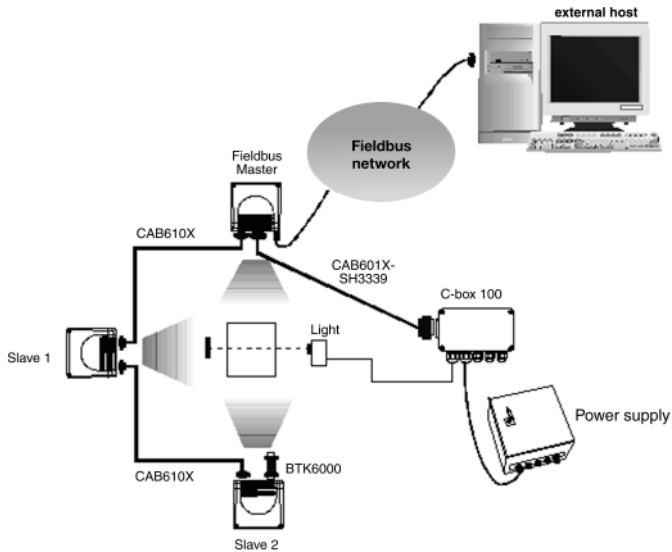

*) Light barrier (presence sensor) connected to the external trigger input .
Figure 6.57 Fieldbus layout with a central light barrier

As already described, a C-BOX 100 can supply a maximum of 3 readers. If more than 3 readers are used, connect the different groups with a CAB611X cable, which does not loop in the supply lines, and supply the individual groups separately.

6.8 FLASH™ dynamic focusing

An innovation of the VB34 is the linear motor, which can be used to control the reading position of the scanner via software. This dynamic system with the name Flash™ is able to assume any reading position from the minimum position to the maximum position.

The Flash™ function is programmed via the configuration software (see the online help for details) and has the following operating modes:

- Fixed adjustment
- Continuous adjustment
- Trigger operating mode
- D-Flash™ operating mode

6.8.1 Fixed adjustment

With fixed adjustment, the read distance (in cm/inch) is adjusted as fixed to the desired position per software. This is the most simple Flash™ function, during which the focus position is adjusted per software before use in the application and stored in the decoder of the reader. This function is similar to the focus adjustment of the VB33 reader, however, with the major difference that in terms of software the adjustment is made using the configuration program and not manually via an adjustment screw.

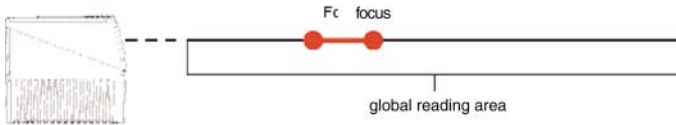

Figure 6.58 Flash™ fixed adjustment

6.8.2 Continuous adjustment

With continuous adjustment, the focus position is continuously adjusted with a defined frequency (f_1 in the following figure) between minimum and maximum. This Flash™ function makes it possible to use the entire read range of the VB34 if the objects to be recognized are large and move slowly. Typical areas of application for continuous adjustment are reading the front of large pallets or objects on a fork lift truck.

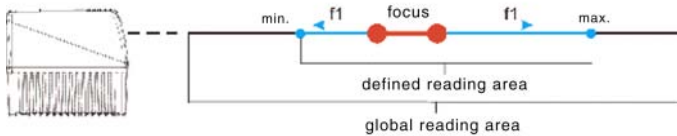

Figure 6.59 Flash™ continuous adjustment

6.8.3 Trigger operating mode

In the trigger operating mode, the focus position is adjusted depending on an external input signal (light barrier, message via the serial interface...). This is the traditional Flash™ function, for which light barriers or a separate interface to the host (PC or PLC) are required. The excellent capability of the VB34 optical system platform makes it possible to cover an area of 800 mm x 800 mm with a code resolution of 38 mm using only one light barrier.

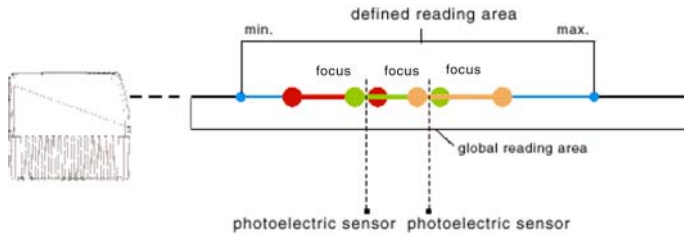

Figure 6.60 *Flash™ trigger operating mode*

6.8.4 D-Flash™ operating mode

In the D-Flash™ operating mode, the focus position is changed depending on the measured distance (D_n in the following figure) between the reader and the object to be read. This innovative and highly flexible function presents the software with extensive possibilities. The D-Flash™ development is based upon the measured minimum distance. This makes it suitable for a variety of applications. If necessary, D-Flash™ can be tailored to meet the requirements of a specific application and developed further.

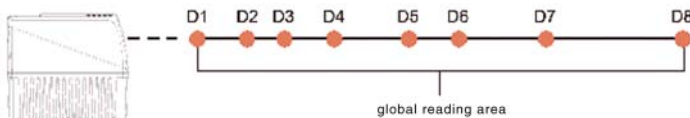

Figure 6.61 *Flash™ D-Flash™ operating mode*

6.9 Key field and display

The VB34 key field makes it possible to call a menu using the following functions:

- Internal Net
- Test mode

These adjustments can also be made via the configuration software. (For additional information, refer to Chapter 7.)

6.9.1 Internal Net

This sub menu is used to configure the VB34 reader in a master/slave network.

Here, the function of the reader (slave/master) in the network as well as, if configured as a slave, the address are defined.

To call the Internal Net sub menu and configure the reader, carry out the following steps:

1. Keep the keys ▲ (arrow up) and ▼ (arrow down) depressed for 2 seconds at the same time to call the main menu.
2. Press the key ▲ (arrow up) or ▼ (arrow down) to select the "Internal Net" menu option and press ENT (Enter) to call the option.
3. Press the keys ▲ (arrow up) or ▼ (arrow down) to select the "LonWAddrSel" menu option and press ENT (Enter) to call the option.
4. Select the reader function using the keys ▲ (arrow up) and ▼ (arrow down):

“MASTER” for master, “Slave n” for slave or “Disabled” for deactivated. Press the key ENT (Enter) to call the option.

5. Press the key ▲ (arrow up) or ▼ (arrow down) to select the “Exit” menu option and press ENT (Enter) to call the option. Repeat this step to exit the main menu and to return to the originally active operating mode of the reader.

6.9.2 Test mode

The test mode is very useful during the installation phase because the reader is activated to check the optical adjustments as well as the reading position of the barcodes.

To call the Test Mode sub menu and configure the reader, carry out the following steps:

1. Keep the keys ▲ (arrow up) and ▼ (arrow down) depressed for 2 seconds at the same time to call the main menu.
2. Press the key ▲ (arrow up) or ▼ (arrow down) to select the “Test Mode” menu option and press ENT (Enter) to call the option. The reader switches to test mode.
3. Press the key ▲ (arrow up) to exit the test mode.
4. Press the key ▲ (arrow up) or ▼ (arrow down) to select the “Exit” menu option and press ENT (Enter) to call the option. The reader exits the main menu and returns to the previous operating mode.

7 Software configuration

7.1 Software installation

The new configuration software offers a number of important special features:

- Assistant-based approach for less experienced users
- Multi-lingual version
- Defined configuration is stored directly in the reader.
- A communication protocol independent of the used interface allows for the hardware-independent treatment of the reader as an external object, which is configured and monitored.

To install the software, carry out the following steps:

1. Switch on the PC, on which the configuration software is to be used, and start Windows.
2. Insert the CD-ROM into the drive.
3. Wait until the installation program from the CD has started and then follow the installation procedure.

7.2 Hints on quick configuration

7.2.1 Assistant for quickly setting up the reader

After installing the configuration software (Chapter 7.1) the system displays the following window in which the user can select the desired configuration type:

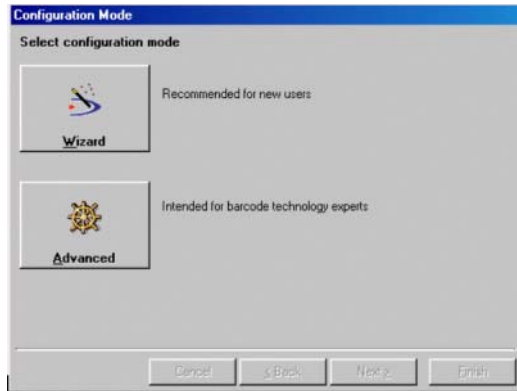

Figure 7.1 Start window for configuration program

Less experienced users should select the option "Wizard", where an Assistant will guide you step by step through the configuration of the reader. The following parameters must be defined:

- Selection and definition of the barcodes
- Selection and definition of the operating mode (for more information, see the following sections)
- Configuration of the digital inputs/outputs
- Selection of the hardware interface
- Configuration of the data output format

After the parameters have been defined, the system displays the following window for completing the configuration of the reader with the following options:

- Save configuration on disk
- Change to enhanced configuration
- Send configuration to the reader

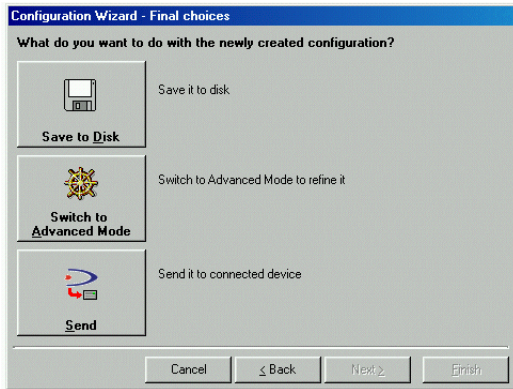

Figure 7.2 Completion window of the Configuration Assistant

Test operating mode

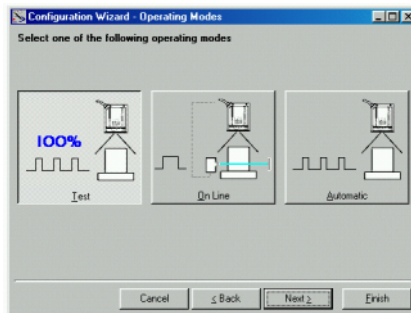

Figure 7.3 Selecting the test operating mode

In the test mode, the reader is continuously activated in order to check the optical adjustments as well as the reading position of the barcodes. This operating mode should be used during the installation phase of the reader.

After 100 read processes, the read data and an internal counter are displayed and output via the serial interface. The counter contains the percentage of the successful read processes.

Online operating mode

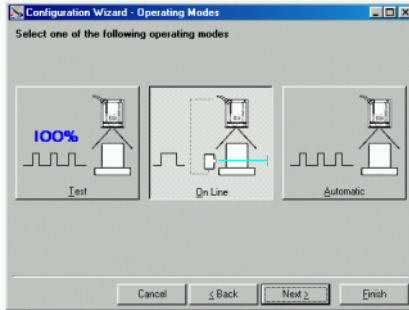

Figure 7.4 Selecting the online operating mode

This operating mode instructs the reader to evaluate the external presence sensor at the input EXT TRIG+ and EXT TRIG.

If the presence sensor is active, the VB34 reader attempts to enter and decode the code.

If the decoding cycle is completed successfully, the barcode data is transmitted via the serial interface. Otherwise, a message stating that no data was read is transmitted.

Automatic operating mode

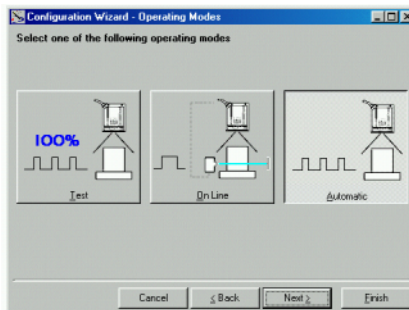

Figure 7.5 Selecting the automatic mode

No connection to an external presence sensor is required for this operating mode. In this operating mode, the reader scans automatically and activates the read cycle when a barcode enters the read zone of the reader. The reader stops after an adjustable number of empty scans.

The barcode data is transmitted via the serial Interface. If a read cycle is completed without a result, no message is transmitted to the computer.

Barcode reader VB34 Software configuration

7.2.2 Network Assistant

The Network Assistant allows you to define the models and number of slave readers in the Lonworks network.

The configuration software identifies the device type by means of a code number. The code number is displayed in the relevant device window.

The following code numbers are assigned to the device types:

Device type	Code number
VB33-2000-XX	DS6300-100-XXX
VB33-2000-OM-XX	DS6300-105-XXX
VB34-2500-XX	DS6400-100-XXX
VB34-2500-OM-XX	DS6400-105-XXX

Since this tool is only available for a VB34 master, your reader must first be configured as the master as shown in the following figure:

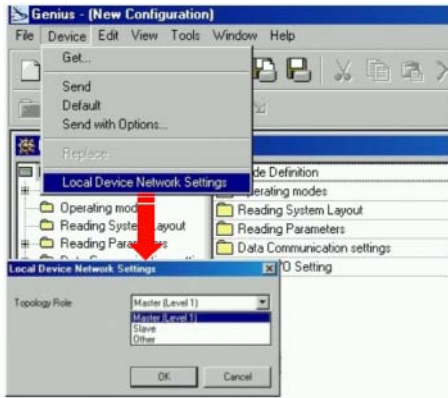



Figure 7.6 Network setting of the local device

After that, the network settings can be defined by starting the Network Assistant:

1. If the Assistant cannot be started, activate the cluster configuration by clicking the  symbol in the toolbar. After that, the “Devices” device window will appear next to the Explorer window parameter.

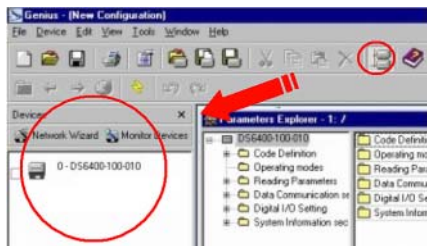



Figure 7.7 Cluster configuration

Date of issue 06/13/2005

- Click the  push button in the “Devices” device window in order to open the dialog field of the Network Assistant:

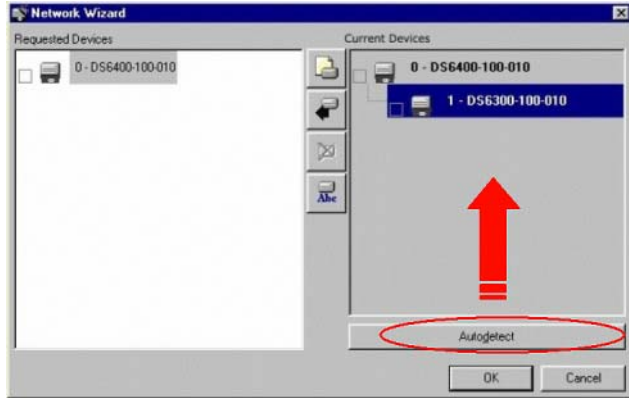





Figure 7.8 Network Assistant

- If the slave readers are already configured and wired with the network, click the autodetect button in order to start the network query. All the devices that were found are listed in the “Current Devices” area. From the “Current Devices” area, select the desired slave reader and click the  symbol in order to transfer the reader to the “Requested Devices” area in which you configure the network. You can also drag and store the device into this area by keeping the mouse button depressed.
 - If the slave readers have not yet been configured and connected to the network, click the  symbol in order to add a new device to the configuration. During this process, you also have to enter the model and device address. The slave reader you added will then appear in the “Current Devices” area.
- If you want, select the transferred/added slave readers in the “Requested Devices” area and click the  symbol in order to edit the description of the reader.
 - After your network has been configured, close the Network Assistant. Before closure, the program shows a dialog field containing the query whether you would like transmit the new configuration to the master. Select the option “Yes” in order to start this operation.

7.3 Enhanced configuration

The ADVANCED option at the start of the configuration program is directed at experienced users, who would like to configure the reader in all details without the Assistant. After selecting this option, you can create a new reader configuration or open or change an existing one. The parameters are defined in the following window, which contains an Explorer-like organization structure:

Barcode reader VB34 Software configuration

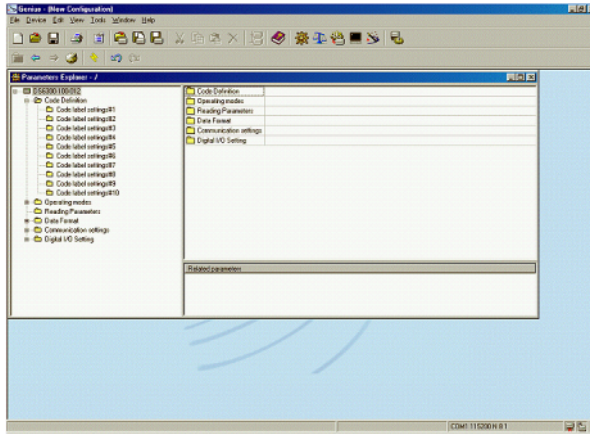

Figure 9 - Parameters in the Explorer window

If required, to help you make the setting, an Online help is available, which is represented in an HTML browser.

It is called via the configuration help option in the help menu. Furthermore, after selecting the desired parameter, a context-sensitive help is available via the <F1> key.

7.4 Basic settings for parameters

The following table describes the default settings for VB34.

The configuration software also allows the current parameter settings to be compared with the default settings. In the Tools menu, select the "Compare parameters" option in order to compare the current configuration with the default setting.

Parameters	Basic setting
Code definition	
Code combination	Single label
Message if read process without result	Global message if read process without result
String if read process without result	<CAN>
Label code settings no. 1	
Code symbology	Interleaved 2 from 5
Length of label	8
Minimum of code position	0
Maximum of code position	255
Check digit	Deactivated
Decoding complexity	3
Comparison string	Empty
Label code settings no. 2	
Code symbology	Code 39
Length of label	Variable
Minimum for label length	1
Maximum for label length	48
Minimum of code position	0
Maximum of code position	255
Check digit	Deactivated
Decoding complexity	3
Comparison string	Empty
Operating modes	
Operating mode selection	Online
Online options	Online input 1
Start input number	1
Active level for start input	Active when closed
Timeout for read cycle	Deactivated
Statistical data	Deactivated
Read system layout	
Device assignment	Independent
Read parameters	
Beam lock	Deactivated
Overflow relationship	7
Read operating mode	Reconstruction
<u>Reconstruction parameters</u>	
Max. scan gaps	5
Max. stack codes	1
<u>Scan lines amplitude</u>	
Release of amplitude setting	Deactivated

Barcode reader VB34

Software configuration

Parameters	Basic setting
<u>Flash</u>	
Flash operating mode	Deactivated
Data communication settings	
Host application protocol type	Standard
<u>Data format</u>	
Send start section	With data
Termination string after message with reading without results	Activated
Trigger selection for sending the message	After decoding
Parameters	
Opening text	<STX>
Code direction ID	Deactivated
Code ID	Deactivated
Termination string	<CR><LF>
Separators for data packets	<CR><LF>
Setting for code field length	Variable length
<u>Primary serial interface</u>	
Transmitted data	Activated
Parameters	
Communication type of primary interface	Standard
Interface standard of primary interface	RS232
Handshake	
Baud rate	
Parity	off
Data bits	9600
Stop bits	none
	8
	1
<u>Secondary serial interface</u>	
Transmitted data	Activated
Loop	Deactivated
Parameters	
Baud rate	115200
Parity	off
Data bits	8
Stop bits	1

Date of issue 06/13/2005

Parameters	Basic setting
Settings for digital inputs/outputs	
<u>Filter settings of digital inputs</u>	
Anti-disturbance hardware for inputs 1, 3 and 4	5 ms
Anti-disturbance hardware for input 2	500 µs
Operating mode has priority before active input 1	Active when closed
Operating mode has priority before active input 2	Active when closed
Operating mode has priority before active input 3	Active when closed
Operating mode has priority before active input 4	
<u>Output 1</u>	
Lead status	NC
Activating event	Reading completed
Alternative activating event	Repeated reading
Deactivating event	Timeout
Alternative deactivating event	off
Deactivating timeout (ms)	50
<u>Output 2</u>	
Lead status	NC
Activating event	Reading without result
Alternative activating event	Partial reading
Deactivating event	Timeout
Alternative deactivating event	off
Deactivating timeout (ms)	50
<u>Output 3</u>	
Lead status	NC
Activating event	off
Alternative activating event	off
Deactivating event	off
Alternative deactivating event	off

8 Optical properties

8.1 ACR technology (ACR™ 3 reconstruction)

The traditional method of reading barcodes can be described as “linear reading”. Under this method, the laser beam passes across the barcode symbol from the start to the end, as shown in the following figure:

Barcode reader VB34

Optical properties



Figure 8.1 Linear reading

With the ACR technology it is no longer necessary for the laser beam to pass across the entire barcode in one go. The VB34 is able to reconstruct the barcode from a series of partial scans, which are possible if the label itself is moving. The following figure shows a typical example of a series of partial scans:

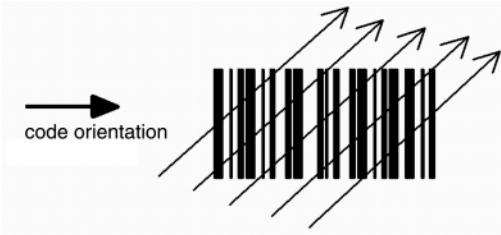

Figure 8.2 Partial scans

None of the partial scans contains the complete barcode. The decoder aligns the individual partial scans correctly to each other and combines them in the correct sequence thereby creating the complete code.

The partial scans are aligned using the time difference between the partial scans, which is calculated via reference elements in the code.

8.1.1 Tilt angle for the ACR reconstruction

The most important parameter in the detection with ACR technology is the maximum tilt angle (α_{max}), under which a code can still be reconstructed.

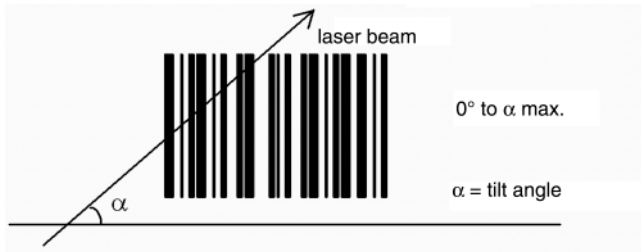

Figure 8.3 Rotation angle

The calculation of the maximum angle for a is affected by different parameters, such as: height of label, number of read processes per second, code motion speed, etc. To determine the maximum value for a in your application, get in touch with your Pepperl+Fuchs contact person.

Note that the decoder can read the label under a rotation angle between $+\alpha_{max}$ and

Date of issue 06/13/2005

$-\alpha_{\max}$ as shown in the following figure:

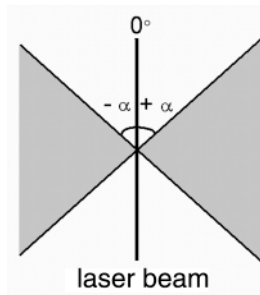

Figure 8.4 Read zone with α max

8.2 PackTrack™

PackTrack™ is a patented operating mode for position-independent read stations. It makes it possible to read and correctly assign codes on different objects, which exist in the reading zone of the reader at the same time.

For the PackTrack™ operating mode, an encoder and a presence sensor are required for tracking the moving targets.

The entire PackTrack™ functionality is programmed via the configuration software. (Please refer to the online help for further information.)

In the following example, the codes of two or more consecutive packets effectively lie in the reading zone at the same time. This results in a situation, in which the code of the second packet is read first, even before the code of the first packet. A system without PackTrack™ would assign the code of the second packet to the first packet and vice versa, thus causing a major sorting error.

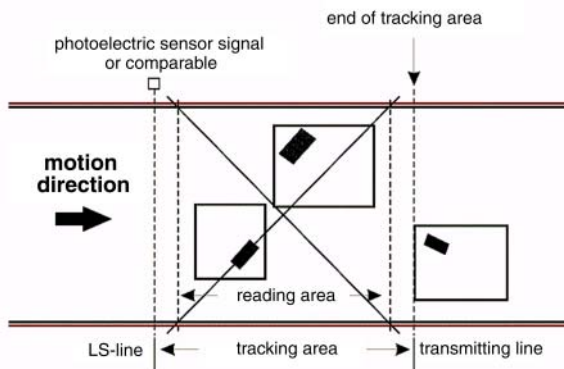

Figure 8.5 PackTrack™ system arrangement

To ensure the function works correctly, the PackTrack™ operating mode needs to be calibrated after the readers have been installed. This step is absolutely necessary for

Barcode reader VB34

Optical properties

the reader to be able to recognize its own spacial position. This makes a fixed reference system necessary.

The following figure shows this using a reference system which can be represented using the right hand (thumb = X axis, index finger = Y axis and middle finger = Z axis), where the Y axis corresponds with the direction of travel of the packets and the Z axis runs vertically to the conveyor belt upwards (see the following figure). Three barcodes are positioned in the scan line. Three coordinates are displayed for each of these barcodes. (The X axis corresponds with the light barrier line).

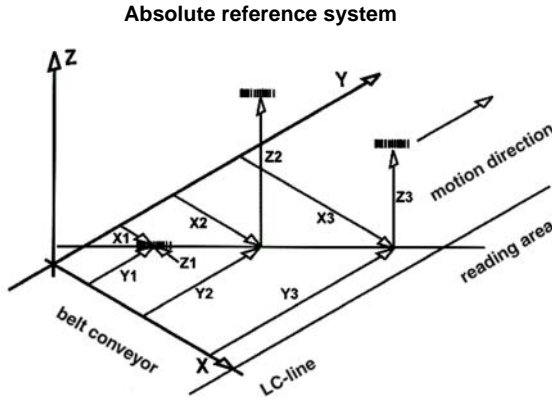

All the readers receive 5 pieces of information via each barcode position: x, Y and Z (entered by the user) as well as the position in the scan line and distance (measured from the reader)

Figure 8.6 PackTrack™ reference system

8.2.1 PackTrack™ calibration

The reader can be calibrated via the configuration™ software.

Select the “SPY” option from the Tools menu or click on the corresponding symbol in the configuration™ toolbar to show the following dialog field:

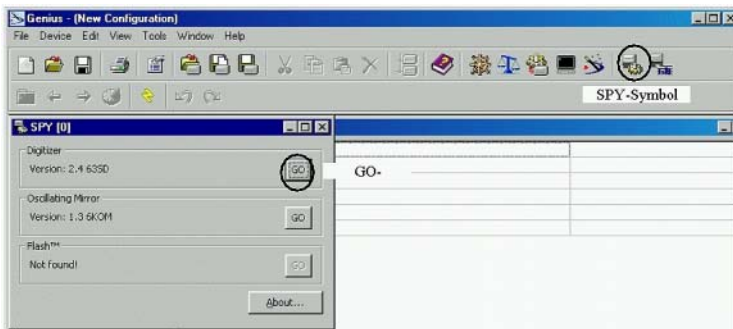

Figure 8.7 Opening the digitizer window

Date of issue 06/13/2005

Click the “GO” push button in the digitizer field to show the following window:

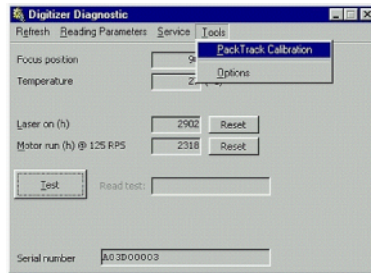

Figure 8.8 Selecting the PackTrack™ calibration

After selecting the “PackTrack Calibration” option in the Tools menu, another dialog field in which the calibration can be started will appear:

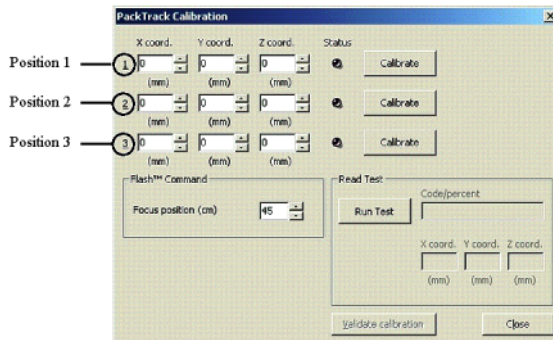

Figure 8.9 Executing the PackTrack™ calibration

After the code has been positioned to the desired position (position 1), enter the X, Y and Z code coordinates in the corresponding fields of the dialog field. Click the “Calibrate” push button to start the calibration.

Repeat this process for position 2 and position 3.

The “Focus position” field in the Flash™ command area makes it possible to adjust the focus position, while the “Run Test” push button makes it possible to test the calibration results and the efficiency.

Before closing the dialog field, click the “Validate Calibration” push button to adopt the calibration adjustments.

8.3 Read diagrams

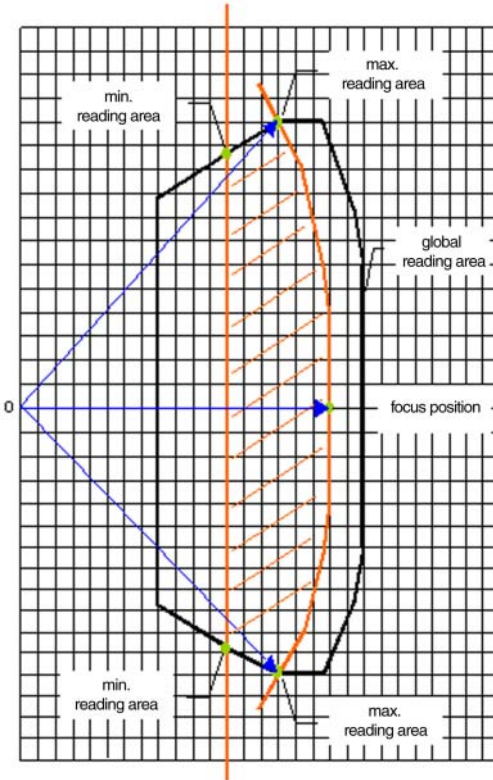

Figure 8.10 Calculating the reading zone

The read diagrams in the following figures clarify the conventions, which are used in the calculation of the minimum and maximum distances for reading barcodes. This procedure makes it possible to calculate the reading distance for your reader when using another focus adjustment than that specified in the read diagrams in Chapter 8.3.1 and Chapter 8.3.2 .

Mark the minimum focus position with a straight vertical line. The points of intersection between this line and the global reading zone give the minimum reading distance.

Mark the external outline of the global reading zone with the origin (0,0) and a radial distance, which is equal to the maximum work distance of the reader. The points of intersection between this outline and the global reading zone give the maximum reading distance.

8.3.1 VB34 standard model

VB34-2500 (standard), resolution: 0,20 mm (8 mils)

The diagram shows a global reading zone, which is practically the sum of all the possible focus positions, and the reading zone, which results for the VB34 from a focus position of 650 mm and a barcode density of 0,20 mm (8 mils).

The values for the maximum and the minimum distances are found in the radial distance curves in Figure 8.12.

Date of issue 06/13/2005

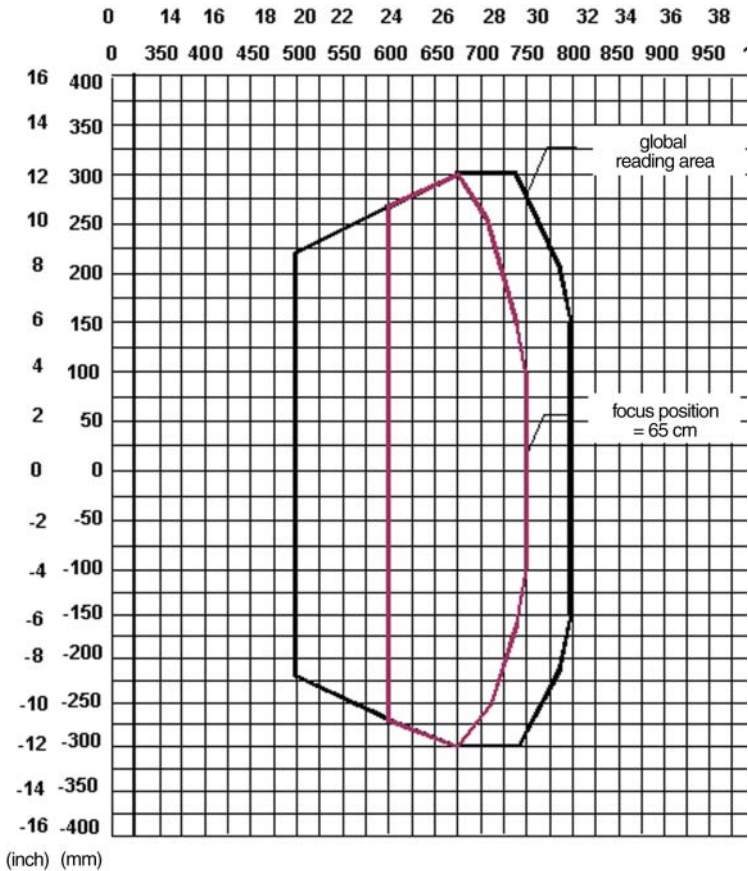

Figure 8.11 Read diagram of the standard model with 0,20 mm/8 mils

Remark: (0,0) is the central position of the laser exit window.

Conditions

Code = interleaved 2 from 5 or code 39

PC = 0,90

Tilt angle = 0°

Angle of rotation = 10° - 20°

Tilt = 0°

Barcode reader VB34

Optical properties

The curves show the minimum and maximum radial distances.

reading area

(inch) (mm)

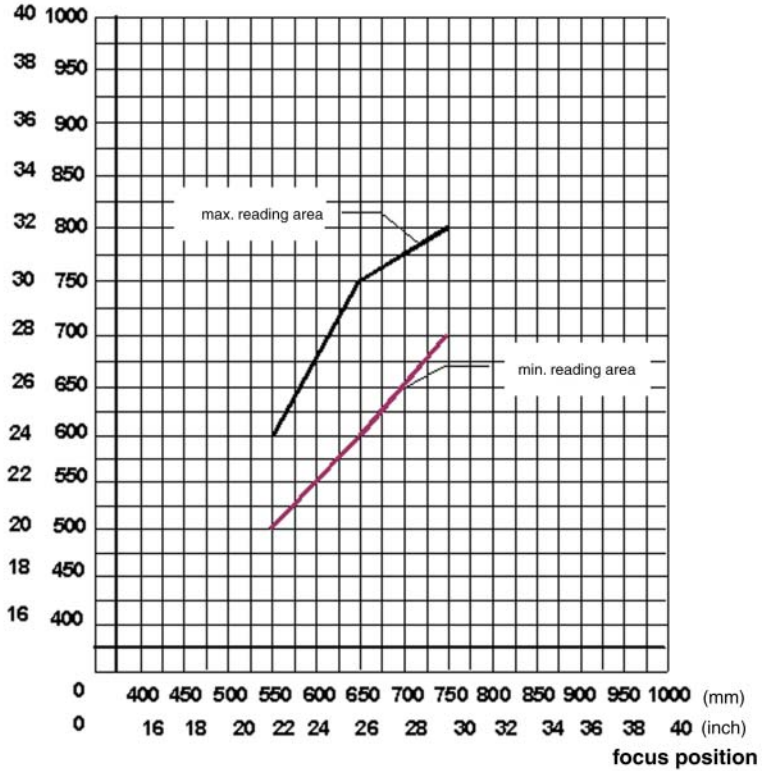

Figure 8.12 Radial distances for standard model with 0,20 mm/8 mils

VB34-2500 (standard), resolution: 0,25 mm (10 mils)

The diagram shows a global reading zone, which is practically the sum of all the possible focus positions, and the reading zone, which results for the VB34 from a focus position of 900 mm and a barcode density of 0,25 mm (10 mils).

The values for the maximum and the minimum distances are found in the radial distance curves in Figure 8.14.

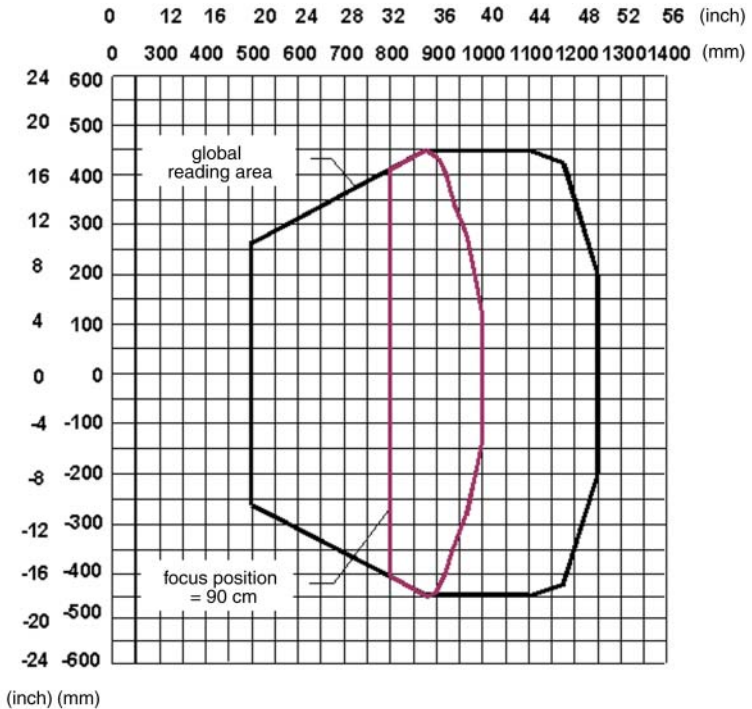

Figure 8.13 Read diagram of the standard model with 0,25 mm/10 mils

Remark: (0,0) is the central position of the laser release window.

Barcode reader VB34

Optical properties

Conditions

- Code = interleaved 2 from 5 or code 39
- PC = 0,90
- Tilt angle = 0°
- Angle of rotation = 10° - 20°
- Tilt = 0°

The curves show the minimum and maximum radial distances.

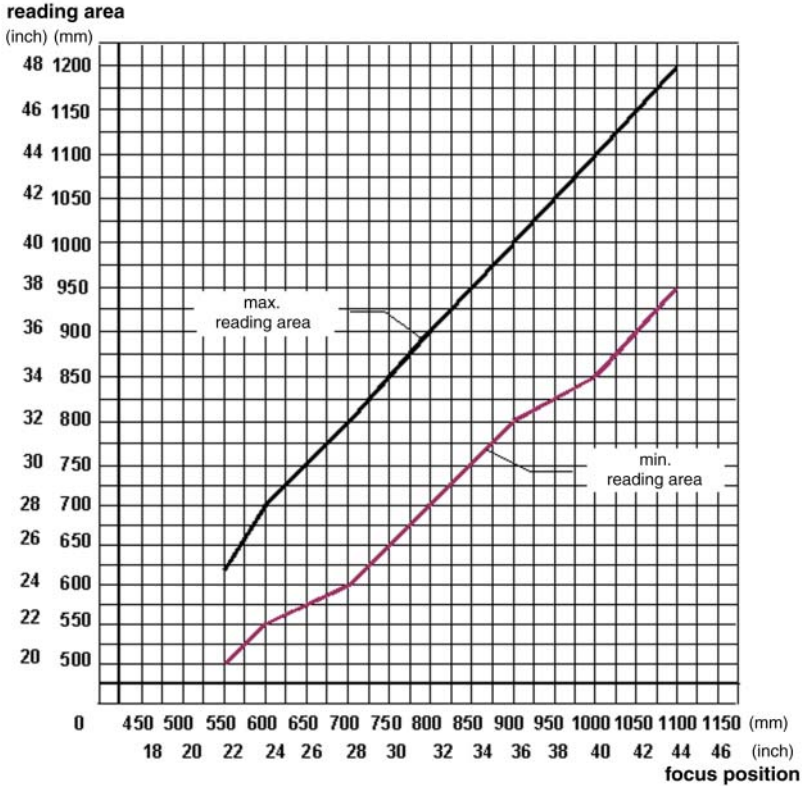

Figure 8.14 Radial distances for standard model with 0,25 mm/10 mils

Date of issue 06/13/2005

VB34-2500 (standard), resolution: 0,30 mm (12 mils)

The diagram shows a global reading zone, which is practically the sum of all the possible focus positions, and the reading zone, which results for the VB34 from a focus position of 1100 mm and a barcode density of 0,30 mm (12 mils).

The values for the maximum and the minimum distances are found in the radial distance curves in Figure 8.16.

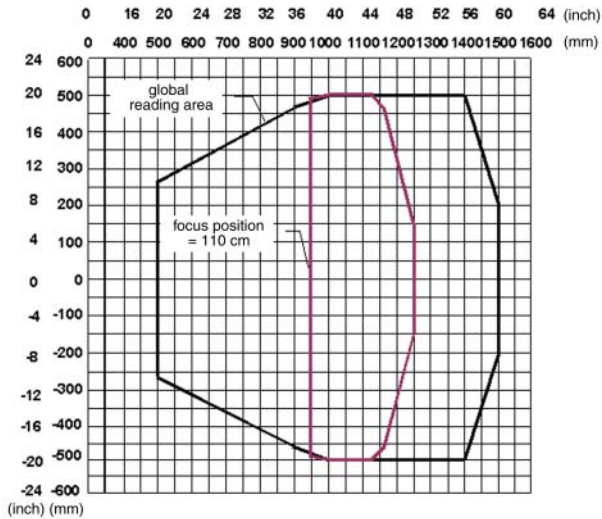

Figure 8.15 Read diagram of the standard model with 0,30 mm/12 mils

Remark: (0,0) is the central position of the laser release window.

Barcode reader VB34

Optical properties

Conditions

- Code = interleaved 2 from 5 or code 39
- PC = 0,90
- Tilt angle = 0°
- Angle of rotation = 10° - 20°
- Tilt = 0°

The curves show the minimum and maximum radial distances.

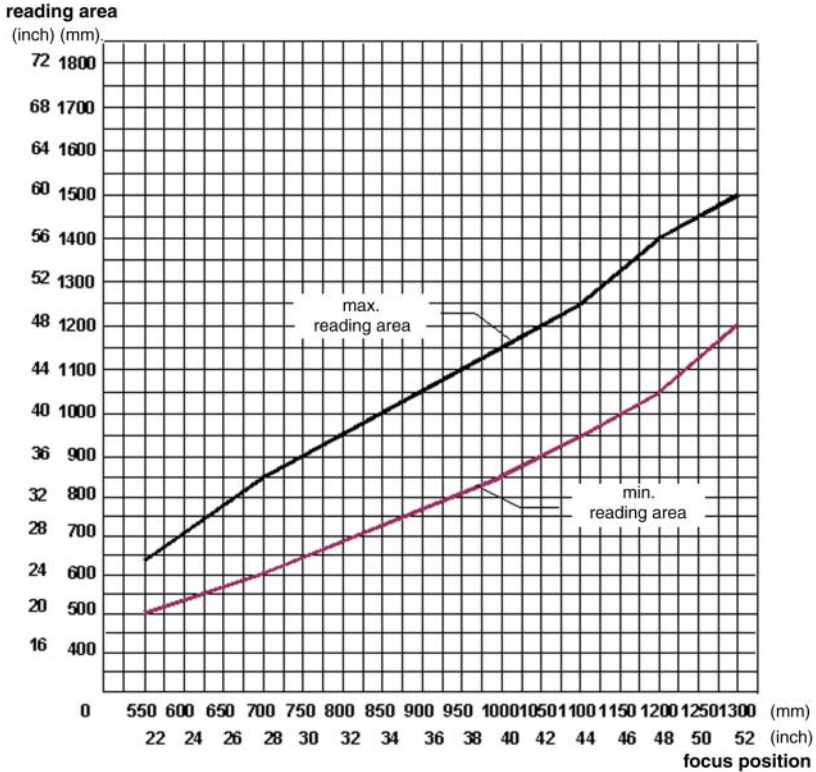

Figure 8.16 Radial distances for standard model with 0,30 mm/12 mils

Date of issue 06/13/2005

VB34-2500 (standard), resolution: 0,375 mm (15 mils)

The diagram shows a global reading zone, which is practically the sum of all the possible focus positions, and the reading zone, which results for the VB34 from a focus position of 1400 mm and a barcode density of 0,375 mm (15 mils).

The values for the maximum and the minimum distances are found in the radial distance curves in Figure 8.18.

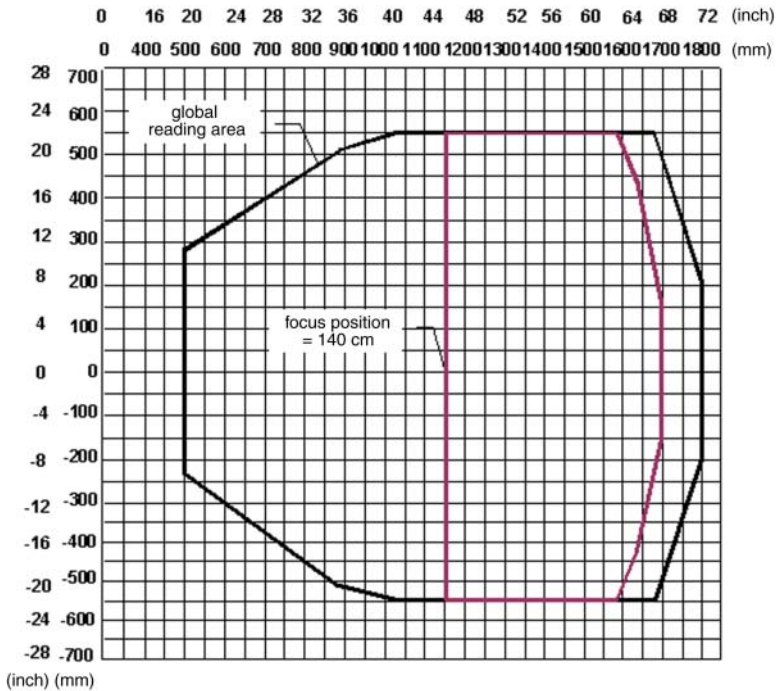

Figure 8.17 Read diagram of the standard model with 0,375 mm/15 mils

Remark: (0,0) is the central position of the laser release window.

Barcode reader VB34

Optical properties

Conditions

- Code = interleaved 2 from 5 or code 39
- PC = 0,90
- Tilt angle = 0°
- Angle of rotation = 10° - 20°
- Tilt = 0°

The curves show the minimum and maximum radial distances.

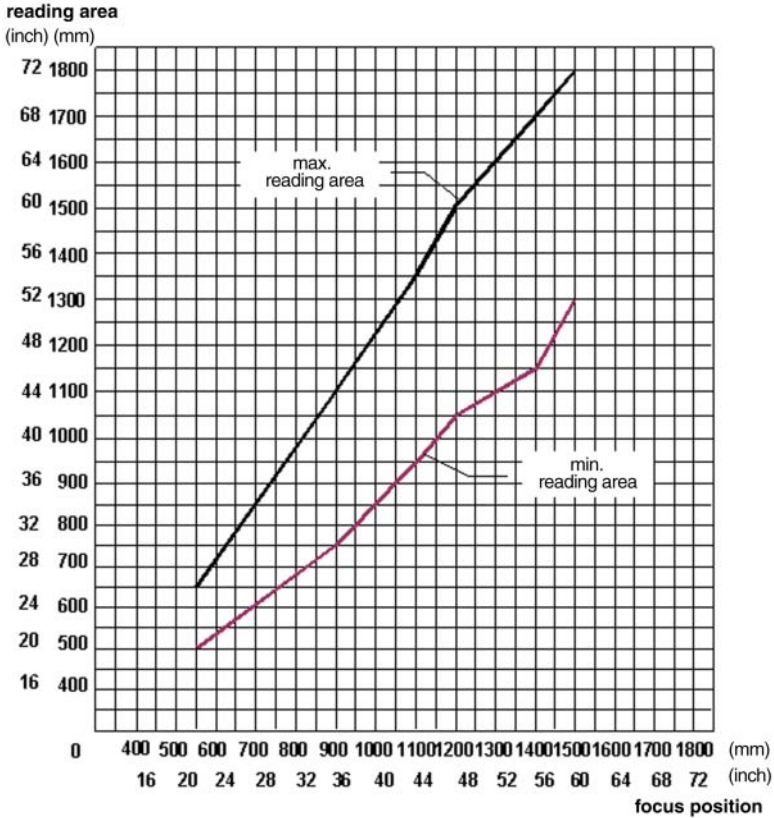

Figure 8.18 Radial distances for standard model with 0,375 mm/15 mils

Date of issue 06/13/2005

VB34-2500 (standard), resolution: 0,5 mm (20 mils)

The diagram shows a global reading zone, which is practically the sum of all the possible focus positions, and the reading zone, which results for the VB34 from a focus position of 1200 mm and a barcode density of 0,5 mm (20 mils).

The values for the maximum and the minimum distances are found in the radial distance curves in Figure 8.20.

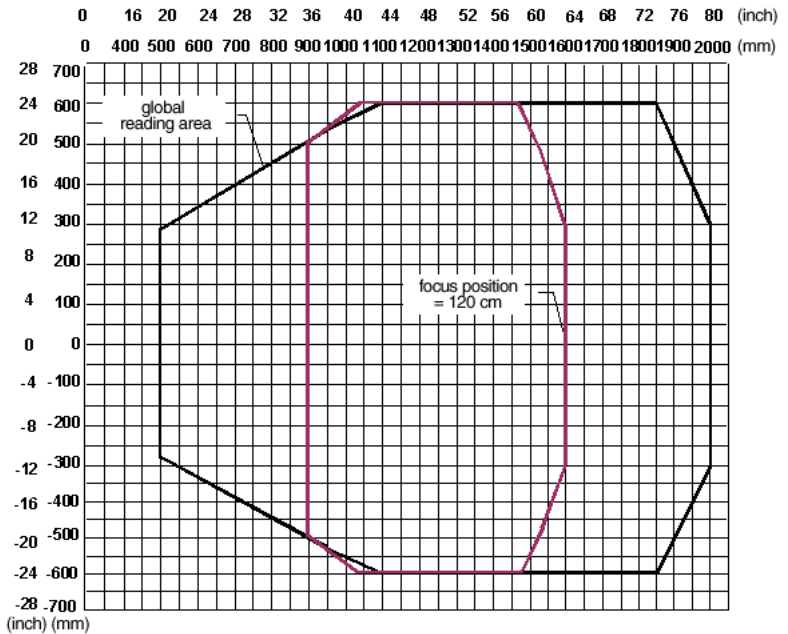

Figure 8.19 Read diagram of the standard model with 0,50 mm/20 mils

Remark: (0,0) is the central position of the laser release window.

Barcode reader VB34

Optical properties

Conditions

- Code = interleaved 2 from 5 or code 39
- PC = 0,90
- Tilt angle = 0°
- Angle of rotation = 10° - 20°
- Tilt = 0°

The curves show the minimum and maximum radial distances.

reading area
(inch) (mm)

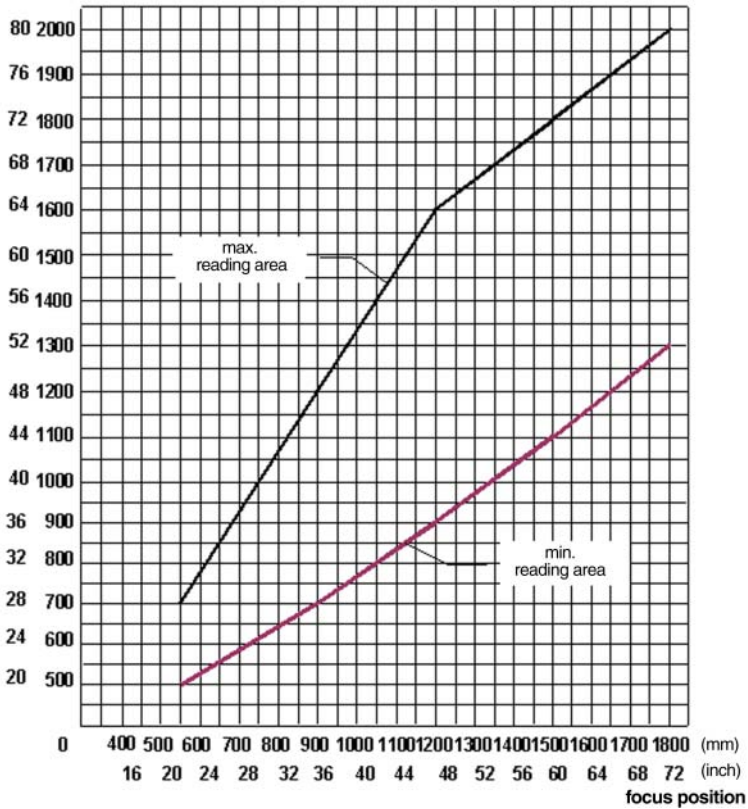

Figure 8.20 Radial distances for standard model with 0,50 mm/20 mils

Date of issue 06/13/2005

8.3.2 VB34 model with reflex mirror

VB34-2500-OM, resolution: 0,20 mm (8 mils)

The diagram shows a global reading zone, which is practically the sum of all the possible focus positions, and the reading zone, which results for the VB34-2500-OM from a focus position of 600 mm and a barcode density of 0,20 mm (8 mils).

The values for the maximum and the minimum distances are found in the radial distance curves in Figure 8.22.

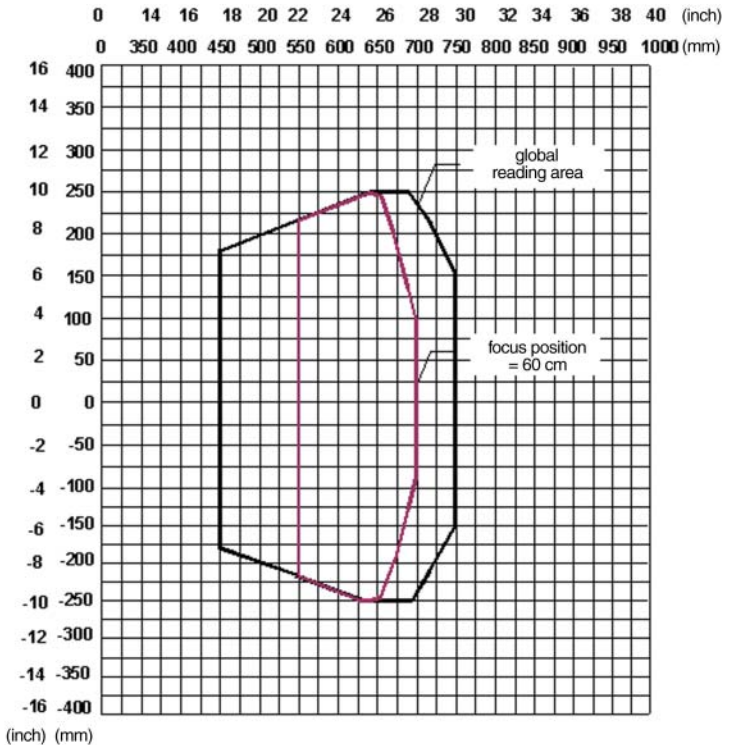

Figure 8.21 Read diagram of the oscillating mirror model with 0,20 mm/8 mils

Remark: (0,0) is the central position of the laser release window.

Barcode reader VB34

Optical properties

Conditions

- Code = interleaved 2 from 5 or code 39
- PC = 0,90
- Tilt angle = 0°
- Angle of rotation = 10° - 20°
- Tilt = 0°

The curves show the minimum and maximum radial distances.

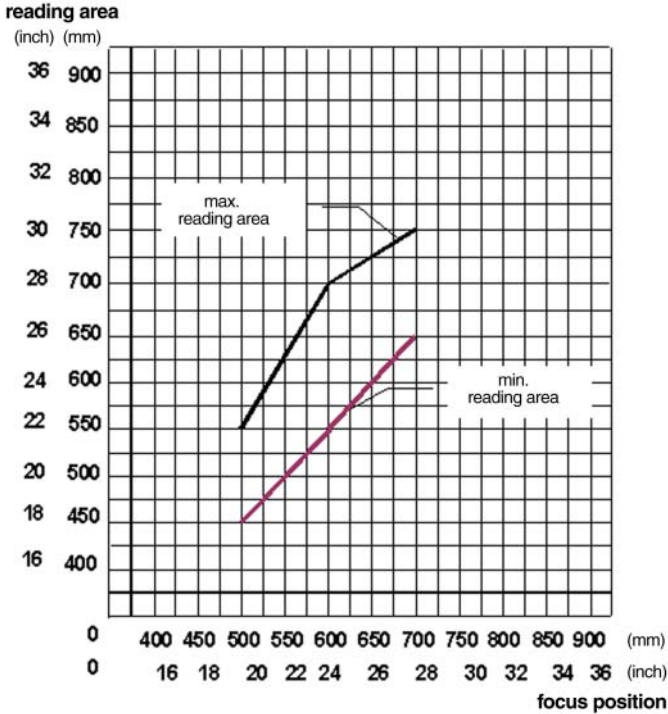

Figure 8.22 Radial distances for oscillating mirror model with 0,20 mm/8 mils

Date of issue 06/13/2005

VB34-2500-OM, resolution: 0,25 mm/10 mils

The diagram shows a global reading zone, which is practically the sum of all the possible focus positions, and the reading zone, which results for the VB34-2500-OM from a focus position of 950 mm and a barcode density of 0,25 mm (10 mils).

The values for the maximum and the minimum distances are found in the radial distance curves in Figure 8.24.

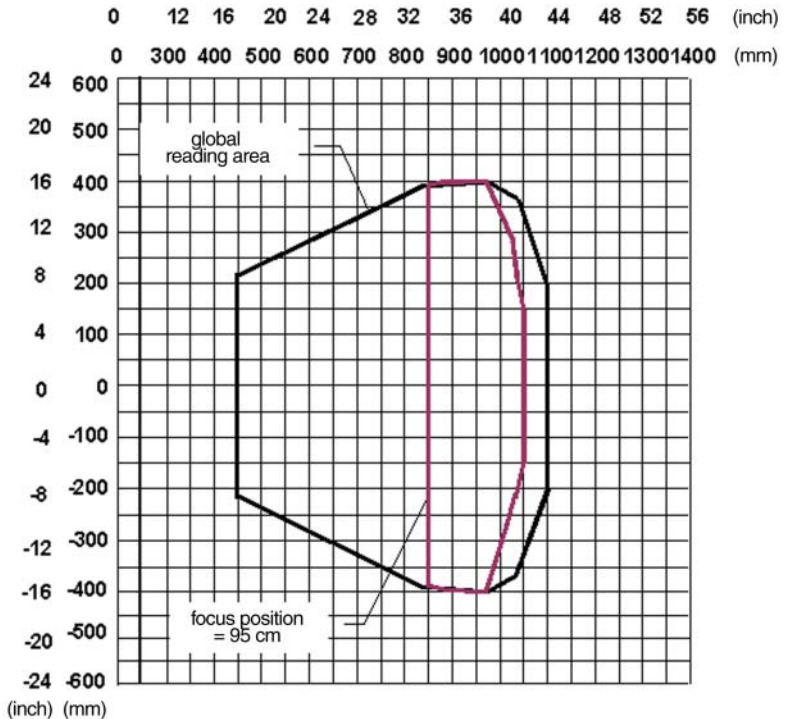

Figure 8.23 Read diagram of the oscillating mirror model with 0,25 mm/10 mils

Remark: (0,0) is the central position of the laser release window.

Barcode reader VB34

Optical properties

Conditions

- Code = interleaved 2 from 5 or code 39
- PC = 0,90
- Tilt angle = 0°
- Angle of rotation = 10° - 20°
- Tilt = 0°

The curves show the minimum and maximum radial distances.

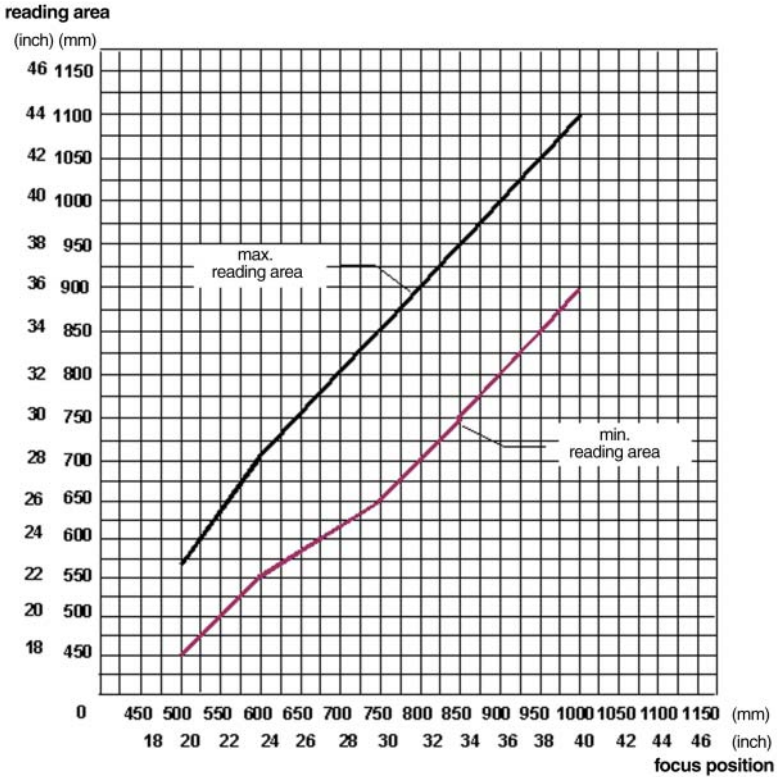

Figure 8.24 Radial distances for oscillating mirror model with 0,25 mm/10 mils

VB34-2500-OM, resolution: 0,30 mm/12 mils

The diagram shows a global reading zone, which is practically the sum of all the possible focus positions, and the reading zone, which results for the VB34-2500-OM from a focus position of 1100 mm and a barcode density of 0,30 mm (12 mils).

The values for the maximum and the minimum distances are found in the radial distance curves in Figure 8.26.

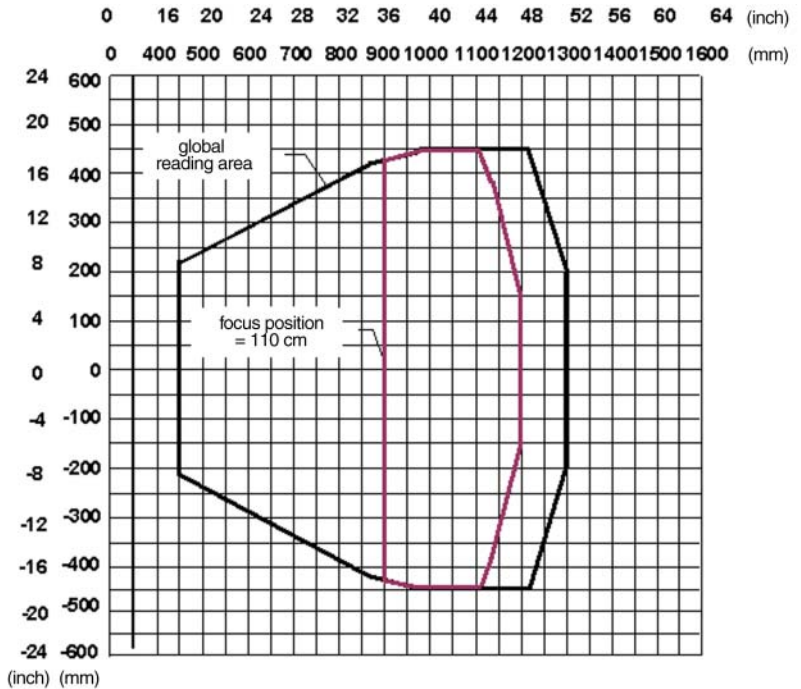

Figure 8.25 Read diagram of the oscillating mirror model with 0,30 mm/12 mils

Remark: (0,0) is the central position of the laser release window.

Barcode reader VB34

Optical properties

Conditions

- Code = interleaved 2 from 5 or code 39
- PC = 0,90
- Tilt angle = 0°
- Angle of rotation = 10° - 20°
- Tilt = 0°

The curves show the minimum and maximum radial distances.

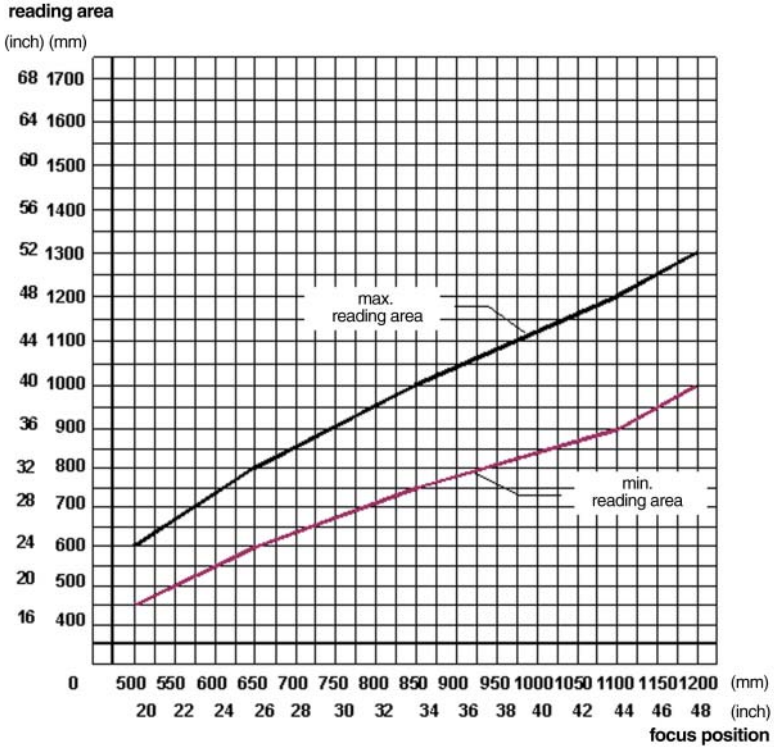

Figure 8.26 Radial distances for oscillating mirror model with 0,30 mm/12 mils

Date of issue 06/13/2005

VB34-2500-OM, resolution: 0,375 mm/15 mils

The diagram shows a global reading zone, which is practically the sum of all the possible focus positions, and the reading zone, which results for the VB34-2500-OM from a focus position of 1150 mm and a barcode density of 0,375 mm (15 mils).

The values for the maximum and the minimum distances are found in the radial distance curves in Figure 8.28.

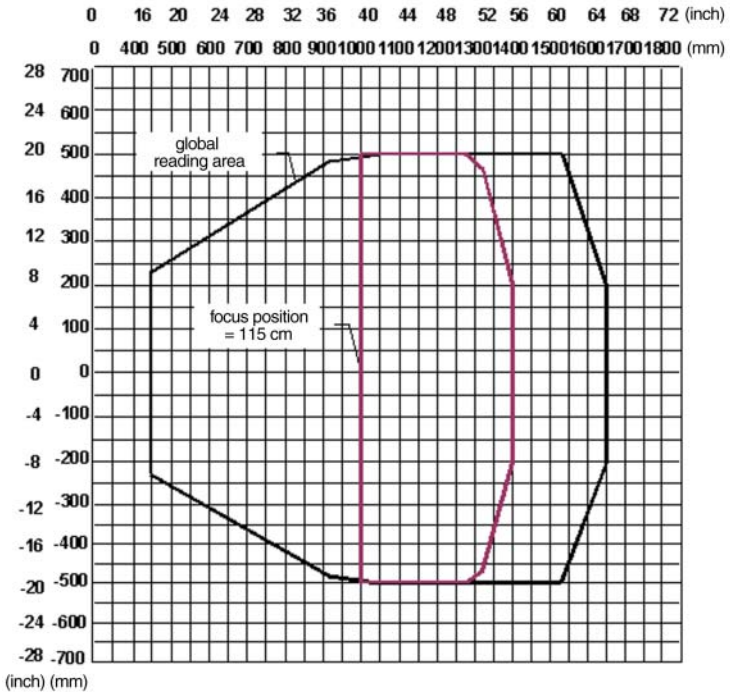

Figure 8.27 Read diagram of the oscillating mirror model with 0,375 mm/15 mils

Remark: (0,0) is the central position of the laser release window.

Barcode reader VB34

Optical properties

Conditions

- Code = interleaved 2 from 5 or code 39
- PC = 0,90
- Tilt angle = 0°
- Angle of rotation = 10° - 20°
- Tilt = 0°

The curves show the minimum and maximum radial distances.

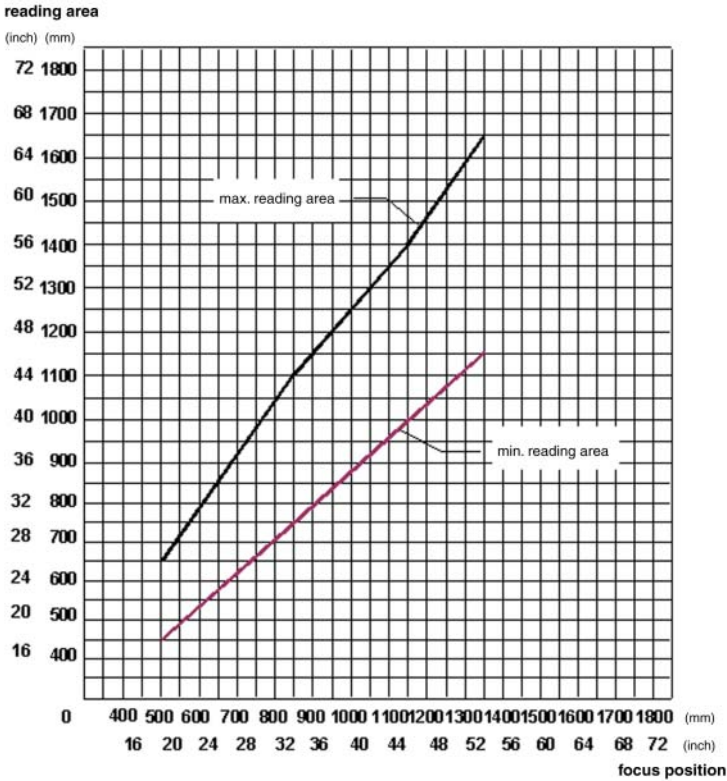

Figure 8.28 Radial distances for oscillating mirror model with 0,375 mm/15 mils

Date of issue 06/13/2005

VB34-2500-OM - resolution: 0,50 mm/20 mils

The diagram shows a global reading zone, which is practically the sum of all the possible focus positions, and the reading zone, which results for the VB34-2500-OM from a focus position of 1150 mm and a barcode density of 0,50 mm (20 mils).

The values for the maximum and the minimum distances are found in the radial distance curves in Figure 8.30.

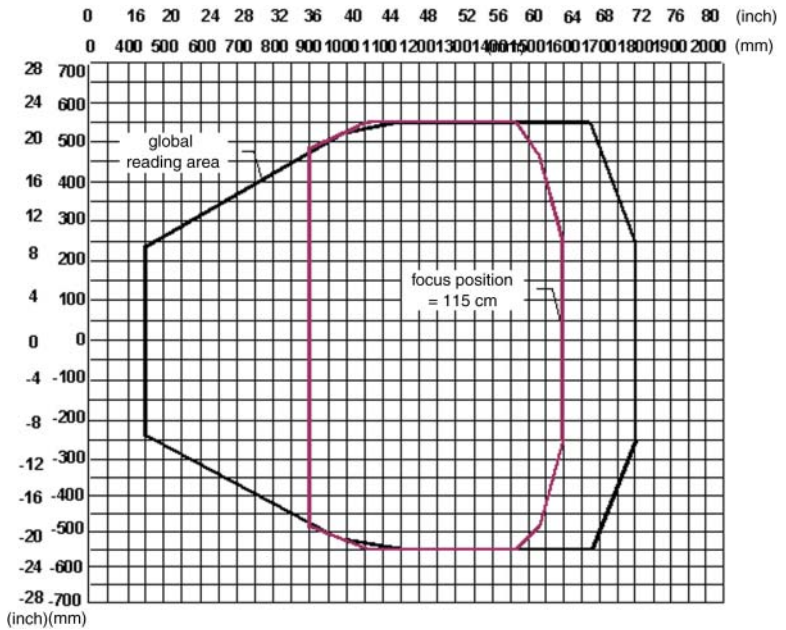

Figure 8.29 Read diagram of the oscillating mirror model with 0,50 mm/20 mils

Remark: (0,0) is the central position of the laser release window.

Barcode reader VB34

Optical properties

Conditions

- Code = interleaved 2 from 5 or code 39
- PC = 0,90
- Tilt angle = 0°
- Angle of rotation = 10° - 20°
- Tilt = 0°

The curves show the minimum and maximum radial distances.

reading area (inch) mm

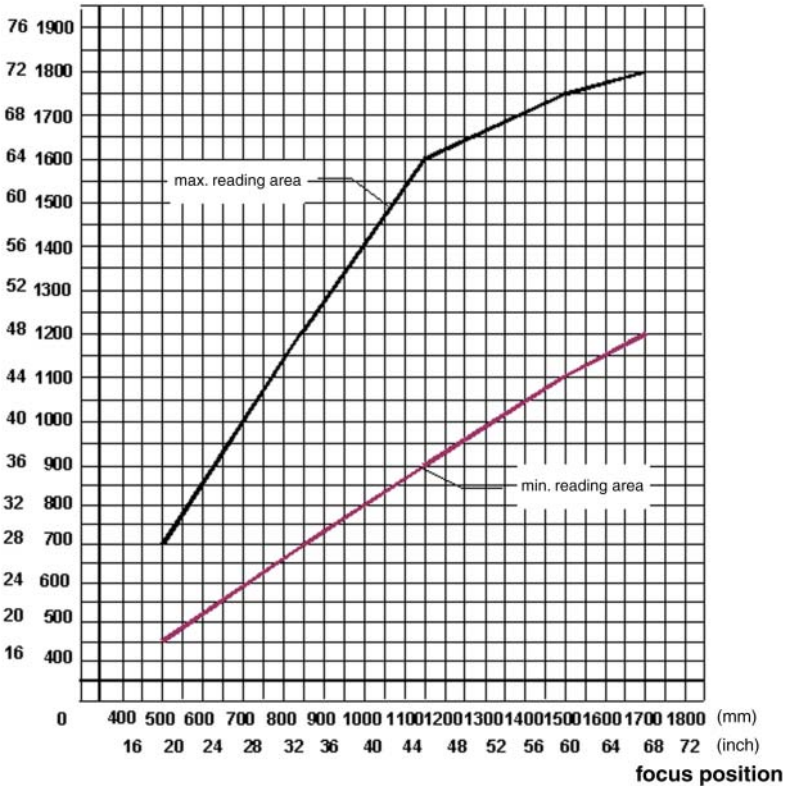

Figure 8.30 Radial distances for oscillating mirror model with 0,50 mm/20 mils

Date of issue 06/13/2005

9 Maintenance

9.1 Cleaning

Clean the laser exit window (Figure 3.1/Figure 3.2) regularly to ensure the reader operates fault free.

Dust, impurities etc. on the window can have a negative affect on the reading performance.

Carry out cleaning in very dirty surroundings more frequently as required.

Clean the window using a soft cloth moistened with alcohol. Do not use any abrasive cleaning agents.



Warning

Clean the window of the VB34 when the reader is switched off or, at least, when the laser beam is not active.

10 Troubleshooting



Note

*Before you contact your local Pepperl+Fuchs distributors, save the device configuration using the configuration program in a *.ddc file and make a note of the exact model and serial number of the device.*

Guide on troubleshooting

Description of error	Diagnostics/remedy
<p>Switch on</p> <p>The LED "voltage supply" does not light.</p>	<ul style="list-style-type: none"> • Is the voltage connected correctly? • If using a power pack, is this plugged in? • If using a supply connector, is this live? • If using a C-BOX 100, is the supply voltage connected (check selector switch and LED)? Check whether you are working on a 25/26-pin connector or the spring-loaded terminals of a C-BOX 100. • Measure the voltage on pin 13 and pin 25 (for 25-/26-pin connectors) or on the contacts 1 and 2 (spring-loaded terminals C-BOX 100).

Barcode reader VB34

Troubleshooting

Description of error	Diagnostics/remedy
<p>Online operating mode:</p> <p>The LED "Phase On" of the master does not light (when the external trigger is activated).</p>	<ul style="list-style-type: none"> • Check whether you are working on a 25/26-pin connector or the spring-loaded terminals of a C-BOX 100. • Is the sensor connected to the external trigger input EXT TRIG? • Is the light barrier supplied with electrical power? • Is one of the two EXT TRIG terminals (NPN output) supplied? • Is one of the two EXT TRIG terminals connected to ground (PNP output)? • Do the LEDs (if available) of the light barriers work trouble-free? • Is the sensor/reflector system (if available) aligned correctly?
<p>Online operating mode:</p> <p>The LED "Phase On" of the master follows the trigger, but the read system remains functionless (no read process).</p>	<ul style="list-style-type: none"> • Does the software configuration match the application conditions (operating mode, etc.)? <p>Check the corresponding parameters in the operating modes folder of the configuration software.</p>
<p>Serial online operating mode:</p> <p>The reader is not triggered (no read process).</p>	<ul style="list-style-type: none"> • Check whether "serial online" is activated as the "online options" in the operating modes folder of the configuration software. • Are the start and stop strings assigned correctly? • Is the serial trigger source connected correctly?
<p>Online operating mode and serial online operating mode:</p> <p>The reader does not respond correctly to the signal end.</p>	<ul style="list-style-type: none"> • Check the setting of parameter "Timeout for read cycle" in the operating modes folder of the configuration software.

Date of issue 06/13/2005

Description of error	Diagnostics/remedy
<p>Reading:</p> <p>Target code cannot be read (no result is ever output)</p>	<ul style="list-style-type: none"> • Check the synchronization between the read impulse and the object to be read. • Is the scan line aligned correctly? Place a barcode in the center of the scan line and start the test mode (can be selected as the operating mode in Genius™). If the problem persists: <ul style="list-style-type: none"> • Does the reading distance lie in the permissible limits (see reading fields)? • Is the tilt angle too large? • Is the angle of rotation under 10° (direct reflection)? • Select the CODE properties tab and activate various code types (except for pharmacode). Length = variable. • Is the code quality sufficient? • If the problem persists, carry out a test with the test sheet from Datalogic, enclosed with the product.
<p>Communication:</p> <p>The device does not transmit any data to the host.</p>	<ul style="list-style-type: none"> • Is the cable for the serial interface connected? • Is the wiring correct? • If using the primary RS232 or RS485 interface, is the earth reference connected with the correct signal ground SGND (also referred to as GND_ISO)? Bear in mind that this ground does not have any connection to the ground of the supply (GND). • If using a C-BOX 100, make sure that the RS485 termination switch is set to OFF. • Are the serial communication parameters set in the same way for the host and the device?
<p>Communication:</p> <p>No data appears on the terminal.</p>	<ul style="list-style-type: none"> • In the configuration software, activate parameter "Transmitted data" in the data communication settings for the primary/secondary interface.

Barcode reader VB34

Troubleshooting

Description of error	Diagnostics/remedy
<p>Communication:</p> <p>The data transmitted to the host is faulty, incorrect or incomplete.</p>	<ul style="list-style-type: none"> • In the configuration program, select the folder DATA COMMUNICATION SETTINGS/DATA FORMAT and check the entries for HEADER, TERMINATOR, SEPARATOR and FILL CHAR. • Also check the field CODE FIELD LENGTH for the code length. • Are the interface parameters set correctly?
<p>How do I find out the serial number of my device?</p>	<ul style="list-style-type: none"> • The serial number is located on a label above the connector of the reader. • The serial number can also be called via the configuration software. • The serial number is made up of 9 characters: 1 letter, 2 numbers, another letter and finally 5 numbers.

Date of issue 06/13/2005

11 Technical data

Electrical features (see remark 1)		
Operating voltage	15 to 30 V DC	
Power consumption	15 W typically 20 W max. (including starting current)	
Communication interfaces	Primary (galv. separate)	Baud rate
	RS232	1200 to 115200
	RS485 full-duplex	1200 to 115200
	RS485 half duplex	1200 to 115200
	20 mA current loop (with INT-60 accessories)	19200
	Secondary	
	RS232	1200 to 115200
	Miscellaneous	
	Lonworks	1,25 Mb/s
	Ethernet	10 or 100 Mb/s
	DeviceNet	125 or 250 Kb/s
	Profibus	12 Mb/s
Inputs (NPN or PNP, with optocouplers)	External trigger 1 3 additional digital inputs	
Outputs (with optocouplers)	3 digit outputs programmable by software	
Figure system (see remark 1)		
Light receiver	APD (avalanche photodiode)	
Wave length	630 to 680 nm	
Safety class	Class 2 - EN60825-1; Class II - CDRH	
Laser control	Safety system switches off laser when motor becomes slower	
Optical properties:		
Scan rate	600-1200 read processes/sec	
Maximum resolution	(see reading fields)	
Max. reading distance	(see reading fields)	
Max. reading width	(see reading fields)	
Max. depth of the field	(see reading fields)	
Deflection angle	(see reading fields)	
Operator interface		
LCD display	2 lines each with 16 characters	
Key field	3 keys	
Status LEDs	Power ON (red) Phase ON (yellow) TX Data (green)	

Remark 1: If not otherwise indicated, all specifications refer to an ambient temperature of 25 °C.

Date of issue 06/13/2005

Barcode reader VB34

Technical data

Software features		
Readable code families		
<ul style="list-style-type: none"> • Interleaved 2/5 • Code 39 standard • Codabar • EAN/UPC • Code 128 • EAN128 • Code 93 (standard and full ASCII set) 		
Code selection	Up to 10 codes in a read cycle	
Section and termination	The transmitted messages can be adjusted via a section and a termination each with a length of 128 bytes.	
Operating modes	Online Automatic Test	
Configuration types	Software	
Parameter memory	Non volatile internal Flash memory	
Ambient conditions		
Operating temperature	0° to +40 °C (+32° to +104 °F)	
Storage temperature	-20° to +70 °C (-4° to +158 °F)	
Humidity	90%, non-condensing	
Vibration exposure	IEC 68-2-6 test FC 1,5 mm; 10 to 55 Hz; 2 hrs in each axis	
Shock exposure	IEC 68-2-27 test EA 30 G; 11 ms; 3 shocks in each axis	
Protection class	IP64*	
Mechanical features	Standard models	Oscillating mirror models
Dimensions in mm (inches)	110 x 113 x 99 (4.33 x 4.45 x 3.9)	113 x 180 x 104,5 (4.45 x 7.08 x 4.11)
Mass	1,5 kg (3,3 lb)	2,0 kg (4,4 lb)

* Protection class IP50 for Ethernet conventional versions

Date of issue 06/13/2005

12 Glossary

ACR™ 3

All the versions of the base assembly are equipped with the high-capacity ACR technology for the reconstruction of codes (ACR™ 3). The new, third generation of ACR™ improves the read and reconstruction capability in the case of damaged or heavily slanted barcodes significantly.

Resolution

The smallest sub-division of an element, which can be distinguished by a given reader or represented by an output device.

Deflection

The angular range across which the mirror can be adjusted in order to scan a surface to be read.

Barcode

A series of lines of varying width, which are separated by empty spaces and represent numeric or alphanumeric data in a machine readable form. Basically, a barcode symbol consists of a quiet area zone at the start, a start character, data or contents characters, check digit (if used), stop character and a subsequent quiet area zone. Within this basic structure, all the readable symbologies use their own format.

Barcode label

A label containing a barcode which can be attached to an article.

Baud rate

A unit for measuring the data transmission rate or the speed during the data exchange.

CDRH (Center for Devices and Radiological Health)

The Center for Devices and Radiological Health (an agency belonging to the American health authority FDA) is responsible for safety guidelines and radiation limit values of laser devices. VISOLUX devices meet the requirements stipulated by CDRH.

CD SQUARE™

CD SQUARE™ provides useful information pertaining to the label position and the form of the object, which were determined in the read phase of the barcode. This innovative technology indicates the area which contains the code and measures the distance of the code to the reader.

Code alignment

Different spacial arrangements of the code, which have an effect on the ability of the reader to read the code. The terms tilt angle, angle of rotation and tilt describe the angle variations of the code alignment in the X, Y and Z axes (Chapter 6.5). Changes to the code alignment have an effect on the impulse width and thus on the decoding of the code. The impulse width is defined as the change of the leading edge of a bar or spacing to the falling edge of a bar or spacing over time. The impulse width is also referred to as the transition. The rotation, tilt and visual angle have an effect on the impulse width of the code.

Angle of rotation

A rotation around the Y axis. This deviation from the horizontal and vertical can refer to individual characters, lines or whole coded objects (Chapter 6.5).

EEPROM

This is short for Electrically Erasable Programmable Read-Only Memory. A non volatile memory.

Flash™

Flash™ is the new, dynamic focussing system, which is implemented in VB34. Flash™ is able to assume any reading position from the minimum position to the maximum position in less than 10 milliseconds. In typical applications with a reading distance of less than 1 meter, the reading position is reached in 4 milliseconds. The Flash™ technology makes it possible for the VB34 to cover a reading zone of more than 2 meters.

Half duplex

Transmission of data in only one transmission direction at a given point in time.

Host

A computer, which operates terminals in a network and provides services such as network management, database access, special programs, control programs and programming languages.

Tilt angle

A rotation around the Z axis. Serves to describe the position of a barcode in relation to the laser scanning line (Chapter 6.5).

Laser diode with visible wave length

A light source used in readers to illuminate the barcode symbol. It produces a red light in an area visible to the human eye between 630 and 680 nm.

LED (light emitting diode, also referred to as luminescence diode)

A semiconductor-based light source with a low energy requirement, which emits light in the visible or in the infrared area continuously or in impulse form to show whether voltage exists. It is frequently used for display purposes. Its power consumption is less than that of an electric light bulb, but above that of liquid crystal displays (LCD). If the service conditions are adhered to, the LEDs have an extremely long life.

Reader

A device which reads printed patterns (barcodes) and which either transmits the data in an unevaluated state to a decoder or decodes the data and transmits this data to a host system.

Multidrop lead

A communication path to which several partners can be connected. Also refer to **RS485**.

Tilt angle

The rotation of the code in the X axis. S. Section (Chapter 6.5).

PackTrack™

PackTrack™ is a patented packet tracking system, which improves the read functionality in omnidirectional stations. PackTrack™ manages 6-page read systems, where it is not possible to recognize the actual position of the code on the packet. External accessories which are indispensable in traditional tracking systems are thus unnecessary.

Parameters

A value for specific attributes, which you specify in a program. Generally, parameters are set in order to configure the device to a certain operating behavior.

Position

The position of the reader or the light source relative to the target of a receiver element.

Protocol

A collection of formal conventions pertaining to the formatting and time-specific course of messages and their exchange between two communication partners.

RS232

An interface standard for the serial, binary data exchange between a DTE (data terminal equipment) and a DCE (data communications equipment), that is, between two partners.

RS485

An interface standard for the serial data exchange between several transmitters and receivers via a symmetrical transmission system with several partners, such as via a Multidrop lead.

Interface

A device connection that can be used externally with standardized electrical characteristic values, signal characteristics and meanings of the exchanged signals.

Serial interface

An I/O interface for connecting the reader to a computer, often can be recognized by a 9 or 25-pin connector.

Signal

An impulse or a variable electrical size (e.g. a voltage or a current), whose changes express a piece of information.

Step-a-Head™

Step-a-Head™ makes it possible to turn the head of the reader and decoder base assembly independently from one another. A result of the Step-a-Head™ technology is that the VB34 can always be installed in the ideal position. In this instance, it is possible to change the alignment of the connector plugs, while the laser window retains its original position.

Symbol

A combination of characters including start and stop as well as check sum digits according to requirement, which together form a machine readable barcode.

Trigger signal

A signal, which generally comes from a light barrier or a proximity switch, informing the reader that there is an object in its reading field.

UPC

An abbreviation for Universal Product Code, the standard barcode type for retail packaging in the USA.

Full-duplex

Simultaneous and independent exchange of data in both transmission directions.

Notes

Barcode reader VB34

Notes

Date of issue 06/13/2005

With regard to the supply of products, the current issue of the following document is applicable: The General Terms of Delivery for Products and Services of the Electrical Industry, published by the Central Association of the Electrical Industry (Zentralverband Elektrotechnik und Elektroindustrie (ZVEI) e.V.) in its most recent version as well as the supplementary clause: "Expanded reservation of proprietorship"

We at Pepperl+Fuchs/VISOLUX recognize a duty to make a contribution to the future.
For this reason, this printed matter is produced on paper bleached without the use of chlorine.

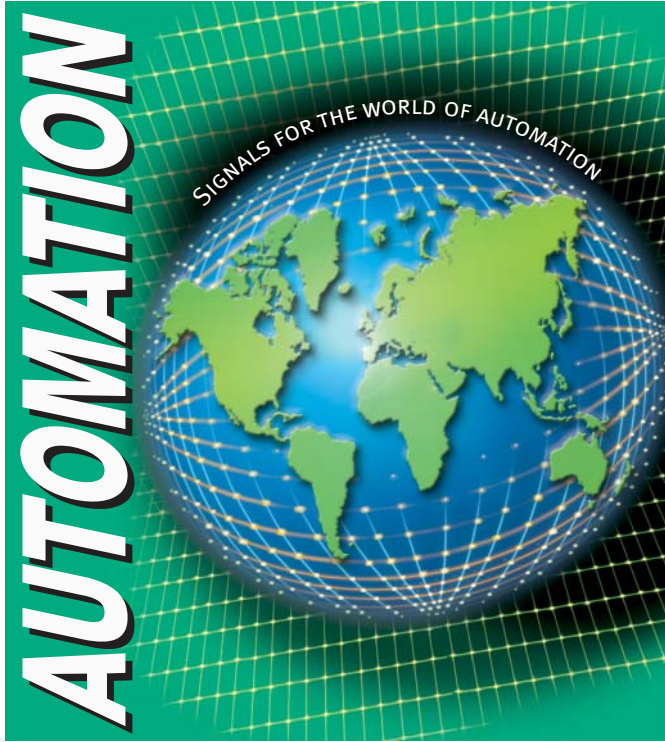

www.pepperl-fuchs.com

Worldwide Headquarters

Pepperl+Fuchs GmbH · Königsberger Allee 87
68307 Mannheim · Germany
Tel. +49 621 776-0 · Fax +49 621 776-1000
e-mail: info@de.pepperl-fuchs.com

USA Headquarters

Pepperl+Fuchs Inc. · 1600 Enterprise Parkway
Twinsburg, Ohio 44087 · Cleveland-USA
Tel. +1 330 4253555 · Fax +1 330 4 25 93 85
e-mail: sales@us.pepperl-fuchs.com

Asia Pacific Headquarters

Pepperl+Fuchs Pte Ltd. · P+F Building
18 Ayer Rajah Crescent · Singapore 139942
Tel. +65 67799091 · Fax +65 68731637
e-mail: sales@sg.pepperl-fuchs.com

 **PEPPERL+FUCHS**
SIGNALS FOR THE WORLD OF AUTOMATION