

Advanced Diagnostics

HD2-DM-A

KT-MB-DMA

KT-MB-GT2AD.FF

KT-MB-GT2AD.FF.IO

Manual

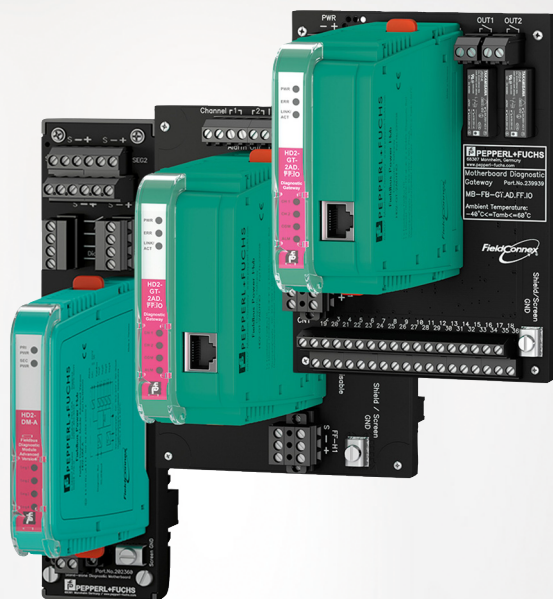

Your automation, our passion.

 **PEPPERL+FUCHS**

With regard to the supply of products, the current issue of the following document is applicable: The General Terms of Delivery for Products and Services of the Electrical Industry, published by the Central Association of the Electrical Industry (Zentralverband Elektrotechnik und Elektroindustrie (ZVEI) e.V.) in its most recent version as well as the supplementary clause: "Expanded reservation of proprietorship"

Worldwide

Pepperl+Fuchs Group
Lilienthalstr. 200
68307 Mannheim
Germany
Phone: +49 621 776 - 0
E-mail: info@de.pepperl-fuchs.com

North American Headquarters

Pepperl+Fuchs Inc.
1600 Enterprise Parkway
Twinsburg, Ohio 44087
USA
Phone: +1 330 425-3555
E-mail: sales@us.pepperl-fuchs.com

Asia Headquarters

Pepperl+Fuchs Pte. Ltd.
P+F Building
18 Ayer Rajah Crescent
Singapore 139942
Phone: +65 6779-9091
E-mail: sales@sg.pepperl-fuchs.com
<https://www.pepperl-fuchs.com>

1	Safety	9
1.1	Validity	9
1.2	Symbols Used	9
1.3	Target Group, Personnel	9
1.4	Reference to Further Documentation	10
1.5	Delivery, Transport, and Storage	10
1.6	Marking	10
1.7	Intended Use	10
1.8	Mounting/Installation	11
1.9	Operation, Maintenance, Repair	11
1.10	Disposal	11
2	General Description	12
2.1	General System Layout and PCS Integration	13
2.2	General Terms and Functions for Advanced Diagnostics	14
2.2.1	Expert System	15
2.2.2	Commissioning Wizard	15
2.2.3	Diagnostic Gateway Mode (DGW Mode)	15
2.2.4	Field Device Handling	16
3	Product Description	17
3.1	HD2-DM-A - Advanced Diagnostic Module.....	17
3.1.1	Assembly	17
3.1.2	Technical Data	17
3.1.3	LED Indication	19
3.1.4	Mounting the Diagnostic Module	20
3.2	KT-MB-DMA - Advanced Diagnostic Module, Kit for Stand-Alone Operation.....	21
3.2.1	Assembly	22
3.2.2	Technical Data	22
3.2.3	Mounting the Stand-Alone Kit and the Advanced Diagnostic Module	23
3.3	KT-MB-GT2AD.FF - Diagnostic Gateway, Kit with Motherboard	25
3.3.1	Assembly	26
3.3.2	Technical Data	27
3.3.3	LED Indication	30

3.4	KT-MB-GT2AD.FF.IO - Diagnostic Gateway, Kit with I/O Motherboard	31
3.4.1	Assembly	32
3.4.2	Technical Data.....	34
4	Hardware Installation	39
4.1	Power Hub and Advanced Diagnostic Module.....	39
4.1.1	Installing the Diagnostic Bus	40
4.1.2	Device Address Assignment	41
4.1.3	Connecting the PCS Connection.....	41
4.2	Kit for Stand-Alone Operation and Advanced Diagnostic Module.....	42
4.2.1	Installing the Diagnostic Bus	43
4.2.2	Connecting Stand-Alone Kits to Segments	44
4.2.3	Device Address Assignment	41
4.2.4	Connecting the PCS Connection.....	41
4.3	Shielding and Grounding	45
4.4	Volt-Free Contact Installation	47
4.4.1	KT-MB-GT2AD.FF	48
4.4.2	KT-MB-GT2AD.FF.IO	48
5	FDS/OPC Integration	49
5.1	Installation of Diagnostic Manager with PACTware™.....	50
5.2	Licensing	51
5.3	FDS Control Center.....	52
5.3.1	FDS Configuration.....	52
5.3.2	FDS Configuration Options	53
5.4	Project Setup.....	55
5.4.1	Tags Used in ADM Projects.....	55
5.4.2	Communication with the Diagnostic Gateway	55
5.4.3	Manual Setup of a Diagnostic Project with PACTware™	55
5.4.4	Assign Diagnostic Gateway Addresses.....	58
5.4.5	Assign HD2-DM-A Addresses.....	60
5.4.6	Scanning of a Diagnostic Installation for Project Setup	61
5.4.7	Import of Diagnostic Project from File.....	62
5.4.8	Import of Diagnostic Project from FDS	63
5.4.9	Set Snapshot Archive Location	64
5.5	Operation with Device Type Managers (DTM)	65

5.6	Online Parameterization	66
5.6.1	Overview.....	66
5.6.2	Settings.....	67
5.6.3	Commissioning Wizard	68
5.6.4	System Commissioning	68
5.6.5	Segment Commissioning.....	69
5.6.6	Generate Report for HD2-DM-A.RO DIP Switch Settings	70
5.7	Diagnostics	71
5.7.1	Expert Diagnostics.....	71
5.7.2	Current Alarms Diagnostics Tab.....	72
5.7.3	Alarm History Diagnostics Tab	72
5.8	Measured Value	75
5.8.1	System & Segment Measurement	75
5.8.2	Field Device Signal Level	76
5.8.3	Field Device Measurement	77
5.8.4	Fieldbus Statistics.....	77
5.8.5	Snapshot Creation	77
5.9	Snapshot Explorer	78
5.9.1	Snapshot Toolbar	79
5.10	Advanced Parameterization and Parameterization	80
5.10.1	Field Device Handling	83
5.11	History Export	85
5.11.1	Long-Term History.....	85
5.11.2	Export History	85
5.11.3	Excel Export Feature.....	86
5.12	Fieldbus Oscilloscope	87
5.12.1	Oscilloscope Recording Settings	87
5.12.2	Start Oscilloscope Recording	88
5.12.3	Trigger Description.....	89
5.12.4	Toolbars and Shortcuts	90
5.13	Firmware Update	92
5.14	FDS Diagnostics	93
5.15	FDS Reporting Wizard	94

6	FOUNDATION Fieldbus Integration	95
6.1	FF Device Structure	95
6.2	Installation	97
6.3	Alarm Integration	98
6.3.1	Alarm Integration with Scheduled Function Block Data	98
6.3.2	Field Diagnostics.....	99
6.3.3	Transducer Block Alarms.....	99
6.4	Operation with Device Descriptions (DD)	99
6.4.1	Configuration.....	100
6.4.2	Configuration Limitations.....	101
6.4.3	Diagnostics	101
6.5	Supported Methods	102
6.5.1	Commissioning Wizard.....	102
6.6	Installation of DGW-FF Device Type Managers with PACTware™.....	103
6.7	Project Setup	105
6.8	HD2-GT-2AD.FF.IO Device Type Manager (DTM).....	106
6.8.1	Online Parameterization and Parameterization.....	106
6.8.2	Commissioning Wizard.....	107
6.8.3	Diagnosis	116
6.8.4	Measured Value	117
6.8.5	Create a Snapshot	121
6.8.6	History Export	122
6.8.6.1	Long-Term History	123
6.8.6.2	Export History.....	123
6.8.6.3	Excel Export Feature	86
6.8.7	Snapshot Explorer.....	125
6.8.7.1	Snapshot Toolbar.....	79
6.8.8	Fieldbus Oscilloscope	126
6.8.9	Tag Import Wizard	126
6.8.9.1	Export Tags from Emerson DeltaV	129
6.8.9.2	Export Tags from Honeywell Experion	130
6.8.9.3	Export Tags from Yokogawa Plant Resource Manager	132
6.8.10	Reporting Wizard.....	135

7	Cabinet I/O	136
7.1	Field Diagnostics	136
7.2	Input Configuration	137
7.2.1	Frequency/Binary Inputs	137
7.2.2	Binary Inputs.....	138
7.2.3	Temperature/Binary Inputs.....	138
7.2.4	Board Humidity	139
7.2.5	Board Temperature	139
7.3	Output Configuration.....	139
7.4	On/Off Controllers.....	140
7.5	FF Channels for the I/O Transducer Block.....	141
7.6	Cabinet Management Applications and I/O Blocks.....	141
7.6.1	Configuring Typical Cabinet Management Applications Manually ..	142
8	Appendix	144
8.1	Measured Values / Parameters	144
8.1.1	Board Type.....	144
8.1.2	Communication Active	144
8.1.3	Current.....	144
8.1.4	Unbalance	144
8.1.5	Active Field Devices.....	145
8.1.6	Communication Error Statistics.....	145
8.1.7	History Recording	145
8.1.8	Jitter.....	145
8.1.9	Noise	147
8.1.10	Polarity	147
8.1.11	Power Supply Voltage	147
8.1.12	Signal Level	148
8.1.13	Trunk Surge Protector Alarm.....	148
8.1.14	Device Coupler Alarms	148
8.1.15	Voltage.....	148
8.1.16	Measured Values by Motherboard Type	148

8.2	HD2-GT-2AD.FF.IO FF Blocks	149
8.2.1	ADM_TB Transducer Block	149
8.2.2	Transducer Block IO_TB	156
8.2.3	Multiple Discrete Input (MDI) Function Block	162
8.2.4	Digital input (DI) Function Block	163
8.2.5	Function Block MAI	164
8.2.6	Function Block MDO	165
8.2.7	Resource Block.....	165
8.3	HD2-GT-2AD.FF.IO FF Channel List	169
8.4	HD2-GT-2AD.FF.IO FF Field Diagnostic Conditions	171
8.5	Expert System Phenomena IDs	172
8.6	DGW-FF Troubleshooting	193
8.7	Discovery and Configuration Tool (PFDCT)	194
8.8	Alarm Hysteresis and Reset	195
8.9	Field Device Handling for PROFIBUS.....	195
8.10	Online and Offline Data Sets.....	196
8.11	HD2-GT-2AD.FF.IO Web Server.....	196
8.12	OPC Server Details	198
8.12.1	OPC-DA Server Name Space	198
8.12.2	OPC-AE Message Data	200

1 Safety

1.1 Validity

The chapter “Safety” is valid as instruction manual.

Specific processes and instructions in this instruction manual require special provisions to guarantee the safety of the operating personnel.

1.2 Symbols Used

This document contains symbols for the identification of warning messages and of informative messages.

Warning Messages

You will find warning messages, whenever dangers may arise from your actions. It is mandatory that you observe these warning messages for your personal safety and in order to avoid property damage.

Depending on the risk level, the warning messages are displayed in descending order as follows:



Danger!

This symbol indicates an imminent danger.

Non-observance will result in personal injury or death.



Warning!

This symbol indicates a possible fault or danger.

Non-observance may cause personal injury or serious property damage.



Caution!

This symbol indicates a possible fault.

Non-observance could interrupt the device and any connected systems and plants, or result in their complete failure.

Informative Symbols



Note

This symbol brings important information to your attention.



Action

This symbol indicates a paragraph with instructions. You are prompted to perform an action or a sequence of actions.

1.3 Target Group, Personnel

Responsibility for planning, assembly, commissioning, operation, maintenance, and dismantling lies with the plant operator.

The personnel must be appropriately trained and qualified in order to carry out mounting, installation, commissioning, operation, maintenance, and dismantling of the device. The trained and qualified personnel must have read and understood the instruction manual.

Prior to using the product make yourself familiar with it. Read the instruction manual carefully.

1.4 Reference to Further Documentation

Observe laws, standards, and directives applicable to the intended use and the operating location. Observe Directive 1999/92/EC in relation to hazardous areas.

The corresponding datasheets, manuals, declarations of conformity, EU-type examination certificates, certificates, and control drawings if applicable (see datasheet) are an integral part of this document. You can find this information under www.pepperl-fuchs.com.

Due to constant revisions, documentation is subject to permanent change. Please refer only to the most up-to-date version, which can be found under www.pepperl-fuchs.com.

1.5 Delivery, Transport, and Storage

Check the packaging and contents for damage.

Check if you have received every item and if the items received are the ones you ordered.

Keep the original packaging. Always store and transport the device in the original packaging.

Always store the device in a clean and dry location. Observe the permissible storage temperature (see datasheet).

1.6 Marking

HD2-DM-A

Fieldbus Power Hub, Advanced Diagnostic Module

Pepperl+Fuchs GmbH

Lilienthalstraße 200, 68307 Mannheim, Germany

Statement of conformity: TÜV 04 ATEX 2500 X

Group, category, type of protection, temperature class:

 II 3 G Ex nA IIC T4 Gc

KT-MB-GT2AD.FF

Advanced Diagnostic Gateway with Ethernet and FF-H1 Interface

Pepperl+Fuchs GmbH

Lilienthalstraße 200, 68307 Mannheim, Germany

Statement of conformity: TÜV 14 ATEX 115980 X

Group, category, type of protection, temperature class:

 II 3 G Ex nA IIC T4 Gc

KT-MB-GT2AD.FF.IO

Advanced Diagnostic Gateway with Ethernet and FF-H1 Interface and I/O

Pepperl+Fuchs GmbH

Lilienthalstraße 200, 68307 Mannheim, Germany

Statement of conformity: TÜV 14 ATEX 115980 X

Group, category, type of protection, temperature class:

Motherboard  II 3 G Ex nA nC IIC T4 Gc , Gateway  II 3 G Ex nA IIC T4 Gc

1.7 Intended Use

The devices are designed to analyze signal and segment parameters for monitoring and measuring of specific system, segment and field device values.

The device is only approved for appropriate and intended use. Ignoring these instructions will void any warranty and absolve the manufacturer from any liability.

The device must only be operated in the specified ambient temperature range and at the specified relative humidity without condensation.

Protection of the personnel and the plant is not ensured if the device is not used according to its intended use.

The device is not suitable for isolating signals in power installations unless this is noted separately in the corresponding datasheet.

1.8 Mounting/Installation

Prior to mounting, installation, and commissioning of the device you should make yourself familiar with the device and carefully read the instruction manual.

The device may be installed in Zone 2.

The device has to be erected in such a way that corresponding to IEC 60079-15, a degree of protection of at least IP54 according to IEC 60529 is achieved.

The device has to be erected in such a way that a pollution degree 2 or less according to IEC 60664-1 is achieved if the device is connected to an intrinsically safe limited voltage according to IEC 60079-11:2011.

The statement of conformity and certificate of compliance of the Fieldbus Power Hub must be observed. It is especially important to pay attention to any special conditions for safe use that are indicated.

Avoid electrostatic charges which could result in electrostatic discharges while installing, operating, or maintaining the device.

If the device has already been operated in general electrical installations, the device may subsequently no longer be installed in electrical installations used in combination with hazardous areas.

Observe the installation instructions according to IEC/EN 60079-14.

Connection or disconnection of energized non-intrinsically safe circuits is only permitted in the absence of a hazardous atmosphere.

1.9 Operation, Maintenance, Repair

Only use operating elements in the absence of a potentially explosive atmosphere.

Only plug and pull the energized module in the absence of a potentially explosive atmosphere.

Connection or disconnection of energized non-intrinsically safe circuits is only permitted in the absence of a potentially explosive atmosphere.

Observe IEC/EN 60079-17 for maintenance and inspection of associated apparatus.

The device must not be repaired, changed, or manipulated. In case of failure, always replace the device with an original device.

1.10 Disposal

The device, built-in components, packaging, and any batteries contained within must be disposed in compliance with the applicable laws and guidelines of the respective country.

2 General Description

Overview

Advanced diagnostics provides a set of monitoring tools for FOUNDATION Fieldbus H1 and PROFIBUS PA that simplify the work with the fieldbus physical layer.

FieldConnex[®] physical layer diagnostics offers the following features:

- The advanced diagnostic module (ADM): It provides comprehensive measurement capabilities for up to 4 segments and is integrated into the FieldConnex[®] Power Hubs.
- The diagnostic gateway (DGW): It connects the ADMs to the process control system (PCS). Several integration options to the PCS are available.
- Software packages consisting of DTMs and auxiliary software provide use-case-driven and easy access to the functionality of the advanced diagnostics and alarm integration with the onsite PCS.
- An optional stand-alone kit can expand the advanced diagnostic features in areas where no FieldConnex[®] Power Hubs are installed.
- Optional cabinet management I/O functionality for the diagnostic gateway.

These features ensure the best possible quality of the fieldbus physical layer through efficient working procedures reducing the amount of effort necessary to commission, monitor and troubleshoot segments. Only a very basic understanding of fieldbus is required to operate the diagnostic tools as they provide comprehensive information and fieldbus expertise to the user.

The advanced diagnostics offer support for one or all three of the following areas of application in process plants:

1. Commissioning

After installation is complete and before loop checking commences, the condition of the segment is checked. A physical layer in good condition is the basis for a successful loop checking and plant commissioning. The ADM and diagnostic manager check the segment with a few mouse clicks and simple-to-use automated procedures. The diagnostic manager records comprehensive physical layer values in a baseline report and suggests limit values to be stored in the ADM.

2. Online Monitoring

The ADM compares actual values to the limits set during commissioning, keeping an "extra set of eyes" on the fieldbus. Warnings indicate early on that a fault has occurred or that the quality of the installation is degrading. Proactive corrective action is possible preventing unwanted plant shutdowns.

3. Troubleshooting

Messages in plain language help the maintenance staff to find possible causes for a problem. Repair work is planned and performed only when necessary. This significantly reduces time to repair and time spent in the field.

Additional tools for more detailed analysis complete the advanced diagnostics:

- Automated reports in electronic format
- Fieldbus oscilloscope
- Long-term history for monitoring changes
- Storage of configuration and historical data
- Export functions to other spreadsheets or data warehouse

2.1 General System Layout and PCS Integration

The advanced diagnostics system consists of diagnostic gateways (DGW) and advanced diagnostic modules (ADM). The ADMs are mounted on FieldConnex[®] Power Hubs or a stand-alone motherboard and are connected to each other and to the GDW using a dedicated diagnostic bus. The figure below shows an installation example.

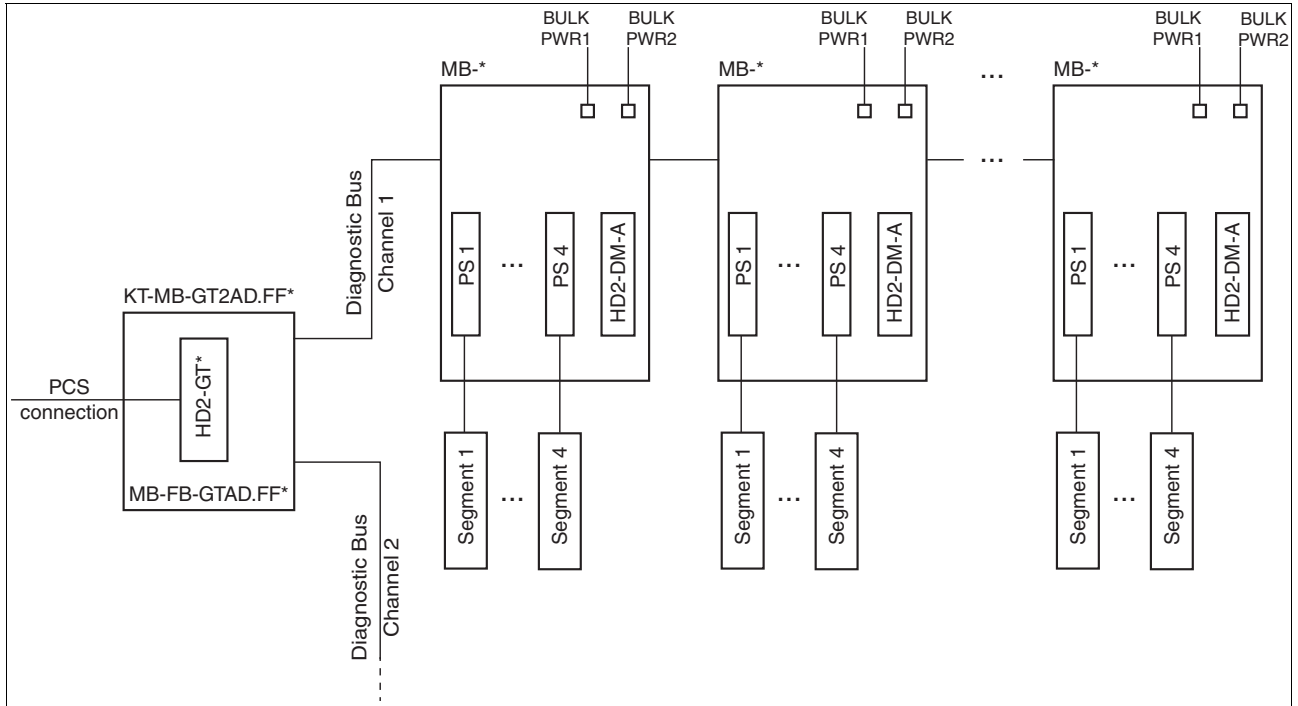

Figure 2.1 System topology with diagnostic gateway, Power Hubs and advanced diagnostic modules

Details for the installation are described for:

- FieldConnex[®] Power Hubs in section see chapter 4.1
- Stand-alone diagnostic kits in section see chapter 4.2

The PCS connection is actually the choice of the PCS integration method. The following possibilities are available:

- FDS/OPC integration: A server is running on a PC that provides status information to the PCS via OPC. FDT DTMs are available for detailed diagnostics, monitoring, and commissioning purposes. This integration consists of the following parts:

- FDS server (the OPC server)
- Diagnostic manager FDT/DTMs

For many PCS, so-called ADM integration packages exist. These packages provide step-by-step guides and additional software tools to seamlessly integrate the FieldConnex[®] advanced physical layer diagnostics in a PCS. ADM projects including segment and field device tags are built directly from the PCS database. Alarming and the diagnostic manager are tightly integrated into the PCS asset management. Manual OPC configuration etc. is not required. Check www.pepperl-fuchs.com for available ADM integration packages.

For FDS/OPC integration, see chapter 5

- FOUNDATION Fieldbus integration for diagnostic gateway FF field device. This integration consists of the following parts:
 - DGW-FF device description (DD)
 - Optional: FDT DTM for DGW-FF field device

For FOUNDATION Fieldbus integration, see chapter 6

- PROFIBUS Power Hub integration for systems that use the transparent Pepperl+Fuchs Segment Couplers. This integration is described in detail in the PROFIBUS Power Hub manual.
- Simple integrations can be implemented using a volt-free contact. Typically, this integration will be used with one of the other solutions. Alarming during segment operation is done using the volt-free contact; commissioning and troubleshooting are done using one of the other integration methods. For more information, see chapter 4.4.

2.2 General Terms and Functions for Advanced Diagnostics

Overview

Each segment monitored by advanced diagnostics (AD) has 1 of 3 states:

- Non-commissioned

This is the initial state of segments in the ADM. All diagnostics in this state are based on the following:

- Limits defined by the fieldbus standard IEC/EN 61158-2 or
- Limits calculated from information on the segment topology, e.g., trunk length, type of device couplers used

This mode is used to commission a segment and guarantees an error-free installation.

- Commissioned

A segment is set to commissioned if an initial checkout was executed to verify an error-free installation. In the commissioned mode, the segment is validated against limits defined during the commissioning procedure. These limits can be specified manually for each segment, but typically the commissioning wizard is used. For more information on the commissioning wizard, see chapter 2.2.2.

- Disabled

The segment is a spare segment and not used yet. The advanced diagnostics is disabled for this segment.

The overall segment and each single diagnostic value are classified by the ADM in the following way:

Not Commissioned



Excellent:

All values are within the specification limits with an excellent safety margin.



Good:

The value is within the specification limits but the safety margin is reduced. Values within IEC 61158-2 limits, but with small safety margins or values are not matching with expected values of the topology.



Out of specification:

The value exceeds the specification limits. At least one value violated an IEC 61158-2 limit.

Commissioned



No Error:

The value is within the commissioned limits.



Maintenance Required:

The value is outside the commissioned limits (but still inside allowed range). At least one value changed since commissioning.

**Out of Specification:**

The value exceeds the specification limits. At least one value violated an IEC 61158-2 limit.

**Failure:**

Field devices that were active on the fieldbus during commissioning and are not active anymore are marked as fail in the user interfaces. The overall segment is classified as out of specification. If any hardware failure of the ADM is detected or if the diagnostic gateway cannot communicate with the ADM this is also shown as Fail.

2.2.1 Expert System

FieldConnex[®] advanced physical layer diagnostics includes an expert system. This expert system analyzes all measured values and provides detailed diagnostic messages about any found issue on the fieldbus, the root causes of the issue and actions necessary to solve them. This way, the user is relieved from the tedious and time-consuming analysis of all measurements of the ADM. The expert system takes the segment state (commissioned, non-commissioned) into account and provides optimized messages for the 2 different use cases.

2.2.2 Commissioning Wizard

The commissioning wizard is a tool for a fast and easy system setup with advanced diagnostic modules (ADM). It is the recommended way to perform segment commissioning.

The wizard guides you through segment commissioning and determines system and segment data of your fieldbus installation. The expert system analyzes this data and helps you to solve any issues found. A comprehensive report on the status of the segment at the time is automatically generated. Based on this information, the commissioning wizard proposes limits for all system, segment, and field device alarm values. If necessary, you can edit the limit values or store them on the ADM. After the commissioning wizard is completed successfully, the ADM is switched to the "commissioned mode" and is ready for plant real-time monitoring.

2.2.3 Diagnostic Gateway Mode (DGW Mode)

The diagnostic gateway (DGW) can be used for the OPC and DTM integration as well as for the Foundation Fieldbus integration. Only 1 of the 2 types of integration can be used at a time. The DGW mode must be set to "FDS" or "FF", depending on the selected integration solution. When a DGW is installed the first time, it automatically selects the DGW mode depending on whether an FF host or an FDS is connecting to the gateway. In order to change the integration later on, the DGW mode can be set manually, either via DTMs or via the DGW built-in web server.

2.2.4 Field Device Handling

The ADM differentiates between "configured" and "unconfigured" field devices. Field devices are identified based on the device address.

- Configured field devices

The ADM features a list of field devices that are labeled "configured field devices". All field devices (and the hosts) belonging to the segment are added to the configured field devices list. Field devices included in this list can have a tag, limits for their signal levels, as well as alarm settings for field-device-specific alarms. The commissioning wizard automatically includes all field devices that are active during the commissioning procedure in the configured field devices list. If field devices are active on the fieldbus and are not in the configured field devices list or devices in the list are inactive (i.e., not communicating), the ADM issues an alarm.

- Unconfigured field devices

All devices that are active on the fieldbus, but are not in the configured field devices list are labeled "unconfigured field devices". All measured physical layer data (e.g., signal levels) is shown for this device, but no alarms etc. are associated with this device.

3 Product Description

3.1 HD2-DM-A - Advanced Diagnostic Module

General Overview

The advanced diagnostic module (ADM) is a plug-in module for FieldConnex[®] Power Hubs. Together with the diagnostic gateway and the diagnostic manager software solutions, it supports commissioning, online monitoring and troubleshooting of FOUNDATION Fieldbus or PROFIBUS PA segments in FieldConnex[®] Power Hub installations. It measures the physical characteristics of the fieldbus installation and the fieldbus communication signals. This data is compared to configurable limits and evaluated by an expert system. The results of the examination are provided as alarm information and a detailed analysis of detected issues.

3.1.1 Assembly

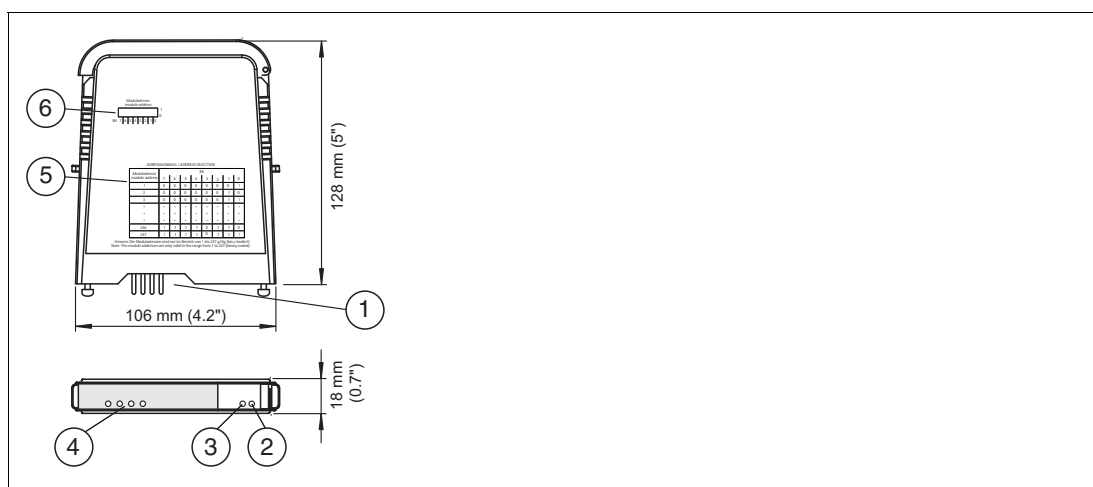

Figure 3.1 Overview HD2-DM-A

- 1 Plug connections to motherboard
- 2 LED green PRI Power
- 3 LED green SEC Power
- 4 LED Seg 1 ... 4
- 5 Address selection overview
- 6 DIP switch for device address

3.1.2 Technical Data

HD2-DM-A

Supply	
Rated voltage	19.2 ... 35 V
Rated current	110 ... 30 mA
Power loss	max. 2 W
Fieldbus interface	
Number of segments	4
Fieldbus type	FOUNDATION Fieldbus/PROFIBUS PA
Rated voltage	9 ... 32 V
Indicators/operating means	

LED PRI PWR	green: on, primary bulk power supply connected
LED SEC PWR	green: on, secondary bulk power supply connected
LED Seg 1...4	yellow: bus activity; red 2 Hz flashing: alarm; red: hardware error
Fault signal	VFC alarm 1 A, 50 V DC, normally closed
DIP-switch	diagnostic address 1...247, binary coded
Interface	
Interface type	diagnostic bus: RS 485
Electrical isolation	
Fieldbus segment/Fieldbus segment	functional insulation acc. to IEC 62103, rated insulation voltage 50 V _{eff}
Fieldbus segment/Supply	functional insulation acc. to IEC 62103, rated insulation voltage 50 V _{eff}
Directive conformity	
Electromagnetic compatibility	
Directive 2004/108/EC	EN 61326-1:2013
Standard conformity	
Electromagnetic compatibility	NE 21:2011
Degree of protection	IEC 60529
Shock resistance	EN 60068-2-27
Vibration resistance	EN 60068-2-6
Corrosion resistance	acc. to ISA-S71.04-1985, severity level G3
Ambient conditions	
Ambient temperature	-40 ... 70 °C (-40 ... 158 °F)
Storage temperature	-40 ... 85 °C (-40 ... 185 °F)
Relative humidity	< 95 % non-condensing
Shock resistance	15 g 11 ms
Vibration resistance	1 g , 10 ... 150 Hz
Pollution Degree	max. 2, according to IEC 60664
Corrosion resistance	acc. to ISA-S71.04-1985, severity level G3
Mechanical specifications	
Connection type	Motherboard specific
Core cross-section	Motherboard specific
Housing material	Polycarbonate
Housing width	18 mm
Housing height	106 mm
Housing depth	128 mm
Degree of protection	IP20
Mass	approx. 100 g
Mounting	motherboard mounting
Mating cycles	100
Data for application in connection with Ex-areas	

Statement of conformity	TÜV 04 ATEX 2500 X
Group, category, type of protection, temperature class	Ⓔ II 3 G Ex nA IIC T4 Gc
Directive conformity	
Directive 94/9/EC	EN 60079-0:2012 , EN 60079-11:2012 , EN 60079-15:2010
International approvals	
FM approval	CoC 3024816, CoC 3024816C
Approved for	Class I, Division 2, Groups A, B, C, D, T4 / Class I, Zone 2, AEx/Ex nA IIC T4
IECEX approval	IECEX TUN 13.0038 X
Approved for	Ex nA IIC T4 Gc
Certificates and approvals	
Marine approval	DNV A-10798
Patents	This product may be covered by the following patent: US7,698,103
General information	
Supplementary information	Statement of Conformity, Declaration of Conformity, Attestation of Conformity and instructions have to be observed where applicable. For information see www.pepperl-fuchs.com .

3.1.3

LED Indication

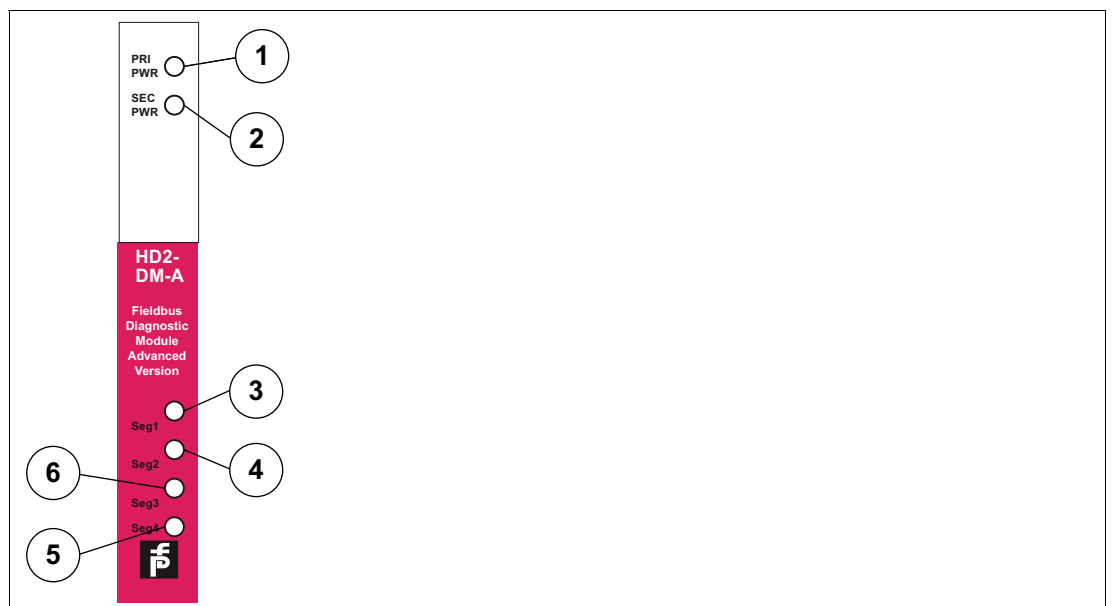

Figure 3.2 LED indication

- 1 LED: Primary power connection
- 2 LED: Secondary power connection
- 3 LED: Status segment 1
- 4 LED: Status segment 2
- 5 LED: Status segment 3
- 6 LED: Status segment 4

LED Indication	Fault Type	Remedy
PRI PWR or SEC PWR LEDs are off.	Supply power failure, possible reasons: <ul style="list-style-type: none"> No primary and/or secondary supply power is available Supply power < 19.2 V Supply power > 35 V (32 V if at least 1 non-isolated power module is plugged-in or configured) 	Connect diagnostic PC and carry out a complete system diagnostics: <ul style="list-style-type: none"> Bulk power supply switched on and healthy? Verify that the wiring is secure: <ul style="list-style-type: none"> Tug on the wires/cable clamps Measure the DC voltage at the terminal block connector to the bulk power supply
1 segment LED is flashing yellow (on/off with 2 Hz).	A segment/field device maintenance required alarm is active.	Connect diagnostic PC and carry out a complete system diagnostics: <ul style="list-style-type: none"> DC unbalance? Jitter level too high? Noise level too high? Bus segment ... <ul style="list-style-type: none"> ... badly terminated? ... miswired (shield connections)? ... short-circuit overload? Power supply/conditioner modules healthy and correctly mounted?
1 segment LED is flashing red (on/off with 2 Hz).	Any segment/field device alarm is active.	
All segment LEDs are flashing yellow (on/off with 2 Hz).	A system maintenance required alarm is active.	Connect diagnostic PC and carry out a complete system diagnostics: <ul style="list-style-type: none"> Bulk power supply voltage correct? Board type configuration correct? Board redundancy configuration correct?
All segment LEDs are flashing red (on/off with 2 Hz).	Any system alarm is active.	
Any (or all) segment LEDs are constantly lit red.	A hardware fault inside HD2-DM-A is detected.	-

3.1.4 Mounting the Diagnostic Module



Warning!

Hardware Damage

If you plug the diagnostic module HD2-DM* into the wrong connection slot, the module or the motherboard may be damaged.

The Power Hub motherboard features a special connection slot for diagnostic modules labeled "Diagnostic Module only". Use this slot only.



Mounting of HD2-DM* Modules on the Motherboard

To install a new module on the motherboard, proceed as follows:

1. Carefully center the polarization holes and mate the two connectors, then gently press down the module.
2. Push down the red Quick Lok bars on each side of the module to fix it to the panel.

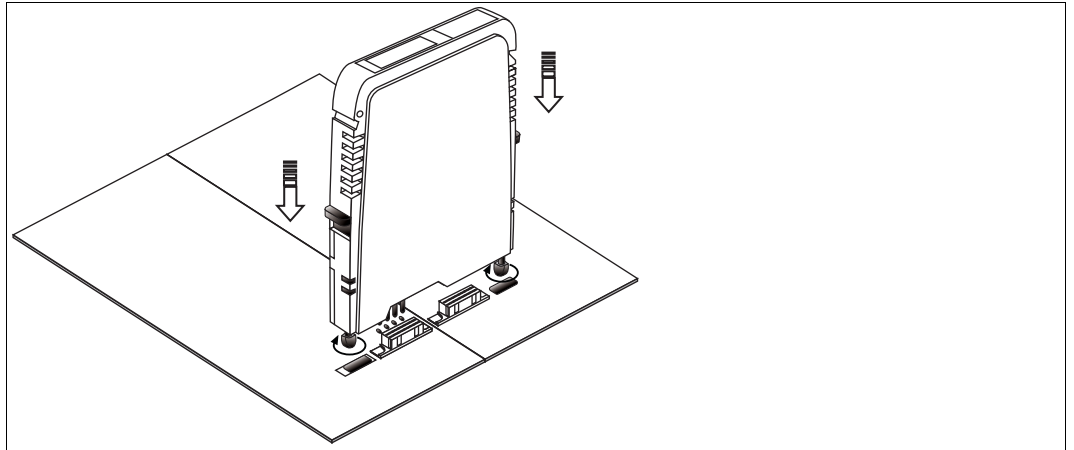

Figure 3.3 Mounting HD2-DM*

↳ The new module has been installed.



Dismounting Modules from the Motherboard

To dismount a module from the motherboard, proceed as follows:

Pull up the red Quick Lok bars on each side of the module and carefully lift off the entire module.

↳ The module has been removed from the motherboard.

3.2

KT-MB-DMA - Advanced Diagnostic Module, Kit for Stand-Alone Operation

General Overview

The stand-alone diagnostic kit consists of an HD2-DM-A plug-in module (see chapter 3.1) and a motherboard to connect the HD2-DM-A to up to 4 segments. It is specially designed to lead the advanced diagnostic features in areas where continuous monitoring of the physical layer is crucial and no FieldConnex[®] Power Hubs are installed.

3.2.1 Assembly

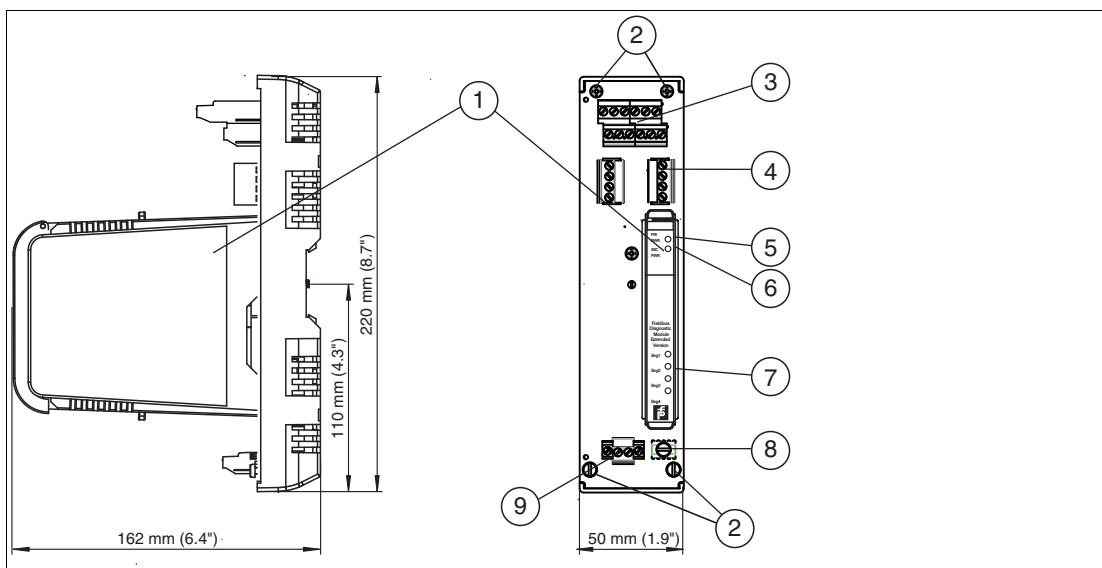

Figure 3.4 Overview KT-MB-DMA

1		Advanced diagnostic module (ADM)
2		Mounting screws
3		Connections for segments
4		Diagnostic bus
5		PRI LED green: Primary power
6		SEC LED green: Secondary power
7		LEDs Seg 1 ... 4
8		Shield/ground connection clamp
9		Connections for bulk power supply

3.2.2 Technical Data

The technical data below refers to the stand-alone motherboard. For technical data of the HD2-DM-A diagnostic module, see chapter 3.1.2.

KT-MB-DMA

Supply	
Rated voltage	19.2 ... 35 V
Rated current	110 ... 30 mA
Power loss	max. 2 W
Fieldbus interface	
Number of segments	4
Fieldbus type	FOUNDATION Fieldbus/PROFIBUS PA

2020-11

Indicators/operating means	
LED PRI PWR	green: on, primary bulk power supply connected
LED SEC PWR	green: on, secondary bulk power supply connected
LED Seg 1...4	yellow: bus activity; red 2 Hz flashing: alarm; red: hardware error
Fault signal	VFC alarm 1 A, 50 V DC, normally closed
DIP-switch	diagnostic address 1...247, binary coded
Interface	
Interface type	diagnostic bus: RS 485
Directive conformity	
Electromagnetic compatibility	
Directive 2004/108/EC	EN 61326-1:2006
Standard conformity	
Electromagnetic compatibility	NE 21
Degree of protection	IEC 60529
Shock resistance	EN 60068-2-27
Vibration resistance	EN 60068-2-6
Ambient conditions	
Ambient temperature	-40 ... 60 °C (-40 ... 140 °F)
Storage temperature	-40 ... 85 °C (-40 ... 185 °F)
Relative humidity	< 95 % non-condensing
Shock resistance	15 g 11 ms
Vibration resistance	1 g, 10 ... 150 Hz
Mechanical specifications	
Connection type	screw terminals
Core cross-section	2.5 mm ²
Housing material	Polycarbonate
Housing width	50 mm
Housing height	220 mm
Housing depth	162 mm
Degree of protection	IP20
Mass	approx. 290 g
Mounting	DIN mounting rail
International approvals	
FM approval	CoC 3024816, CoC 3024816C
Approved for	Class I, Division 2, Groups A, B, C, D, T4 / Class I, Zone 2, AEx/Ex nA IIC T4

3.2.3 Mounting the Stand-Alone Kit and the Advanced Diagnostic Module

For mounting the HD2-DM-A diagnostic module, see chapter 3.1.4.



Mounting Fieldbus Motherboards on the DIN Mounting Rail

In order to mount a motherboard on a DIN mounting rail, proceed as follows:

1. Place the motherboard on the DIN mounting rail.
2. Tighten the fastening screw to attach the motherboard on the DIN mounting rail.

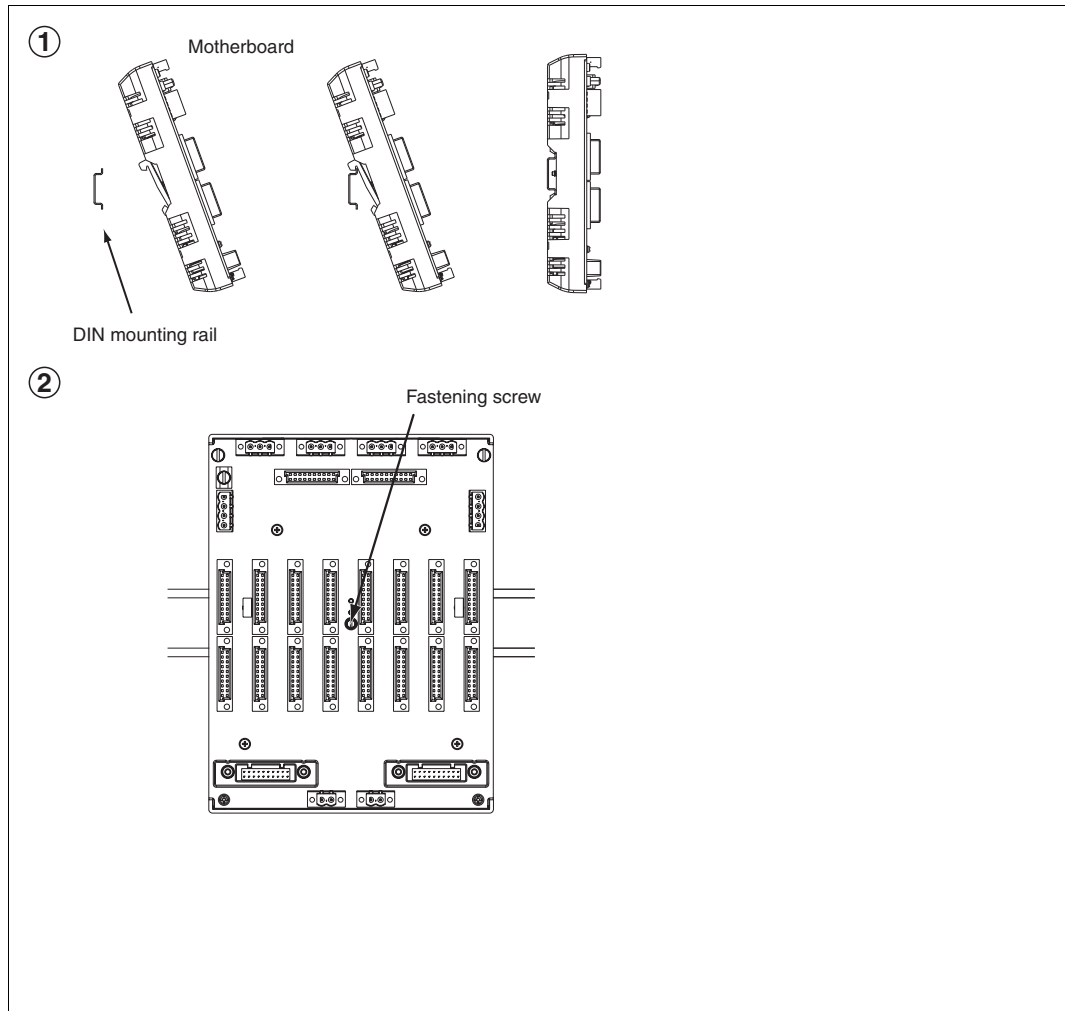

↳ The motherboard has been mounted.

3.3 KT-MB-GT2AD.FF - Diagnostic Gateway, Kit with Motherboard

General Overview

The FieldConnex[®] Diagnostic Gateway collects all data from the advanced diagnostic module (ADM) and provides interfaces to access the data from the diagnostic manager and PCS.

- **Ethernet**

Allows access to the ADMs for the diagnostic manager and the FDS/OPC server. It is mainly used for the FDS/OPC integration, but can also be used with the FOUNDATION Fieldbus H1 interface to enhance the functionality of the diagnostic manager and to access the FOUNDATION Fieldbus device locally using a mobile computer.

- **FOUNDATION Fieldbus H1**

Provides the core diagnostic data of up to 16 HD2-DM-A ADMs as FOUNDATION Fieldbus H1 device. The Ethernet interface can be used in addition to the FF-H1 interface to enhance the functionality of the diagnostic manager and to access the FOUNDATION Fieldbus device locally using a mobile computer.

- **Common alarm output**

The common alarm output can be used to report the ADM alarms as a volt-free contact to a PCS input.

The gateway is seamlessly integrated into the FieldConnex[®] advanced physical layer solution and provides many features for a fast and easy installation and setup of the advanced diagnostics.



Note

The diagnostic gateway FF-H1 connection must never be connected to device couplers like the Pepperl+Fuchs Segment Protectors or FieldBarriers.

The diagnostic gateway must be connected directly to the trunk.

For best performance, we recommend using a separate FF-H1 diagnostic segment for diagnostic gateways. Scheduled FB data must be kept to a minimum for this segment.

3.3.1 Assembly

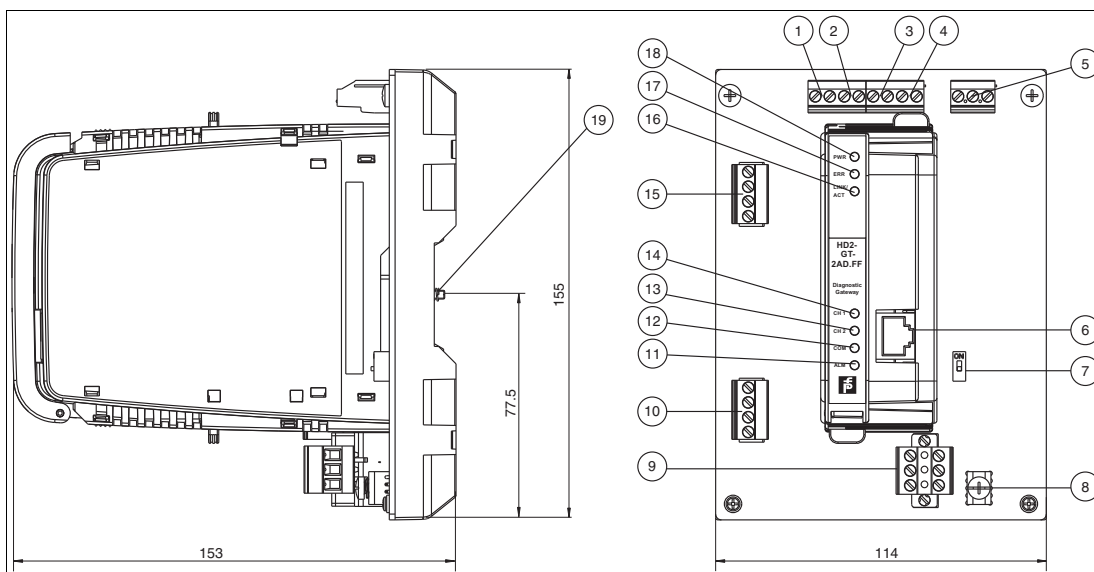

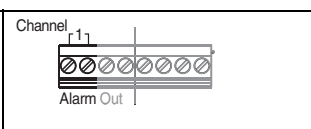
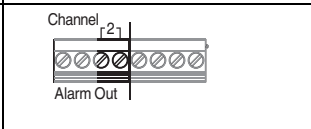
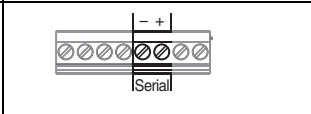
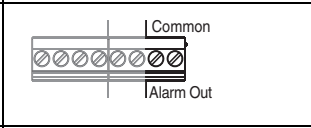
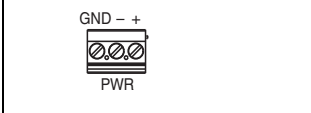
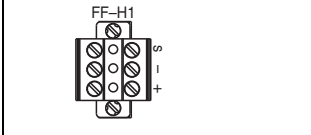
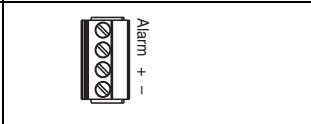
<p>1</p> 	<p>Channel 1 Alarm Out</p>	<p>Output I: Alarm output diagnostic bus channel 1, volt-free contact, NC contact See chapter 4.4.1</p>
<p>2</p> 	<p>Channel 2 Alarm Out</p>	<p>Output II: Alarm output diagnostic bus channel 2, volt-free contact, NC contact See chapter 4.4.1</p>
<p>3</p> 	<p>Serial</p>	<p>Serial, not used</p>
<p>4</p> 	<p>Common Alarm Out</p>	<p>Output III: Common alarm, volt-free contact, NC contact See chapter 4.4.1</p>
<p>5</p> 	<p>GND - + PWR</p>	<p>Bulk power supply connection</p>
<p>6</p>		<p>Ethernet, 8-pin RJ45 socket</p>
<p>7</p>		<p>Enable/disable simulation switch</p>
<p>8</p>		<p>Grounding terminal</p>
<p>9</p> 	<p>FF-H1</p>	<p>FF-H1</p>
<p>10</p> 	<p>Alarm + -</p>	<p>Diagnostic bus channel 2</p>
<p>11</p>		<p>LED: Common alarm output</p>
<p>12</p>		<p>LED: COM, not used</p>

2020-11

13		LED: Diagnostic bus channel 2 activity
14		LED: Diagnostic bus channel 1 activity
15		Diagnostic bus channel 1
16		LED: LINK/ACT
17		LED: Error
18		LED: Power supply
19		Mounting screw (located under diagnostic gateway)

Cable and Connection Information

- Alarm output / serial / bulk power supply:
 - Cross section: 0.2 mm² ... 4 mm² fixed, 0.2 mm² ... 2.5 mm² flexible
 - Wire stripping length: 8 mm
 - Torque: 0.5 Nm ... 0.6 Nm
- FF-H1 / diagnostic bus channels 1+2:
 - Cross section: 0.2 mm² ... 2.5 mm² fixed and flexible
 - Wire stripping length: 7 mm
 - Torque: 0.5 Nm ... 0.6 Nm

3.3.2

Technical Data

KT-MB-GT2AD.FF

Supply	
Rated voltage	19.2 ... 35 V DC SELV/PELV
Rated current	120 ... 70 mA
Power loss	max. 2.5 W
Fieldbus interface	
Fieldbus type	FOUNDATION Fieldbus
Physical layer profile	profile type 114
ITK version	6
Implementation	resource block 1x RS function block 4x MDI, 1x MDO, 1x MAI, 1x DI transducer block 16x ADM TB, 1x IO TB
Firmware update	Ethernet
Polarity	polarity-sensitive
Rated voltage	9 ... 35 V SELV/PELV
Rated current	0 mA
Ethernet Interface	
Port	100 BASE-TX
Protocol	TCP/IP and UDP/IP
Services	ICMP , DHCP , AutoIP , HTTP

Connection type	RJ-45 socket, 8-pin
Transfer rate	100 MBit/s
Diagnostic Bus	
Number of Diagnostic Bus Channels	2
Number of Diagnostic Modules/Channel	31 Using Ethernet Interface , 8 Using Fieldbus Interface
Termination	integrated
Cable length/Channel	30 m
Indicators/operating means	
LED ERR	red: Hardware fault
LED PWR	green: Power on
LINK/ACT	yellow
CH1, CH2	yellow: diagnostic bus activity
Outputs	
Output I	alarm output diagnostic bus channel 1 , volt-free contact , NC contact
Voltage	50 V DC
Current	max. 1 A
Output II	alarm output diagnostic bus channel 2 , volt-free contact , NC contact
Voltage	50 V DC
Current	max. 1 A
Output III	common alarm , volt-free contact , NC contact
Voltage	50 V DC
Current	max. 1 A
Electrical isolation	
All circuits/FE	functional insulation acc. to IEC 62103, rated insulation voltage 50 V _{eff}
Output I, II/other circuits	functional insulation acc. to IEC 62103, rated insulation voltage 250 V _{eff}
Ethernet/Supply	functional insulation acc. to IEC 62103, rated insulation voltage 50 V _{eff}
Ethernet/other circuits	functional insulation acc. to IEC 62103, rated insulation voltage 50 V _{eff}
Fieldbus/other circuits	functional insulation acc. to IEC 62103, rated insulation voltage 50 V _{eff}
Diagnostic Bus/other circuits	functional insulation acc. to IEC 62103, rated insulation voltage 50 V _{eff}
Directive conformity	
Electromagnetic compatibility	
Directive 2004/108/EC	EN 61326-1:2013
Low voltage	
Directive 73/23/EEC	EN 61010
Standard conformity	
Electrical isolation	IEC 62103

Electromagnetic compatibility	NE 21
Degree of protection	IEC 60529
Fieldbus standard	IEC 61158-2
Climatic conditions	DIN IEC 721
Shock resistance	EN 60068-2-27
Vibration resistance	EN 60068-2-6
Ethernet	IEEE 802.3
Ambient conditions	
Ambient temperature	-40 ... 60 °C (-40 ... 140 °F)
Storage temperature	-40 ... 85 °C (-40 ... 185 °F)
Relative humidity	< 95 % non-condensing
Shock resistance	15 g 11 ms
Vibration resistance	1 g , 10 ... 150 Hz
Pollution Degree	max. 2, according to IEC 60664
Corrosion resistance	acc. to ISA-S71.04-1985, severity level G3
Mechanical specifications	
Housing material	Polycarbonate
Housing width	see dimensions
Housing height	see dimensions
Housing depth	see dimensions
Degree of protection	IP20
Mass	470 g
Mounting	DIN rail mounting
Data for application in connection with Ex-areas	
Statement of conformity	TÜV 14 ATEX 115980 X
Group, category, type of protection, temperature class	⊕ Ex II 3 G Ex nA IIC T4 Gc
Directive conformity	
Directive 94/9/EC	EN 60079-0:2012 , EN 60079-11:2012 , EN 60079-15:2010
International approvals	
IECEx approval	IECEx TUN 14.0003X
Approved for	Ex nA IIC T4 Gc
General information	
Supplementary information	Statement of Conformity, Declaration of Conformity, Attestation of Conformity and instructions have to be observed where applicable. For information see www.pepperl-fuchs.com .

3.3.3 LED Indication



- 1 Power supply
- 2 Error
- 3 Link/Activity
- 4 Diagnostic bus channel 1
- 5 Diagnostic bus channel 2
- 6 COM, not used
- 7 Alarm

LED Indication	Description
PWR lights up green	The power supply is connected properly
ERR lights up red	A hardware failure is detected
ERR flashes red	An ADM conflict is detected (same address on both diagnostic bus channels)
LINK/ACT lights up yellow	A link is established
LINK/ACT flashes yellow	Ethernet activity
CH1/CH2 lights up yellow	FF mode: ADMs are detected with an address between 1 ... 16 FDS/OPC mode: <ul style="list-style-type: none"> • FDS is connected • DTM communication to at least 1 device in the last 3 seconds • At least 1 configured device is active
CH1/CH2 flashes yellow	FF mode: ADMs are detected with an address range outside 1 ... 16 FDS/OPC mode: <ul style="list-style-type: none"> • FDS is not connected • At least 1 device is active (while scanning the range of all valid MODBUS addresses)
ALM flashes red	Common alarm output is active (open)

2020-11

3.4 KT-MB-GT2AD.FF.IO - Diagnostic Gateway, Kit with I/O Motherboard

General Overview

The FieldConnex[®] Diagnostic Gateway collects all data from the advanced diagnostic module (ADM) and provides interfaces to access the data from the diagnostic manager and PCS.

- **Ethernet**

Allows access to the ADMs for the diagnostic manager and the FDS/OPC server. It is mainly used for the FDS/OPC integration, but can also be used with the FOUNDATION Fieldbus H1 interface to enhance the functionality of the diagnostic manager and to access the FOUNDATION Fieldbus device locally using a mobile computer.

- **FOUNDATION Fieldbus H1**

Provides the core diagnostic data of up to 16 HD2-DM-A ADMs as FOUNDATION Fieldbus H1 device. The Ethernet interface can be used in addition to the FF-H1 interface to enhance the functionality of the diagnostic manager and to access the FOUNDATION Fieldbus device locally using a mobile computer.

- **Common alarm output**

The common alarm output can be used to report the ADM alarms as a volt-free contact to a PCS input.

The gateway is seamlessly integrated into the FieldConnex[®] advanced physical layer solution and provides many features for a fast and easy installation and setup of the advanced diagnostics.

Compared to the KT-MB-GT2AD.FF diagnostic gateway the KT-MB-GT2AD.FF.IO uses a different motherboard with I/O functionality. This includes binary inputs, binary outputs, frequency inputs, temperature inputs and integrated sensors for temperature and humidity. These inputs and outputs are primarily designed for cabinet management applications like heater or cooling control and door open alarms. The cabinet management application is supported by additional control features like on/off controllers in the diagnostic gateway.



Note



The diagnostic gateway FF-H1 connection must never be connected to device couplers like the Pepperl+Fuchs Segment Protectors or FieldBarriers.

The diagnostic gateway must be connected directly to the trunk.

For best performance, we recommend using a separate FF-H1 diagnostic segment for diagnostic gateways. Scheduled FB data must be kept to a minimum for this segment.

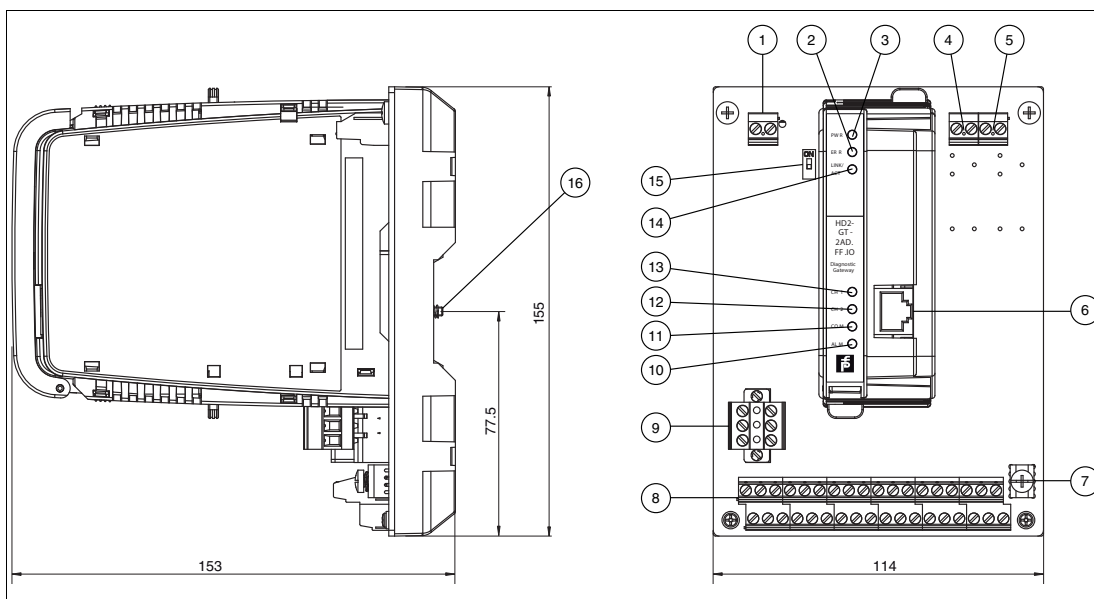
3.4.1 Assembly

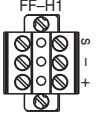

1		Bulk power supply
2		LED: Error
3		LED: Power supply
4		Output I, selectable: Diagnostic bus CH 1, relay, NO contact
5		Output II, selectable: Diagnostic bus CH 2, relay, NO contact
6		Ethernet, 8-pin RJ45 socket
7		Grounding terminal
8		I/O terminal block
9		FF-H1
10		LED: Common alarm output
11		LED: COM, not used
12		LED: Diagnostic bus channel 2 activity
13		LED: Diagnostic bus channel 1 activity
14		LED: LINK/ACT
15		Enable/disable simulation switch
16		Mounting screw (located under diagnostic gateway)

2020-11

I/O Terminal Block

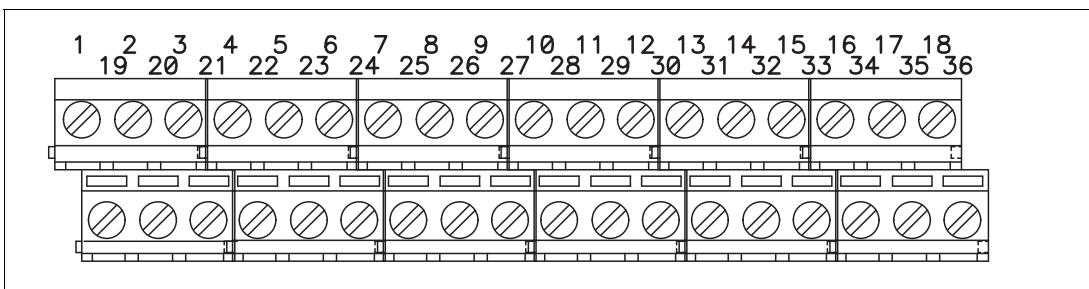

1	+	Input I Frequency input 1 Binary/ NAMUR input 1	19	+	Output I Diagnostic bus CH 1, Output 1
2	-		20	-	
3	+	Input II Frequency input 2 Binary/ NAMUR input 2	21	GND	Ground
4	-		22	A (+)	
5	+	Input III Binary/ NAMUR input 3	23	B (-)	Input V Diagnostic bus CH 1, Binary/NAMUR input 5
6	-		24	GND	
7	+	Input IV Binary/ NAMUR input 4	25	+	Output II Diagnostic bus CH 2, Output 2
8	-		26	-	
9	+	Input VII Temperature input 1 Binary/ NAMUR input 7	27	GND	Ground
10	H		28	A (+)	
11	L		29	B (-)	
12	-		30	GND	
13	GND	Ground	31	+	Serial, not used
14	+	Input VIII Temperature input 2 Binary/ NAMUR input 8	32	-	Serial, not used
15	H		33	GND	Ground
16	L		34	A	Output III Common alarm output 1 Output 3 See chapter 4.4.1
17	-		35	B	
18	GND	Ground	36	GND	Ground

Cable and Connection Information

- Relay contact output 1+2 / bulk power supply:
 - Cross section: 0.2 mm² ... 4 mm² fixed, 0.2 mm² ... 2.5 mm² flexible
 - Wire stripping length: 8 mm
 - Torque: 0.5 Nm ... 0.6 Nm
- FF-H1:
 - Cross section: 0.2 mm² ... 2.5 mm² fixed and flexible
 - Wire stripping length: 7 mm
 - Torque: 0.5 Nm ... 0.6 Nm
- I/O terminal block:
 - Cross section: 0.14 mm² ... 1.5 mm² fixed and flexible
 - Wire stripping length: 6 mm
 - Torque: 0.5 Nm ... 0.6 Nm

All grounding terminals are connected to the shield/screen grounding terminal of the motherboard. The grounding terminals can be used to connect a shield of the I/O or diagnostic bus cables to ground.

Input V and Input VI

Each diagnostic bus is built of 2 communication lines (+, -) and 2 alarm lines (A, B). If the volt-free contact from the ADM (see chapter 4.4) is not used the volt-free relay contact inputs can be used as additional binary/NAMUR inputs.

Input VII and Input VIII

The temperature inputs support Pt100 with 4-wire connection only. The PT100s are connected in the following way:



3.4.2

Technical Data

KT-MB-GT2AD.FF.IO



Supply	
Rated voltage	19.2 ... 35 V DC SELV/PELV
Rated current	210 ... 120 mA
Power loss	max. 4.2 W
Fieldbus interface	
Fieldbus type	FOUNDATION Fieldbus
Physical layer profile	profile type 114
ITK version	6
Implementation	resource block 1x RS function block 4x MDI, 1x MDO, 1x MAI, 1x DI transducer block 16x ADM TB, 1x IO TB
Firmware update	Ethernet
Polarity	polarity-sensitive
Rated voltage	9 ... 35 V SELV/PELV
Rated current	0 mA
Ethernet Interface	
Rated voltage	max. 35 V SELV/PELV
Port	100 BASE-TX
Protocol	TCP/IP and UDP/IP
Services	ICMP , DHCP , AutoIP , HTTP
Connection type	RJ-45 socket, 8-pin
Transfer rate	100 MBit/s
Diagnostic Bus	
Connection	only for the connection to protected circuits
Rated voltage	max. 35 V
Number of Diagnostic Bus Channels	2

Number of Diagnostic Modules/Channel	31 Using Ethernet Interface , 8 Using Fieldbus Interface
Termination	integrated
Cable length/Channel	30 m
Indicators/operating means	
LED ERR	red: Hardware fault
LED PWR	green: Power on
Fault signal	buzzer on
LINK/ACT	yellow
CH1, CH2	yellow: diagnostic bus activity
Inputs	
Input I, II	
Input type	selectable: Frequency input , NAMUR/mechanical contact
Frequency	
Input frequency	0.3 Hz to 1 kHz
Connection	only passive load
Rated voltage	max. 35 V
Pulse duration	min. 50 µs
Accuracy	± 1 %
Cable length	max. 30 m
Line fault detection	lead breakage , short-circuit
NAMUR	
Input III, IV	NAMUR sensor according to DIN EN 60947-6 or mechanical contact
Sensor type	NAMUR sensor according to DIN EN 60947-6
Connection	only passive load
Rated voltage	max. 35 V
Switching frequency	10 Hz
Cable length	max. 30 m
Line fault detection	lead breakage , short circuit
Input III, IV	
Input type	NAMUR/mechanical contact
NAMUR	
Sensor type	NAMUR sensor according to DIN EN 60947-6
Connection	only passive load
Rated voltage	max. 35 V
Switching frequency	10 Hz
Cable length	max. 30 m
Line fault detection	lead breakage , short circuit
Input V	
Input type	selectable: diagnostic bus CH 1 alarm input , NAMUR/mechanical contact
Alarm Input	

Connection	only passive load
Rated voltage	max. 35 V
Cable length	max. 30 m
Line fault detection	lead breakage , short-circuit
NAMUR	
Sensor type	NAMUR sensor according to DIN EN 60947-6
Connection	only passive load
Rated voltage	max. 35 V
Switching frequency	10 Hz
Cable length	max. 30 m
Line fault detection	lead breakage , short circuit
Input VI	
Input type	selectable: diagnostic bus CH 2 alarm input , NAMUR/mechanical contact
Alarm Input	
Connection	only passive load
Rated voltage	max. 35 V
Cable length	max. 30 m
Line fault detection	lead breakage , short-circuit
NAMUR	
Sensor type	NAMUR sensor according to DIN EN 60947-6
Connection	only passive load
Rated voltage	max. 35 V
Switching frequency	10 Hz
Cable length	max. 30 m
Line fault detection	lead breakage , short circuit
Input VII, VIII	
Input type	selectable: Pt100 4-wire temperature input , NAMUR/mechanical contact
Temperature	
Connection	only passive load
Rated voltage	max. 35 V
Measurement range	-50 ... 90 °C (-58 ... 194 °F)
Accuracy	1 K
Measuring current	1 mA
Lead resistance	4.2 Ω per lead
Cable length	max. 30 m
Line fault detection	lead breakage , short-circuit
NAMUR	as input III, IV
Humidity	
Measurement range	0 ... 95 % RH
Accuracy	2 % RH
Resolution	0.04 %
Outputs	

2020-11

Output I	relay , NO contact
Output type	selectable: diagnostic bus CH 1 , relay , NO contact
Contact loading	250 V AC/ 6 A resistive load
Mechanical life	1 x 10 ⁵ switching cycles
Response time	turn-on time 7 ms , turn-off time 3 ms
Switching frequency	6 min ⁻¹ full load, 1200 min ⁻¹ without load
Output II	
Output type	selectable: diagnostic bus CH 2 , relay , NO contact
Contact loading	250 V AC/ 6 A resistive load
Mechanical life	1 x 10 ⁵ switching cycles
Response time	turn-on time 7 ms , turn-off time 3 ms
Switching frequency	6 min ⁻¹ full load, 1200 min ⁻¹ without load
Output III	
Output type	selectable: common alarm , volt-free contact , NC contact
Connection	only for the connection to protected circuits
Voltage	50 V DC
Current	max. 1 A
Output IV	
Output type	common alarm , buzzer
Electrical isolation	
All circuits/FE	functional insulation acc. to IEC 62103, rated insulation voltage 50 V _{eff}
Output I, II/other circuits	functional insulation acc. to IEC 62103, rated insulation voltage 250 V _{eff}
Ethernet/Supply	functional insulation acc. to IEC 62103, rated insulation voltage 50 V _{eff}
Ethernet/other circuits	functional insulation acc. to IEC 62103, rated insulation voltage 50 V _{eff}
Fieldbus/other circuits	functional insulation acc. to IEC 62103, rated insulation voltage 50 V _{eff}
Diagnostic Bus/other circuits	functional insulation acc. to IEC 62103, rated insulation voltage 50 V _{eff}
Directive conformity	
Electromagnetic compatibility	
Directive 2004/108/EC	EN 61326-1:2013
Low voltage	
Directive 73/23/EEC	EN 61010
Standard conformity	
Electrical isolation	IEC 62103
Electromagnetic compatibility	NE 21
Degree of protection	IEC 60529
Fieldbus standard	IEC 61158-2

Climatic conditions	DIN IEC 721
Shock resistance	EN 60068-2-27
Vibration resistance	EN 60068-2-6
Ethernet	IEEE 802.3
Ambient conditions	
Ambient temperature	-40 ... 60 °C (-40 ... 140 °F)
Storage temperature	-40 ... 85 °C (-40 ... 185 °F)
Relative humidity	< 95 % non-condensing
Shock resistance	5 g 11 ms
Vibration resistance	1 g , 10 ... 150 Hz
Protection against electrical shock	overvoltage category II
Pollution Degree	max. 2, according to IEC 60664
Corrosion resistance	acc. to ISA-S71.04-1985, severity level G3
Mechanical specifications	
Housing material	Polycarbonate
Housing width	see dimensions
Housing height	see dimensions
Housing depth	see dimensions
Degree of protection	IP20
Mass	500 g
Mounting	DIN rail mounting
Data for application in connection with Ex-areas	
FOUNDATION Fieldbus	
Connection	For connection to circuits with safe limited voltage according to IEC 60079-11:2011, type of protection ic
Voltage U_i	max. 35 V
Statement of conformity	TÜV 14 ATEX 115980 X
Group, category, type of protection, temperature class	Motherboard  II 3 G Ex nA nC IIC T4 Gc , Gateway  II 3 G Ex nA IIC T4 Gc
Directive conformity	
Directive 94/9/EC	EN 60079-0:2012 , EN 60079-11:2012 , EN 60079-15:2010
International approvals	
IECEx approval	IECEx TUN 14.0003X
Approved for	Motherboard Ex nA nC IIC T4 Gc , Gateway Ex nA IIC T4 Gc
General information	
Supplementary information	Statement of Conformity, Declaration of Conformity, Attestation of Conformity and instructions have to be observed where applicable. For information see www.pepperl-fuchs.com .

4 Hardware Installation

4.1 Power Hub and Advanced Diagnostic Module

In order to provide advanced diagnostics for FieldConnex[®] Power Hubs installation ADMs are mounted on the Power Hubs and are connected to each other and to the diagnostic gateway (DGW) via a dedicated diagnostic bus. The figure below shows an installation example.

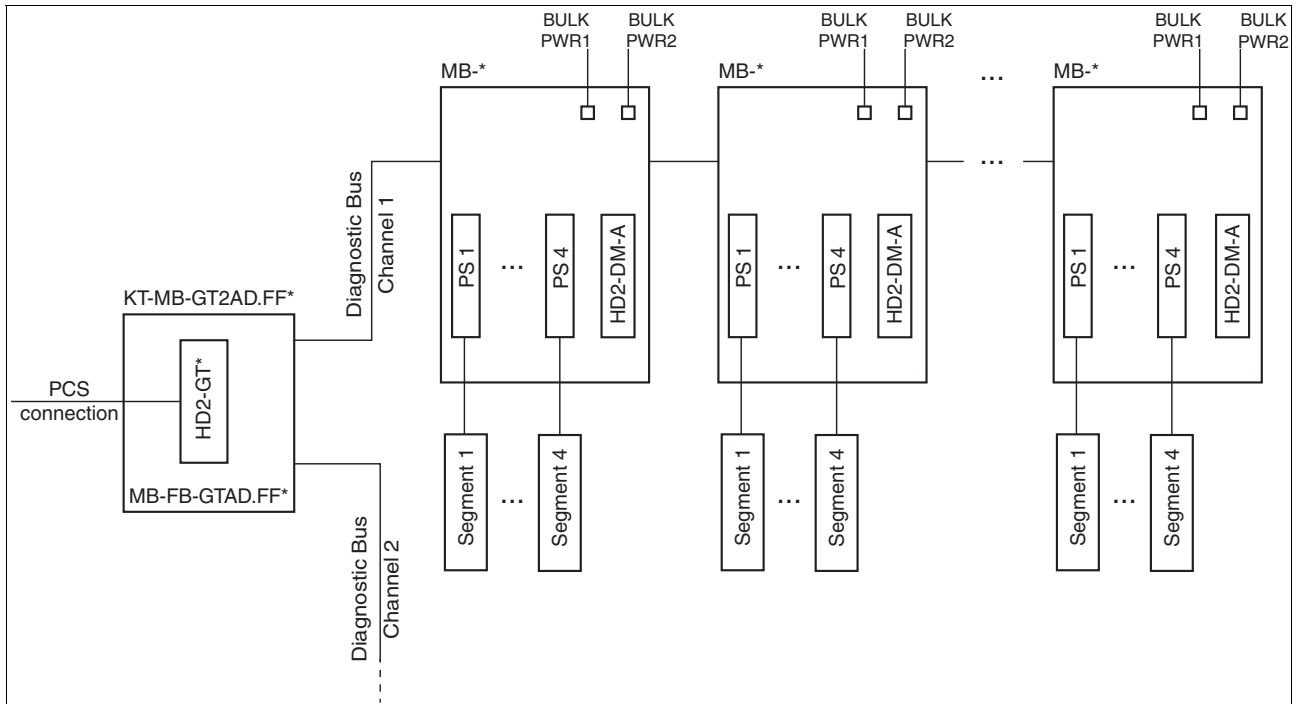

Figure 4.1 System topology with diagnostic gateway, Power Hubs and advanced diagnostic modules

The DGW provides 2 diagnostic bus channels. Depending on the PCS connection used you can connect either of the following:

- **FDS/OPC**: 31 Power Hub motherboards (for each channel) / 62 Power Hub motherboards (for both channels)
- **FOUNDATION Fieldbus**: 8 Power Hub motherboards (for each channel) / 16 Power Hub motherboards (for both channels)



Note

For best performance, use the same number of Power Hub motherboards on each diagnostic bus channel.

For the FDS/OPC integration, up to 125 DGWs or 1 000 ADMs (whichever maximum is reached first) are supported for a single FDS server installation. For the FOUNDATION Fieldbus integration, this limit does not apply because every DGW is a single FF-H1 field device without any connection to the other gateways.

Required Hardware Components

Hardware component	Description
KT-MB-GT2AD.FF or KT-MB-GT2AD.FF.IO	Kit comprising the following hardware components: <ul style="list-style-type: none"> • HD2-GT-2AD.FF.IO: Diagnostic gateway • MB-FB-GT.AD.FF / MB-FB-GT.AD.FF.IO: Motherboard for diagnostic gateway / I/O motherboard for diagnostic gateway
MB*	Depending on the number of segments and the redundancy concept, several motherboards are available. For more information see www.pepperl-fuchs.com .
HD2-DM-A	Advanced diagnostic module

4.1.1 Installing the Diagnostic Bus

The max. length of the diagnostic bus channel is 30 m.

**Installing the Diagnostic Bus**

1. To connect the diagnostic gateway to the FieldConnex[®] Power Hub, use a 4-line wire.
2. To connect the Power Hubs to each other, use a 4-wire cable or the optional ACC-MB-HDC link cable.
3. Use shielded wires for the diagnostic bus in EMC-sensitive areas. Connect the cable shield to the grounding terminal of the gateway motherboard.
4. The principal way of connecting the FieldConnex[®] Power Hubs to each other and to the Diagnostic Gateway is shown in the figure below. The actual installation depends on the used FieldConnex[®] Power Hub. Details are shown in the manual of the used FieldConnex[®] Power Hub.
5. The terminals used at the Diagnostic Gateway depend on the used Kit.
KT-MB-GT2AD.FF: see chapter 3.3.1
KT-MB-GT2AD.FF.IO: see chapter 3.4.1

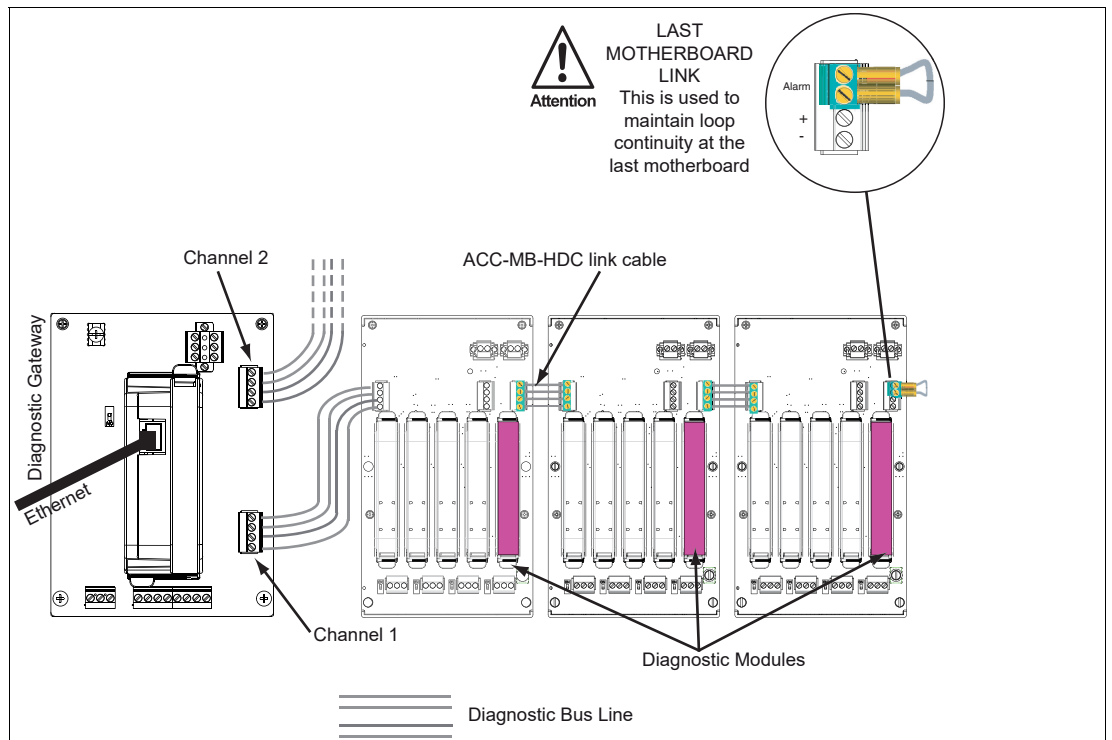

Figure 4.2 Cabinet installation example with Diagnostic Gateway



Note

Every HD2-DM-A module that is connected to the same KT-MB-GT2AD.FF* must have a unique device address. See chapter 4.1.2

4.1.2 Device Address Assignment

Before mounting the module on the motherboard, a device address must be assigned to the HD2-DM-A module. The address depends on your PCS infrastructure, see chapter 5 or see chapter 6. This assignment is performed using the DIP switch on the device. The DIP switch has 8 switches positioned next to each other. They can be used to assign addresses from 1 ... 247 in binary form.



Assigning the Device Address

In order to assign an address to the HD2-DM-A, proceed as follows:

Set each of the 8 DIP switches at the left side of the module in the correct position to generate a unique address.

For more information on how to generate a binary address, see the label on the module.

↳ The device address is assigned.

4.1.3 Connecting the PCS Connection

Depending on the used integration method, the following connections are required:

- FDS/OPC integration

An Ethernet RJ45 connector is located on the top of the diagnostic gateway. See chapter 3.3, see chapter 3.4.

- FF/H1 integration

FF-H1 connection is provided on the diagnostic gateway motherboard. See chapter 3.3, see chapter 3.4. For some features, an additional Ethernet connection can be necessary, see chapter 6.2.

**Note**

The diagnostic gateway FF-H1 connection must never be connected to device couplers like the Pepperl+Fuchs Segment Protectors or FieldBarriers.

The diagnostic gateway must be connected directly to the trunk.

For best performance, we recommend using a separate FF-H1 diagnostic segment for diagnostic gateways. Scheduled FB data must be kept to a minimum for this segment.

4.2 Kit for Stand-Alone Operation and Advanced Diagnostic Module

The KT-MB-DM kit for stand-alone operation enables the installation of the FieldConnex[®] advanced physical layer diagnostics for non-FieldConnex–Power–Hub-based installations. The advanced diagnostic module HD2-DM-A is installed on a motherboard enabling the connection to 4 FOUNDATION Fieldbus H1 or PROFIBUS PA segments. The motherboards are connected to each other and to the diagnostic gateway (DGW) using a dedicated diagnostic bus. The figure below shows an installation example.

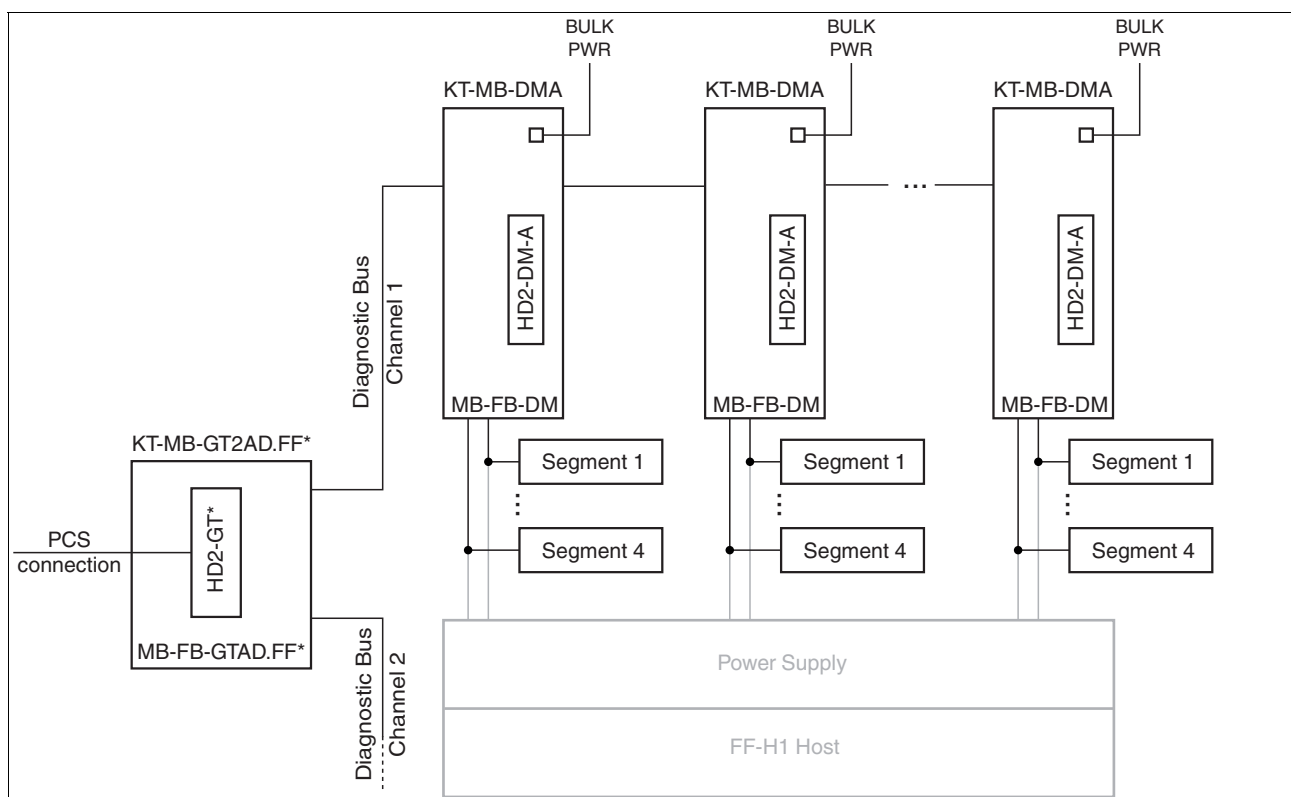

Figure 4.3 System topology with diagnostic gateway and kits for stand-alone operation

The DGW provides 2 diagnostic bus channels. Depending on the selected integration solution used, you can connect either of the following:

- **FDS/OPC Integration:** 62 stand-alone kits (for both channels) / 31 stand-alone kits (for each channel)
- **FOUNDATION Fieldbus:** 16 stand-alone kits (both channels) / 8 stand-alone kits (for each channel)

**Note**

For best performance, use the same number of Power Hub motherboards on each diagnostic bus channel.

For the FDS/OPC integration, up to 125 DGW or 1 000 ADMs (whichever maximum is reached first) are supported for a single FDS server installation. For the FOUNDATION Fieldbus integration, this limit does not apply because every DGW is a single FF-H1 field device without any connection to the other gateways.

Required Hardware Components

Hardware Component	Description
KT-MB-GT2AD.FF or KT-MB-GT2AD.FF.IO	Kit comprising the following hardware components: <ul style="list-style-type: none"> • HD2-GT-2AD.FF.IO: Diagnostic gateway • MB-FB-GT.AD.FF / MB-FB-GT.AD.FF.IO: Motherboard for diagnostic gateway / I/O motherboard for diagnostic gateway
KT-MB-DMA	Kit comprising the following hardware components: <ul style="list-style-type: none"> • HD2-DM-A: Advanced diagnostic module • MB-FB-DM: Stand-alone motherboard for advanced diagnostic module

4.2.1 Installing the Diagnostic Bus

The maximum length of the diagnostic bus channel is 30 m.



Installing the Diagnostic Bus

1. In order to connect the diagnostic gateway to the FieldConnex® Power Hub, use a 4-line wire.
2. In order to connect the Power Hubs with each other, use a 4-wire cable or the optional ACC-MB-HDC link cable.
3. Use shielded wires for the diagnostic bus in EMC-sensitive areas. Connect the cable shield to the grounding terminal of the gateway motherboard.
4. The principal way of connecting stand-alone kits to each other and to the diagnostic gateway is shown in the figure below.
5. The terminals used at the diagnostic gateway depends on the kit used.
 KT-MB-GT2AD.FF: see chapter 3.3.1
 KT-MB-GT2AD.FF.IO: see chapter 3.4.1

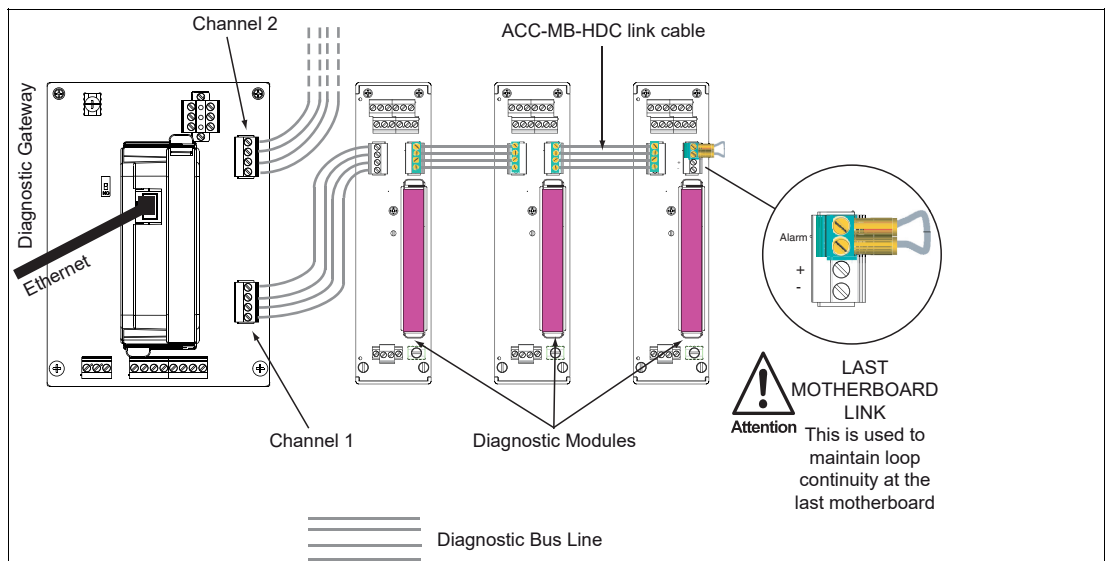

**Note**

Every HD2-DM-A module that is connected to the same KT-MB-GT2AD.FF* must have a unique device address. See chapter 4.1.2

4.2.2 Connecting Stand-Alone Kits to Segments



Connecting the Stand-Alone Diagnostic Motherboard to the Segment

The stand-alone diagnostic motherboard supports connection of up to 4 segments. In order to connect a stand-alone diagnostic motherboard to a segment, proceed as follows:

Wire the segment connections of the stand-alone diagnostic motherboard in parallel to the segment output lines (trunks) of your fieldbus power supplies.



Connecting the Stand-Alone Diagnostic Motherboard to the Bulk Power Supply

Connect the stand-alone diagnostic motherboard in parallel to the bulk power supply of the fieldbus power supplies.

↳ The stand-alone diagnostic motherboard is now supplied with power. The bulk power supply of the fieldbus power supplies is also monitored.

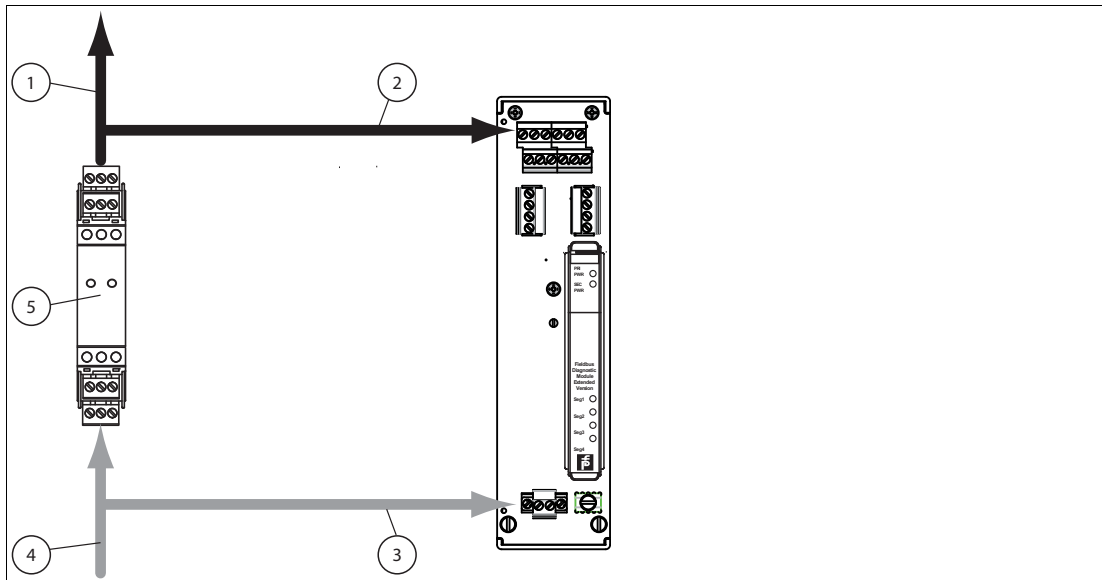

Figure 4.4 Trunk connection

- 1 Trunk line to segment
- 2 Trunk line to segment connection (parallel circuit)
- 3 Connection KT-MB-DMA bulk power supply
- 4 Connection fieldbus bulk power supply
- 5 Fieldbus power supply

4.2.3 Device Address Assignment

Before mounting the module on the motherboard, a device address must be assigned to the HD2-DM-A module. The address depends on your PCS infrastructure, see chapter 5 or see chapter 6. This assignment is performed using the DIP switch on the device. The DIP switch has 8 switches positioned next to each other. They can be used to assign addresses from 1 ... 247 in binary form.



Assigning the Device Address

In order to assign an address to the HD2-DM-A, proceed as follows:

Set each of the 8 DIP switches at the left side of the module in the correct position to generate a unique address.

For more information on how to generate a binary address, see the label on the module.

↳ The device address is assigned.

4.2.4 Connecting the PCS Connection

Depending on the used integration method, the following connections are required:

- FDS/OPC integration

An Ethernet RJ45 connector is located on the top of the diagnostic gateway. See chapter 3.3, see chapter 3.4.

- FF/H1 integration

FF-H1 connection is provided on the diagnostic gateway motherboard. See chapter 3.3, see chapter 3.4. For some features, an additional Ethernet connection can be necessary, see chapter 6.2.



Note

The diagnostic gateway FF-H1 connection must never be connected to device couplers like the Pepperl+Fuchs Segment Protectors or FieldBarriers.

The diagnostic gateway must be connected directly to the trunk.

For best performance, we recommend using a separate FF-H1 diagnostic segment for diagnostic gateways. Scheduled FB data must be kept to a minimum for this segment.

4.3 Shielding and Grounding



Caution!

Risk of electric shock or property damage from inadequate grounding

If you fail to connect all metal parts of the device to protective local earth correctly, this could result in potential equalization currents. These electric currents could hurt operating personnel or cause property damage.

The grounding terminal is not a protective earth: Do not use the grounding terminal to ground exposed metal parts.

Do ground exposed metal parts of the device separately. Ensure that a correct grounding is guaranteed at all times.

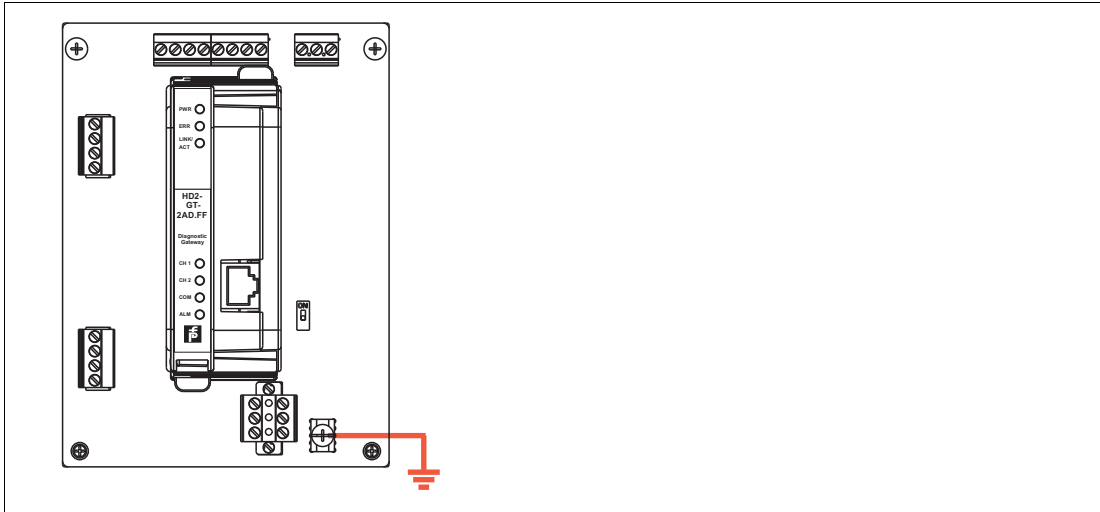

Figure 4.5 KT-MB-GT2AD.FF grounding terminal

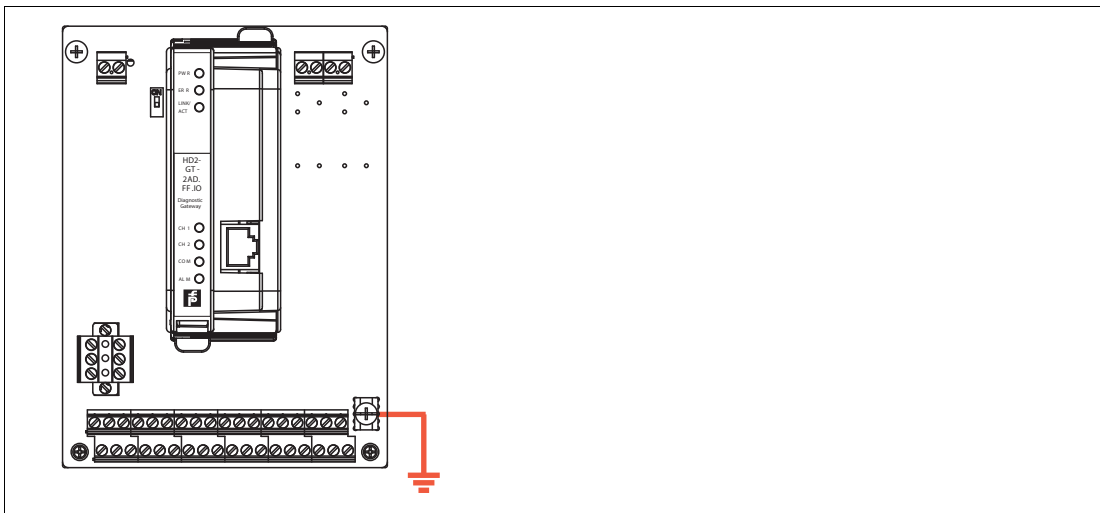
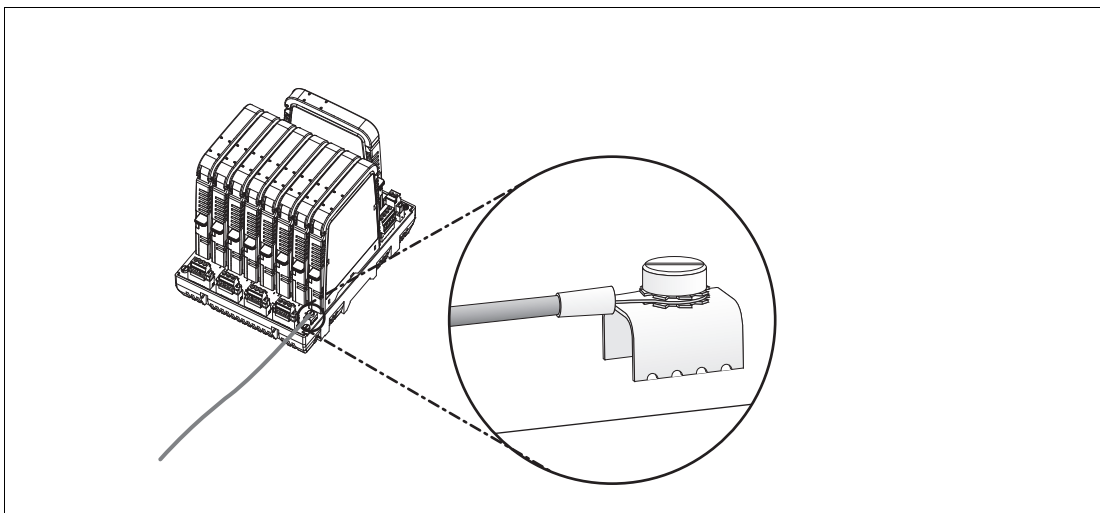

Figure 4.6 KT-MB-GT2AD.FF.IO grounding terminal



All shield connections are internally connected to the "Shield/Screen GND" grounding terminal.

Connecting the Ground Connection Cable



**Note**

Use a cable with a minimum cross section of 4 mm².

1. Connect the ground cable to a cable lug.
2. Position the cable lug over the grounding terminal with the cable pointing downwards.
3. Screw the cable lug to the grounding terminal with 2 detent-edge washers inserted between screw, lug, and terminal as illustrated:

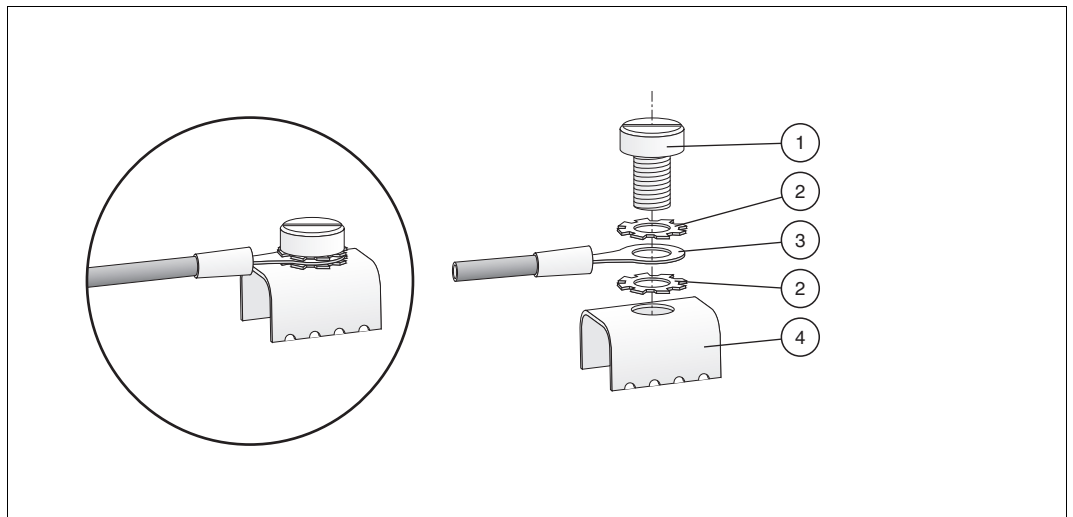

Figure 4.7 Connecting the ground connection cable

- 1 Screw
- 2 Toothed lock washer
- 3 Cable lug
- 4 Grounding terminal on motherboard

4. Tighten the screw with a torque of 1.5 Nm.
↳ The cable lug is properly attached and cannot come loose.

Connect the "Shield/Screen GND" grounding terminal of the motherboard to an equipotential bonding system.

4.4 Volt-Free Contact Installation

The FDS/OPC integration and the FOUNDATION Fieldbus integration provide the functionality to configure the advanced diagnostic modules, to analyze the measured fieldbus physical layer data and to send alarms to a PCS. For the alarm integration, a volt-free contact can also be used for both integration methods.

The alarm contacts are NC contacts. The alarm contacts are closed, if no alarm is active and the contacts are opened if an alarm is active.

The volt-free contact alarming is built into the ADM HD2-DM-A and also supported by the diagnostic gateway. The installation depends on the diagnostic gateway and the integration method used.

4.4.1 KT-MB-GT2AD.FF

FDS/OPC Integration

Each diagnostic bus carries its own volt-free contact lines. These lines are connected on the motherboard to the following terminals:

- Channel 1: Alarm output for diagnostic bus channel 1
- Channel 2: Alarm output for diagnostic bus channel 2

The common alarm output terminals are not used. The 2 diagnostic bus channels can be connected separately to PCS inputs or can be wired in series.

FOUNDATION Fieldbus Integration

If the FOUNDATION Fieldbus integration is used the volt-free contacts can be used the same way as for the FDS/OPC integration. Beside this, the common alarm output can be configured to react to the FOUNDATION Fieldbus field diagnostic parameters. For more information, see chapter 7. Since the DGW-FF reads the alarm status of all connected ADMs using the 8 communication lines of the diagnostic bus and sets the FF field diagnostic according to the status of the ADMs, the common alarm output can reflect the alarm status of the connected ADMs.

4.4.2 KT-MB-GT2AD.FF.IO

FDS/OPC Integration

The diagnostic gateway functionality allows configuring the outputs of the I/O motherboard according to the status of the field diagnostic parameters. This status can also be influenced by the binary inputs of the diagnostic bus alarm contacts.

Typically, binary input 5 and binary input 6 are configured to create a field diagnostic alarm and the common alarm output to be activated if any field diagnostic alarm becomes active.

FOUNDATION Fieldbus Integration

If the FOUNDATION Fieldbus integration is used, the volt-free contacts can be used the same way as for the FDS/OPC integration. Since the DGW-FF reads the alarm status of all connected ADMs using the communication lines of the diagnostic bus and sets the FOUNDATION Fieldbus field diagnostic according to the status of the ADMs, it is not required to read the ADM status based on binary inputs. In this case, the binary input 5 and binary input 6 are not required to be connected to the I/O motherboard and can be used independently for other I/O purposes.

Note

The volt-free contact lines of the diagnostic bus of the ADM modules can be connected directly to a PCS input. The lines are not required to be connected to the motherboard of the diagnostic gateway. If this is applicable for an installation, binary input 5 and binary input 6 can be used independently for other I/O purposes.



5 FDS/OPC Integration

The FDS/OPC integration uses the open standards OPC and FDT in order to integrate the FieldConnex[®] advanced diagnostics into the PCS. It is based on a server component called FieldConnex[®] diagnostic server (FDS). The FDS has the 2 following main tasks:

- The FDS includes an OPC server for OPC DA and AE. Alarms caused by physical layer issues are available to the PCS through this interface.
- The FDS provides access to the diagnostic gateways and ADMs for the diagnostic manager. The diagnostic manager is the advanced diagnostics user interface and includes special user interfaces for commissioning, monitoring and troubleshooting.

The figure below shows the basic concept of this integration:

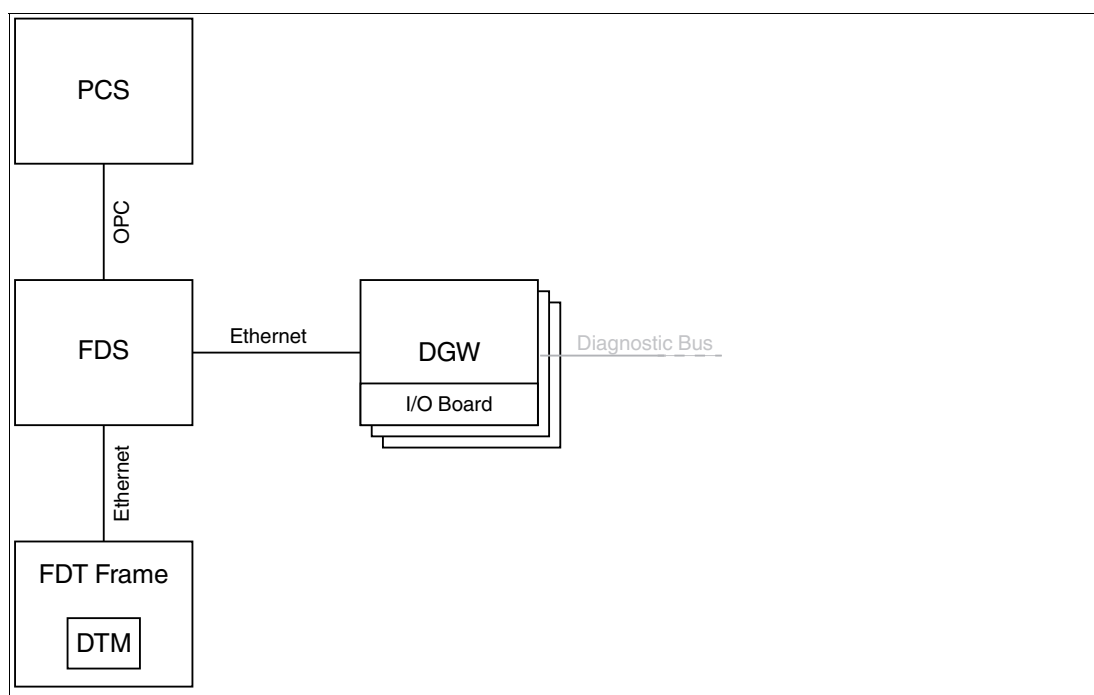

For many process control systems, so-called advanced diagnostic module (ADM) integration packages exist. These packages provide step-by-step guides and additional software tools to seamlessly integrate advanced diagnostics in a PCS. ADM projects including segment and field device tags are built directly from the PCS database. The alarm function and the diagnostic manager are tightly integrated in the PCS asset management. Manual OPC configuration etc. is not required. Check www.pepperl-fuchs.com for available ADM integration packages.

The diagnostic manager can be deployed in either of the following 2 ways:

- For smaller fieldbus installations, it is recommended to use the **local application structure**. The diagnostic manager and FDS are installed on the same PC.
- For large fieldbus installations where real-time monitoring takes place from multiple computers throughout the plant, it is recommended to use the **remote application structure**. The diagnostic manager and FDS are installed on different computers and communicate with each other using TCP/IP.

Required software:

- FDT frame, e. g., PACTware[™] or ADM integration package
- FieldConnex[®] diagnostic manager (DTMs and FDS)
- Appropriate software license:
 - DTM-FC.AD for < 100 segments
 - DTM-FC.AD.1 > 100 segments

5.1 Installation of Diagnostic Manager with PACTware™



Installing the Diagnostic Manager with PACTware™

Make sure you downloaded the software bundle that includes the diagnostic manager and all its tools and accessories, including PACTware™, the FieldConnex® diagnostic server, and the diagnostic gateway configuration tool from www.pepperl-fuchs.com. To install the diagnostic manager, proceed as follows:

1. Extract the software bundle to a local directory.
2. Go to the directory that includes the extracted files and run **autorun.exe** to start the installation wizard.
3. Select the software components you want to install and choose **Install selected application(s)**. We recommend that you install all components.
4. In order to install the Microsoft® .NET framework, follow the instructions of the installation dialog.
5. In order to install PACTware™, follow the instructions of the installation dialog.
6. In order to install the diagnostic manager, follow the instructions of the installation dialog. Note that during the installation of the diagnostic manager, the diagnostic server and the OPC server are installed automatically.
7. After the selected components have been installed, choose **Quit** to leave the installation wizard.

↳ The diagnostic manager and PACTware™ have now been installed.

8. Run **PACTware™**.
9. Choose **View > Device catalog**.
10. Choose **Update device catalog** in the device catalog section.



Figure 5.1 Update device catalog

11. Choose **Yes** to create a new PACTware™ device catalog.
12. Choose **Extras > Options**.
13. Set the **Use memory-optimized project management** check box.
14. Choose **OK**.
15. Choose **File > Exit** to quit PACTware™.

↳ PACTware™ is ready for use.



Caution!

Network Connection Problems

The diagnostic server cannot connect to the network.

After the setup is complete, disable the Windows® firewall for the diagnostic server.

5.2 Licensing

To activate the full-featured version, you need a license key. The license key is printed on the license certificate you have optionally received with the FieldConnex[®] diagnostic manager software package. If you have downloaded the diagnostic manager from the internet, a license key can be ordered through your local Pepperl+Fuchs representative.



Note

Upgrade Information

After upgrading from diagnostic manager version 1.x to version 2.x activate the new version with the upgrade license key. After the complete reinstallation of the diagnostic manager (e.g., installation on a new PC), enter both license keys from version 1.x and 2.x one after the other into the license activation tool.



Activating the License

Before entering the license key, make sure that the diagnostic manager is closed.

1. Choose **Start > Programs > Pepperl+Fuchs > Activation Tool** to start the Pepperl+Fuchs license activation tool.

↳ The license activation tool dialog appears.

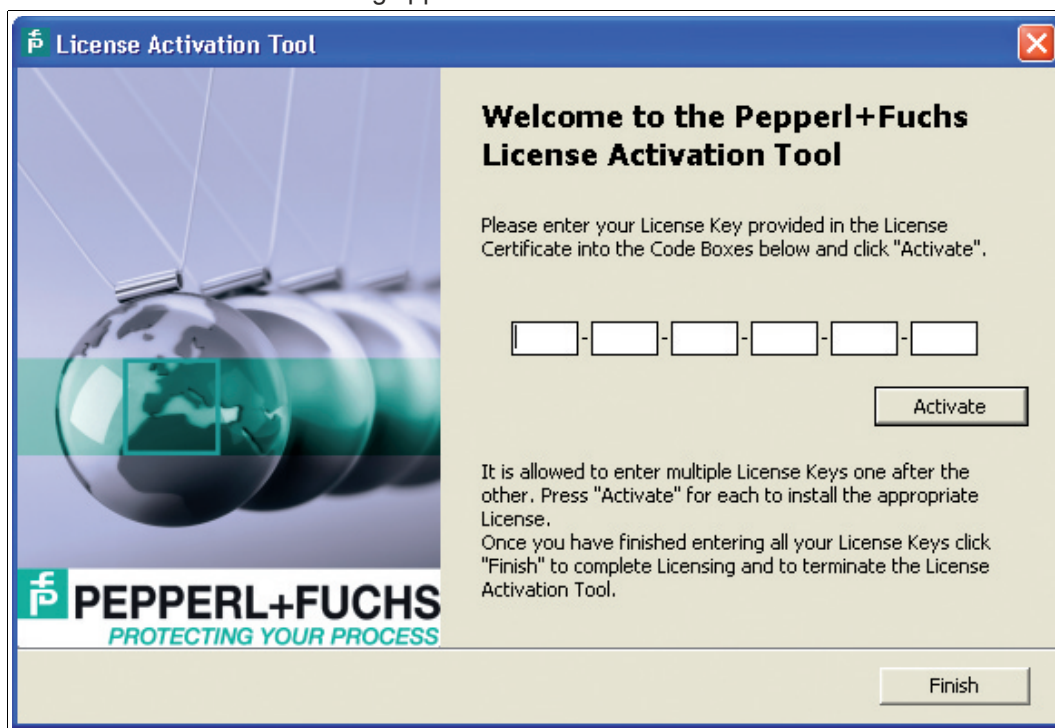

Figure 5.2 License activation tool

2. Enter your license key.
3. Choose **Activate**.
4. After the activation has been confirmed, choose **Finish**.



5.3 FDS Control Center

The FieldConnex[®] diagnostic server (FDS) is part of the FieldConnex diagnostic manager setup and can be installed together with the DTMs for the local application structure as well as alone for the remote application structure. Beside providing access to the diagnostic hardware for the diagnostic manager DTMs it includes an OPC DA & AE server. This OPC server provides the alarm information of the advanced diagnostic system to a PCS. The FDS itself is built of 2 components:

- The **FDS service** is a Windows[®] service providing the FDS and OPC functionality.
- The **FDS control center** is a Windows[®] program for the configuration of the FDS service.

This chapter describes the configuration of the FDS using the FDS control center. For more information on data available at the OPC interface, see chapter 8.12

The FDS control center can be minimized to the Windows[®] notification section, where the current status of the FDS is shown:

Icon	Description
	Green status icon: FDS is running
	Red status icon: FDS is not running

5.3.1 FDS Configuration

Step-by-Step FDS Configuration

By default, the FDS control center starts with Windows[®]. If the FDS control center does not start automatically, proceed as follows:

1. Choose **Start > Programs > Pepperl+Fuchs > FDS Control Center**.
↳ The FDS control center appears.
2. Choose **Settings**.
3. Set the **Start control center automatically** check box to make sure that the FDS control center starts automatically with Windows[®].
4. If the remote application structure is used, activate the **Adjust firewall to allow remote access** check box, to disable the Windows[®] firewall for the FieldConnex diagnostic server.
5. You can change the SOAP communication port number. The default port is 25 061.
6. Choose **OK**.
7. Some settings take effect only after the FDS is restarted. Choose **Stop FDS** from the control center toolbar.

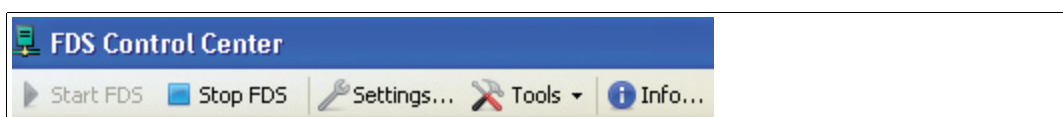

Figure 5.3 FDS Control Center toolbar

↳ The FDS status icon in the taskbar turns red.

8. After the server has stopped, choose **Start FDS** to restart the server with the updated settings.
↳ The FDS status icon in the taskbar turns green and the FDS is running with the updated settings.
9. Choose **Hide** to minimize the FDS control center into the task bar.



Caution!**Network Connection Problems**

The diagnostic server is not connected to the network.

Ensure that the **Adjust firewall to allow remote access** check box is set to "Disable Windows[®] firewall" for the diagnostic server.

5.3.2

FDS Configuration Options



Changing FDS Settings

In order to change the FDS startup behavior, proceed as follows:

1. Right-click on the FDS icon in the task bar.
2. Choose **FDS Control Center**.
↳ The **FDS Control Center** window appears.
3. Click the **Stop FDS** button.
4. Click **Settings ...**
5. Change the settings. For further information see table below.
6. Click **OK**.
7. Restart FDS.

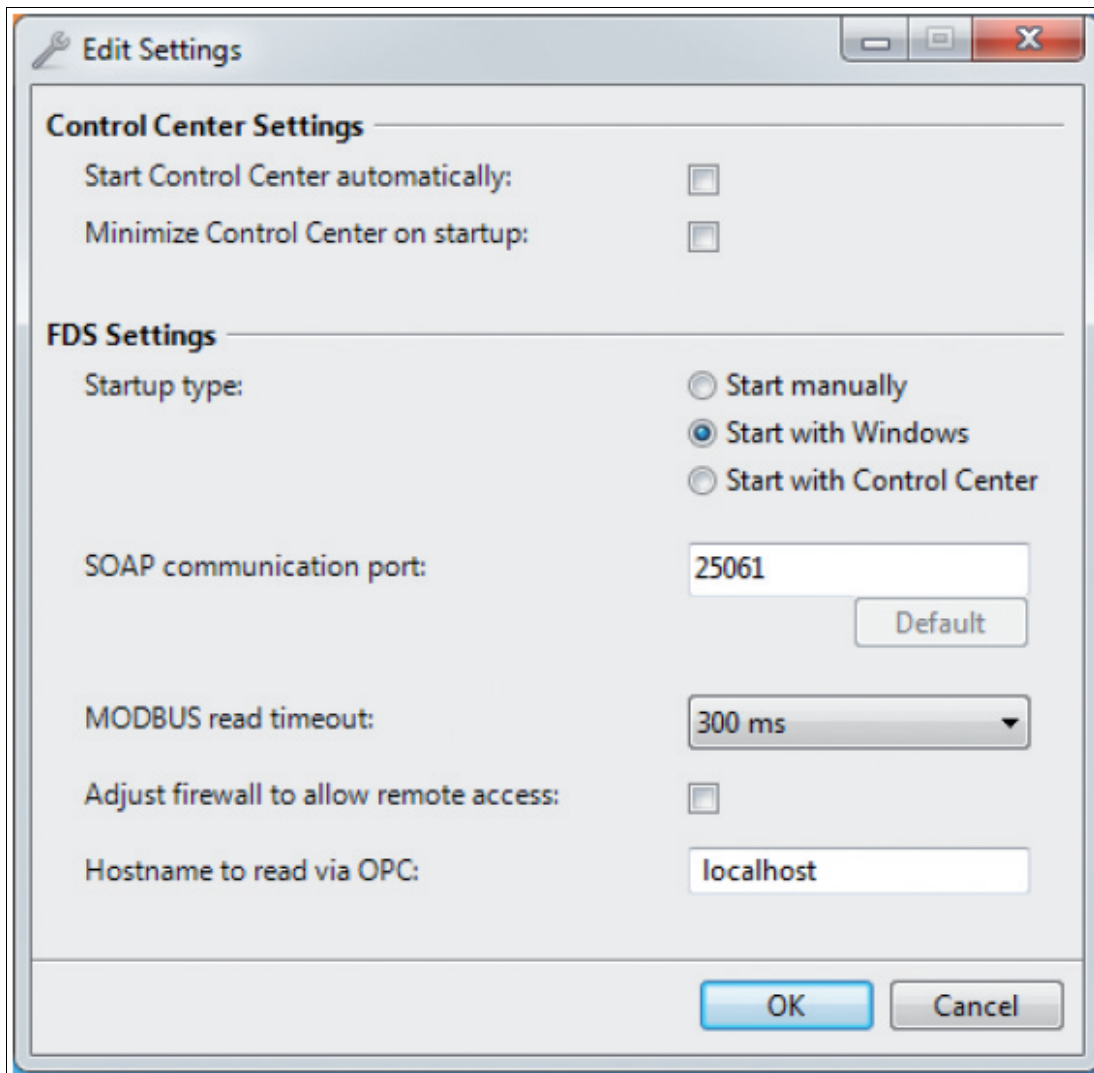

The following settings can be made:

Control center settings	Description
Start the control center automatically	Every time the PC starts, the control center server starts, too.
Minimize the control center on startup	The control center starts without the frontend application. The running application is visualized by an icon in the task bar.
Startup type	<ul style="list-style-type: none"> • Start manually: The FDS control center has to be started manually every time. • Start with Windows: The FDS control center starts automatically when Windows® is running (no user login required) • Start with control center: Every time the FDS control center starts, the FDS server starts, too.
SOAP communication port	Port number for SOAP communication by default: 25 061.
MODBUS read timeout	Adjustment option for communication. Change only if a change was advised by Pepperl+Fuchs.

2020-11

Control center settings	Description
Adjust firewall to allow remote access	Edit the firewall settings for the FDS server.
Read host name via OPC	Enter the host name. The host name is used by OPC clients to find the FDS.

5.4 Project Setup

A diagnostics project can be set up in either of the following ways:

- **Manual setup:** Enables you to build the diagnostic topology before the diagnostic bus is installed or if the diagnostic bus is currently inactive. See chapter 5.4.3
- **Scanning:** Enables you to import the topology from a diagnostic bus that is already installed and active. See chapter 5.4.6
- **Import from a file:** see chapter 5.4.7. The "Import from file" option is typically used for the ADM integration package available for the major process control systems. See "Application Notes for the ADM Integration Packages" for details.
- **Import from FDS:** Reads back the project currently set at the FDS server. See chapter 5.4.8

5.4.1 Tags Used in ADM Projects

An advanced diagnostic module (ADM) system uses tags for the diagnostic gateways, the ADMs, and the segments. Note that tags may only contain the following characters: 0 ... 9, a...z, A...Z, or the following special characters: \$ () - _ . Other characters or blank spaces are not allowed. Tags of the same level must be unique, i.e., any 2 FDS ports or 2 diagnostic devices beneath the same FDS port must not be tagged identically.

5.4.2 Communication with the Diagnostic Gateway

In order to communicate with the diagnostic gateways (DGW), an IP address must be assigned to the device. The IP address can be set in either of the following ways:

- Set the IP address using **DHCP** (default setting)
- Set the IP address to a **fixed IP address**

In addition to the IP address, a tag can be assigned to each diagnostic gateway. Setting a tag allows a simple identification of the diagnostic gateway while creating a diagnostic project. The IP address setting and the tag can be modified using the diagnostic gateway configuration tool. For more information on the diagnostic gateway configuration tool, . It also supports communication to the diagnostic gateway if the web server cannot be used because of wrong IP address settings.

The next chapters introduce options to scan for available diagnostic gateways in several situations. As long as the FDS is located in the same subnet as the diagnostic gateways, the gateways are detected automatically. If the diagnostic gateways are in a different IP subnet, the address of at least one diagnostic gateway in the other subnet must be entered manually. After that, all other diagnostic gateways in the remote subnet can also be scanned.

5.4.3 Manual Setup of a Diagnostic Project with PACTware™



Manually Modeling the Diagnostic Topology

Before you start, ensure that the FieldConnex® diagnostic server (FDS) is running, the latest diagnostic manager is installed, and that the PACTware™ device catalog is up-to-date.

1. Start **PACTware™**.
2. Choose **File > New** to create a new project.
3. Choose **View > Device Catalog** to open the device catalog.

4. Open the **PEPPERL+FUCHS GmbH** device folder.

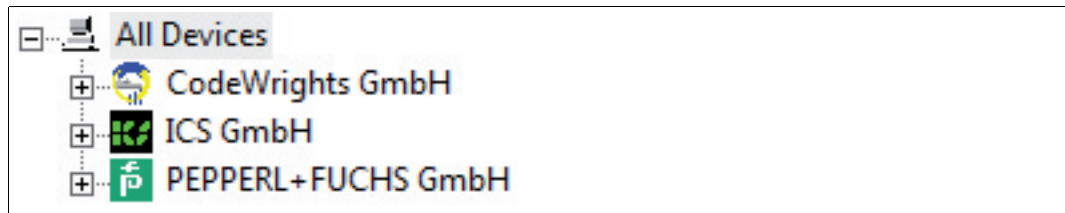

Figure 5.4 Structure in the PACTware™ device catalog

5. Select the **Driver** folder.

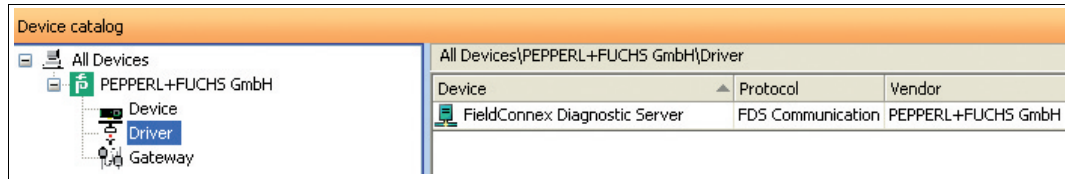

Figure 5.5 Device overview of the **Driver** folder

6. Drag the **FieldConnex®** Diagnostic Server entry from the device catalog section on the **HOST PC** entry in the project section.
7. Select the **Gateway** folder in the device catalog section.
8. Drag the **FDS Port** entry from the device catalog section on the **FieldConnex®** Diagnostic Server entry in the project section.
9. Select the **Device** folder in the device catalog.
10. Drag the **HD2-DM-A** entry from the device catalog section on the **FDS Port** entry in the project section.
11. Right-click the **FieldConnex®** Diagnostic Server in your project section and select **Parameter**.
↳ The **FDS Parameter** tab opens.

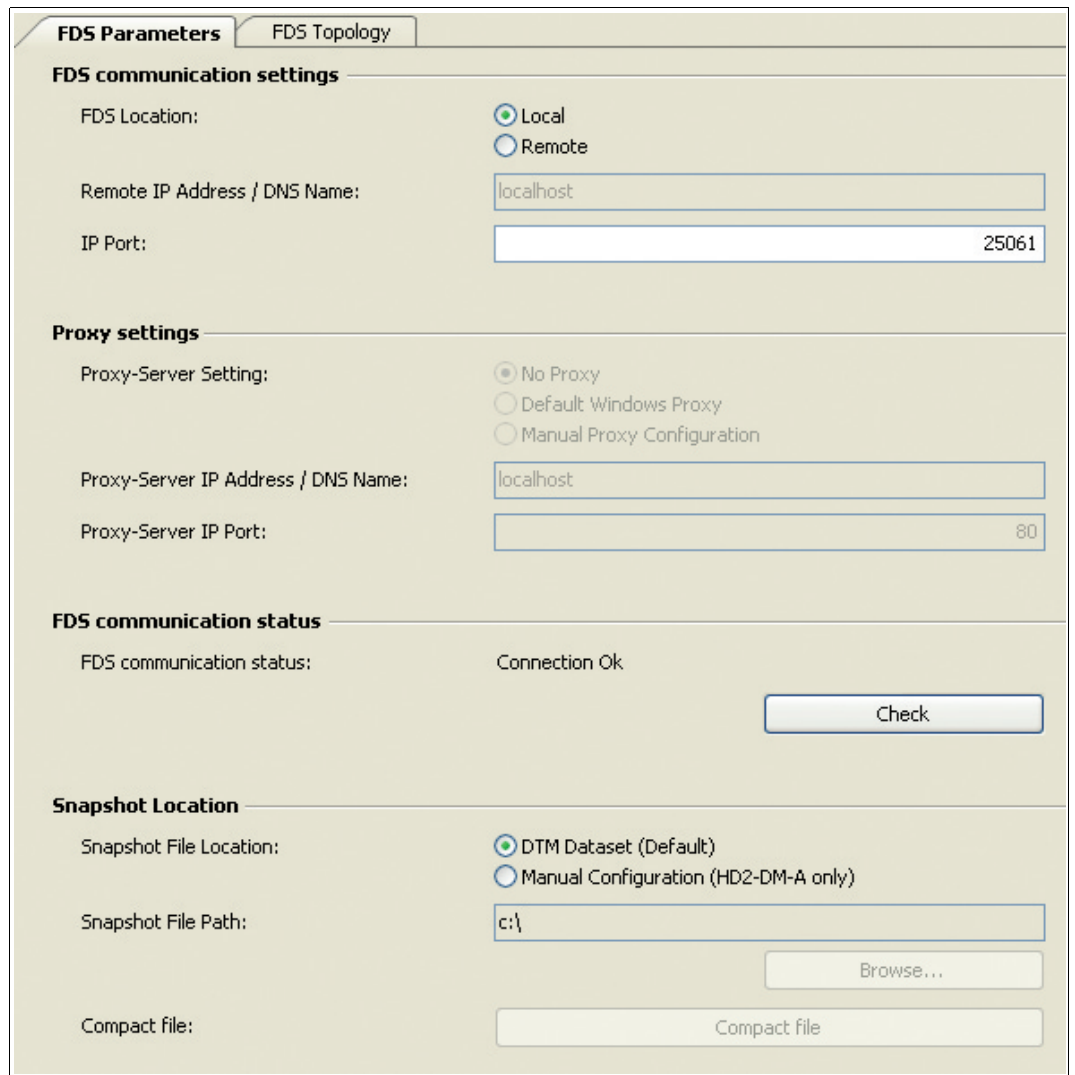

Figure 5.6 FieldConnex® Diagnostic Server (FDS) parameter tab

12. If PACTware™ and FDS are running on the same system, select **Local** for the FDS Location. If the FDS is running on a different system, for example in a remote application structure, select **Remote** for the FDS location and enter the IP address or DNS name of the remote PC. Enter the IP port of the FDS. Note that you can define the IP port for the FDS in the FDS control center. See chapter 5.3

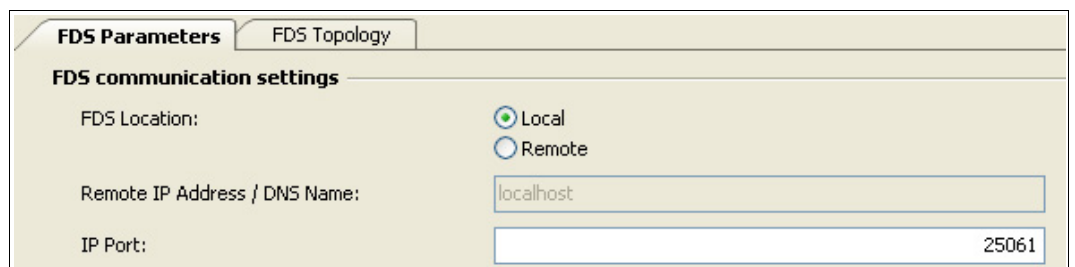

Figure 5.7 Settings when the FDS is running on the same PC

↳ Now the diagnostic project looks similar to this example:

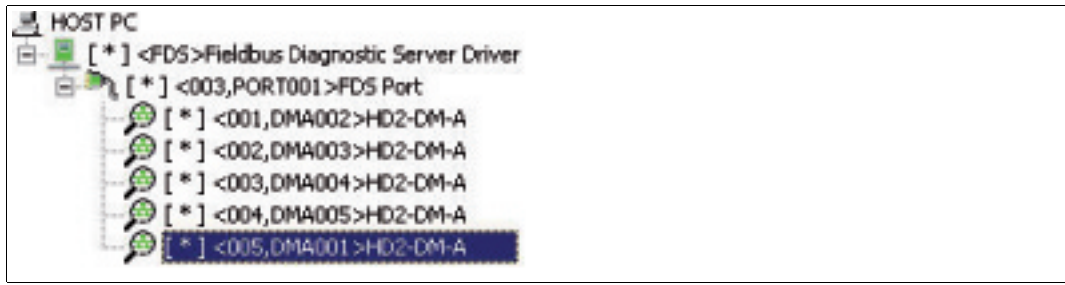

Figure 5.8 Diagnostic project

13. Choose **Apply** to confirm changed settings.



Note

For fast creation of projects with a huge number of advanced diagnostic modules (ADM): Build one FDS port with 62 diagnostic modules. if supported by the FDT software, you can use copy & paste to duplicate the new port in the project.



Note

Note that the maximum number of diagnostic modules per FDS port is 62.

5.4.4 Assign Diagnostic Gateway Addresses



Assigning Diagnostic Gateway Addresses (Option 1)

1. Right-click the **FieldConnex[®]** Diagnostic Server in the project section and choose **Parameter**.
2. Select the **FDS Topology** tab.

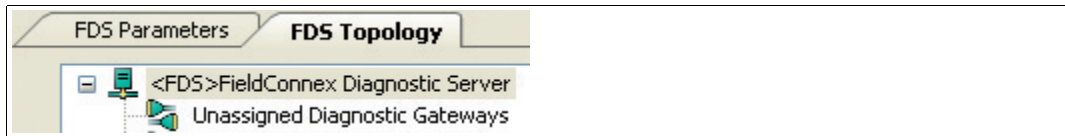

Figure 5.9 FDS Topology tab

3. Select the **???** port in the topology structure.

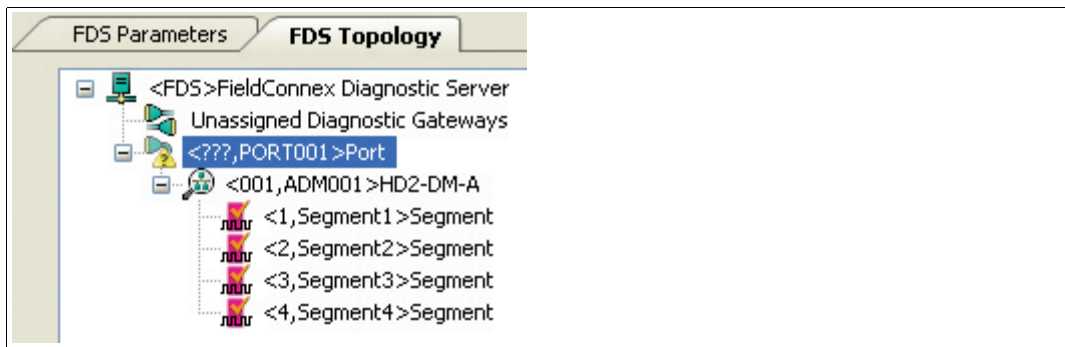

Figure 5.10 Unassigned Port

4. Enter port tag and IP address.

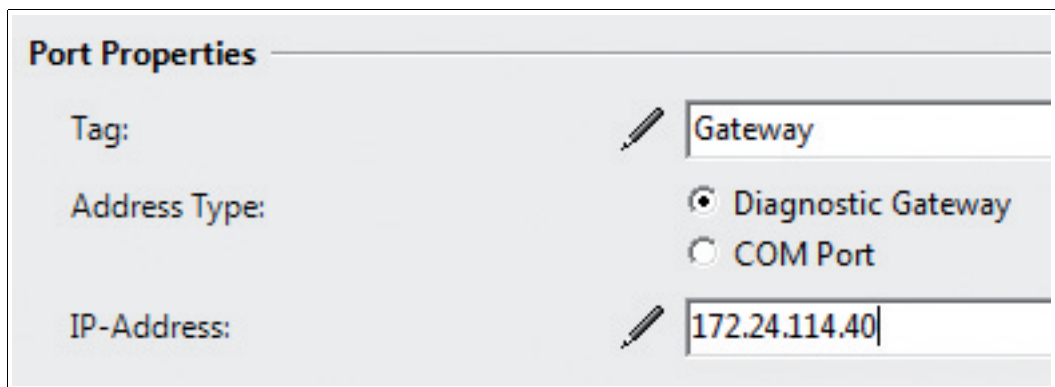

Figure 5.11 Port Properties

5. Choose **Apply** to confirm changed settings.

↳ IP address and tag of the Diagnostic Gateway are assigned to the port.



Assigning Diagnostic Gateway Addresses (Option 2)

1. Right-click the **FieldConnex®** Diagnostic Server in the project area and choose **Connect**.
2. Right-click the **FieldConnex®** Diagnostic Server in the project area and choose **Parameter**.
3. Select the **FDS Topology** tab.

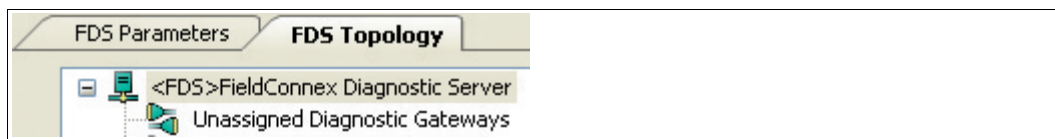

Figure 5.12 FDS Topology tab

4. Select the **Unassigned Diagnostic Gateways** entry in the topology structure.

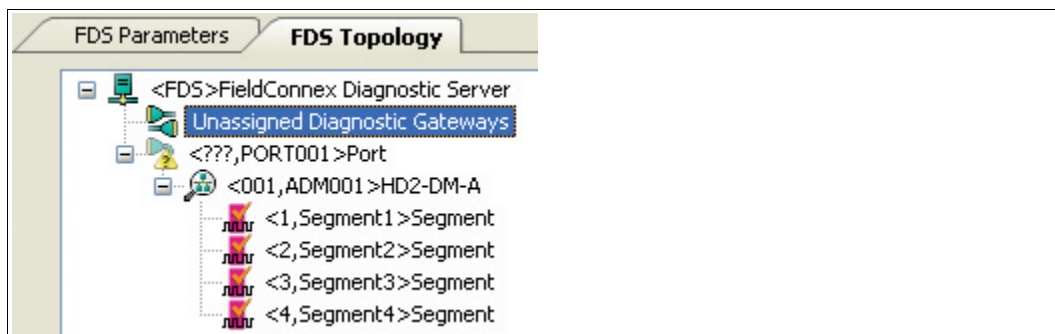

Figure 5.13 Unassigned Diagnostic Gateway

5. Choose **Update** in the **Unassigned Diagnostic Gateways** area.

↳ All Diagnostic Gateways located within the subnet are shown in the table.

IP Address	Tag of the Diagnostic Gateway	Subnet
Local Subnet		
<input checked="" type="checkbox"/> 172.24.114.40	KT-MB-GT2AD_1	Local

Figure 5.14 All Gateways

- If the Diagnostic Gateway is located in a different subnet, enter its IP address in the **Remote subnet IP address** field and choose **Add**. Then choose **Update** to find all Diagnostic Gateways in the subnet.

IP Address	Tag of the Diagnostic Gateway	Subnet
Local Subnet		
✓ 172.24.114.40	KT-MB-GT2AD_1	Local
172.24.114.129 ✖		
✓ 172.24.114.129	Jens	172.24.114.129
✓ 172.24.114.164	Martin_SA-Board	172.24.114.129

Figure 5.15 Scanned gateways

- To identify a gateway in the cabinet, select the gateway from the list and choose **Locate selected gateway(s)**.
↳ Gateways LEDs are flashing in the cabinet.
- Drag the **Diagnostic Gateway** from the Unassigned Diagnostic Gateways area on an unassigned **???** port in the topology structure.
↳ IP address and tag of the Diagnostic Gateway are automatically assigned to the port.

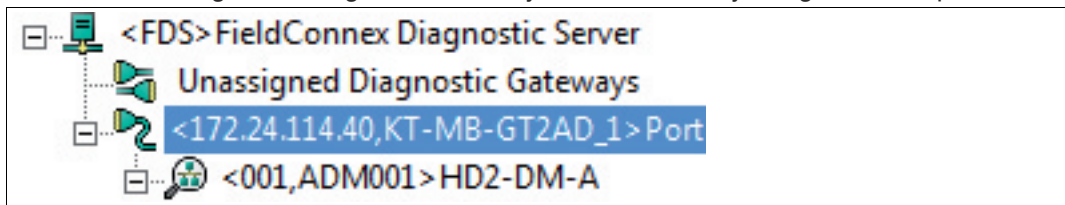

Figure 5.16 Assigned gateway

- Choose **Apply** to confirm changed settings.

5.4.5 Assign HD2-DM-A Addresses



Registering the Device Address of Diagnostic Modules

Each advanced diagnostic module (ADM) has a device address that is assigned directly on the device. See chapter 4.1.2

In order to register the device address of each ADM, proceed as follows:

- Right-click the **FieldConnex®** Diagnostic Server in the project section and choose **Parameter**.
- Select the **FDS Topology** tab.
- Select the ADM you want to configure in the topology structure.
- Select the device address for the selected ADM in the **Address of the ADM** drop-down list.

Figure 5.17 Device address settings

- Choose **Apply** to confirm changed settings.

5.4.6 Scanning of a Diagnostic Installation for Project Setup



Importing the Topology

Before you start, ensure that the FieldConnex[®] diagnostic server (FDS) is running, the latest diagnostic manager is installed, and that the PACTware[™] device catalog is up-to-date.

1. Start **PACTware[™]**.
2. Choose **File > New** to create a new project.
3. Choose **View > Device Catalog** to open the device catalog.
4. Open the **PEPPERL+FUCHS GmbH** device folder.

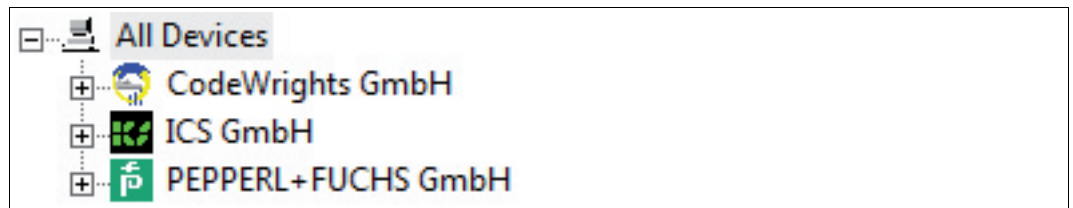

Figure 5.18 Structure in the PACTware[™] device catalog

5. Select the **Driver** folder.

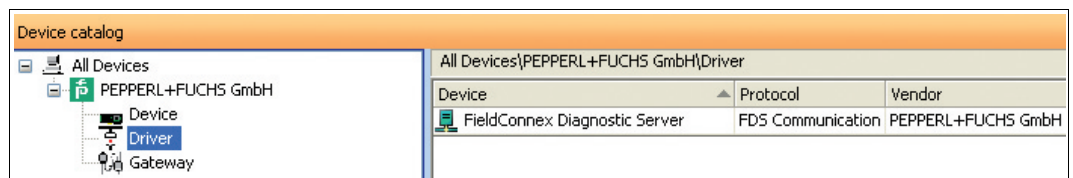

Figure 5.19 Device overview of the **Driver** folder

6. Drag the **FieldConnex[®] Diagnostic Server** entry from the device catalog section on the **HOST PC** entry in the project section.
7. Right-click the **FieldConnex[®] Diagnostic Server** in the project section and choose **Connect**.
8. Right-click the **FieldConnex[®] Diagnostic Server** in the project section and choose **Additional functions > Topology Scan and Import**.
9. Select **Scan Diagnostic Gateways**.

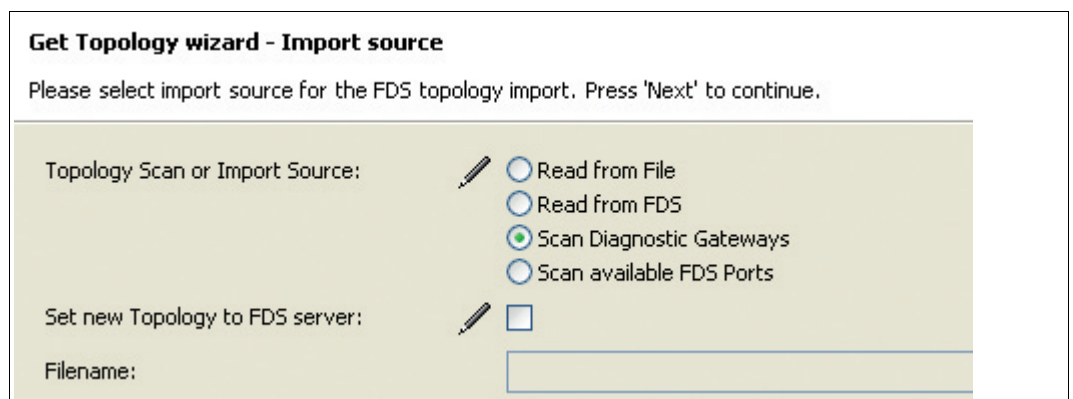

Figure 5.20 Topology Scan or Import Source

10. Choose **Next**.

11. If the diagnostic gateway is located in a different subnet, enter its IP address in the **Remote subnet IP address** field and choose **Add**. Then choose **Update** to find all diagnostic gateways in the subnet. To identify a gateway in the cabinet, select the gateway from the list and choose **Locate selected gateway(s)**.

IP Address	Tag of the Diagnostic Gateway	Subnet
Local Subnet		
<input checked="" type="checkbox"/> 172.24.114.40	KT-MB-GT2AD_1	Local
172.24.114.129 *		
<input checked="" type="checkbox"/> 172.24.114.129	Jens	172.24.114.129
<input checked="" type="checkbox"/> 172.24.114.164	Martin_SA-Board	172.24.114.129

Figure 5.21 Scanned gateways

12. Select the gateways to include in the project from the list of available gateways.
13. If required, you can set scan limits for the address range of the diagnostic devices in the **Lower Scan Limit** and **Upper Scan Limit** fields. Only HD2-DM-A addresses within the set limit will be scanned. This option can speed up the scanning process if only a few HD2-DM-A modules within a small address range are used in a project.
14. Choose **Next**.
 - ↳ The topology scan function scans for diagnostic modules within the restricted address range and builds up the diagnostic topology automatically.

5.4.7 Import of Diagnostic Project from File

The "Import from file" option is typically used for the advanced diagnostic module (ADM) integration package available for the major process control systems (PCS). See the application notes for the ADM integration packages for details.



Importing the Configuration from File

Before you start, ensure that the FieldConnex[®] diagnostic server (FDS) is running, the latest diagnostic manager is installed, and that the PACTware[™] device catalog is up-to-date.

1. Start **PACTware[™]**.
2. Open a PACTware[™] diagnostic project.
3. Choose **View > Device Catalog** to open the device catalog.
4. Open the **PEPPERL+FUCHS GmbH** device folder.

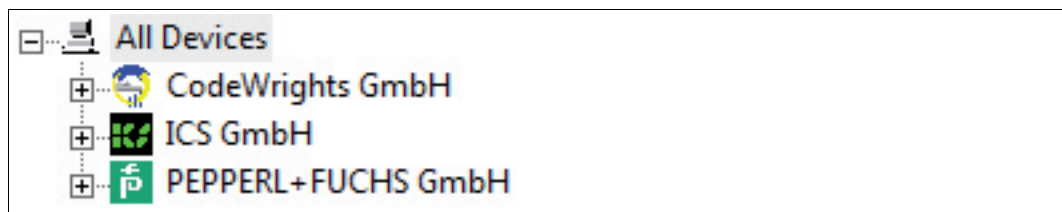

Figure 5.22 Structure in the PACTware[™] device catalog

5. Select the **Driver** folder.

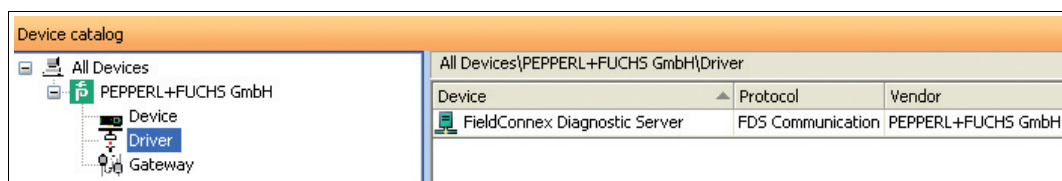

Figure 5.23 Device overview of the **Driver** folder

6. Drag the **FieldConnex[®]** Diagnostic Server entry from the device catalog section on the **HOST PC** entry in the project section.
7. Right-click the **FieldConnex[®]** Diagnostic Server in the project section and choose **Connect**.
8. Right-click the **FieldConnex[®]** Diagnostic Server in the project section and choose **Additional functions > Topology Scan and Import**.
9. Select **Read from File**.

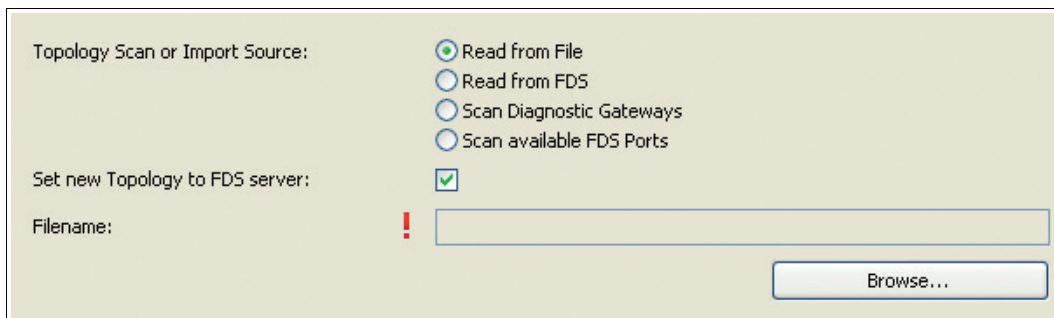

Figure 5.24 Topology scan or import source - Read from File

10. Choose **Browse** and select the file that contains the configuration you intend to import.
11. Choose **Next**.
↳ The wizard displays the configuration and the changes that will be made in your active project.
12. Choose **Next** to confirm the changed settings and follow the instructions of the wizard.

5.4.8 Import of Diagnostic Project from FDS

The diagnostic manager provides an import function that enables you to import existing configurations and topologies from the FieldConnex[®] diagnostic server (FDS). Furthermore, the wizard enables you to compare and update the current project with the data of an existing FDS configuration.



Importing the Configuration from FDS

Before you start, ensure that the FieldConnex[®] diagnostic server (FDS) is running, the latest diagnostic manager is installed, and that the PACTware[™] device catalog is up-to-date.

1. Start **PACTware[™]**.
2. Open a PACTware[™] diagnostic project.
3. Choose **View > Device Catalog** to open the device catalog.
4. Open the **PEPPERL+FUCHS GmbH** device folder.

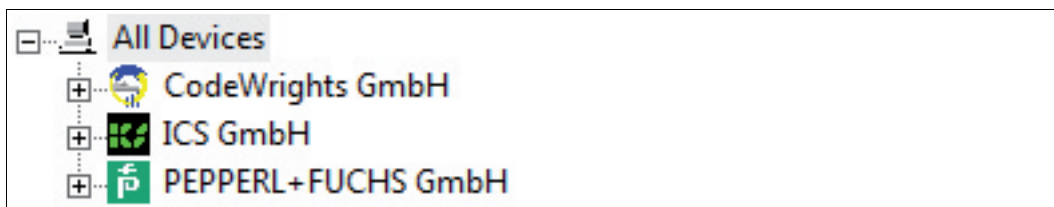

Figure 5.25 Structure in the PACTware[™] device catalog

5. Select the **Driver** folder.

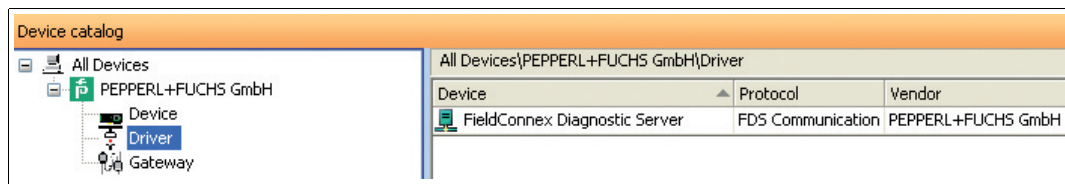

Figure 5.26 Device overview of the **Driver** folder

6. Drag the **FieldConnex**[®] Diagnostic Server entry from the device catalog section on the **HOST PC** entry in the project section.
7. Right-click the **FieldConnex**[®] Diagnostic Server in the project section and choose **Connect**.
8. Right-click the **FieldConnex**[®] Diagnostic Server in the project section and choose **Additional functions > Topology Scan and Import**.
9. Select **Read from FDS**.

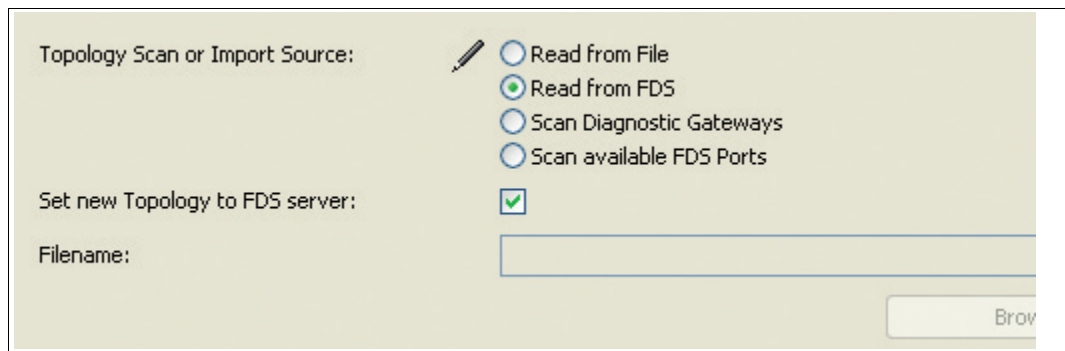

Figure 5.27 Topology scan or import source - Read from FDS

10. Choose **Next**.
↳ The wizard displays the configuration and the changes that will be made in your active project.
11. Choose **Next** to confirm the changed settings and follow the instructions of the wizard.

5.4.9 Set Snapshot Archive Location

By default, snapshots are stored in the diagnostic manager project file. For large fieldbus installations with many diagnostic devices, this project file increases rapidly. This can make file handling complicated.



Caution!

Large Project Files

Large project files may cause the software to slow down. We recommend that you store snapshot data in an external file if the expected number of snapshots exceeds 4 000.



Caution!

Data Loss

Once the snapshot data has been stored in an external file, it cannot be stored in the project file again without losing the externally stored snapshots.

To prevent data loss, establish a backup solution for the external snapshots.



Setting the Snapshot Archive Location



Note

Ensure that the directory where the snapshots will be saved already exists.

To change the snapshot archive location, proceed as follows:

1. Right-click the **FieldConnex**[®] Diagnostic Server in the project section and choose **Parameter**.
2. Select **Manual Configuration (HD2-DM-A only)** in the snapshot file location section.

Figure 5.28 Snapshot location

3. Enter the directory for the snapshot data in the **Snapshot File Path** field.
4. Choose **Apply** to confirm changed settings.

↳ The snapshot data will be stored in the **Snapshot.mdb** file, which is automatically created in the dedicated snapshot directory.

5.5

Operation with Device Type Managers (DTM)

The FDT/DTM based diagnostic manager is the graphic interface for the user of advanced diagnostic modules (ADM). The ADM contains all configuration settings, diagnostic information, and device functionalities.

Before reading this chapter on the functionality of the diagnostic manager DTMs, see chapter 2 and see chapter 8.10.



Note

Some functions and features are available only if the latest firmware version is installed on the HD2-DM-A module. A firmware supporting all features is integrated with this DTM and can be installed on any HD2-DM-A hardware. See chapter 7.11

Main Functions of the Diagnostic Manager

Online parameterization See chapter 5.6	This is the main interface. It provides a short overview of the system and segments settings. Furthermore, it contains the Related Tasks quick start section which enables you to access key features like segment commissioning, diagnostics, etc.
Commissioning wizard See chapter 5.6.3	The commissioning wizard is a tool for fast and easy system setup with ADM. It guides you through the entire setup process with system and segment calculation.
Diagnostics See chapter 5.7	The diagnostics function displays all alarms that have occurred at a glance.
Measured value See chapter 5.8	This function enables fast validation of a new or reworked fieldbus installation. It displays a qualitative rating of the relevant segment and field device data. In order to save the results as a report, this function enables you to create a snapshot of the measured values.
Snapshot explorer See chapter 5.9	The snapshot explorer simplifies administration and enables printing of existing snapshots and reports.
Parameterization See chapter 5.10	This is an offline interface, which means that you can change these settings without having a direct connection to the diagnostic device. This interface enables you to define the power supply, the alarm settings, and the field devices per segment.
Advanced parameterization See chapter 5.10	This interface enables detailed access to all possible settings of the HD2-DM-A. It is for advanced parameterization and can be used to adjust the HD2-DM-A to some more seldom use cases not covered by the automatic tools like the commissioning wizard.
History export See chapter 5.11	Allows exporting the history data automatically record by the HD2-DM-A.
Fieldbus oscilloscope See chapter 5.12	The fieldbus oscilloscope is the perfect tool for in-depth analysis of the fieldbus signal.
Firmware update See chapter 5.13	The firmware update function enables you to update the firmware of a selected advanced diagnostic module (ADM).

5.6 Online Parameterization

5.6.1 Overview

The online parameterization interface is the main user interface of the diagnostic manager. It enables access to the most common functions and to the current segment data.



Opening the Online Parameterization Window

To open the online parameterization window, proceed as follows:

1. Right-click an **Advanced Diagnostic Module** in the project section.
2. Choose **Parameter > Online Parameterization**.

↳ The online parameterization window appears.

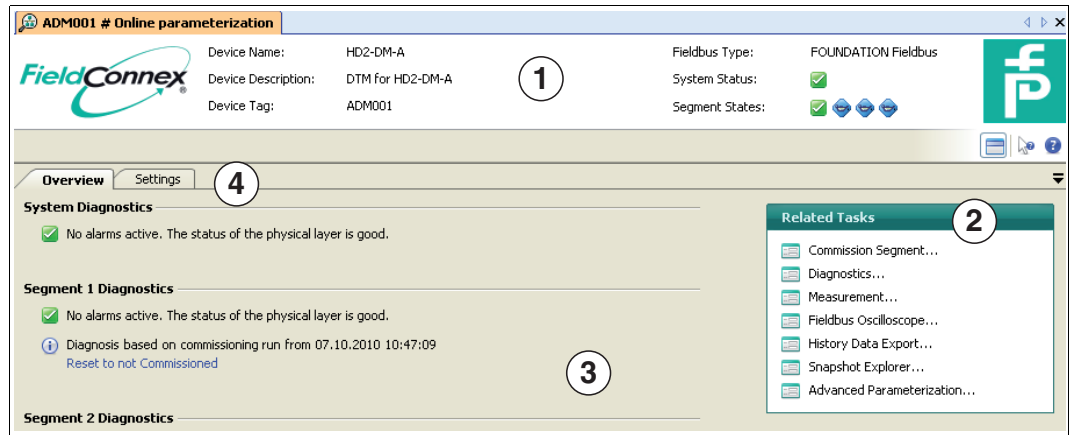

Figure 5.29 Online parameterization window

- 1 General diagnostic module information
- 2 Quick start section
- 3 System and segment status information
- 4 Function tabs

5.6.2 Settings

The **Settings** tab enables you to adjust segment settings, for example the fieldbus type and the recording intervals for the long-term history storage. The history function enables you to collect and export data in well-defined time intervals. See chapter 5.11.

Furthermore, the **Settings** tab displays the serial number of the diagnostic device and the firmware version that is installed on the device.

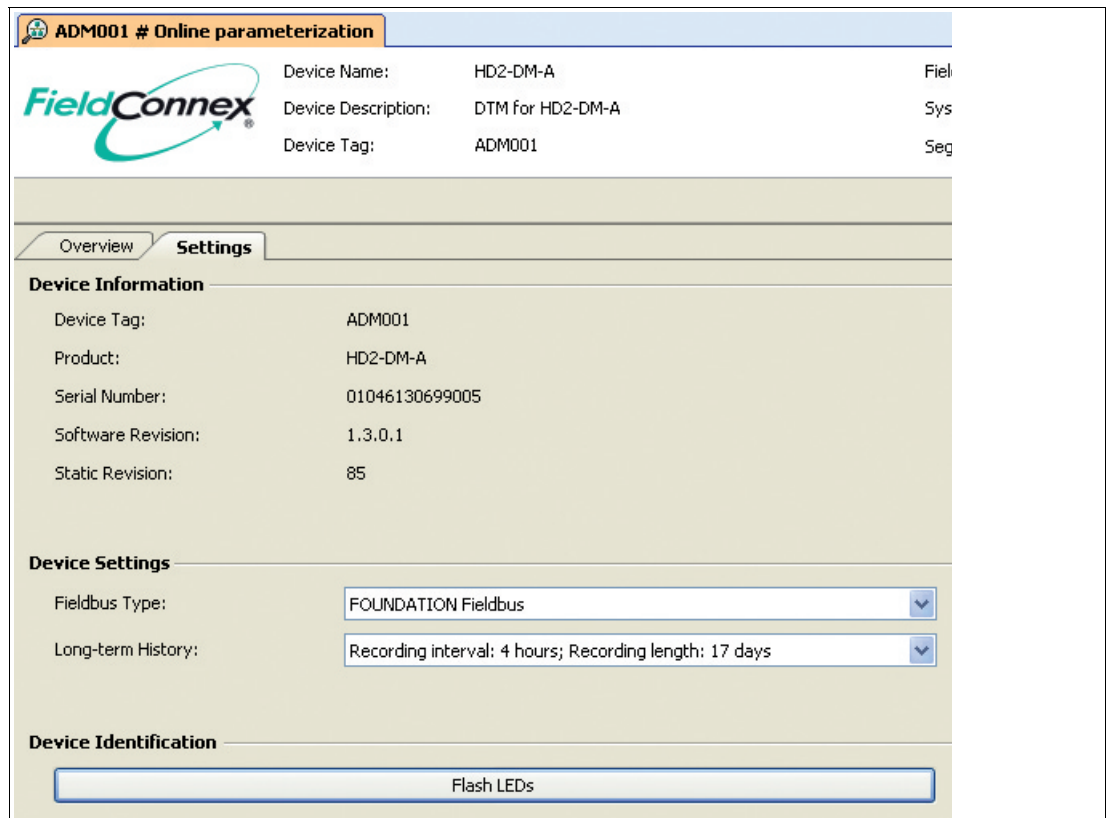

Figure 5.30 Online parameterization settings window

5.6.3 Commissioning Wizard

The commissioning wizard is a tool for fast and easy system setup with advanced diagnostic modules (ADM). It guides the user through the system and segment set up and determines the system and segment data of your fieldbus installation. Based on this information, the commissioning wizard proposes limit values for all system, segment, and field device alarm values. If necessary, you can edit the limit values or store them on the ADM. After the commissioning wizard has been completed successfully, the ADM is ready for plant real-time monitoring.



Opening the Commissioning Wizard

In order to open the commissioning wizard, proceed as follows:

1. Right-click the **Advanced Diagnostic Module** in the project section.
2. Choose **Additional Functions > Commissioning Wizard**.

↳ The commissioning wizard window appears.

Commissioning Wizard Start Page

Please start the Automated Commissioning procedure for the System or for a Segment. Unused Segments can be disabled.

General

Fieldbus Type: FOUNDATION Fieldbus

System Commissioning

System Commissioning

Segment Commissioning

Segment 1	<input checked="" type="checkbox"/> Enable Segment	
Segment 2	<input type="checkbox"/> Enable Segment	-
Segment 3	<input type="checkbox"/> Enable Segment	-
Segment 4	<input type="checkbox"/> Enable Segment	-

HD2-DM-A.RO Settings

Generate RO Report

Figure 5.31 Commissioning wizard window

5.6.4 System Commissioning



Performing System Commissioning with the Commissioning Wizard

In order to perform system commissioning, proceed as follows:

1. Open the commissioning wizard. See chapter 5.6.3
2. Select your fieldbus type from the **Fieldbus Type** drop-down list.
3. Choose **System Commissioning**.

↳ The system displays the current motherboard and power supply data.

4. Choose **Next**.

↳ The system takes a snapshot and displays the current system data with the automatically calculated maintenance and limits alarms.

5. If necessary, you can modify these values before storing them on the advanced diagnostic module. Note that the out-of-specification alarm for the primary and secondary power supply will be enabled automatically by default.
6. Choose **Next**.
 - ↳ System warning and alarm limit values are now stored on the diagnostic device.

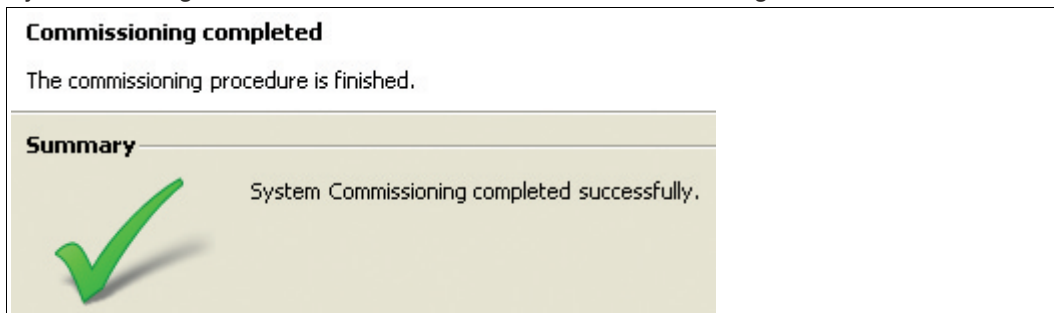

Figure 5.32 System commissioning succeeded

7. Choose **Restart** to confirm changed settings and to return to the commissioning wizard start page.

5.6.5 Segment Commissioning



Performing Segment Commissioning with the Commissioning Wizard

To perform segment commissioning, proceed as follows:

1. Open the commissioning wizard. See chapter 5.6.3
2. Perform system commissioning. See chapter 5.6.4
3. In the segment commissioning section of the commissioning wizard start page choose the **Segment** you want to commission.
 - ↳ The topology settings window appears.
4. Choose **Next**.
 - ↳ The field device tags window appears.
5. Choose **Next**.
 - ↳ Current segment measurements and field device signal level tabs are shown.
6. Choose **Next**.
 - ↳ The system takes a snapshot and generates a printable report that is stored in the snapshot explorer. See chapter 5.9. In case the expert system detects any issues while recording the snapshot, ensure to ignore these if you intend to proceed with the commissioning. Not ignoring them will cancel the commissioning procedure and generate a report of the failed commissioning. Before the report is generated, you can add a comment to the report and select an option to include characteristic oscilloscope recording fragments for each field device to the report.
7. Choose **Next**.
 - ↳ The physical layer measurement report appears.
8. Choose **Next**.
 - ↳ Current system data with automatically calculated limits are shown.

9. Choose **Next**.

↳ System warning and alarm limit values are now stored on the diagnostic device.

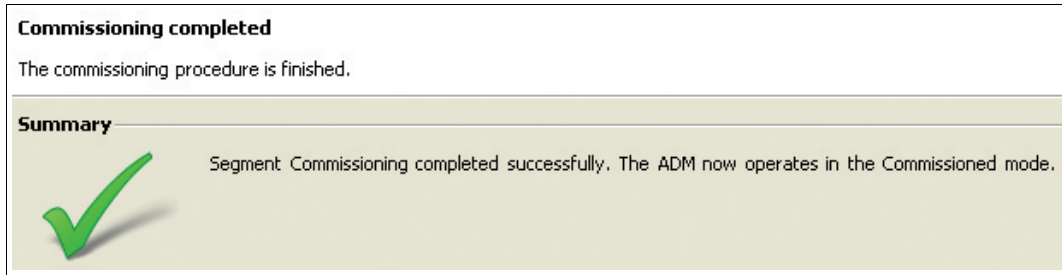

Figure 5.33 Segment commissioning succeeded

10. Choose **Restart** to confirm changed settings and to return to the commissioning wizard start page.

11. Repeat segment commissioning for the remaining segments.

5.6.6 Generate Report for HD2-DM-A.RO DIP Switch Settings

Once commissioning of all 4 segments is complete, the commissioning wizard supports generation of a report with the correct DIP switch settings for the HD2-DM-A.RO module.

Generating a HD2-DM-A.RO Settings Report

In order to generate a settings report for the HD2-DM-A.RO module, proceed as follows:

1. Open the commissioning wizard. See chapter 5.6.3
2. Perform system commissioning. See chapter 5.6.4
3. Perform segment commissioning. See chapter 5.6.5
4. In the HD2-DM-A.RO settings section of the commissioning wizard start page, choose **Generate RO Report**.

↳ The system generates a report that can be printed and saved.

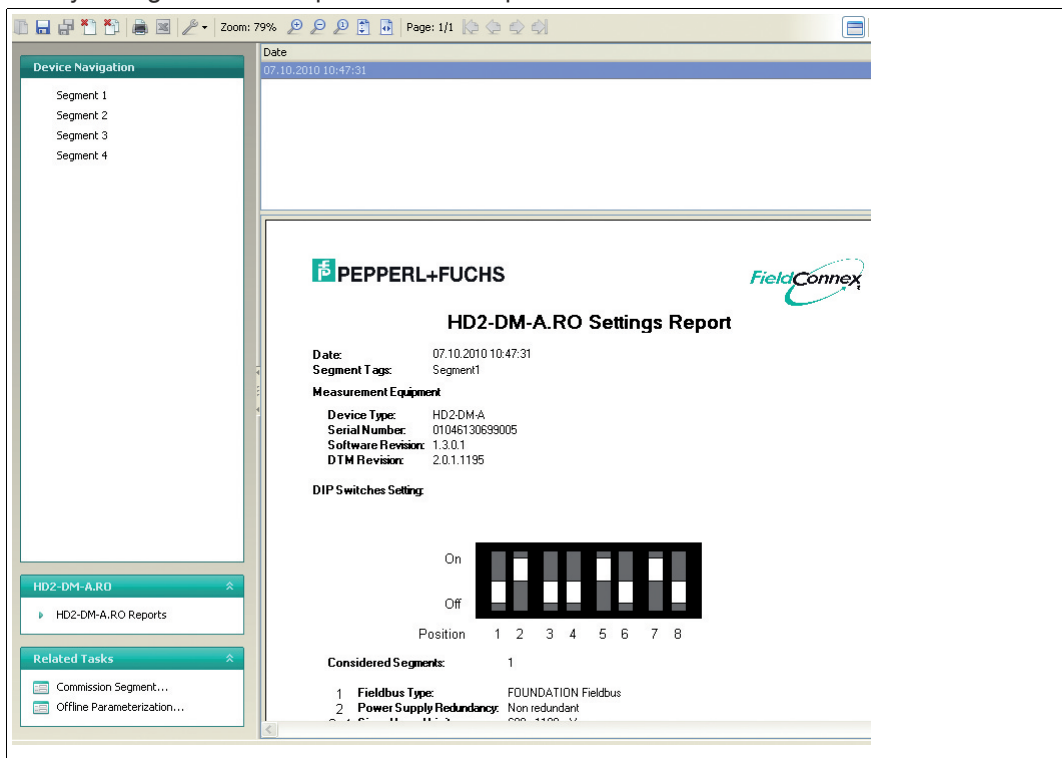

Figure 5.34 Snapshot explorer - HD2-DM-A.RO settings report

5.7 Diagnostics

The diagnostics function is for troubleshooting after an alarm of the advanced diagnostic module (ADM) appeared in the process control system (PCS). It displays the currently active expert messages, as well as all active alarms and a history of the last 500 alarms detected by the ADM.

5.7.1 Expert Diagnostics

The expert diagnostics tab shows all expert messages of the selected segment, including a description of the detected phenomenon, a list of possible causes for the phenomenon and actions suggested to fix the issue.



Opening the Expert Diagnostics Tab

To open the expert diagnostics tab, proceed as follows:

1. Right-click the **Advanced Diagnostic Module** in the project section.
2. Choose **Diagnosis**.

↳ The expert diagnostics window appears.

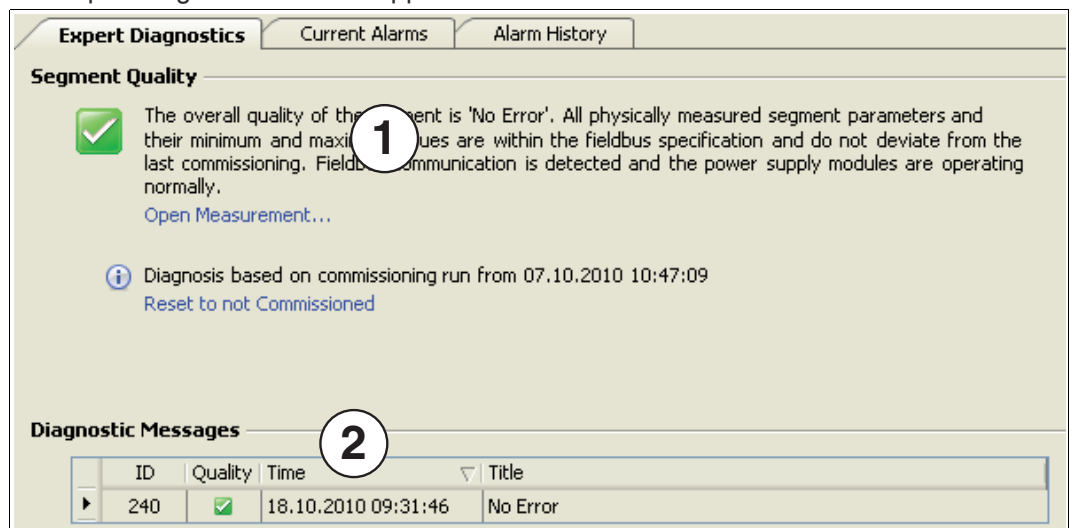

Figure 5.35 Expert diagnostics window

- 1 Overall segment quality
- 2 Summary diagnostic messages

5.7.2 Current Alarms Diagnostics Tab

On the current alarms tab all active advanced diagnostic module (ADM) alarms are displayed. This tab shows all the active alarms from which the expert messages that are displayed on the expert diagnostics tab are derived.

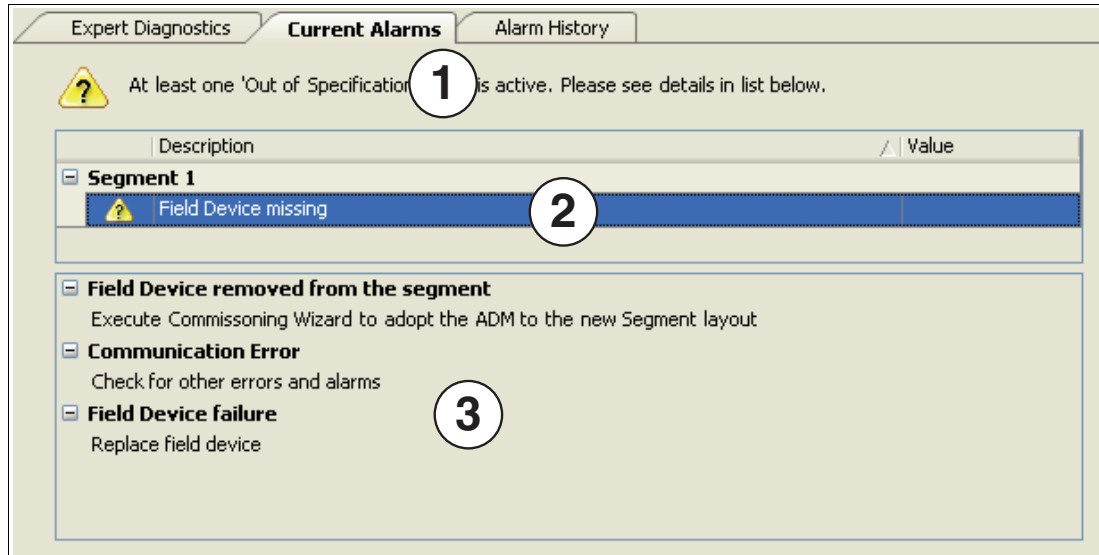

Figure 5.36 Current alarms tab

- 1 Alarm summary
- 2 Segment and field device alarm
- 3 Possible cause and troubleshooting information

5.7.3 Alarm History Diagnostics Tab

An alarm history is recorded automatically by the advanced diagnostic module (ADM) for the last 500 active alarm events. The alarm history tab shows the history including a timestamp when the event occurred.

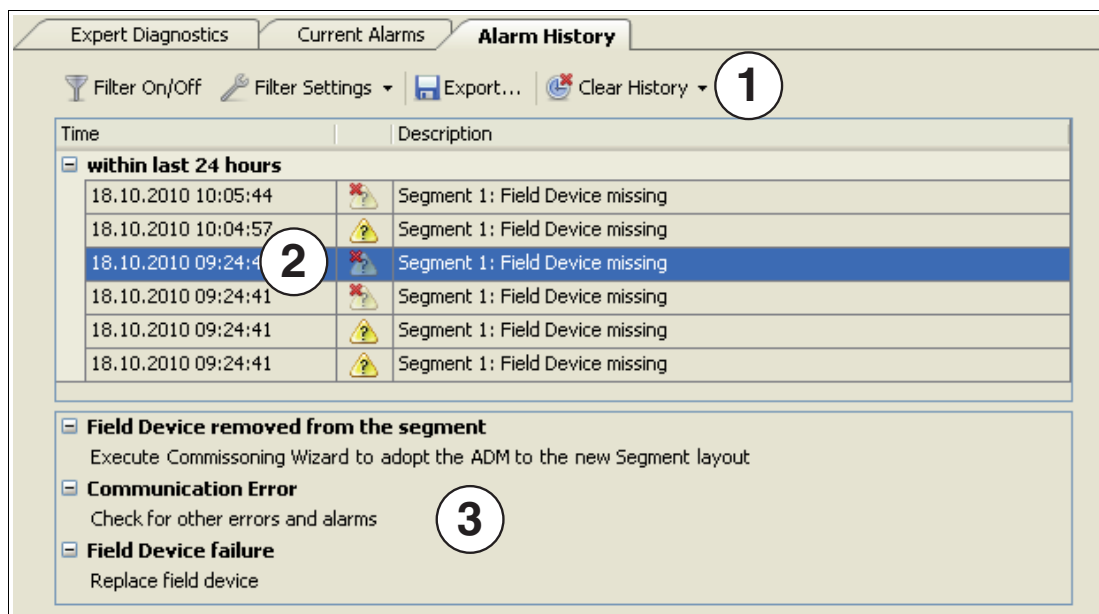

Figure 5.37 Alarm history tab

- 1 Filter function, filter settings, history export and clear history
- 2 Alarm history
- 3 Possible cause and troubleshooting information

Alarm Icon Description

Each alarm in the alarm history column is shown with date, time, address, and type.

The alarm icon indicates whether the alarm is still active or whether it is inactive, i.e., the alarm situation is already over. See the example below.

Time		Description
[-] within last 24 hours		
18.10.2010 10:05:44		Segment 1: Field Device missing
18.10.2010 09:04:57		Segment 1: Field Device missing
18.10.2010 09:24:41		Segment 1: Field Device missing
18.10.2010 09:24:41		Segment 1: Field Device missing
18.10.2010 09:24:41		Segment 1: Field Device missing

Figure 5.38 Alarm icons: Active and inactive alarms

- 1 Active alarm
- 2 Inactive alarm

Filter Settings

The system displays all alarm messages by default. The filter enables you to create different views of the alarm history and to narrow down the history list.

The system includes different types of filters:

- Common filters that enable you to activate/deactivate all filters or display active alarms only.
- Filters for system-specific alarms.
- Filters for segment-specific alarms.
- Filter for field-device-specific alarms. Note that if you set a field device alarm, you can reduce the view onto specific field devices by using the address filter drop-down list.

Filter On/Off

Use the **Filter On/Off** button to activate or deactivate the filtered view.

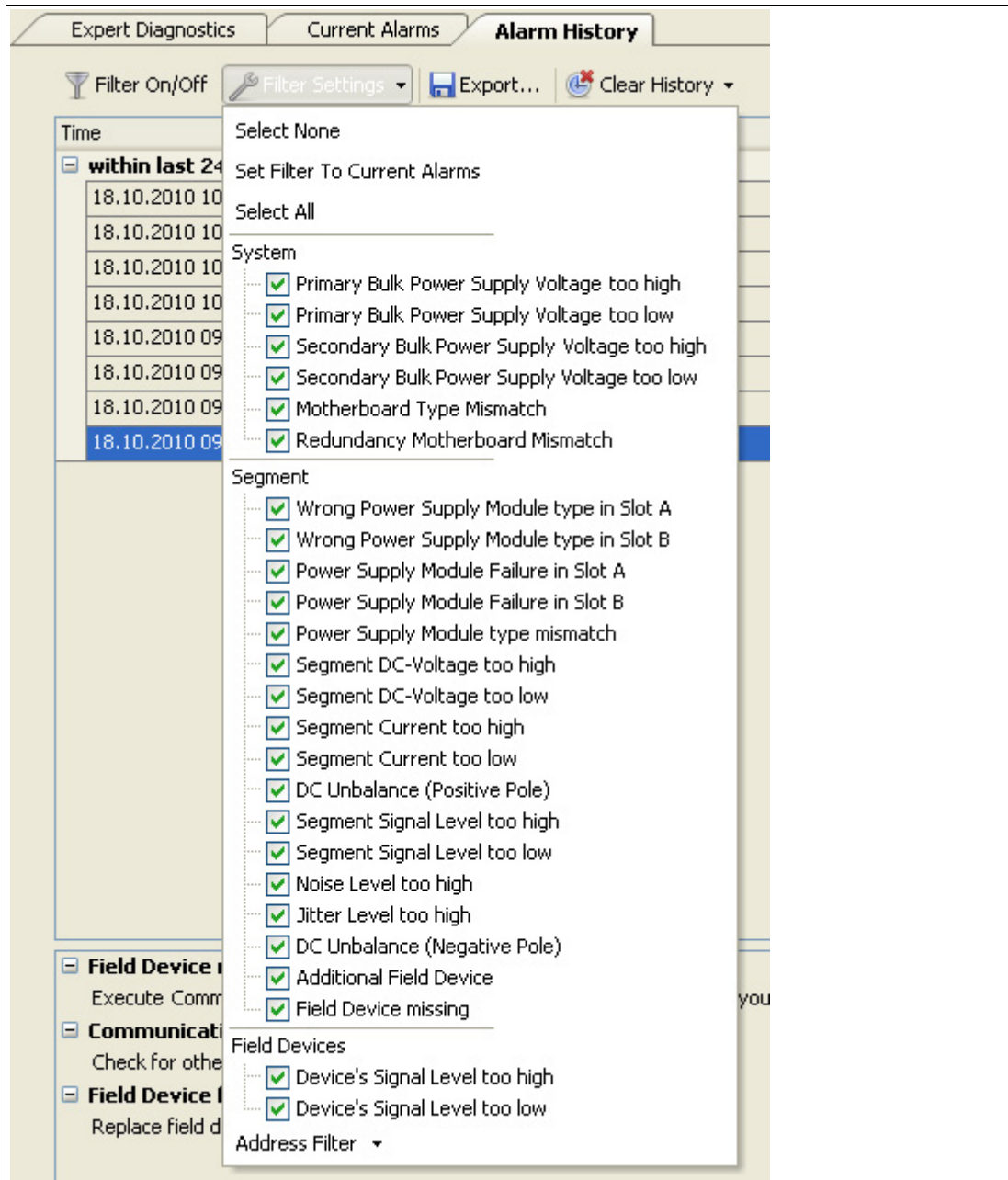

Figure 5.39 Alarm history toolbar and filter settings



Exporting the Alarm History



Note

The system always saves the complete history, independent of the filter settings.

1. Select a segment from the **Device Navigation** list.
2. Choose **Export** on the alarm history tab.
3. Enter the file name, type, and directory in the **Export Alarm History** section.
4. Choose **Save** to export the alarm history file.

5.8 Measured Value

5.8.1 System & Segment Measurement

The system & segment measurement function allows for fast validation of a new or reworked fieldbus installation. It provides a brief overview of the segment health and enables you to perform a detailed analysis.

You can also go to other functions right out of the **Related Tasks** section.



Opening the System and Segment Measurement

In order to open the system and segment measurement window, proceed as follows:

1. Right-click the **Diagnostic Module** in the project section.
2. Choose **Measured value**.

↳ The system & segment measurements window appears.

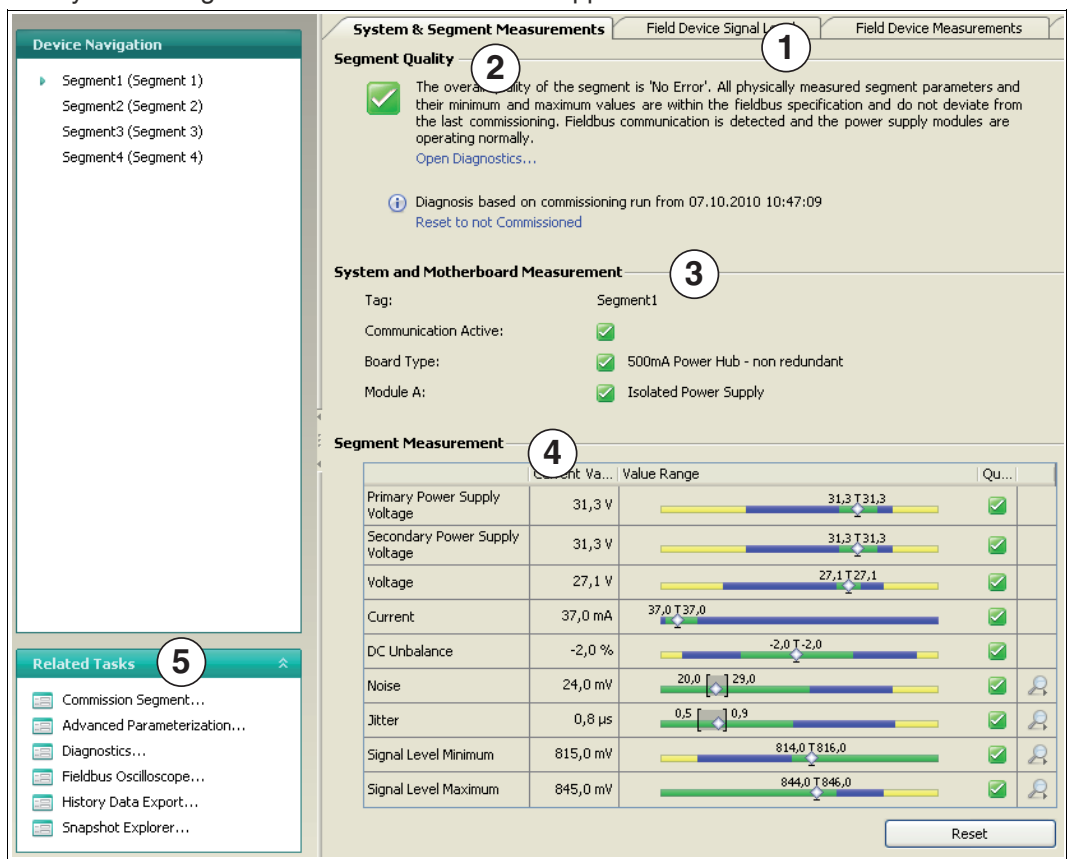

Figure 5.40 System & segment measurements overview

- 1 Function tabs
- 2 Segment overall quality
- 3 System and motherboard overall quality values
- 4 Segment measurements
- 5 Related tasks

The analog measurement values are shown using a graph shown in the figure below. The values are classified according to Excellent, Good, and Out of Specification for the uncommissioned mode and No Error, Maintenance Required and Out of Specification for the Commissioned mode, see chapter 2.2.

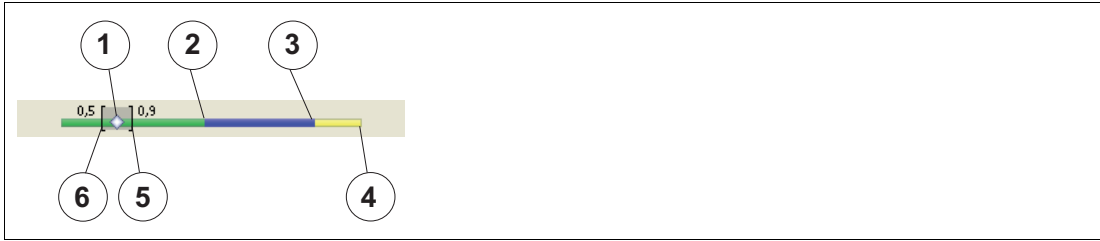

Figure 5.41 Signal level

- 1 Current value
- 2 Range for excellent value (green)
- 3 Range for good value (blue)
- 4 Range for exceeded value (yellow)
- 5 Maximum value occurred during operation
- 6 Minimum value occurred during operation

Magnifying Glass

Click on the magnifying glass to see current field device data.

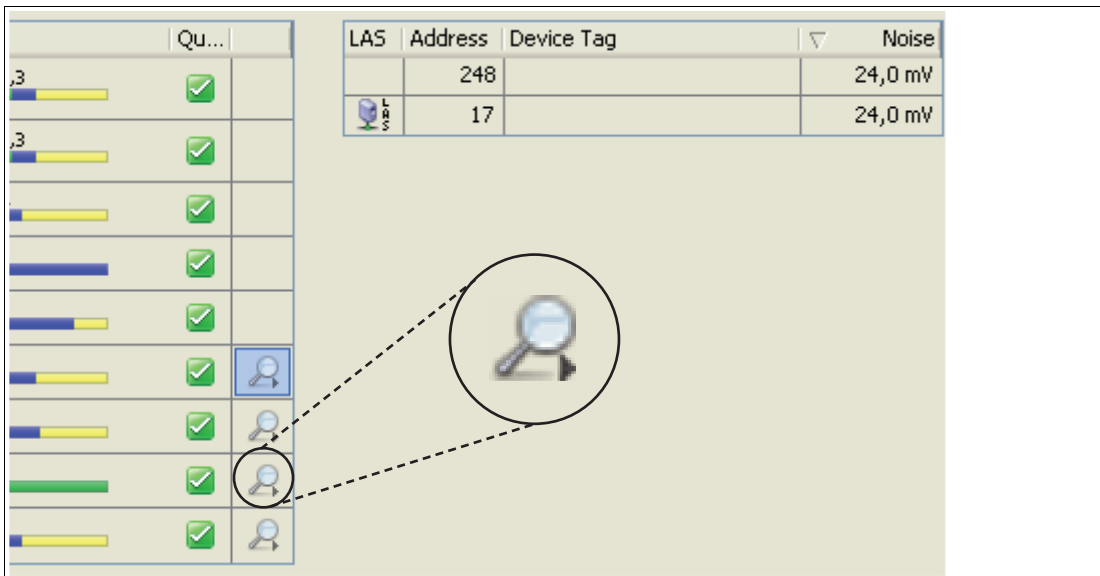

Figure 5.42 Magnifying glass

5.8.2 Field Device Signal Level

The field device signal level tab provides a graphical overview of the different devices and their signal level.

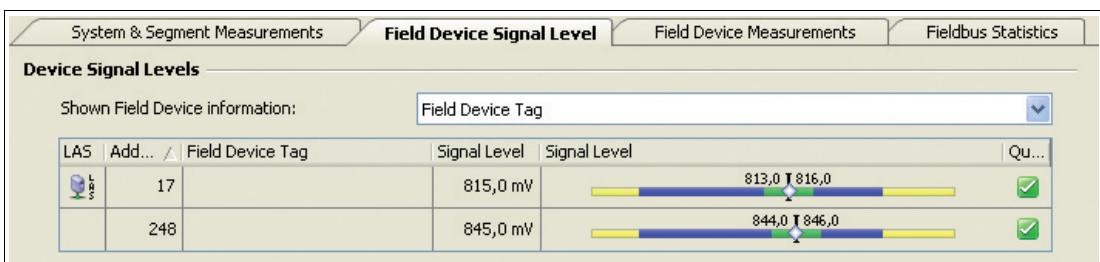

Figure 5.43 Field device signal level tab

5.8.3 Field Device Measurement

The field device measurements tab features a table that offers a live view of the essential physical layer values.

LAS	Add...	Field Device Tag	Signal Level	Noise	Jitter	Polarity	Live Li...	Pass T...
	17		815,0 mV	24,0 mV	0,7 µs	Standard	1	0
	248		845,0 mV	24,0 mV	0,7 µs	Standard	1	0

Figure 5.44 Field device measurements tab

5.8.4 Fieldbus Statistics

The fieldbus statistics tab provides a statistical overview of the communication frames received, errors, and other fieldbus values.

Frame Statistics	
Number of Received Frames:	15577
Number of CRC Errors:	0
Number of Framing Errors:	0
Error Rate:	0 %

Frame Statistics of last History Period

☀ Recording first History Period... (0 days, 3 hours and 25 minutes remaining)

FF Timing Settings	
Currently used Slot Time of this segment:	8
Maximum Response Delay:	10
Minimum Inter PDU Delay:	16

Figure 5.45 Fieldbus statistics tab

5.8.5 Snapshot Creation

A snapshot provides a detailed overview of the current segment settings and the communication quality. For data exchange, a snapshot including the current minimum and maximum noise, jitter, and signal level values of each device and the rated segment values can be printed or exported as an image, text, or PDF document.



Creating a Snapshot

In order to create a snapshot, proceed as follows:

1. Right-click the **Advanced Diagnostic Module** in the project section.

2. Choose **Measured value**.

↳ The system & segment measurements window appears.

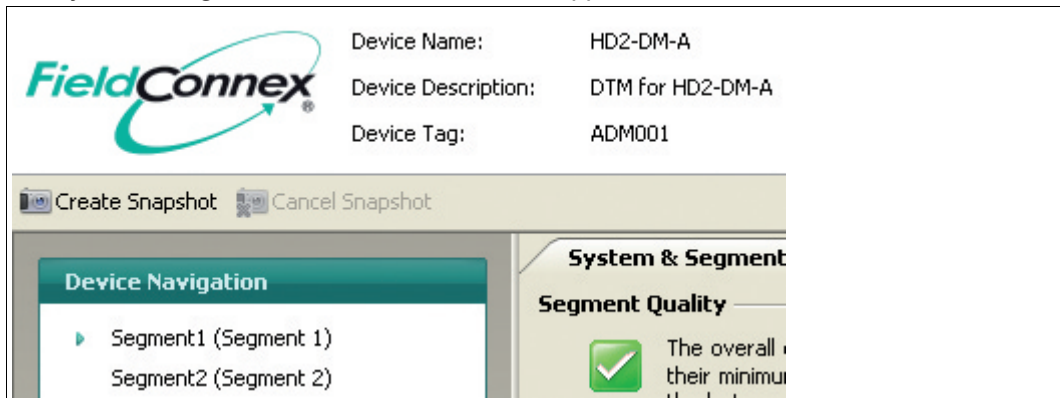

Figure 5.46 Create snapshot button

3. Choose **Create Snapshot** or **Create Snapshot including Oscilloscope Recordings**. The second option adds characteristic oscilloscope recording fragments for each field device to the report.

↳ Once all snapshot data is collected, the **Save Snapshot Report** window appears.

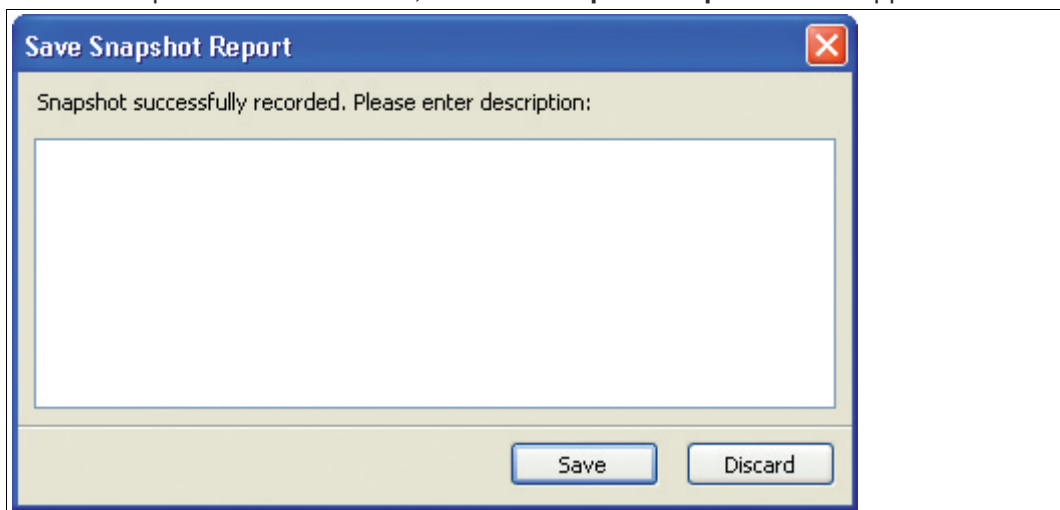

Figure 5.47 Save snapshot report window

4. Enter a description for the snapshot.
5. Choose **Save** to save the snapshot.

↳ The snapshot explorer window appears. See chapter 5.9

5.9 Snapshot Explorer

The snapshot explorer simplifies administration and enables the printout of existing snapshots and reports. These reports can be printed or exported as an image, text, PDF document, or diagnostic module snapshot (DMS) file. See chapter 5.8.5



Note

DMS is a file format for data exchange created by Pepperl+Fuchs.

2 different templates can be selected: A clearly arranged default template and a compact template that contains the same information using less space. You can export the report to Microsoft® Excel. This spreadsheet enables you to generate diagrams and perform individual calculations based on the report data.



Opening the Snapshot Explorer

In order to open the snapshot explorer, proceed as follows:

1. Right-click the **Advanced Diagnostic Module** in the project section.
2. Choose **Additional Functions > Snapshot Explorer**.

↳ The snapshot explorer window appears.

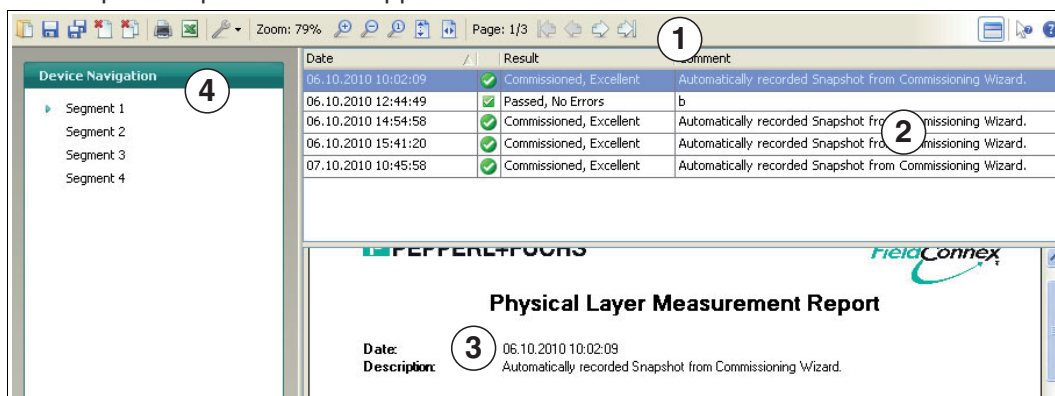









Figure 5.48 Snapshot screen overview

- 1 Toolbar
- 2 Snapshot collection
- 3 Report preview
- 4 Segment navigation panel

5.9.1 Snapshot Toolbar

Button	Name	Result
	Open	Open a saved report.
	Copy to (Export)	Copy the selected report to another location. File types: PDF, RTF, TXT, DMS
	Copy all to (Export all)	Copy all reports to another location. File type: DMS
	Delete	Delete the selected report.
	Delete all	Delete all reports.
	Print	Print the selected report.
	Excel	Export the selected report in Excel.
	Settings	Choose: <ul style="list-style-type: none"> • Paper size (A4 or letter) • Report type (compact template or detailed template)
	Zoom in	Enlarge the report.

Button	Name	Result
	Zoom out	Reduce the report.
	Zoom 100%	View of the report of 100 %.
	Fit to height	Fit the view of the report on the height.
	Fit to width	Fit the view of the report on the width.
	First page	Go to the first page of the report.
	Previous page	Go to the previous page of the report.
	Next page	Go to the next page of the report.
	Last page	Go to the last page of the report.

5.10 Advanced Parameterization and Parameterization

The diagnostic manager offers 2 user interfaces for detailed parameterization:

- Offline parameterization
- Online parameterization

These 2 interfaces allow tuning the behavior of all aspects of the advanced diagnostics. For typical operation, they are not required because measurement, commissioning wizard, and diagnostics offer a more advanced usage of the advanced physical layer diagnostics.

The main difference between the 2 user interfaces is their relationship to the advanced diagnostic module (ADM):

- Parameterization is an offline user interface. All data is stored in the FDT project. The data is not sent to the device until a download is executed. Use this user interface to view data loaded into the FDT project by an upload, e.g., for backup reasons.
- Advanced parameterization is an online interface. All changes are directly written to the device. The data is not stored automatically in the FDT project. In order to save the data to the FDT project, upload the data first.



Opening the Advanced Parameterization

In order to open the advanced parameterization window, proceed as follows:

1. Right-click the **Advanced Diagnostic Module** in the project section.
2. Choose **Additional Functions > Advanced Parameterization**.

↳ The advanced parameterization window appears.

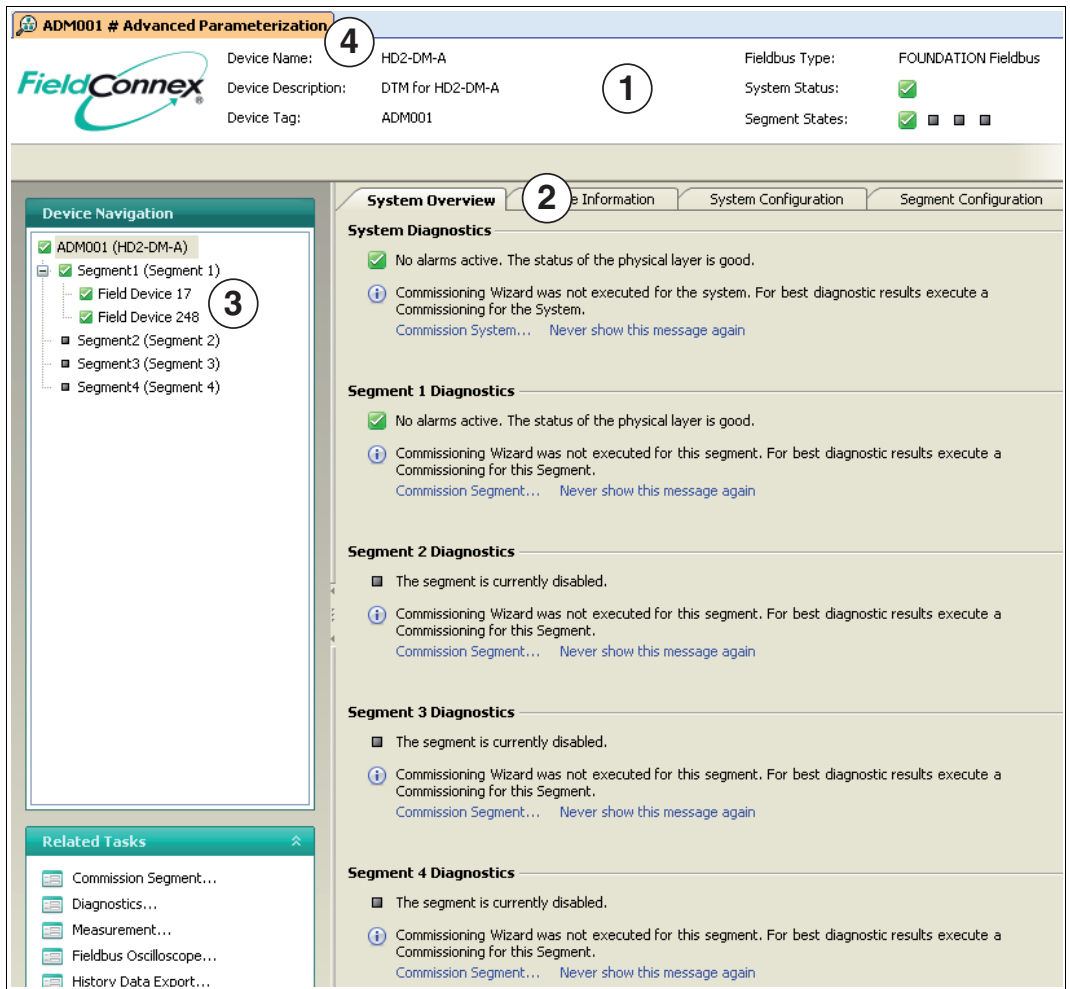

Figure 5.49 Advanced parameterization start window

- 1 General diagnostic module information
- 2 Function tabs
- 3 Segment/field devices selectable via tree. The preceding icon shows diagnostic state of field device.
- 4 Field device handling see chapter 5.10.1



Opening the Parameterization

To open the parameterization window, proceed as follows:

1. Right-click the **Advanced Diagnostic Module** in the project section and choose **Disconnect**.

- Right-click the **Advanced Diagnostic Module** in the project section and choose **Parameter > Parameterization**.

↳ The parameterization window appears.

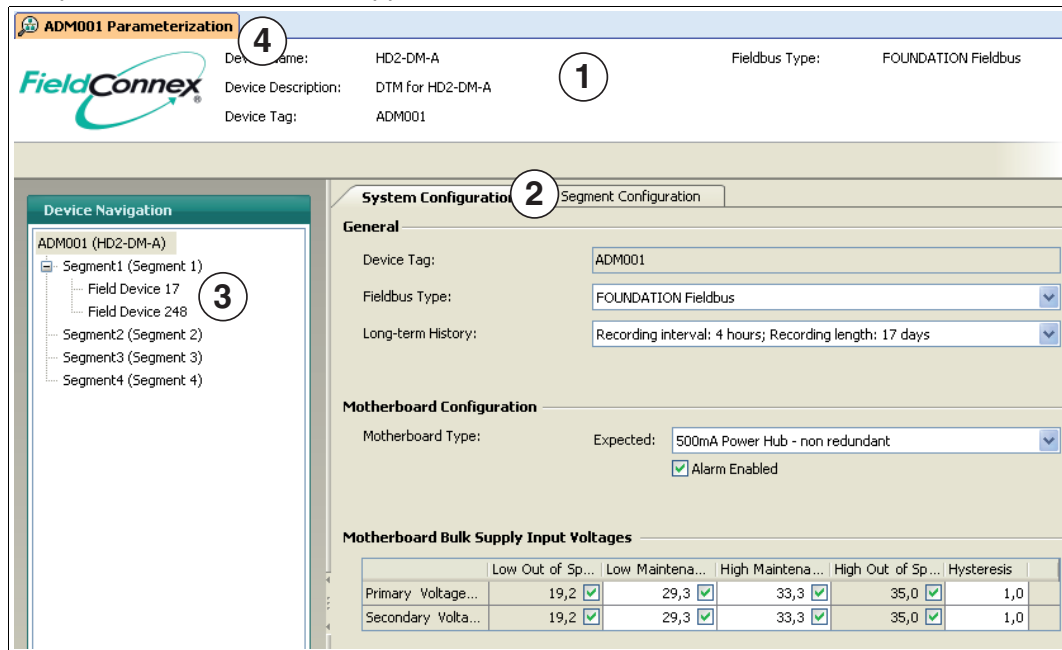

Figure 5.50 Parameterization start window

- General diagnostic module information
- Function tabs
- Segment/field devices are selectable via tree. The preceding icon shows diagnostic state of field device.
- Field device handling see chapter 5.10.1

Components Overview

Components	Tabs and Settings
Diagnostic module	System configuration <ul style="list-style-type: none"> General Motherboard configuration Motherboard bulk supply input voltage
	Segment configuration <ul style="list-style-type: none"> Segment 1 ... 4 (enable segment)
Segment	Segment configuration <ul style="list-style-type: none"> General Fieldbus supply module properties Measurement alarm settings
	Segment topology settings <ul style="list-style-type: none"> Topology Settings
	Field devices <ul style="list-style-type: none"> General Configured field devices
Field device	<ul style="list-style-type: none"> General Device information Settings

**Note**

For more information on the parameters, see chapter 5.8.

5.10.1 Field Device Handling

The advanced diagnostic module (ADM) classifies the field devices as configured field devices and unconfigured field devices. See also see chapter 2.2.4. The advanced parameterization allows for either of the following configured device list actions:

- Add unconfigured field devices
- Add new configured field devices
- Remove configured field devices that are no longer required



Adding an Unconfigured Field Device

In order to add an unconfigured field device, proceed as follows:

1. Right-click the **Advanced Diagnostic Module** in the project section and choose **Additional Functions > Advanced Parameterization**.
↳ The advanced parameterization window appears.
2. Select the segment in the **Device Navigation** section.
↳ The segment window appears.
3. Select the **Field Devices** tab.
4. Mark the field devices you intend to add in the **Unconfigured Field Devices** section.
5. Choose **Add selected Field Device**.

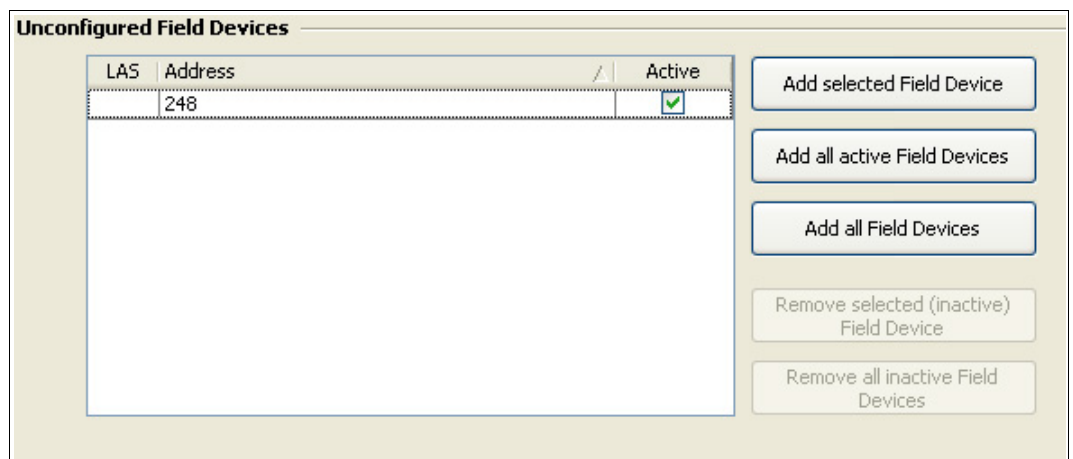

Figure 5.51 Unconfigured field devices section

↳ The new field device is located in the configured field devices list.

6. Choose **Apply**.



Adding a New Field Device

In order to add a new field device, proceed as follows:

1. Right-click the **Advanced Diagnostic Module** in the project section and choose **Additional Functions > Advanced Parameterization**.
↳ The advanced parameterization window appears.
2. Select the segment in the **Device Navigation** section.
↳ The segment window appears.

3. Select the **Field Devices** tab.
4. Choose **Add new Field Device** in the configured field devices section.

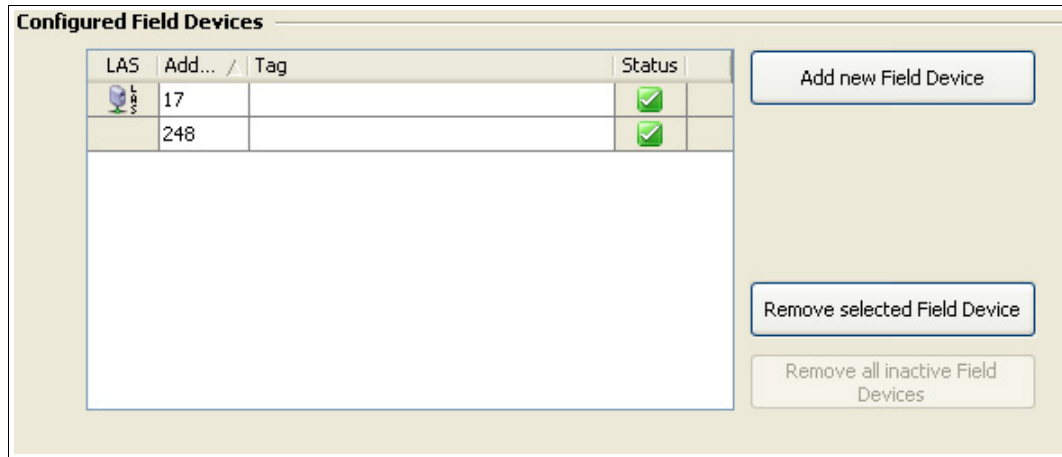

Figure 5.52 Configured field devices section

↳ The new field device is located in the configured field devices list.

5. Choose **Apply**.

Removing a Field Device

In order to remove a field device, proceed as follows:

1. Right-click the **Advanced Diagnostic Module** in the project section and choose **Additional Functions > Advanced Parameterization**.
↳ The advanced parameterization window appears.
2. Select the segment in the **Device Navigation** section.
↳ The segment window appears.
3. Select the **Field Devices** tab.
4. Mark the field device you want to remove in the **Configured Field Devices** section.
5. Choose **Remove selected Field Device**.
↳ The selected field device is removed from the configured field devices list.
6. Choose **Apply**.

Remove all Inactive Field Devices

To remove all inactive field devices, proceed as follows:

1. Right-click the **Advanced Diagnostic Module** in the project section and choose **Additional Functions > Advanced Parameterization**.
↳ The advanced parameterization window appears.
2. Select the segment in the **Device Navigation** section.
↳ The segment window appears.
3. Select the **Field Devices** tab.
4. Choose **Remove all inactive Field Devices** in the configured field devices section.
↳ All inactive field devices are removed from the configured field devices list.
5. Choose **Apply**.

5.11 History Export

5.11.1 Long-Term History

The long-term history function enables you to collect and store data in well-defined recording intervals. The minimum and maximum values of each measured value within the recording interval are stored as 1 data set. Recording intervals can range from 4 hours up to 7 days.



Note

The data storage is limited to 100 data sets. New data sets will overwrite existing ones, i.e., data set 101 overwrites data set 1.

Depending on the defined recording interval, the long-term history can range from 17 days (4 h * 100 = 400 h = approx. 17 days) up to approx. 2 years.



Defining the Recording Interval

In order to define the recording interval for the long-term history, proceed as follows:

1. Right-click the **Advanced Diagnostic Module** in the project section.
2. Choose **Parameter > Online Parameterization**.
3. Select the required recording interval from the **Long-term History** drop-down list in the device settings section.

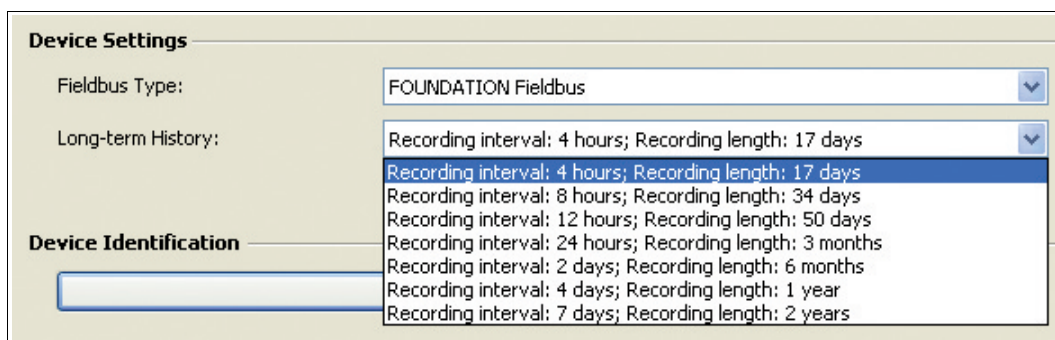

Figure 5.53 Long-term history drop-down list with different intervals

4. Choose **Apply** to confirm changed settings.

5.11.2 Export History

The export function enables you to convert the long-term history data into a commonly used document format, in order to use this data for your own calculations. The long-term history can be exported as Microsoft® Excel document, comma-separated values (CSV file), or binary history file (HIS).



Exporting the History Data

In order to export the long-term history data, proceed as follows:

1. Right-click the **Advanced Diagnostic Module** in the project section.
2. Choose **Additional Functions > History Export**.
3. Select the segment and choose **Start**.
4. Select the required file format in the **Export Type** section and enter a file name in the **Filename** field.

Figure 5.54 Export type and export settings

5. Choose **Next**.
6. After the export is complete, you can close the export function or choose **Restart** to export the long-term history for another segment.

5.11.3 Excel Export Feature

The diagnostic manager provides feature for exporting history data to Microsoft® Excel that enables fast and easy data exchange and reformatting of your physical layer data.

The physical layer data is exported into a special template. This template is designed to provide a detailed overview of all relevant parameters and enables you to create diagrams with one click.

		Primary Volt. /V		Secondary Volt. /V		Voltage /V	
		Maximum	Minimum	Maximum	Minimum	Maximum	
24	Average	31,30	31,30	31,30	31,30	27,10	
25	Standard Deviation	0,00	0,00	0,00	0,00	0,00	
26	Maximum	31,30	31,30	31,30	31,30	27,10	
27	Minimum	31,30	31,30	31,30	31,30	27,10	
32	Remove entries	Primary Volt. /V		Secondary Volt. /V		Voltage /V	
33		Maximum	Minimum	Maximum	Minimum	Maximum	
34	1465	13:24, 18.10.2010	31,3	31,3	31,3	31,3	27,1
35	1466	14:57, 18.10.2010	31,3	31,3	31,3	31,3	27,1

Figure 5.55 History data overview in Excel

5.12 Fieldbus Oscilloscope

5.12.1 Oscilloscope Recording Settings

The built-in oscilloscope enables in-depth analysis of the fieldbus signal level during a defined time period, for example, if a specific telegram type was detected or if communication issues occurred.



Opening the Fieldbus Oscilloscope

In order to open the fieldbus oscilloscope, proceed as follows:

1. Right-click the **Advanced Diagnostic Module** in the project section.
2. Choose **Additional Functions > Fieldbus Oscilloscope**.

↳ The fieldbus oscilloscope window appears.

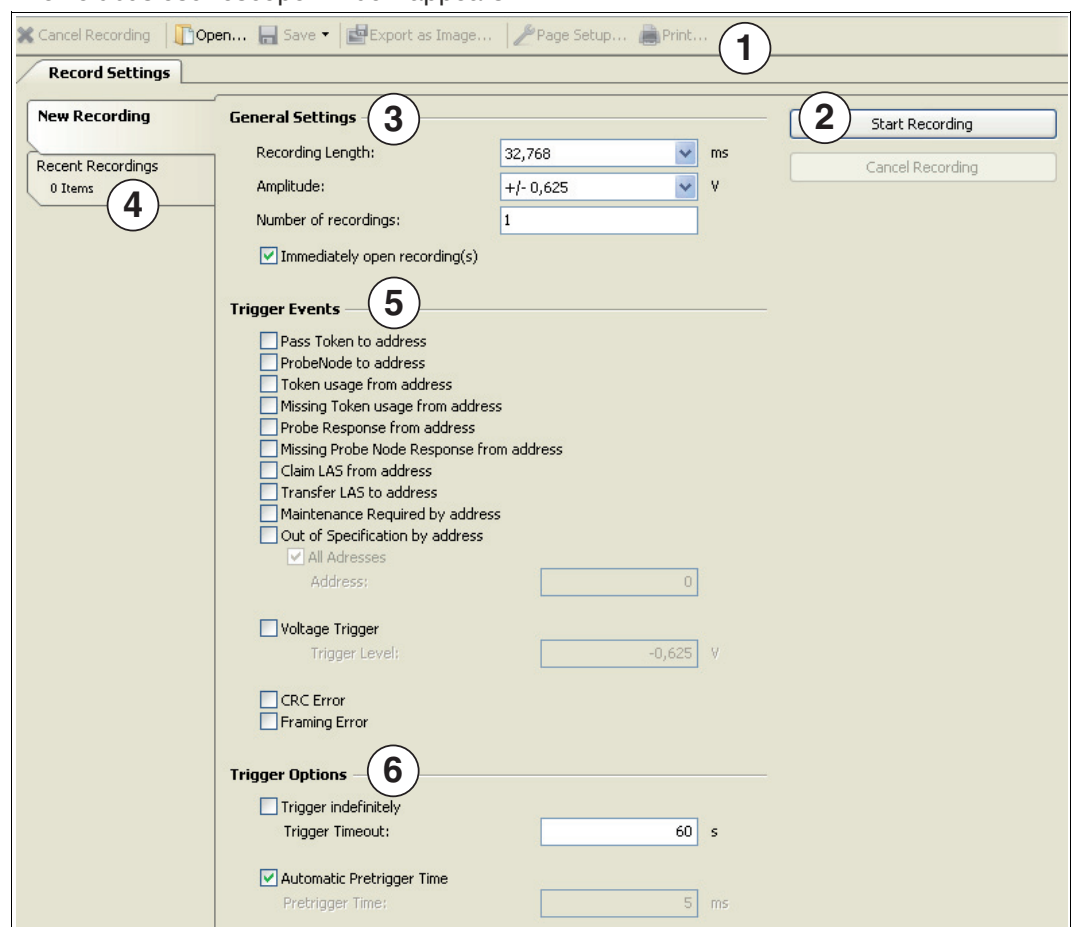

Figure 5.56 Record settings overview

- 1 Record toolbar
- 2 Start/cancel signal recording
(depending in the system, a reaction delay of up to 5 s is possible)
- 3 Recording length
default value = 32.768 ms/sample rate = 2 MS/s
- 4 Recent recordings tab
- 5 Trigger events
- 6 Trigger options

Recent Recordings

All oscilloscope recordings taken during one session are shown in the recent recordings section.



Note

If you close the oscilloscope dialog, all unsaved recordings are lost.

5.12.2

Start Oscilloscope Recording



Starting the Recording

In order to start the oscilloscope recording, proceed as follows:

1. Right-click the **Advanced Diagnostic Module** in the project section.
2. Choose **Additional Functions > Fieldbus Oscilloscope**.
↳ The fieldbus oscilloscope window appears.
3. You can select various trigger events in the **Trigger Events** section. See chapter 5.12.3
4. Choose **Start Recording**.
↳ The oscilloscope window appears.

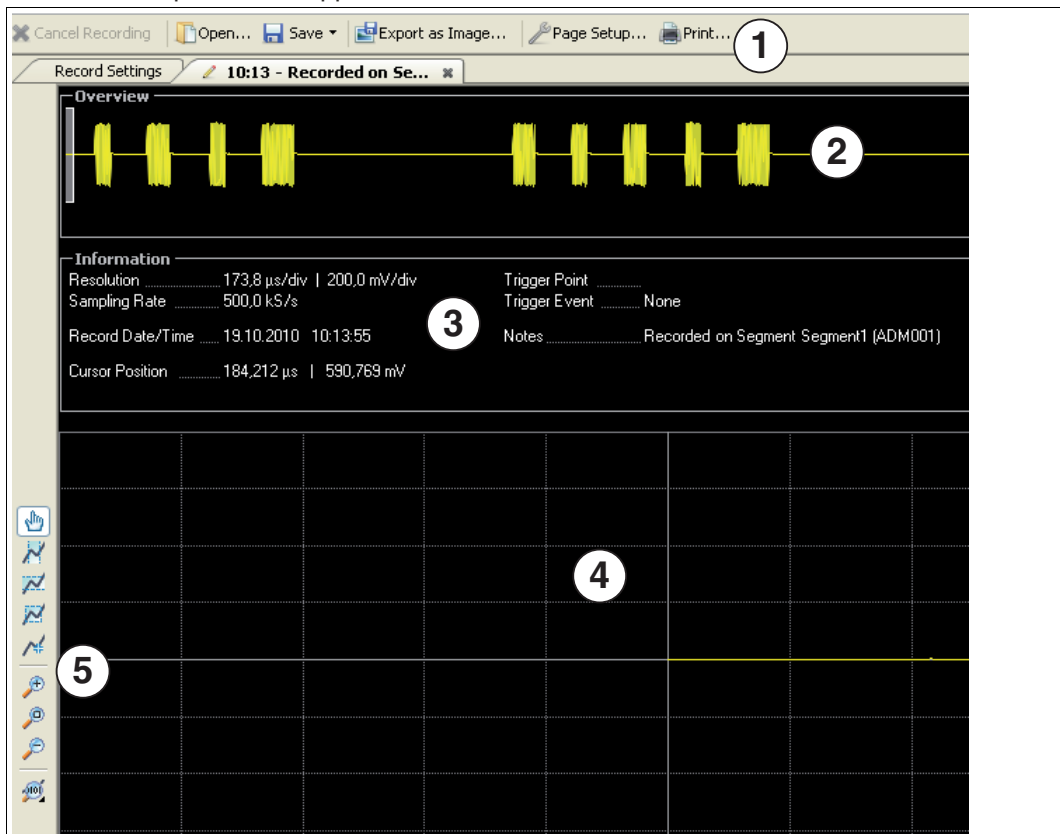

Figure 5.57 Oscilloscope screen overview

- 1 Record toolbar
- 2 Overview screen
- 3 Information and users note
- 4 Zoom in view
- 5 Oscilloscope toolbar

5.12.3 Trigger Description

To make sure that the triggered frame is valid, every trigger event occurs at the end of the frame.

Trigger Events for FOUNDATION Fieldbus

Name	Result
Pass Token to address	Trigger if the specified addresses send frames after receiving a pass token.
ProbeNode to address	Trigger if a probe node is sent to the specified address, but no probe node response is detected as the next frame.
Token usage from address	Trigger if the specified addresses send frames after receiving a pass token.
Missing Token usage from address (next valid bus address is triggered)	Trigger if a pass token is sent to the specified address, but is not used from this address afterwards.
Probe Response from address	Trigger if a probe node frame to the specified address is detected.
Missing Probe Node Response from address	Trigger if a probe node is sent to the specified address, but no probe node response is detected as the next frame.
Claim LAS from address	Trigger if a Claim LAS frame is detected from the specified address.
Transfer LAS to address	Trigger if a Transfer LAS frame to a specified address is detected.
Maintenance Required by address (available since diagnostic manager version 1.3)	Triggers when one of the parameters noise, jitter or signal level gets into state maintenance required. Note: Amplitude, recording length, and pre-trigger time are set automatically independent from the settings here.
Out of Specification by address (available since diagnostic manager version 1.3)	Triggers when one of the parameters noise, jitter or signal level gets into state out of specification. Note: Amplitude, recording length, and pre-trigger time are set automatically independent from the settings here.

Trigger Events for PROFIBUS PA

Name	Result
Request from address	Trigger if any request frame is detected from the specified address.
Response from address	Trigger if any response frame is detected from the specified address.
Missing Response from address (next valid bus address is triggered)	Trigger if the slave at the specified address does not respond on a request.
Pass Token to address	Trigger if a pass token frame to the specified address is detected.
Missing Pass Token response from address	Trigger if a master at the specified address does not react on a Pass Token frame.

Name	Result
Maintenance required by address (available since diagnostic manager version 1.3)	Triggers when one of the parameters noise, jitter or signal level gets into state maintenance required. Note: Amplitude, recording length, and pre-trigger time are set automatically independent from the settings here.
Out of Specification by address (available since diagnostic manager version 1.3)	Triggers when one of the parameters noise, jitter or signal level gets into state out of specification. Note: Amplitude, recording length, and pre-trigger time are set automatically independent from the settings here.

Note

The CRC values of the advanced diagnostic module and the host system can differ, depending on the fault tolerances.

Other Trigger Events







Name	Result
CRC error	Trigger if a fieldbus frame with a CRC error is detected.
Framing error	Trigger if a frame is invalid (e. g., SOF detected but EOF missing).
Signal level	Trigger if a voltage higher than the specified value is detected. Triggers exist for signals, noise, etc.

5.12.4 Toolbars and Shortcuts









Note

If you close the oscilloscope dialog, all unsaved recordings are lost.



Recording Toolbar

Button	Name	Result
	Cancel Recording	Cancel the current oscilloscope record.
	Open	Open a saved oscilloscope record.
	Save	Save oscilloscope record as XML-file.
	Export as Image	Save the current view of the oscilloscope graph as image. File types: png, jpeg, gif, bmp
	Page Setup	The page setup object contains all page setup attributes: Paper size, left margin, bottom margin and so on.
	Print	Print the current view of the oscilloscope graph.

Oscilloscope Toolbar

Button	Name	Result
	Move	Grip and move the graph. Press and hold the left mouse button.
	Horizontal marker	Measure the time difference. Press left mouse button to set the first marker and press the right mouse button to set the last marker.
	Vertical marker	Measure the voltage difference. Press the left mouse button to set the upper marker and press the right mouse button to set the lower marker.
	Rectangular marker	Measure time and voltage difference. Press and hold the left mouse button to set the rectangular marker.
	Marker measurement	Measure the time and voltage at one point.
	Zoom in	Enlarge the view of the graph.
	Scale 1:1	See 1:1 graph size.
	Zoom out	Reduce the view of the graph.
	Analysis	On/Off different view of the graph. Different Layers: 1-bit level, 1 section, 2 short, 2 full

Oscilloscope Shortcuts

Button	Shortcut	Result
	Drag while left mouse button is pressed	Move the waveform to the left/right.
	Double-click left mouse button	Sets the maximum cursor to the maximum value of the currently visible part of the waveform.
	Double-click right mouse button	Sets the minimum cursor to the minimum value of the currently visible part of the waveform.
All tools	Double-click on telegram in overview section	Shows the complete frame in detail/zoom-in view.
All tools	CTRL + mouse wheel	Increases/decreases the zoom factor.

5.13 Firmware Update

The firmware update function enables you to benefit from the latest software developments.

Firmware Update



Warning!

Connection Loss

In some situations, the advanced diagnostic module (ADM) disconnects during the update process. Do not try to reconnect manually. The ADM reconnects automatically after a short time.

Before you perform a firmware update, ensure that all diagnostic manager windows are closed and that the ADM is connected and online.

1. Right-click the **Advanced Diagnostic Module** in the project section and choose **Additional Functions > Firmware Update**.

↳ The firmware update window appears.

Firmware Update - Step 1 of 3
Please select firmware file and press 'Next' button to begin the firmware update.

Device Data

Product:

Software Revision:

Firmware File

Select firmware source: Use firmware provided with this DTM
 Use firmware file from disk

File Name:

File Type:

Product:

Firmware Version:

Figure 5.58 Firmware update tab

2. Choose **Check Device** in the device data section.

↳ The firmware file section displays the product description and the current firmware version of the selected device.

3. Select the firmware source in the **Firmware File** section.
4. Choose **Next**.
5. After the firmware has been updated successfully, choose **Close**.

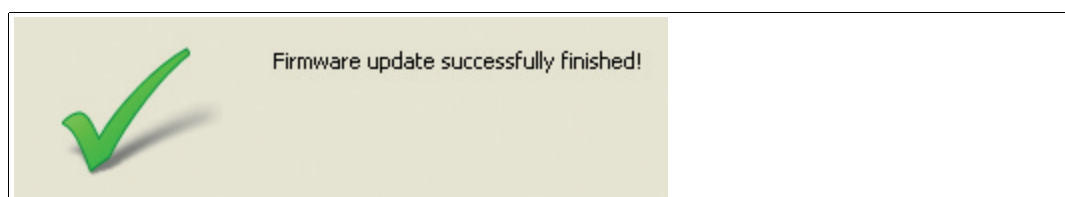

Figure 5.59 Firmware update successful

5.14 FDS Diagnostics

The FSD DTM offers a diagnostics view. This diagnostics gives an overview of all currently active alarms for the segments connected to the FDS, as well as the last time an alarm was active for a segment. With the **Open** button you can directly open the segment diagnostics view for the respective segment.

Device Name: FieldConnex Diagnostic Server
 Tag of the FDS: FDS
 Summary Alarm Status:

Filter entries: Show all Segments

Segment Tag	Path	Description	Last alarm time
Segment1	PORT001.ADM001.Segment1	No Error	01.01.1984 01:00:00
Segment2	PORT001.ADM001.Segment2	Maintenance Required	01.01.1984 01:00:00
Segment3	PORT001.ADM001.Segment3	No Error	01.01.1984 01:00:00
Segment4	PORT001.ADM001.Segment4	No Error	01.01.1984 01:00:00
Segment1	PORT001.ADM002.Segment1	No Error	01.01.1984 01:00:00
Segment2	PORT001.ADM002.Segment2	No Error	01.01.1984 01:00:00
Segment3	PORT001.ADM002.Segment3	No Error	01.01.1984 01:00:00
Segment4	PORT001.ADM002.Segment4	No Error	01.01.1984 01:00:00
Segment1	PORT001.ADM003.Segment1	No Error	01.01.1984 01:00:00
Segment2	PORT001.ADM003.Segment2	Segment Disabled	01.01.1984 01:00:00
Segment3	PORT001.ADM003.Segment3	No Error	01.01.1984 01:00:00
Segment4	PORT001.ADM003.Segment4	No Error	01.01.1984 01:00:00
Segment1	PORT001.ADM004.Segment1	No Error	01.01.1984 01:00:00
Segment2	PORT001.ADM004.Segment2	No Error	01.01.1984 01:00:00
Segment3	PORT001.ADM004.Segment3	No Error	01.01.1984 01:00:00
Segment4	PORT001.ADM004.Segment4	No Error	01.01.1984 01:00:00
Segment1	PORT002.ADM001.Segment1	No Error	01.01.1984 01:00:00
Segment2	PORT002.ADM001.Segment2	No Error	01.01.1984 01:00:00
Segment3	PORT002.ADM001.Segment3	No Error	01.01.1984 01:00:00
Segment4	PORT002.ADM001.Segment4	No Error	01.01.1984 01:00:00
Segment1	PORT002.ADM002.Segment1	No Error	01.01.1984 01:00:00
Segment2	PORT002.ADM002.Segment2	No Error	01.01.1984 01:00:00
Segment3	PORT002.ADM002.Segment3	No Error	01.01.1984 01:00:00
Segment4	PORT002.ADM002.Segment4	No Error	01.01.1984 01:00:00
Segment1	PORT002.ADM003.Segment1	Out of Specification	01.01.1984 01:00:00
Segment2	PORT002.ADM003.Segment2	No Error	01.01.1984 01:00:00
Segment3	PORT002.ADM003.Segment3	No Error	01.01.1984 01:00:00
Segment4	PORT002.ADM003.Segment4	No Error	01.01.1984 01:00:00

Close

It is also possible to filter the displayed segments to show only currently active alarms or to show segments with an active alarm during several periods of time. This is especially helpful if volt-free contact integration is used and you intend to check which segment generated the alarm.

Show all Segments

Show only current alarms

Show segments with an alarm during the last hour

Show segments with an alarm during the last 6 hours

Show segments with an alarm during the last day

Show segments with an alarm during the last week

Show segments with an alarm during the last month

Show segments with an alarm during the last year

5.15 FDS Reporting Wizard

The FDS reporting wizard allows creating reports of all segments connected to an FDS. Currently, one report type is supported:

- Surge protector status

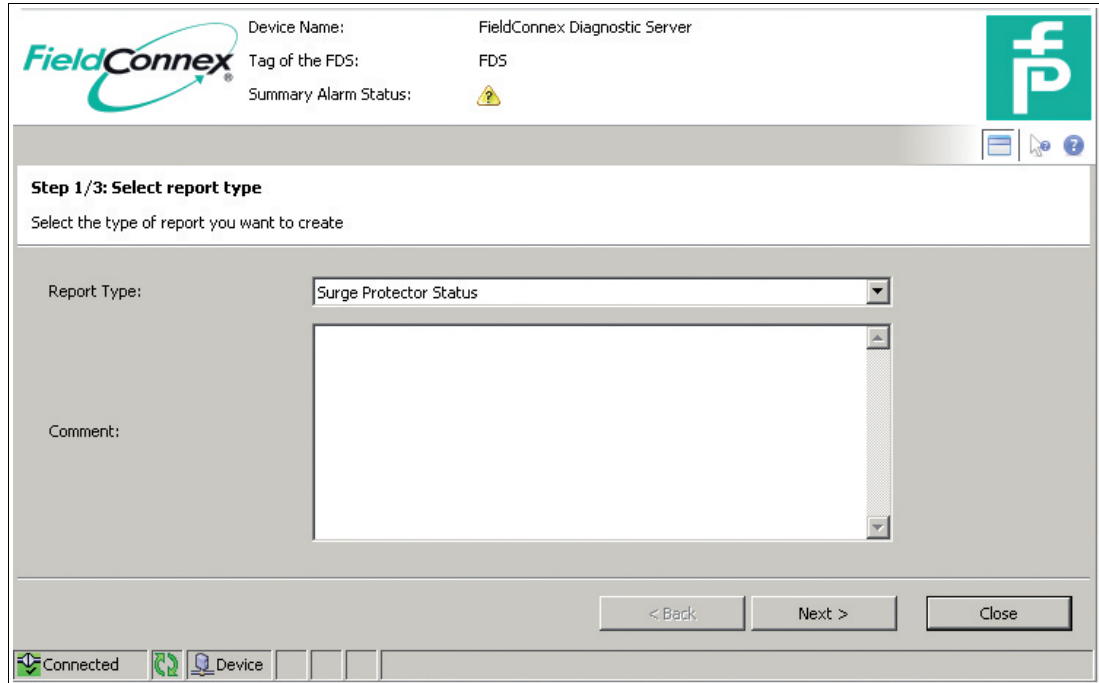

If you use FieldConnex® surge protectors with diagnostics, this report gives you an overview of all currently detected issues related to the surge protectors. It can be used to check the surge protectors after a surge incident.



Checking the Surge Protector Status

1. Start the reporting wizard.
2. Select the report type.
3. Optionally enter a comment to include into the report.
4. Click **Next**.

↳ The report is being generated.

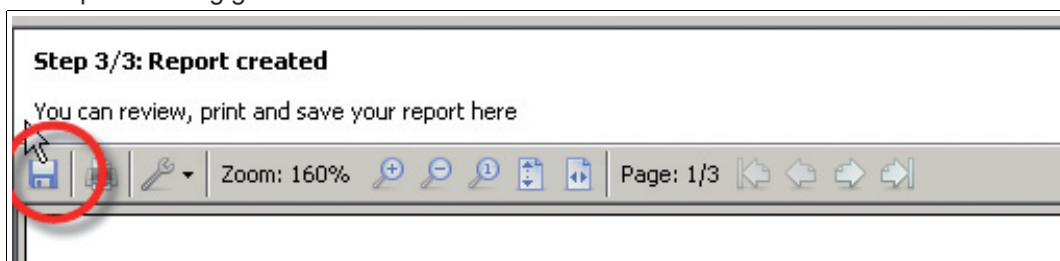

6 FOUNDATION Fieldbus Integration

The FOUNDATION Fieldbus integration is based on an FF-H1 field device inside the diagnostic gateway. These devices map the data of up to 16 HD2-DM-A modules to FOUNDATION Fieldbus data structure.

Both the measurement data and the expert system evaluations of the data are available inside the data structures of transducer blocks. Advanced diagnostic modules (ADM) alarms are sent to a process control system (PCS) using block alarms, field diagnostic alarms, or scheduled function block data.

Beside the DD for integration into the PCS, also a DTM is available providing a more comfortable access to the advanced physical layer diagnostic functionality and additional functions.

The FF-H1 field device supports up to 16 HD2-DM-A ADMs, with each providing 4 segments. This results in 64 segments supported by one diagnostic gateway in FF-H1 mode.

Each segment supports up to 18 FF-H1 field devices including the host(s).

Before reading this chapter, see chapter 2.

6.1 FF Device Structure

The device consists of the following function blocks:

- 1 resource block
- 16 ADM_TB transducer blocks: Each block corresponds to 1 ADM with 4 segments
- 1 IO_TB transducer blocks: The I/O functionality of the device is described in a separate chapter. See chapter 7
- 4 multiple digital input (MDI) function blocks
- 1 digital input (DI) function block
- 1 multiple analog input (MAI) function block only usable for IO_TB
- 1 multiple digital output (MDO) function block only usable for IO_TB

The following image shows a simplified device structure that only takes ADM_TB transducer blocks and the associated function blocks into account. For more information on the IO_TB and its corresponding function blocks, see chapter 7.

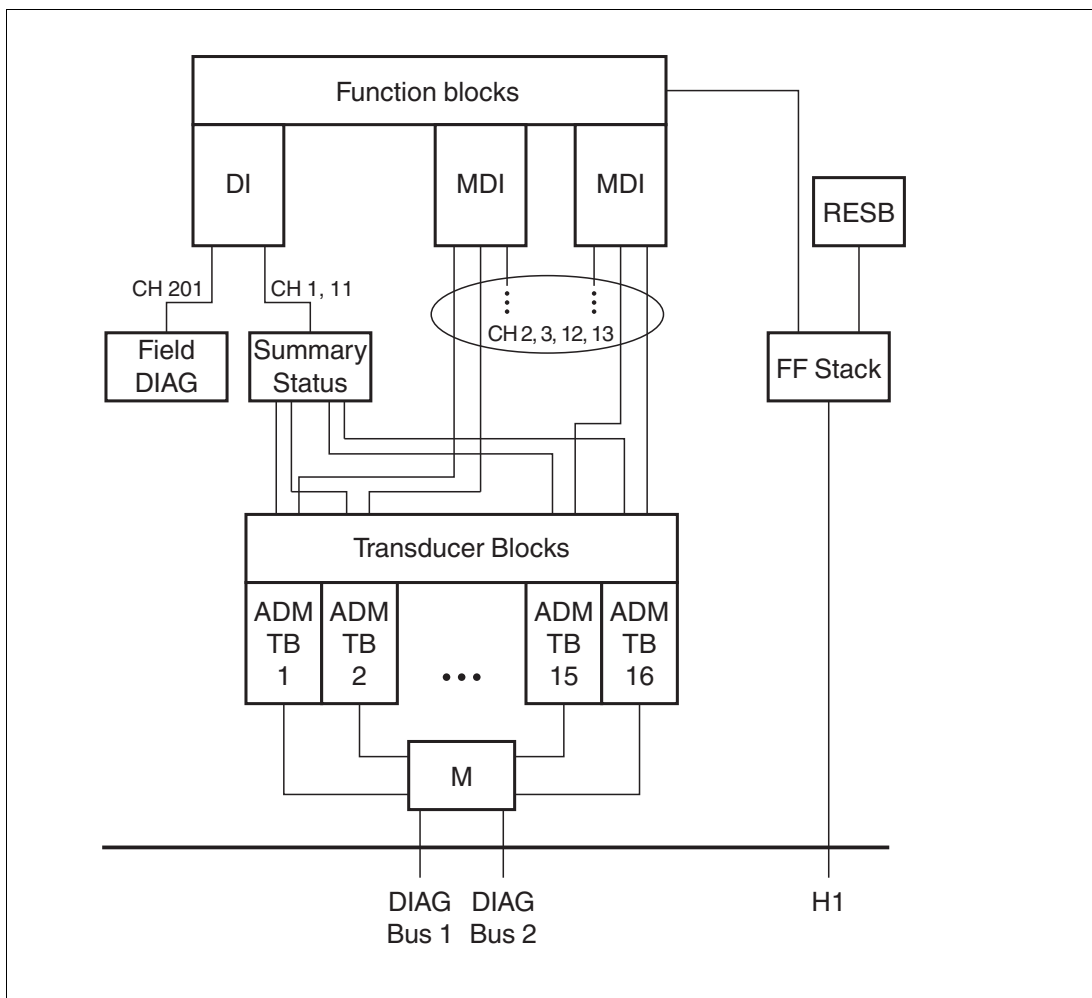

Device identification:

- Manufacturer ID: 502B46 (Pepperl+Fuchs)
- Device type: 0005 (HD2-GT-2AD.FF.IO)
- Default process data (PD) tag: P+F DGW-FF plus 8-times underscore plus 14-digit serial number
- Default node address: 248

ADM Mapping and Address Assignment

The diagnostic gateway FF-H1 field device contains 16 transducer blocks for ADMs. Each of these transducer blocks includes the 4 segments supported by an HD2-DM-A. The ADMs are mapped to the transducer blocks based on their address. The address is set using a DIP switch located on the module. See chapter 4.1.2.

ADM Address/Transducer Block Number	Default Tag	Service Data (OD) Index
1	ADM_TB_1 serial number	500
2	ADM_TB_2 serial number	600
3	ADM_TB_3 serial number	700
4	ADM_TB_4 serial number	800
5	ADM_TB_5 serial number	900
6	ADM_TB_6 serial number	1000

2020-11

ADM Address/Transducer Block Number	Default Tag	Service Data (OD) Index
7	ADM_TB_7 serial number	1100
8	ADM_TB_8 serial number	1200
9	ADM_TB_9 serial number	1300
10	ADM_TB_10 serial number	1400
11	ADM_TB_11 serial number	1500
12	ADM_TB_12 serial number	1600
13	ADM_TB_13 serial number	1700
14	ADM_TB_14 serial number	1800
15	ADM_TB_15 serial number	1900
16	ADM_TB_16 serial number	2000



Note

The devices can be connected to any of the 2 diagnostic bus channels. For best performance connect the same number of HD2-DM-A to each diagnostic bus channel.

6.2

Installation

Typically, the FF-H1 field device built into the diagnostic gateway is connected to the host of a PCS, using FF-H1 as every other FF-H1 field device. For more information on the installation and the related terminals, see chapter 4.



Note

It is recommended to connect all DGW-FF devices in your application to a specific FF segment(s) diagnostics to clearly separate the diagnostics from the actual process functionality.

It is recommended that the diagnostic segments provide a high amount of free communication time to allow an efficient use of the advanced diagnostic data.

Beside the main connection using FF-H1 there are 2 more options if the DTM is used:

- FF-H1 for basic communication and Ethernet for advanced communication
- FF-H1-over-Ethernet connection

FF-H1 for Basic Communication and Ethernet for Advanced Communication

The FieldConnex[®] advanced physical layer diagnostics features "history report" and "fieldbus oscilloscope" require large amounts of data transferred to the DTM. Since FF-H1 is not suitable for transferring this amount of data, the DTM uses TCP/IP communication. There is no configuration required to support this functionality. If you connect Ethernet to the diagnostic gateway in addition to FF-H1, the DGW-FF DTM automatically detects and uses Ethernet for the history and oscilloscope data. All other data is communicated using FF-H1.

If a firewall is used between the PC running the DGW-FF DTM and the diagnostic gateway, the TCP/IP ports 25 063 and 25 064 must be allowed for communication.

FF-H1-over-Ethernet Connection

During commissioning of a plant, the host may not be available yet, but commissioning of the physical layer is already being executed. For these use cases, a PC (e.g., laptop) can be connected to the diagnostic gateway using Ethernet. Alternatively, Ethernet communication can be used since the communication performance is much higher. The DGW-FF DTM can be connected to a special communication DTM included in the same installation package. This communication DTM transfers the FF-H1 communication over Ethernet and allows the DGW-FF DTM to provide the same functionality as via FF-H1. Typically, a stand-alone FDT frame like PACTware™ is used for this setup. For more information, see chapter 6.7.

After the commissioning, you can upload the configuration data to your PCS with FF-H1. Commissioning reports can be transferred to a DTM inside the PCS by exporting and importing reports.

6.3 Alarm Integration

Advanced diagnostic module (ADM) alarms are sent to a process control system (PCS) with block alarms, field diagnostic alarms, or scheduled function block data.

6.3.1 Alarm Integration with Scheduled Function Block Data

The status of ADMs can be transferred in different ways using scheduled communication:

- **Summary status:** This is a summary of the status for all ADMs connected to the DGW-FF.
- **ADM status:** A single status value for each of the ADMs (4 segments).
- **Field diagnostic value:** The currently worst active status of field diagnostic is transferred as an enumeration using a digital input (DI) function block.

Each of these 3 methods can transfer binary information (alarm - no alarm) or an enumeration showing more details (no error, maintenance required, out of specification, etc.)

Summary Status for all ADMs (DI Function Block)

Add DGW-FF digital input (DI) function block to your schedule.

Channels:

- **Binary Status all ADMs (Channel 1):** Value is 0 (no error) or 1 (other status). "1" means any segment or system on an ADM_TB in AUTO mode has a status other than "no error", "excellent", "good" or "segment disabled".
- **Enum Status all ADMs (Channel 11):** Worst status for all systems and segments of ADM_TBs in AUTO mode. The value uses the following encoding:

Value	Description
00h	No error (segment commissioned)
01h	Maintenance required (segment commissioned)
02h	Out of specification (segment commissioned)
10h	Excellent (segment non-commissioned)
11h	Good (segment non-commissioned)
12h	Out of specification (segment non-commissioned)
20h	Fail (ADM hardware error)
21h	Configuration error (of an ADM transducer block)
22h	No ADM connected

ADM Status (MDI Function Blocks)

Add 1 or 2 DGW-FF multiple digital input (MDI) function blocks to your schedule. If you use 1 ... 8 ADMs, 1 MDI is sufficient. If you use 9 ... 16 ADMs, 2 MDI function blocks are required.

Channels:

- **Binary Status ADM x-y (Channel 2, 3):** Value is 0 (no error) or 1 (other status). "1" means any segment or system on the related ADM has a status other than "no error", "excellent", "good" or "segment disabled".
- **Enum Status ADM x-y (Channel 12, 13):** Worst status for all systems and segments of ADM_TBs in AUTO mode. The encoding is the same as for the enum status of all ADMs listed above.

Channel 2 and 12 correspond to ADM_TB 1 ... 8, channel 3 and 13 correspond to ADM_TB 9 ... 16.

Field Diagnostic Value (DI Function Block)

Add DGW-FF digital input (DI) function block to your schedule.

Channel:

Field Diagnostics (Channel 201): The current worst active status of field diagnostics is transferred as an enumeration using a DI. The data the field diagnostic status is built from can be configured at the resource block and may also include other diagnosis information in addition to the ADM information. The value uses the following encoding:

Value	Description
00h	No error
30h	Check function
01h	Maintenance required
02h	Out of specification
20h	Fail

6.3.2 Field Diagnostics

The FF-H1 field device built in the DGW-FF supports field diagnostics according to FF-912. This also includes alarm information from the ADMs. For more information, see chapter 8.4.

6.3.3 Transducer Block Alarms

The ADM transducer blocks support block alarms. If the status of any segment shows an error, i.e., if the XD status is not "Good", "Excellent" or "No error", a block alarm with a BLOCK_ERR value of the other is activated.

6.4 Operation with Device Descriptions (DD)

The DGW-FF supports the following Device Description Languages (DDL): DD4, and EDDL (Electronic Device Description Language, also DD5). DD4 only supports a reduced set of features compared to EDDL. Therefore, it is recommended to use EDDL if your process control system (PCS) supports this option. The differences are explained in the following chapters. For more information on all parameters supported by the FF-H1 field device, see chapter 8.2.

EDDL (DD5) contains 2 sets of menus for the use cases configuration and diagnostics. The configuration menu contains all parameters necessary to configure the maintenance limits. The diagnostics menu provides an overview of the actual measured values and diagnosis information.

6.4.1 Configuration

It is recommended to use the commissioning wizard for configuration of the segment, since this is the fastest and safest way of adjusting the maintenance limits. However, it is also possible to configure a segment manually; all necessary settings are available as FF parameters. For systems that do not support all EDDL (DD5) features, a list of parameters of the ADM_TB is available. See chapter 8.2.1

System

- Block tag: Block tag of the ADM_TB.
- History period: Time difference between non-volatile storage of segment measurement entry. These entries can only be read using the history export function. See chapter 5.11
- Identify diagnostic module: Causes LEDs of diagnostic module to flash.
- ADM firmware update: Updates the advanced diagnostic module (ADM) to the firmware built into the HD2-GT-2AD.FF.IO device. Only 1 ADM can be updated at a time. Check the expert diagnostic messages in the diagnostic segment user interfaces for the update status.

Segment

- Segment tag: Tag of the segment. Should be set to the same tag as the physical segment for reference.
- Segment mode: Select the segment mode. For more information on the segment mode, see chapter 2.
 - Disabled: Segment is not used.
 - Non-commissioned: Segment operates in non-commissioned mode.
 - Commissioned: Segment operates in commissioned mode.
- Power supply real-time monitoring: Enables or disables real-time monitoring of power supplies. When checked, an alarm is generated when a power supply module is not inserted or not working correctly. This setting is effective in commissioned mode only.
- Trunk surge protector alarm: When enabled, trunk surge protector alarms are monitored. This setting is effective in commissioned mode only.
- Segment X commissioning button-method: Starts commissioning wizard. See chapter 6.5.1
- Segment X commissioning (simple-mode-) method: Starts a simple commissioning method. This approach is useful for hosts that do not support the necessary EDDL features for the full-blown commissioning wizard.
- Segment X tag import (simple-mode-) method: Starts a simple tag import method. This approach is useful for hosts that do not support the necessary EDDL features for the full-blown commissioning wizard.

Topology

Topology information is used in non-commissioned mode to refine diagnostics. The quality of the expert system messages is improved if the topology of the segment is known.

Configuration grid

The configuration grid provides the possibility to change the maintenance-required limits of several segment parameters and to enable or disable monitoring of out-of-specification limits. All settings on this page are effective in commissioned mode only. A value of "0" disables real-time monitoring of the limits.

- Voltage: Segment voltage limits
- Current: Segment current consumption
- Unbalance: Segment unbalance against positive or negative pole
- Noise: Segment noise level

- Jitter: Maximum field device jitter value on the segment
- Minimum signal: Lowest field device signal level on the segment
- Maximum signal level: Highest field device signal level on the segment

Field Devices

This page allows the configuration of limits and information about the field devices attached to the segment. All devices detected on the fieldbus that are not available in this list are unconfigured field devices.

- Address: When address is “0”, the entry is not used.
- Tag: Field device tag. It is recommended to use the tag import wizard, included in the commissioning wizard, see chapter 6.5.1 for automatic tag reading from field devices.
- Signal level maintenance required limits: When limit is set to “0”, the limit is not supervised.
- Signal level out of specification limits: Can be enabled and disabled. When limit is set to “0”, the limit is not supervised.
- Coupler Alarms maintenance required or out of specification: When device couplers with diagnostics are used, the alarms can be enabled and disabled.

6.4.2 Configuration Limitations

The configuration parameters have the following limitations that result in a configuration block error:

- Maximum segment voltage > (minimum segment voltage + 1.6 V)
- Maximum segment current > (minimum segment current + 40 mA)
- Maximum segment unbalance > (minimum segment unbalance + 40%)
- Address of all configured nodes must be unique



Note

In case of a configuration block error, check the expert system messages for information on which error is causing the problem.

6.4.3 Diagnostics

The diagnostic user interfaces show the currently measured values of system and segment, as well as the expert system messages for simplified diagnostics and remedy of potential problems.

System

- Block tag: Tag of the ADM_TB.
- Serial number: Serial number of connected HD2-DM-A module.
- Software revision: Software revision of connected HD2-DM-A module.
- Motherboard type: Motherboard the module is mounted on.
- Bulk power supply: Currently measured value and out-of-specification limits.
- ADM diagnostics: Overview of system and all segment states.
- Identify diagnostic module method: When clicked, the LEDs of the connected ADM start flashing.
- System alarms: Bulk power supply diagnostics, high/low out-of-specification for the primary and secondary power supply.

Segment

Overview

- Segment tag: Tag of the segment
- Segment mode: Current segment mode (disabled, non-commissioned, commissioned)
- Segment status: Overall segment diagnostics quality
- Active diagnostics: Expert system messages about the current status of the segment. The message describes the phenomenon detected on the fieldbus. Every expert system message has a unique number assigned. For more information on the causes of any detected phenomenon as well as actions to solve the found issues, .

Statistics

- Communication active: Indicates whether communication is detected on the segment
- Number of field devices: The total number of active field devices on the segment
- Error rate in actual history period: Percentage of broken telegrams in current history period
- Error rate in last history period: Percentage of broken telegrams in last history period. History period length is configurable on system configuration page.

List of current segment measurements

- Voltage: Segment voltage
- Current: Segment current consumption
- Unbalance: Segment unbalance to positive or negative pole
- Noise: Segment noise
- Jitter: Maximum field device jitter
- Minimum signal level: Minimum field device signal level
- Maximum signal level: Maximum field device signal level

Diagnosis

- Segment alarms: List of segment alarms (valid when segment is running in commissioned mode)
- Segment quality: List of segment quality analysis (valid when segment is in non-commissioned mode)

Field Devices

The list “configured field devices” shows the current measured values of all configured field devices. You can see the current signal and jitter levels and the device status.

The “Unconfigured field devices” list shows all currently active unconfigured field devices and their measurement data.

6.5 Supported Methods

6.5.1 Commissioning Wizard



Note

It is strongly recommended to perform a commissioning run for each segment once all the installation work is completed.

The EDDL user interface provides a wizard to execute commissioning on a system. It consists of the following steps:

1. Welcome page

2. Topology information: Using the topology information that can be entered here, the expert system can refine its diagnostics of the current segment measurement information. This is useful in step 4.
3. Field device tagging: In this step, tags for the field devices can be assigned in either of the following 2 ways:
 - Entering tags manually in a grid.
 - Using a tag import wizard: The tag import wizard can import the tags of most devices on the segment automatically. This method is used most often except for the host itself. In order to use this wizard, it is necessary to disconnect the host from and reconnect the host to the affected segment. Follow the instructions of the wizard.
4. Show actual segment diagnostics based on topology information provided in step 2. This is the last possibility make any corrections on the segment before the actual commissioning run. Ensure that all problems on the segment are fixed before proceeding with next step of the wizard.
5. The actual commissioning is running automatically and takes several seconds to collect enough measurement data. The commissioning wizard configures the alarm limits automatically based on the measured data.
6. Presentation of commissioning result. You can review and edit the adjustments of the maintenance limits that the commissioning algorithm set automatically. The segment is now running in commissioned mode.

Segment Commissioning (Simple Mode)

Method also supported by DD4. Only step 5 of the commissioning wizard is executed.

Segment Tag Import (Simple Mode)

Method also supported by DD4. This method can import the tags of most devices on the segment automatically. This method is used most often except for the host itself. In order to use this wizard, it is necessary to disconnect the host from and reconnect the host to the affected segment. Follow the instructions of the wizard.

Identify Diagnostic Module (Flash LEDs)

Method also supported by DD4. This method causes the HD2-DM-A module to have all LEDs flashing for identification purpose.

ADM Firmware Update

The DGW-FF has an ADM firmware built in. This method can be used to update an ADM to any firmware compatible with the DGW-FF.

6.6 Installation of DGW-FF Device Type Managers with PACTware™



Installing DGW-FF Device Type Managers with PACTware™

Ensure you downloaded the software bundle that includes the DGW-FF device type manager (DTM) and all its tools and accessories, e.g., PACTware™, and the diagnostic gateway configuration tool from www.pepperl-fuchs.com. In order to install the FieldConnex® DGW-FF DTMs, proceed as follows:

1. Extract the software bundle to a local directory.
2. Go to the directory that includes the extracted files and run **autorun.exe** to start the installation wizard.
3. Select the software components you want to install and choose **Install selected application(s)**.
We recommend that you install all components.

4. In order to install the Microsoft® .NET framework, follow the instructions of the installation dialog.
5. In order to install PACTware™, follow the instructions of the installation dialog.
6. In order to install the FieldConnex DGW-FF DTMs, follow the instructions of the installation dialog.
7. After the selected components have been installed, choose **Quit** to leave the installation wizard.
↳ The DGW-FF DTMs and PACTware™ are now installed.
8. Run the FieldConnex diagnostic gateway DTM.
9. Choose **View > Device catalog**.
10. Choose **Update device catalog** in the device catalog section.

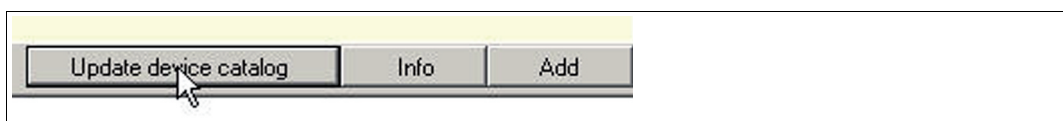

Figure 6.1 Update device catalog

11. Choose **Yes** to create a new PACTware™ device catalog.
12. Choose **OK**.
13. Choose **File > Exit** to quit PACTware™.

↳ PACTware™ is ready for use.

Licensing

In order to activate the full-featured version, a license key is needed. The license key is printed on the license certificate you have optionally received with the FieldConnex diagnostic manager software package. If you have downloaded the FieldConnex diagnostic manager from the internet, a license key can be ordered through your local Pepperl+Fuchs representative.

Note

Upgrade Information

After upgrading from diagnostic manager version 1.x to version 2.x, activate the new version with the upgrade license key. After complete reinstallation of the diagnostic manager, e.g., the installation on a new PC, enter both license keys from version 1.x and 2.x, one after the other, into the license activation tool.



License Activation

Before entering the license key, ensure that the diagnostic manager is closed.

1. Choose **Start > Programs > Pepperl+Fuchs > Activation Tool** to start the Pepperl+Fuchs license activation tool.

↳ The license activation tool window appears.

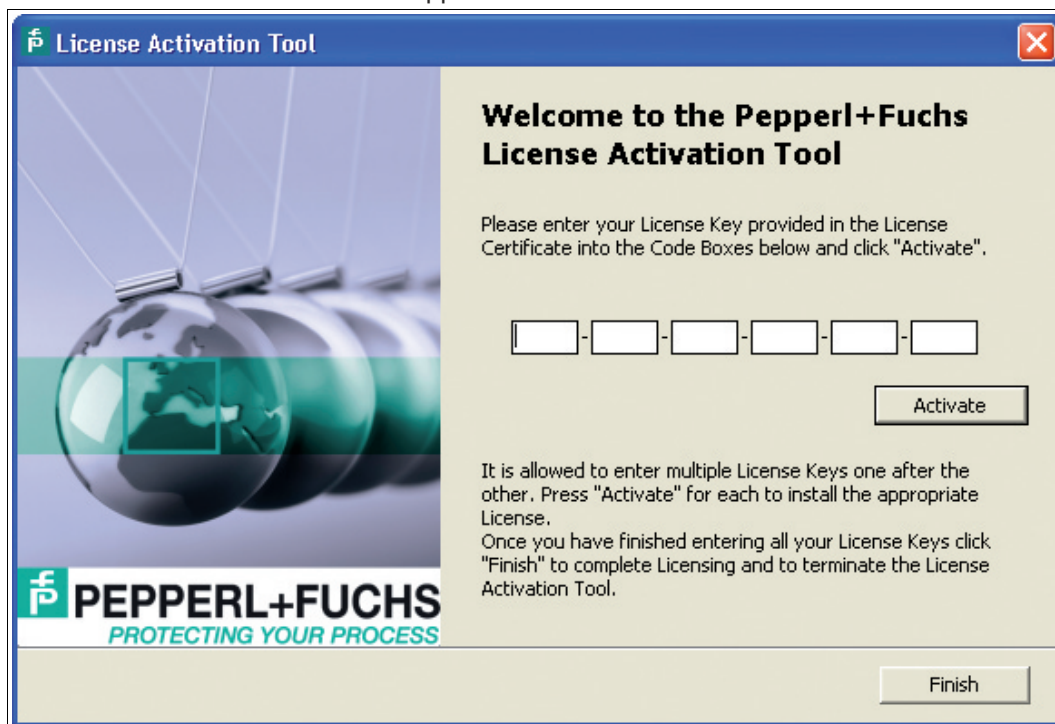

Figure 6.2 License activation tool

2. Enter your license key.
3. Choose **Activate**.
4. After the activation has been confirmed, choose **Finish**.

6.7 Project Setup

The DGW-FF DTM for the HD2-GT-2AD.FF.IO can be used in 2 different project structures:

Use the FF-H1 Communication DTM

The HD2-GT-2AD.FF.IO DTM can be connected to any FF-H1 communication DTM and FF-H1 communication channel of your PCS. The communication to the device takes place using FF-H1. Refer to the documentation of your field device tool (FDT) frame on how to connect the HD2-GT-2AD.FF.IO DTM to an FF-H1 communication channel.

Use the HD2-GT-2AD.FF.IO Communication DTM

During commissioning of a plant, the host may not be available yet, but the physical layer must already be commissioned. For such use cases, a PC, e.g., a laptop, can be connected to the diagnostic gateway via Ethernet. Alternatively, Ethernet communication with a much higher communication performance can be used. The DGW-FF DTM can be connected to a special communication DTM included in the same installation package. This communication DTM transfers the FOUNDATION Fieldbus H1 communication over Ethernet and allows the DGW-FF DTM to provide the same functionality as via FOUNDATION Fieldbus H1. Typically, a stand-alone FDT frame, e.g., PACTware™ is used for this setup.

6.8 HD2-GT-2AD.FF.IO Device Type Manager (DTM)

The DTM provides the following functions:

Online parameterization See chapter 6.8.1	This interface enables detailed access to all possible settings of the HD2-DM-A. It is for advanced parameterization and can be used to adjust the HD2-DM-A to some more seldom use cases not covered by the automatic tools like the commissioning wizard.
Commissioning wizard See chapter 6.8.2	The commissioning wizard is a tool for fast and easy system setup with ADM. It guides you through the entire setup process with system and segment calculation.
Diagnostics See chapter 6.8.3	The diagnostics function displays all alarms that have occurred at a glance.
Measured values See chapter 6.8.4	This function enables fast validation of a new or reworked fieldbus installation. It displays a qualitative rating of the relevant segment and field device data. In order to save the results as a report, this function enables you to create a snapshot of the measured values.
Snapshot explorer See chapter 6.8.7	The snapshot explorer simplifies administration and enables printing of existing snapshots and reports.
Parameterization See chapter 6.8.1	This is an offline interface, which means that you can change these settings without having a direct connection to the diagnostic device. This interface enables you to define the power supply, the alarm settings, and the field devices per segment.
History export See chapter 6.8.6	Allows exporting the history data automatically record by the HD2-DM-A.
Fieldbus oscilloscope See chapter 6.8.8	The fieldbus oscilloscope is the perfect tool for in-depth analysis of the fieldbus signal.
Tag import wizard See chapter 6.8.9	This wizard provides the option to import segment and device tags from the PCS to the DGW-FF.
Reporting wizard See chapter 6.8.10	Generates overview Reports for all segments connected to the diagnostic gateway.

6.8.1 Online Parameterization and Parameterization

The online parameterization and parameterization provide detailed access to all settings of the FF diagnostic gateway. It is typically used for detailed tuning of the ADM functionality, configuration of the I/O functionality and access to the resource and function blocks. For easy and fast configuration of the ADM functionality, it is recommended to use more advanced tools such as the commissioning wizard.

On the initial page, the online parameterization shows an overview of all function blocks.

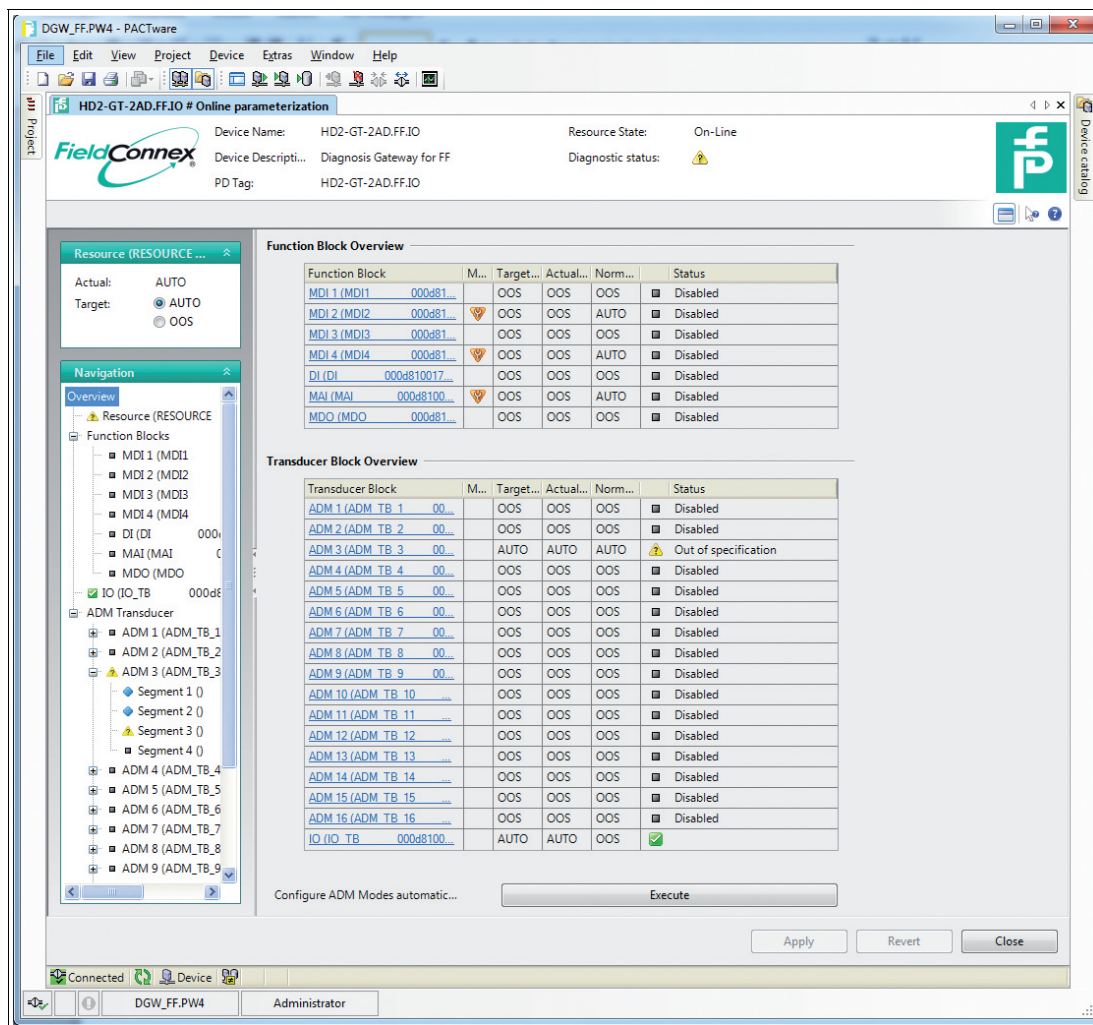

The overview also shows if the actual mode of a block is not equal to the normal mode. All unused blocks, e.g., unused function blocks, or ADM transducer blocks with no ADM connected, are usually set to out-of-specification (OOS) in order to exclude them from any summary diagnostics. For the ADM transducer blocks, this can be done automatically:



Excluding All Unused ADM Transducer Blocks from Summary Diagnostics

In order to configure the modes of all ADM transducer blocks automatically, click on **Execute** at the "Configure ADM Modes automatically" command.

↳ All blocks where a corresponding ADM is connected are set to normal and target mode "AUTO". All other blocks are set to normal and target mode "OOS".

If any other block of the device is selected in the navigation tree, all available configuration settings are shown on the right-hand side. For more information on parameters, see chapter 8.2.

6.8.2 Commissioning Wizard

The commissioning wizard is the recommended way to perform segment commissioning. The wizard guides you through all necessary steps to set tags of field devices and debug the segment. A report containing all segment measurements is generated to document the segment state at the time of commissioning run.



Commissioning Segments

1. Start the commissioning wizard.

↳ An overview is shown with information on which segments are not commissioned yet:

The screenshot shows the 'Commissioning Wizard' window for device 'HD2-GT-2AD.FF.IO'. The 'Device Navigation' pane on the left shows a tree structure under 'ADM Transducer' with 15 sub-items. The 'Commissioned Overview' pane on the right displays a table with the following data:

ADM Tag	Segment Tag	Status
ADM 1 (ADM_TB_1 00...	Segment 1 0	Commissioned mode
	Segment 2 0	Disabled
	Segment 3 0	Non commissioned mode
	Segment 4 0	Disabled
ADM 2 (ADM_TB_2 00...	Segment 1 0	Non commissioned mode
	Segment 2 0	Non commissioned mode
	Segment 3 0	Non commissioned mode
	Segment 4 0	Non commissioned mode
ADM 3 (ADM_TB_3 00...	Segment 1 0	Non commissioned mode
	Segment 2 0	Commissioned mode
	Segment 3 0	Non commissioned mode
	Segment 4 0	Disabled
ADM 4 (ADM_TB_4 00...	Segment 1 0	Non commissioned mode
	Segment 2 0	Non commissioned mode
	Segment 3 0	Non commissioned mode
	Segment 4 0	Non commissioned mode
ADM 5 (ADM_TB_5 00...	Segment 1 0	Non commissioned mode
	Segment 2 0	Non commissioned mode

2. In order to start commissioning, select a segment.

↳ The segment topology window appears:

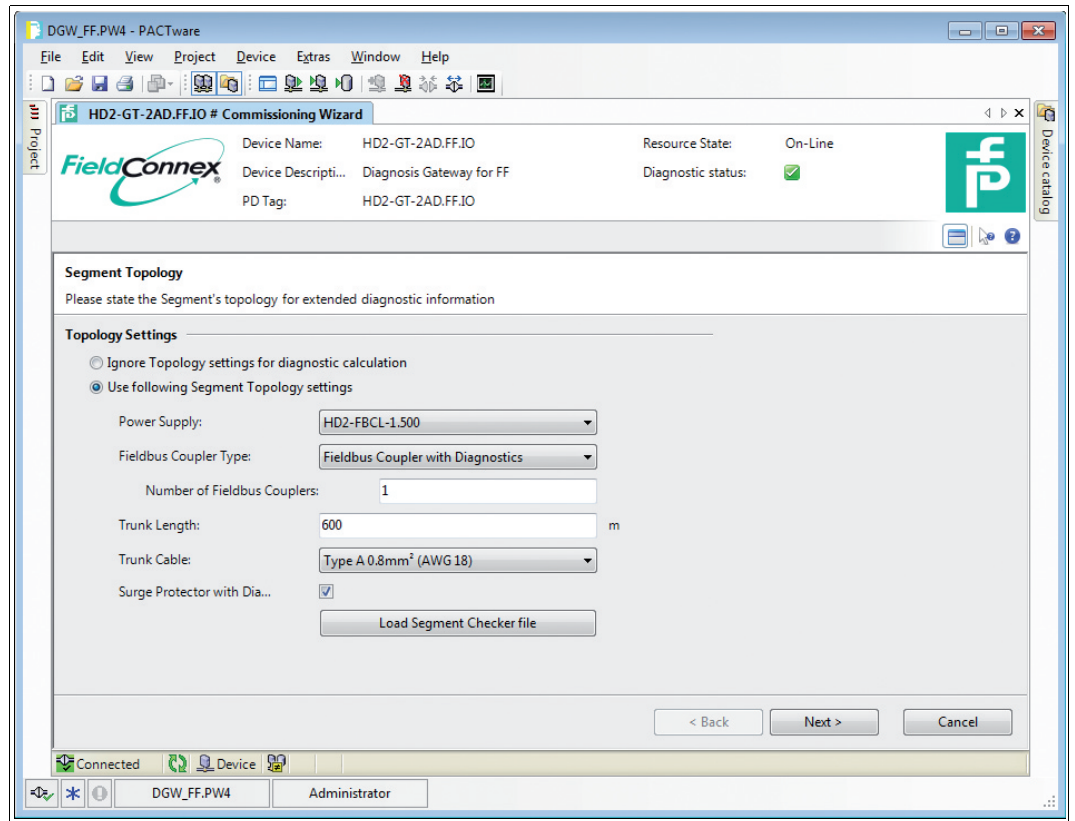

3. Enter segment topology settings to refine the diagnostics of the segment you intend to commission.
4. Click **Next**.

↳ The field device tags window appears:

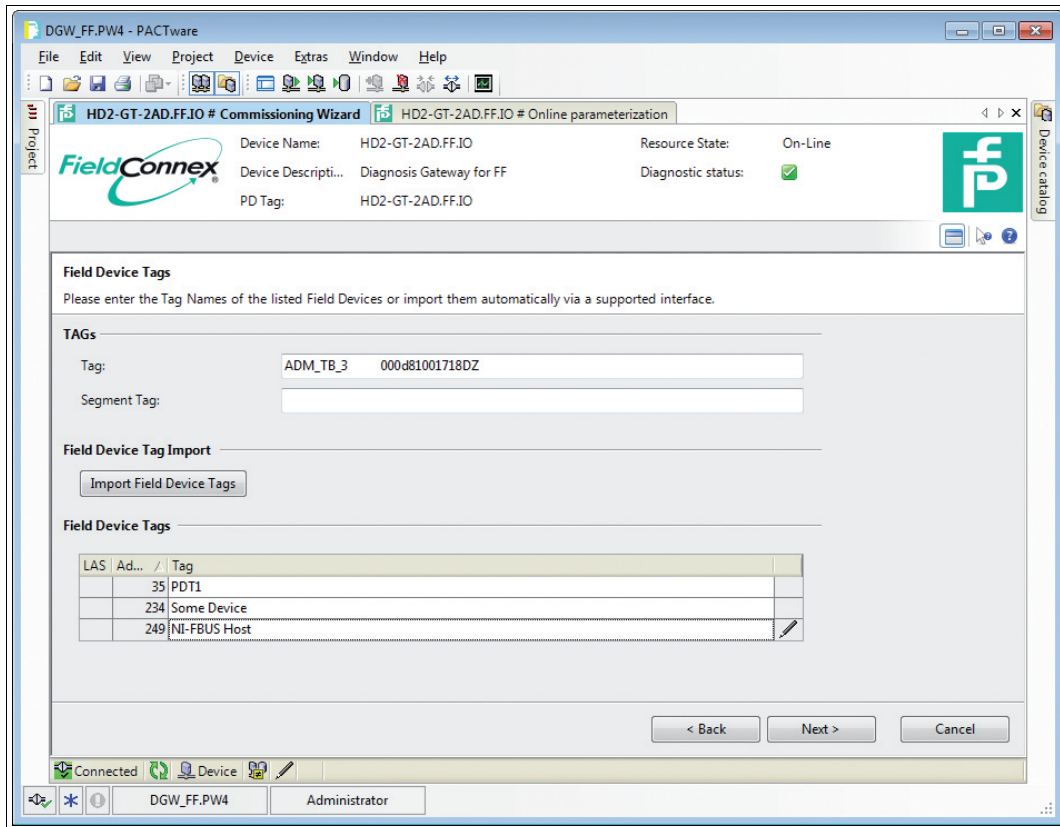

5. Enter field device tags manually or click **Import Field Device Tags**.

↳ Selecting **Import Field Device Tags** initiates the reading of the field device tags by observing the communication on the segment. In order to import segment and device tags from the process control system (PCS), use the Tag Import Wizard instead. See chapter 6.8.9.

6. Upon selecting **Import Field Device Tags**, follow the instructions of the window that opens:

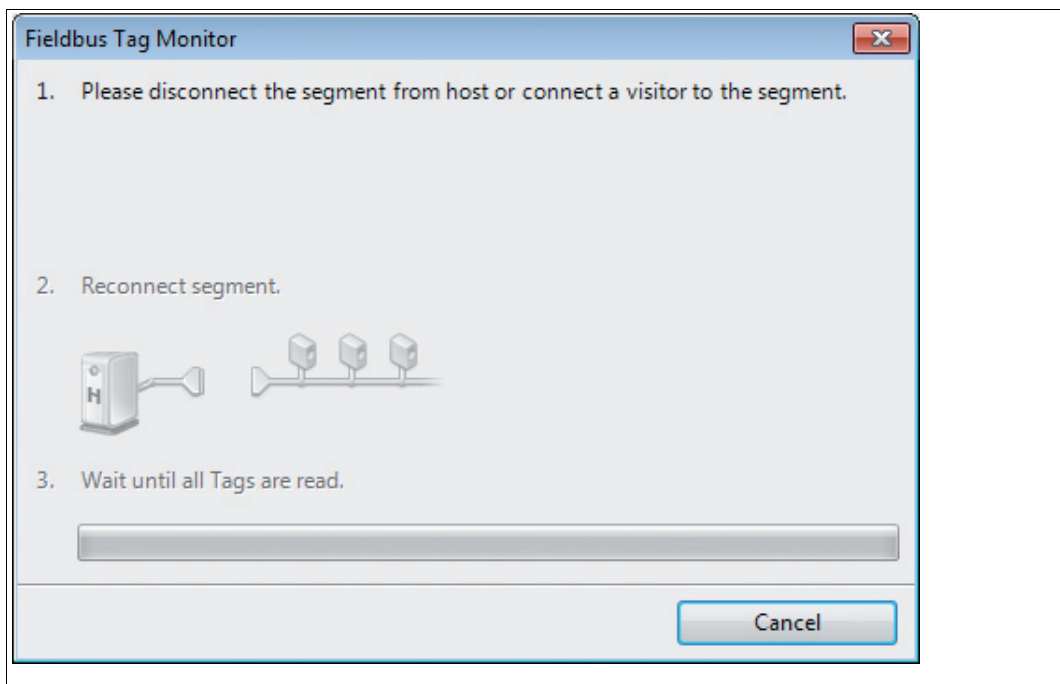

2020-11

7. Click **Next**.

↳ The diagnostic data overview window appears. It provides basic diagnostics of the segment measurements based on the topology information provided in the topology settings window:

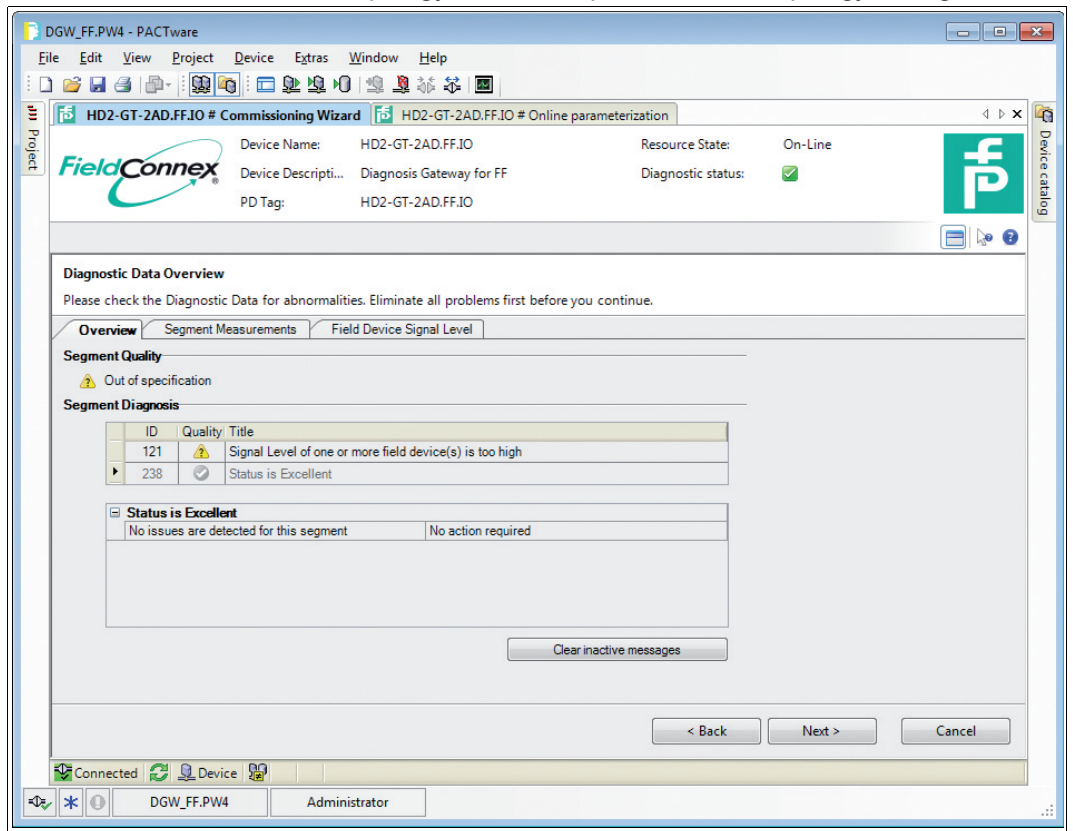

8. Eliminate possible problems by using the information given in the segment diagnostics table.

9. To start the commissioning, click **Next**.

↳ The commissioning wizard records physical layer data to create a snapshot of the current segment state. This may take a few seconds. After recording the result is displayed:

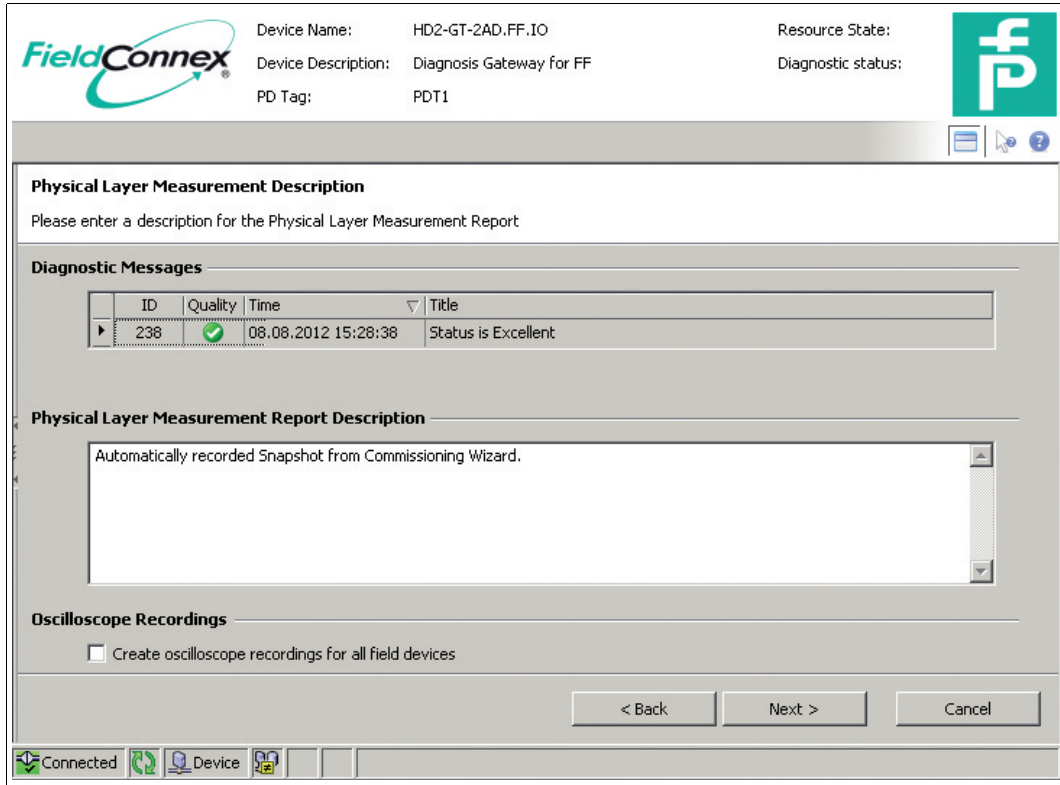

10. Enter a report description. You may also select the option to include characteristic oscilloscope recording fragments for each field device into the report.
↳ The actual snapshot report is shown. The report is stored in the DTM persistence and can be reviewed or printed anytime later in the snapshot explorer.

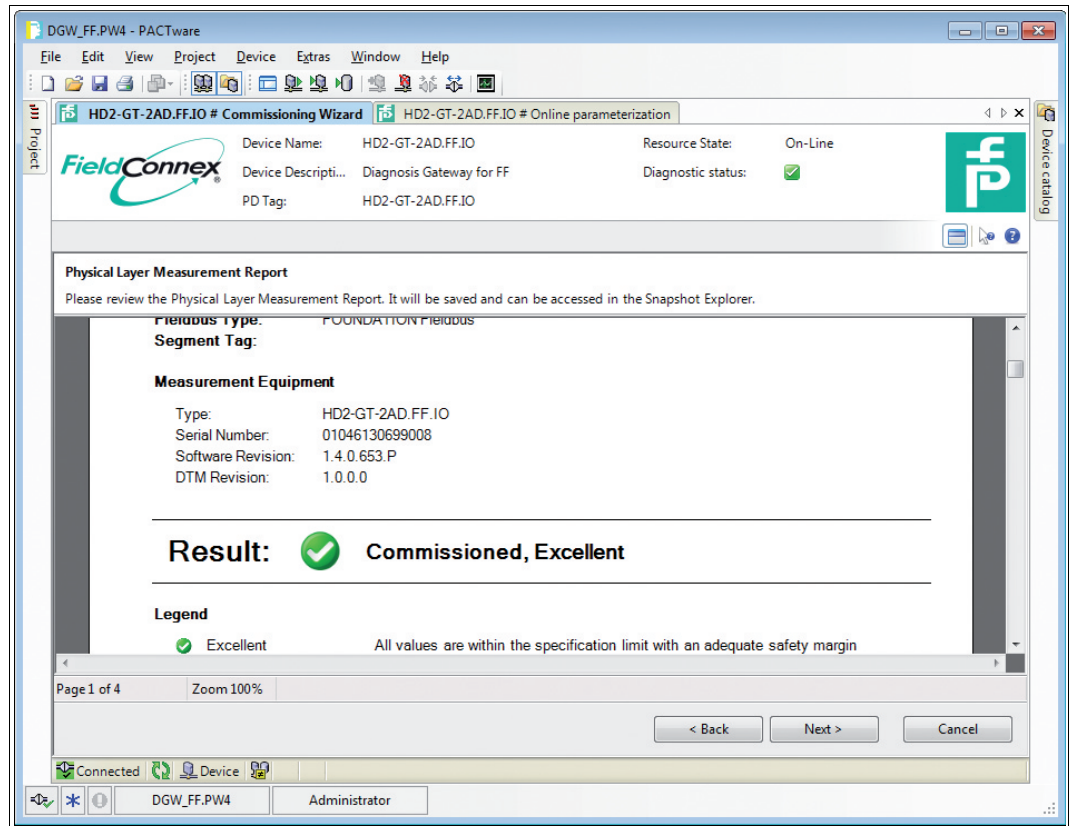

11. Click **Next**.

↳ The advanced diagnostic module's configuration window appears. Based on the snapshot report, maintenance required limits for all measured values are calculated.

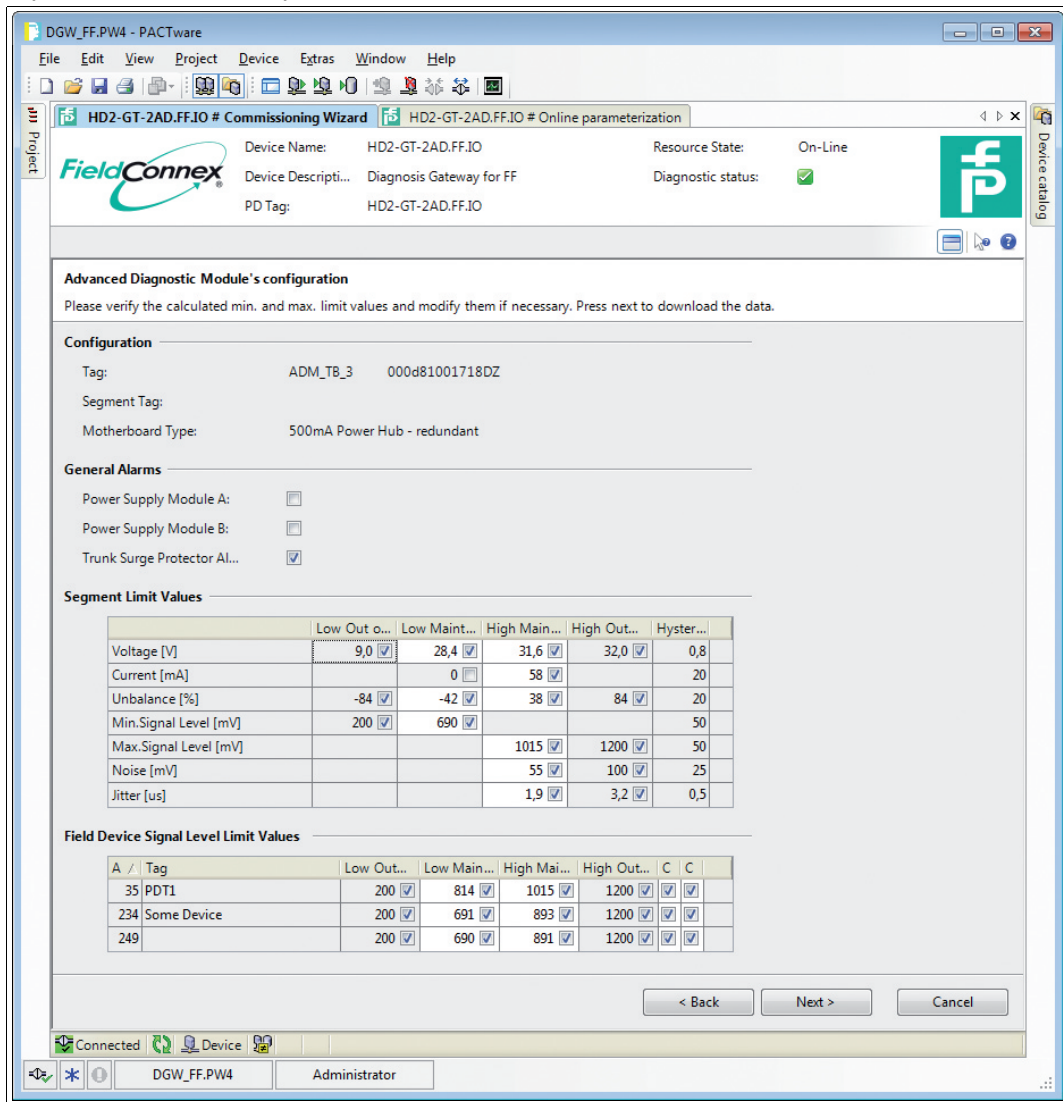

12. Review or optimize the calculated values, if required.

13. To store the calculated limits in the device, click **Next**.

↳ The limits are stored. The commissioning is complete.

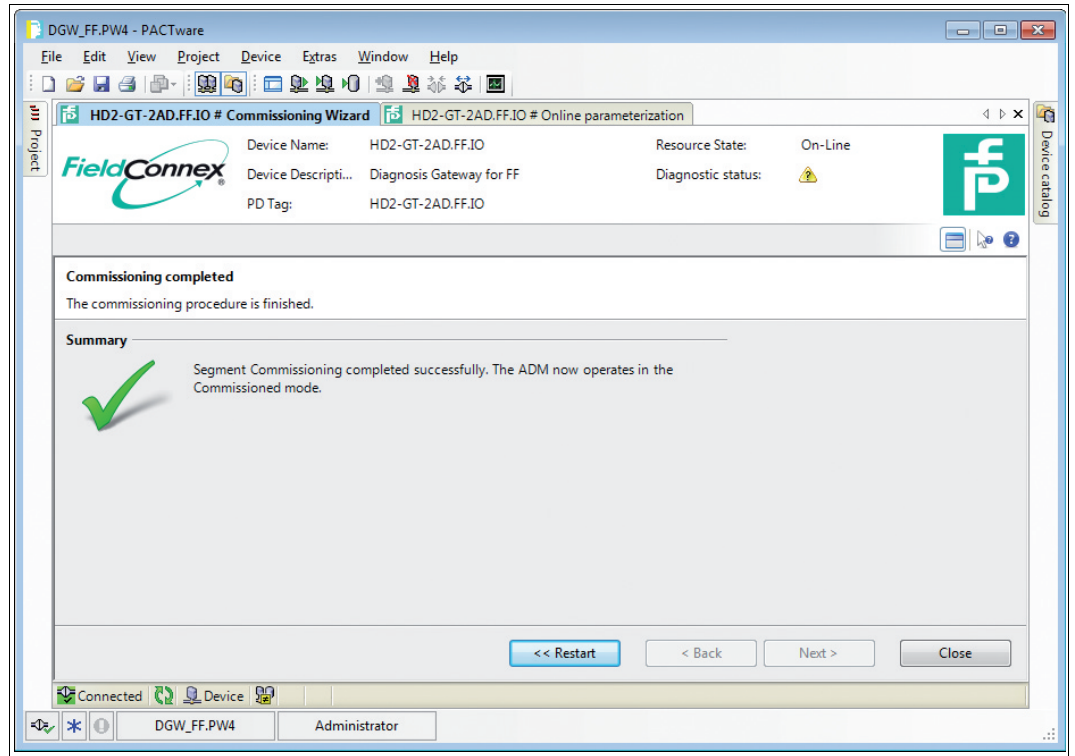

6.8.3 Diagnosis

The diagnosis window provides information on all currently active alarms of the diagnostic gateway. For the function blocks, resource block, and the IO transducer block, all available diagnostic functions are shown. The ADM transducer blocks additionally include the diagnostic messages of the expert system.

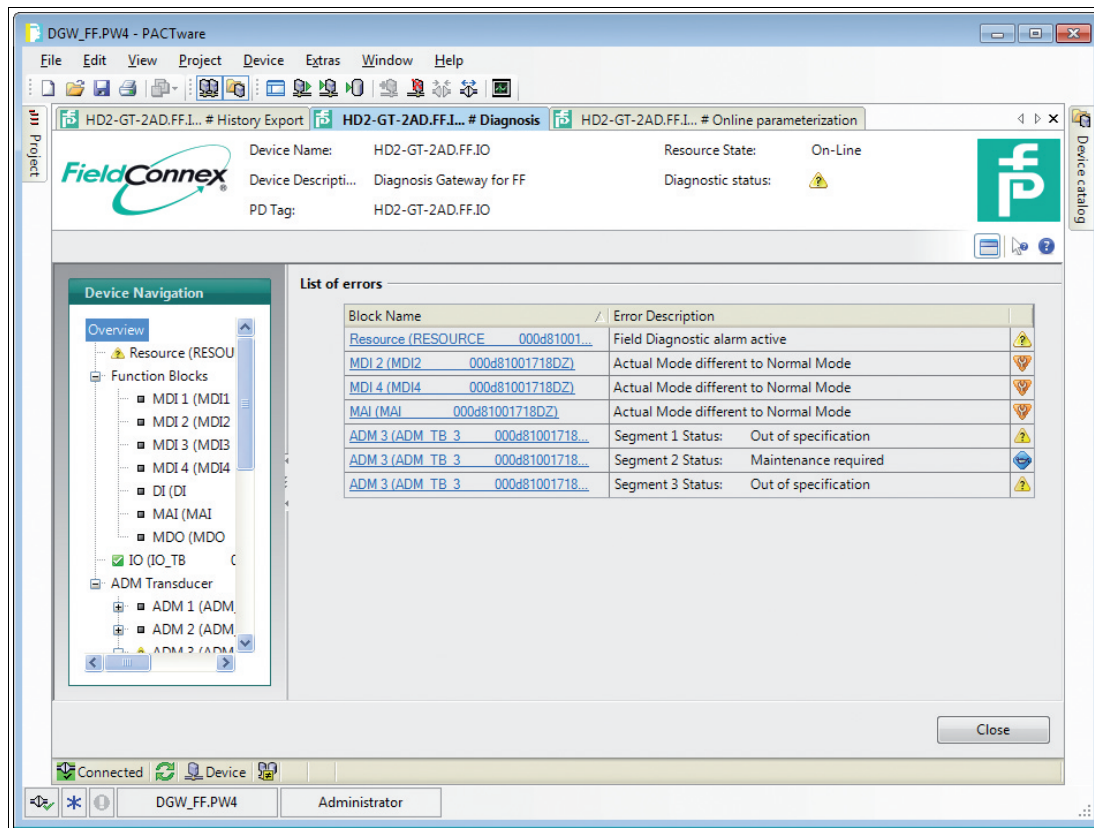

6.8.4 Measured Value

The measured value window provides easy access to the measurement data of the diagnostic gateway. The function blocks and the IO transducer blocks show the current I/O data.

Device Name: HD2-GT-2AD.FF.IO
 Device Description: Diagnostic Gateway FF
 PD Tag:
 Resource State: Standby
 Diagnostic status: ■

Create Snapshot Cancel Snapshot

Device Navigation

- Overview
 - Function Blocks
 - MDI 1 (MDI1)
 - MDI 2 (MDI2)
 - MDI 3 (MDI3)
 - MDI 4 (MDI4)
 - DI (DI) 00C
 - MAI (MAI) (
 - MDO (MDO)
 - IO (IO_TB) 000d
 - ADM Transducer
 - ADM 1 (ADM_TB_1)
 - ADM 2 (ADM_TB_2)
 - ADM 3 (ADM_TB_3)
 - ADM 4 (ADM_TB_4)
 - ADM 5 (ADM_TB_5)
 - ADM 6 (ADM_TB_6)
 - ADM 7 (ADM_TB_7)
 - ADM 8 (ADM_TB_8)
 - ADM 9 (ADM_TB_9)
 - ADM 10 (ADM_TB_1)
 - ADM 11 (ADM_TB_1)
 - ADM 12 (ADM_TB_1)
 - ADM 13 (ADM_TB_1)
 - ADM 14 (ADM_TB_1)
 - ADM 15 (ADM_TB_1)
 - ADM 16 (ADM_TB_1)

General

Tag: IO_TB 000d8100171DDZ
 Static Revision: 30
 Block Error: ✔

Measurement

Tag/Name	Value	Value	St
Binary Input 1	0	Bad - Out of service - Not limited	■
Binary Input 2	0	Bad - Out of service - Not limited	■
Binary Input 3	0	Bad - Out of service - Not limited	■
Binary Input 4	0	Bad - Out of service - Not limited	■
Binary Input 5	1	Bad - Out of service - Not limited	⚠
Binary Input 6	0	Bad - Out of service - Not limited	■
Binary Input 8	0	Bad - Out of service - Not limited	■
Temperature Input 1	-/- °C	Bad - Out of service - Not limited	✖
Board Temperature	30,20 °C	Bad - Out of service - Not limited	■
Board Humidity	26,60 %	Bad - Out of service - Not limited	■

Output Values

Tag/Name	Value	Value
Relay Output 1	0	Bad - Out of service - Not limited
Relay Output 2	0	Bad - Out of service - Not limited
Buzzer	0	Bad - Out of service - Not limited
Common Alarm Output	0	Bad - Out of service - Not limited

On/Off Controller Values

Tag/Name	Value	Value
On/Off Controller 1	0	Bad - Out of service - Not limited
On/Off Controller 2	0	Bad - Out of service - Not limited
On/Off Controller 3	0	Bad - Out of service - Not limited
On/Off Controller 4	0	Bad - Out of service - Not limited

The ADM transducer blocks include a more advanced view of the physical layer data of the connected FF-H1 segments.

System & Segment Measurements

The System and Segment Measurements tab provides a graphical representation of the currently measured values.

The analog measurement values are shown using a graph shown in the figure below. In the non-commissioned mode the values are classified as Excellent, Good, or Out of Specification. In the commissioned mode, the values are classified as No Error, Maintenance Required, or Out of Specification. See chapter 2.

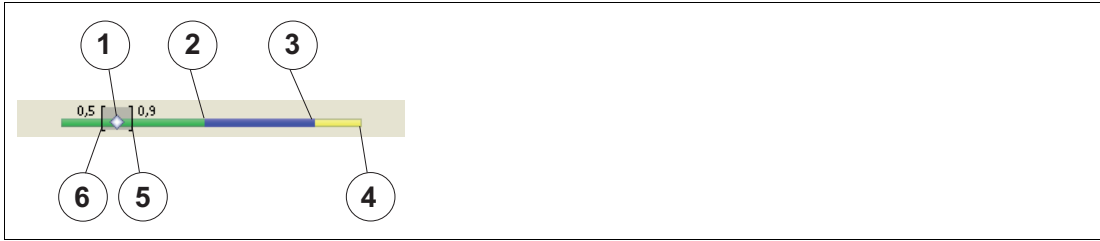

Figure 6.3 Signal level

- 1 Current value
- 2 Range for excellent value (green)
- 3 Range for good value (blue)
- 4 Range for exceeded value (yellow)
- 5 Maximum value occurred during operation
- 6 Minimum value occurred during operation

Magnifying Glass

Click on the magnifying glass to see current field device data.

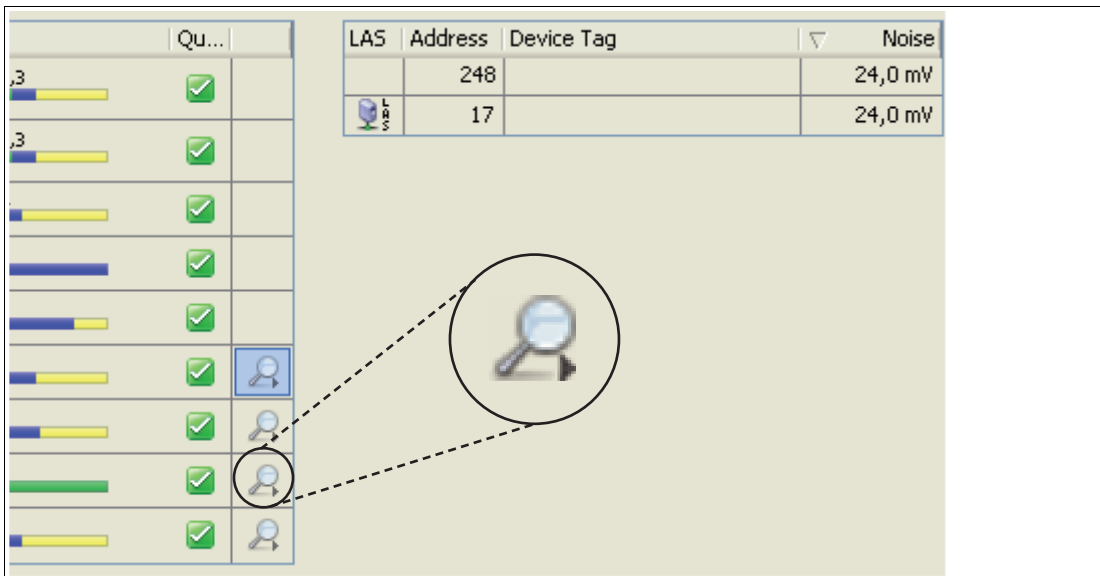

Figure 6.4 Magnifying glass



Showing specific field device measurements

In order to show specific field device measurements, click the corresponding magnifying glass in the last column.

The screenshot shows the PACTware software interface for a device named 'HD2-GT-2AD.FF.IO'. The 'System & Segment Measurements' tab is active, displaying the following information:

System Overview

- Tag: [Empty]
- Communication Active:
- Surge Protector Alarm:
- Motherboard Type: 500mA Power Hub - redundant
- Power Supply Module A:
- Power Supply Module B:

Segment Measurement

Current Va...	Value Range	Qu...
Primary Power Supply Voltage	26,7 V	26,7 T 26,7
Secondary Power Supply Voltage	26,7 V	26,7 T 26,7
Voltage	29,3 V	29,3 T 29,3
Current	0,0 mA	0,0 T 0,0
DC Unbalance	-2,0 %	-2,0 T -2,0
Noise	15,0 mV	15,0 T 15,0
Jitter	1,9 µs	1,2 T 2,4
Signal Level Minimum	763,0 mV	528,0 T 1768,0
Signal Level Maximum	900,0 mV	827,0 T 901,0
Coupler Alarms	Maint Req: 0	Out of Spec: 0

Jitter Table:

LAS	Address	Field Device Tag	Jitter
	234	Some Device	1,9 µs
	17	Host SEC	1,4 µs
	16	Host PRI	1,3 µs
	35		1,2 µs

Figure 6.5 System & Segment Measurements tab in non-commissioned mode

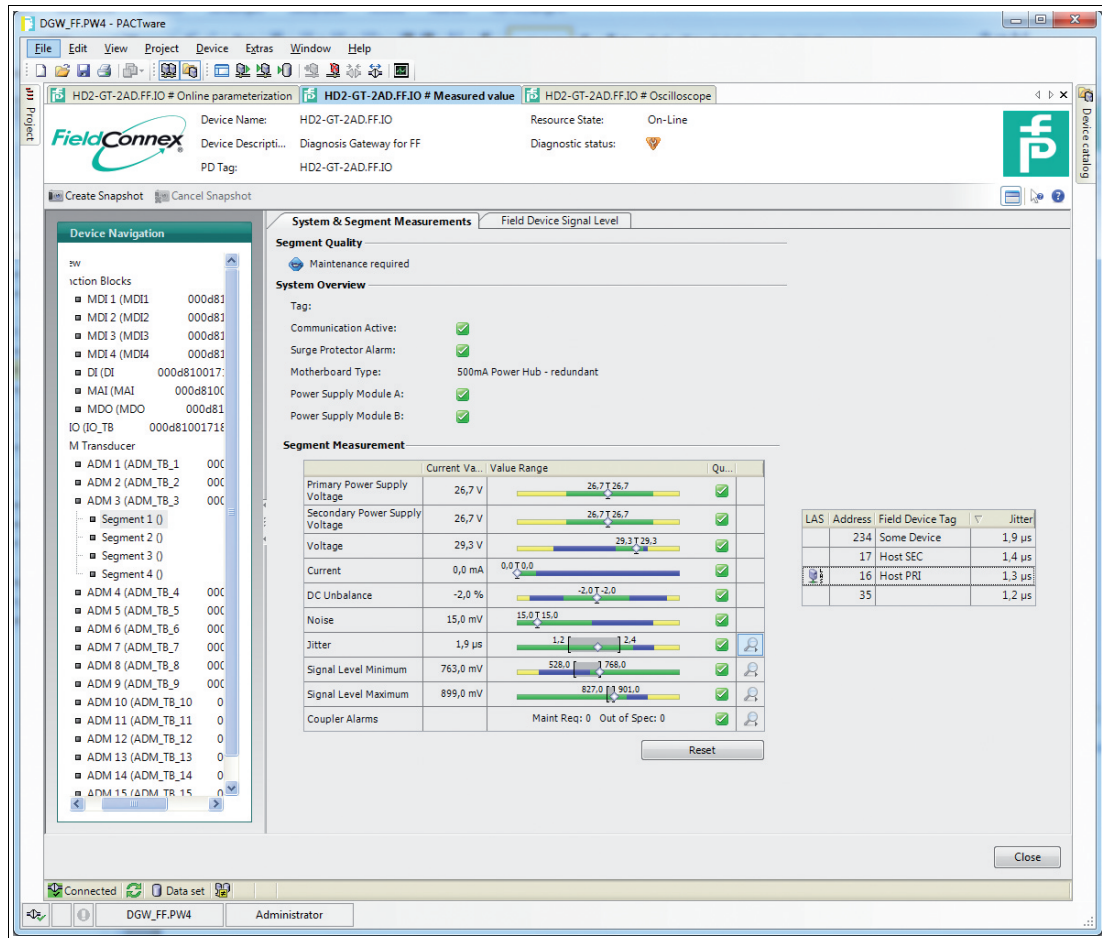
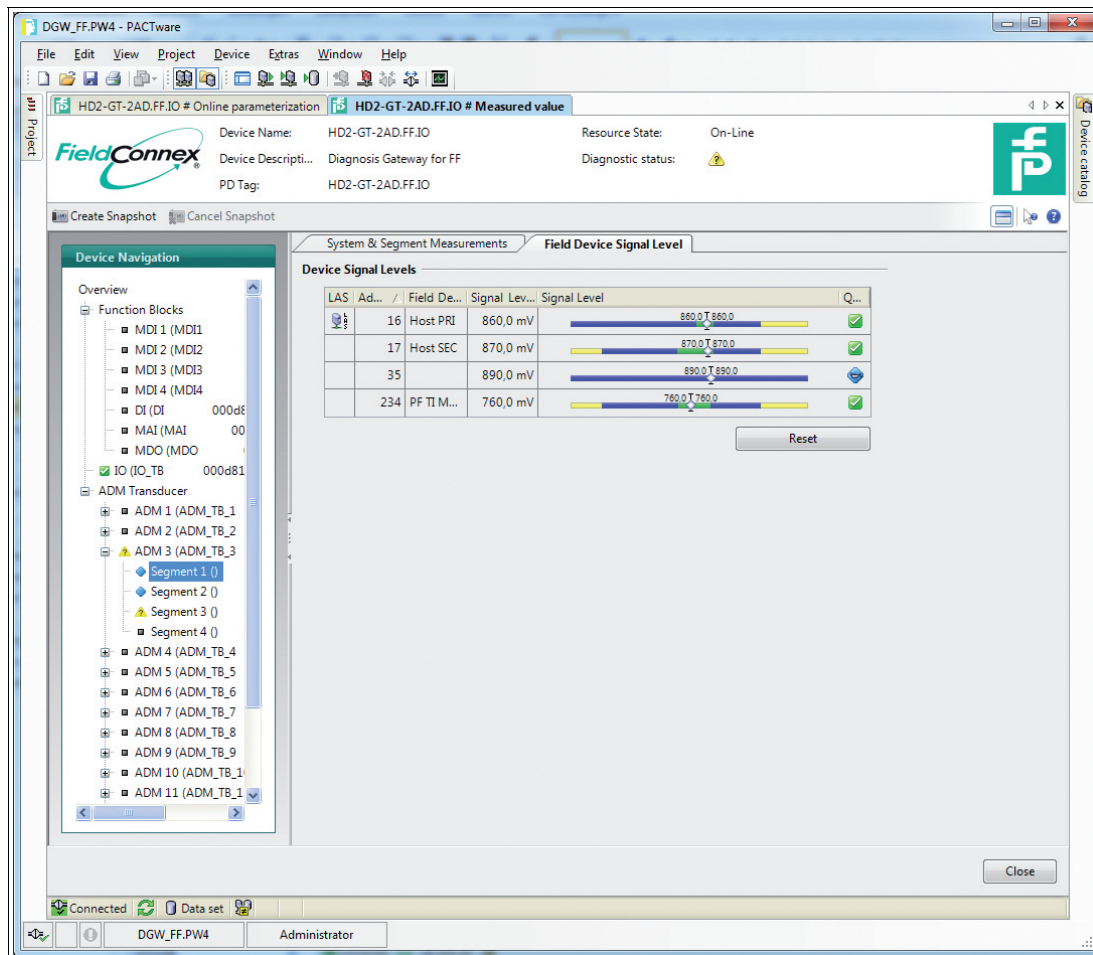

Figure 6.6 System & Segment Measurements tab in commissioned mode

Field Device Signal Level

The field device signal level tab shows a graphical overview of the measured field device signal levels. For a detailed description of the bar colors, see the system & segment measurements tab description.

In commissioned mode, the bar for unconfigured field devices is completely blue. This is the case because no alarm limits exist for this device.



6.8.5 Create a Snapshot

A snapshot provides a detailed overview of the current segment settings and the communication quality. For data exchange, a snapshot containing the current min/max noise, jitter and signal level values of each device and the rated segment values can be printed or exported as an image, text, or PDF document.



Creating a Snapshot

In order to create a snapshot, proceed as follows:

1. Right-click the **Advanced Diagnostic Module** in the project section.
2. Choose **Measured value**.

↳ The system & segment measurements window appears.

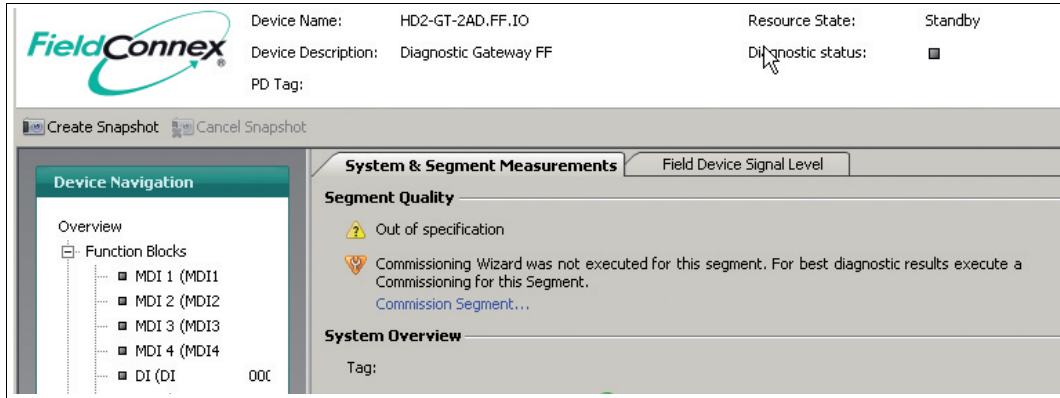

3. Choose **Create Snapshot** or **Create Snapshot including Oscilloscope Recordings**. The second option includes characteristic oscilloscope recording fragments for each field device into the report.

↳ Once all snapshot data is collected, the **Save Snapshot Report** window appears.

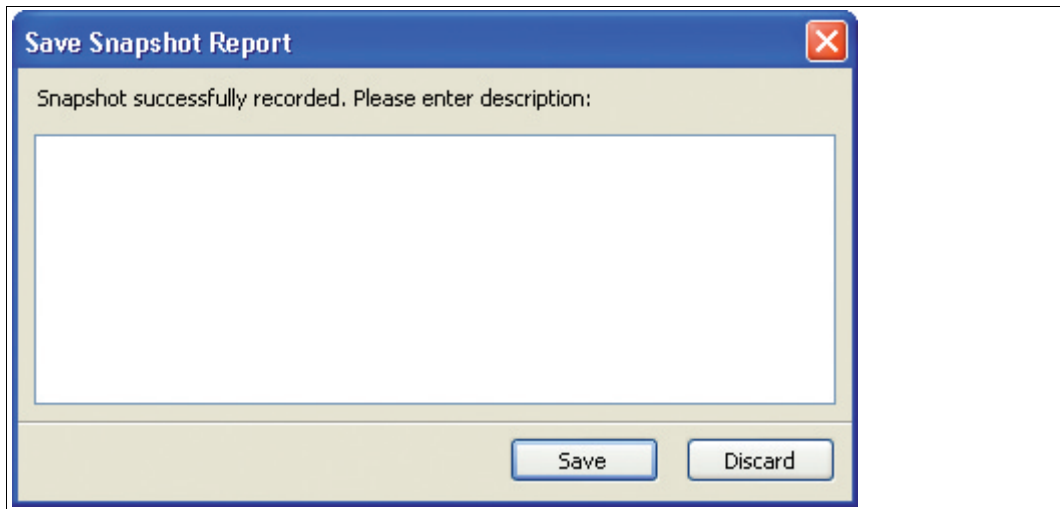

Figure 6.7 Save snapshot report window

4. Enter a description for the snapshot.
5. Choose **Save** to save the snapshot.

↳ The snapshot explorer window appears. See chapter 6.8.7

6.8.6 History Export



Note

In order to export history data, an Ethernet connection to the DGW-FF is required.

6.8.6.1 Long-Term History

The long-term History function enables you to collect and store data in well-defined recording intervals. The minimum and maximum value of each measured value within the recording interval are stored as one data set. Recording intervals can range from 4 hours up to 7 days.



Note

The data storage is limited to 100 data sets. New data sets will overwrite existing ones, which means that data set 101 overwrites data set 1.

Depending on the defined recording interval, the long-term history can range from 17 days (4 h * 100 = 400 h = approx. 17 days) up to approx. 2 years.



Defining a Recording Interval

In order to define the recording interval for the long-term history, proceed as follows:

1. Open online parameterization.
2. Select an ADM transducer block.
3. Set block mode to "OOS" if required.
4. Move to the configuration tab and adjust the history period.
5. Choose **Apply** to confirm the changes.
6. Restore the block mode.

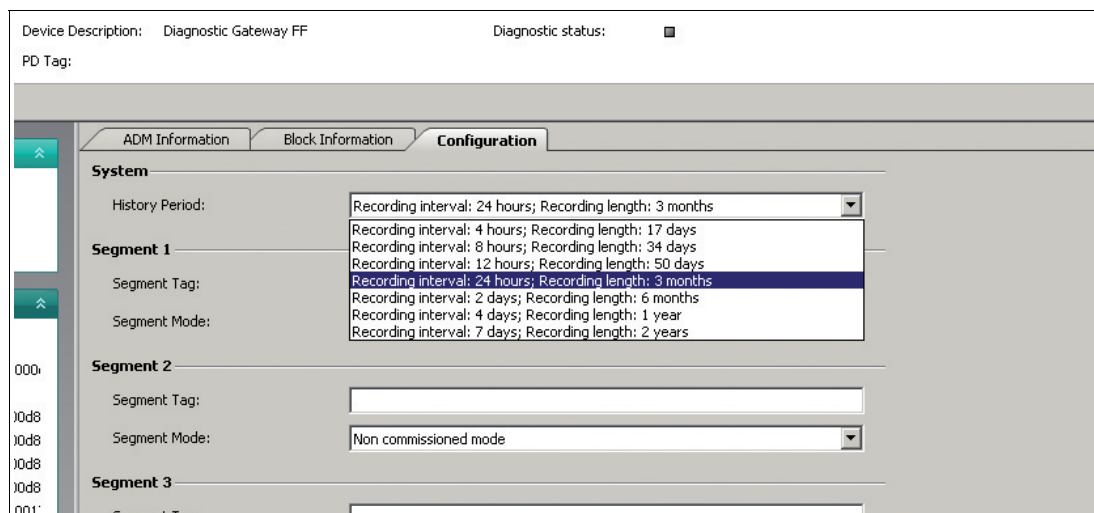

6.8.6.2 Export History

The export history function enables you to convert the long-term history data into a commonly used document format, in order to use this data for your own calculations. The long-term history can be exported as Microsoft® Excel document, comma-separated values (CSV file), or binary history file (HIS).



Exporting the History

In order to export the long-term history data, proceed as follows:

1. Select "Segment to Export the History data for".
2. Select the segment and choose **Start**.

- Select the required file format in the **Export Type** section and enter a file name in the **Filename** field.

Figure 6.8 Export type and export settings

6.8.6.3 Excel Export Feature

The diagnostic manager provides feature for exporting history data to Microsoft® Excel that enables fast and easy data exchange and reformatting of your physical layer data.

The physical layer data is exported into a special template. This template is designed to provide a detailed overview of all relevant parameters and enables you to create diagrams with one click.

Timestamp	Primary Volt. /V Maximum	Minimum	Secondary Volt. /V Maximum	Minimum	Voltage /V Maximum	Minimum
1465	31,30	31,30	31,30	31,30	27,10	27,10
1466	31,30	31,30	31,30	31,30	27,10	27,10

Figure 6.9 History data overview in Excel

6.8.7 Snapshot Explorer

The snapshot explorer simplifies administration and enables printing existing snapshots and reports. These reports can be printed or exported as an image, text, PDF document, or diagnostic module snapshot file (DMS) file.



Note

DMS is a file format for data exchange created by Pepperl+Fuchs.

2 different templates can be selected: A clearly arranged default template and a compact template that contains the same information using less space. You can launch the report using Microsoft® Excel. This spreadsheet enables you to generate diagrams and perform individual calculations based on the report data.



Opening the Snapshot Explorer

In order to open the snapshot explorer, proceed as follows:





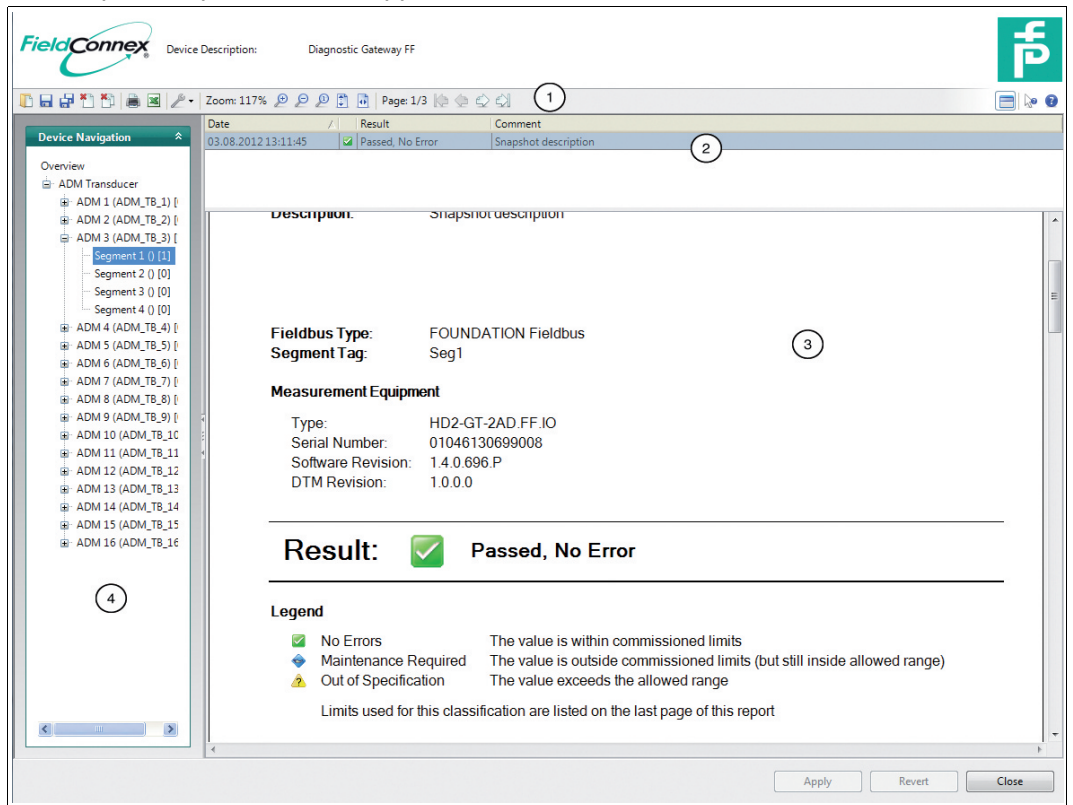











1. Right-click the **Advanced Diagnostic Module** in the project section.
2. Choose **Additional Functions > Snapshot Explorer**.

↳ The snapshot explorer window appears.



1. Toolbar
2. Snapshot collection
3. Report preview
4. Segment navigation panel

6.8.7.1 Snapshot Toolbar

Button	Name	Result
	Open	Open a saved report.
	Copy to (Export)	Copy the selected report to another location. File types: PDF, RTF, TXT, DMS
	Copy all to (Export all)	Copy all reports to another location. File type: DMS
	Delete	Delete the selected report.
	Delete all	Delete all reports.
	Print	Print the selected report.
	Excel	Export the selected report in Excel.
	Settings	Choose: <ul style="list-style-type: none"> Paper size (A4 or letter) Report type (compact template or detailed template)
	Zoom in	Enlarge the report.
	Zoom out	Reduce the report.
	Zoom 100%	View of the report of 100 %.
	Fit to height	Fit the view of the report on the height.
	Fit to width	Fit the view of the report on the width.
	First page	Go to the first page of the report.
	Previous page	Go to the previous page of the report.
	Next page	Go to the next page of the report.
	Last page	Go to the last page of the report.

6.8.8 Fieldbus Oscilloscope

For further information on the fieldbus oscilloscope functionality, see chapter 5.12.

6.8.9 Tag Import Wizard

The tag import wizard can be used to import segment and device tags from process control systems (PCS) to the DGW-FF.

The basic concept described in this chapter is the same independent of the PCS used. How to import data from the supported PCS and some PCS-specific behavior is described at the end of this chapter. Supported process control systems are:

- Emerson DeltaV
- Honeywell Experion PKS
- Yokogawa PRM



Importing Tags in General

1. Launch the tag import wizard.
2. In order to create a new topology, choose **Create a new topology**.
↳ The wizard clears all tags saved on the DGW-FF.
3. In order to update tags already loaded, choose **Update existing project topology**.
↳ The wizard assigns imported tags to the currently existing tags based on the segment tag.

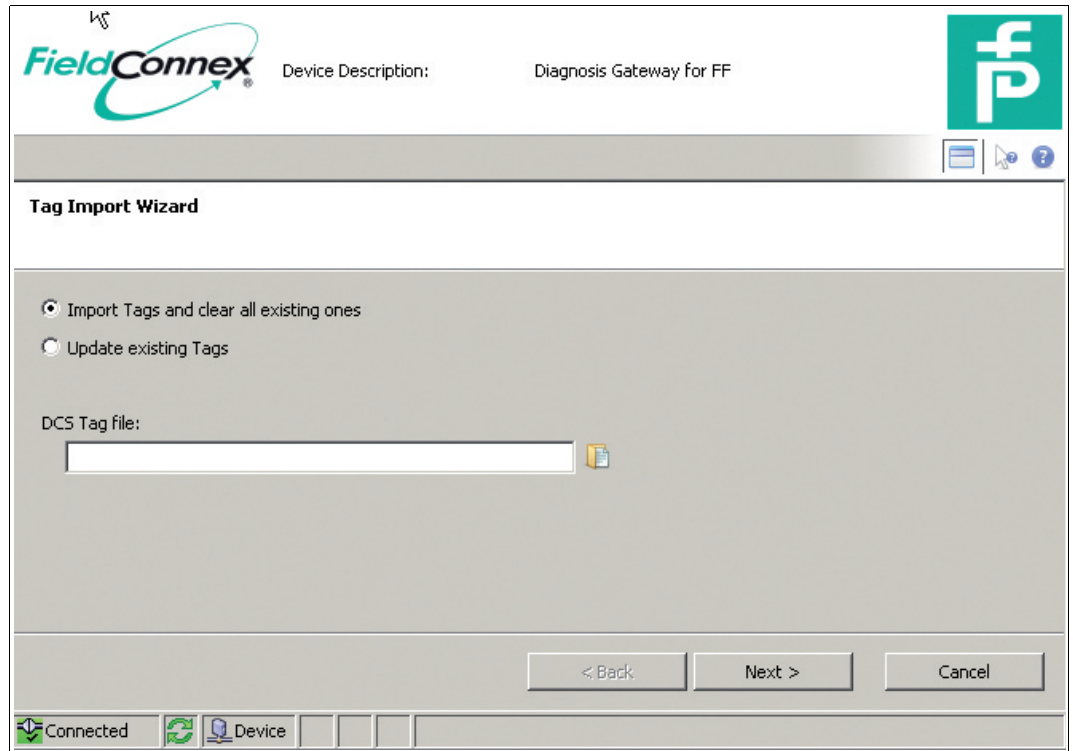

4. Select the PCS file to be imported and click **Next**.

↳ The segment selection list shows all segments found in the imported PCS file.

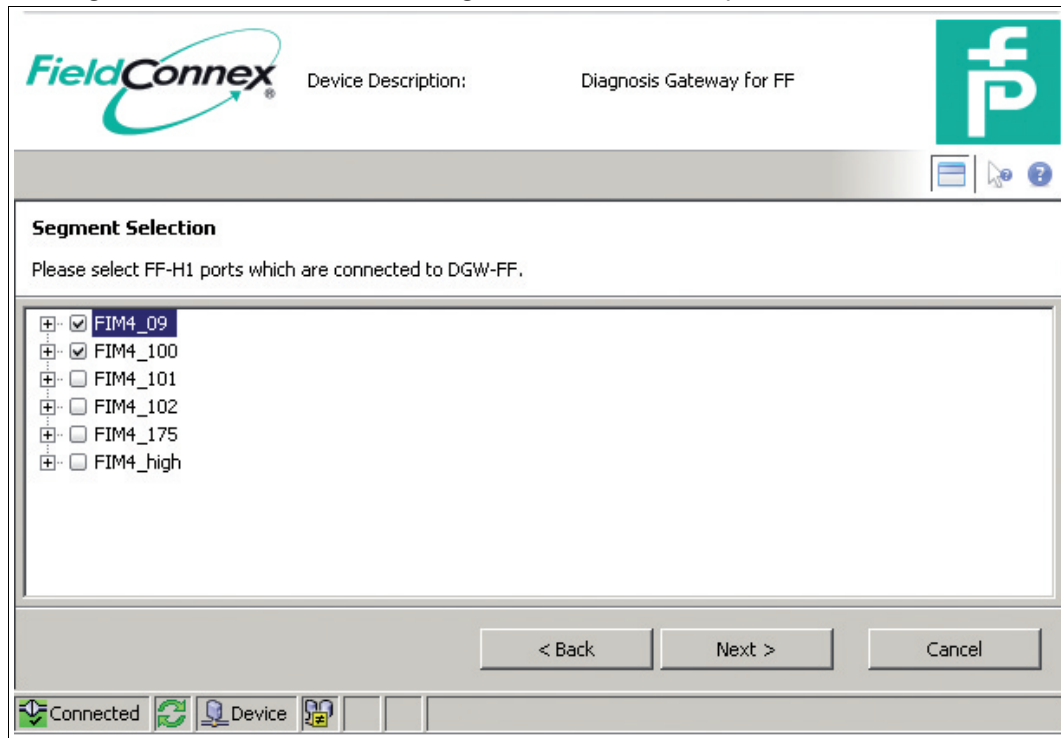

5. Select the segments that are attached to the DGW-FF and click **Next**.

↳ The software assigns the segments to the ADMs automatically. The default handling depends on the individual PCS.

- In order to change the default assignment, edit the ADM addresses.

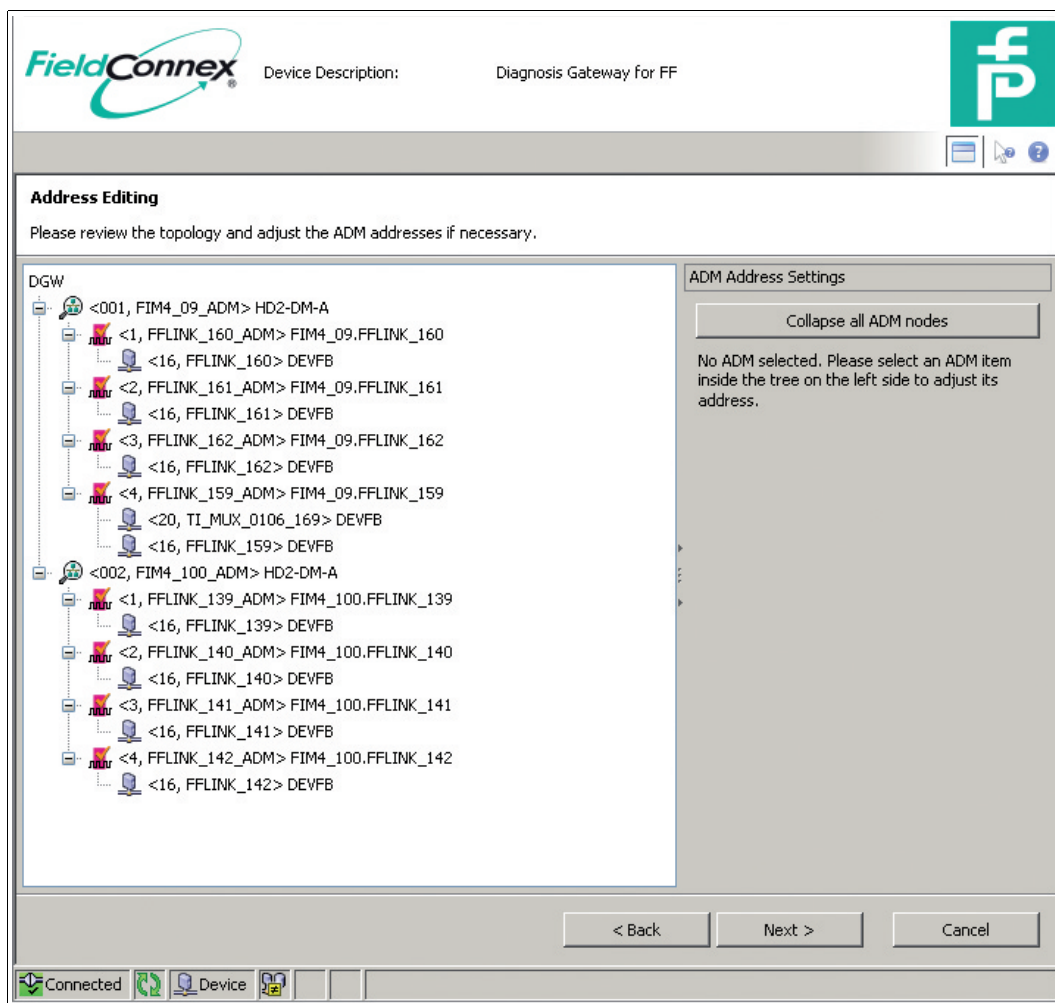

- Click **Next**.

↳ The software sets the ADM_TB block tags and the segment tags according to the imported data. The software also creates a configured field device for each imported field device tag and assigns the device tag to this device.

6.8.9.1

Export Tags from Emerson DeltaV

Exporting Tags from Emerson DeltaV



- Open the Emerson DeltaV Explorer.

2. Right-click on control network and choose **Export**.

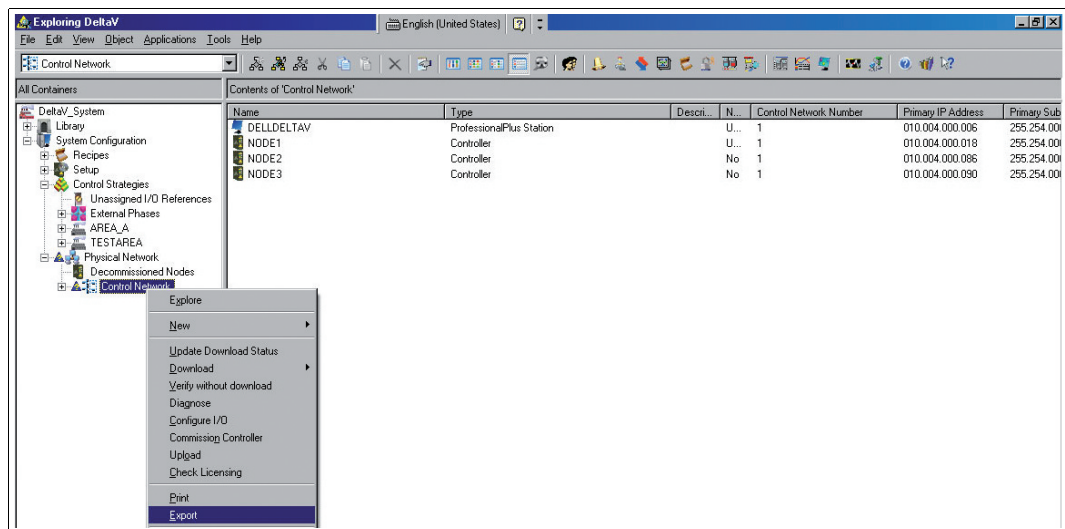

3. Enter the file name and save the file.

During import, the tags are assigned to the ADM transducer blocks in the following way:

FF-H1 cards are assigned from the lowest to the highest card number to the transducer blocks. Since a DeltaV H1 card has 2 segments, and an ADM has 4 segments, the cards are assigned using the following algorithm:

- Check if 4 continuously addressed Emerson cards with the addresses 1 ... 4, 5 ... 8, (and so on) contain non-redundant cards.
 - If the block contains at least 1 non-redundant card, the card addresses 1 + 2, 3 + 4, (and so on) are combined at an ADM. If redundant cards are in this block, the ADM segments reserved for the redundant card remain unused.
 - If the block only contains redundant cards, the cards with the addresses 1 ... 4, 5 ... 8, (and so on) are mapped to 1 ADM. This is possible because in a redundant system, even address numbers are not used.

6.8.9.2 Export Tags from Honeywell Experion

Exporting Tag from Honeywell Experion



1. On Experion Server, open configuration studio and select **Control Strategy > Configure process control strategies** to open the control builder.
2. Right-click on a root in the project assignment window. Choose **Export**.
3. Select at least all **FIM4, FIM8, Fieldbus Devices and Templates for Fieldbus Devices**. Choose a directory to export to, and click **Export..** Typically, it is the best way to select all and export.

↳ FIMs are assigned from the lowest to the highest device index to the ADM transducer blocks. Any FIM8 allocates to consecutive ADM transducer blocks.

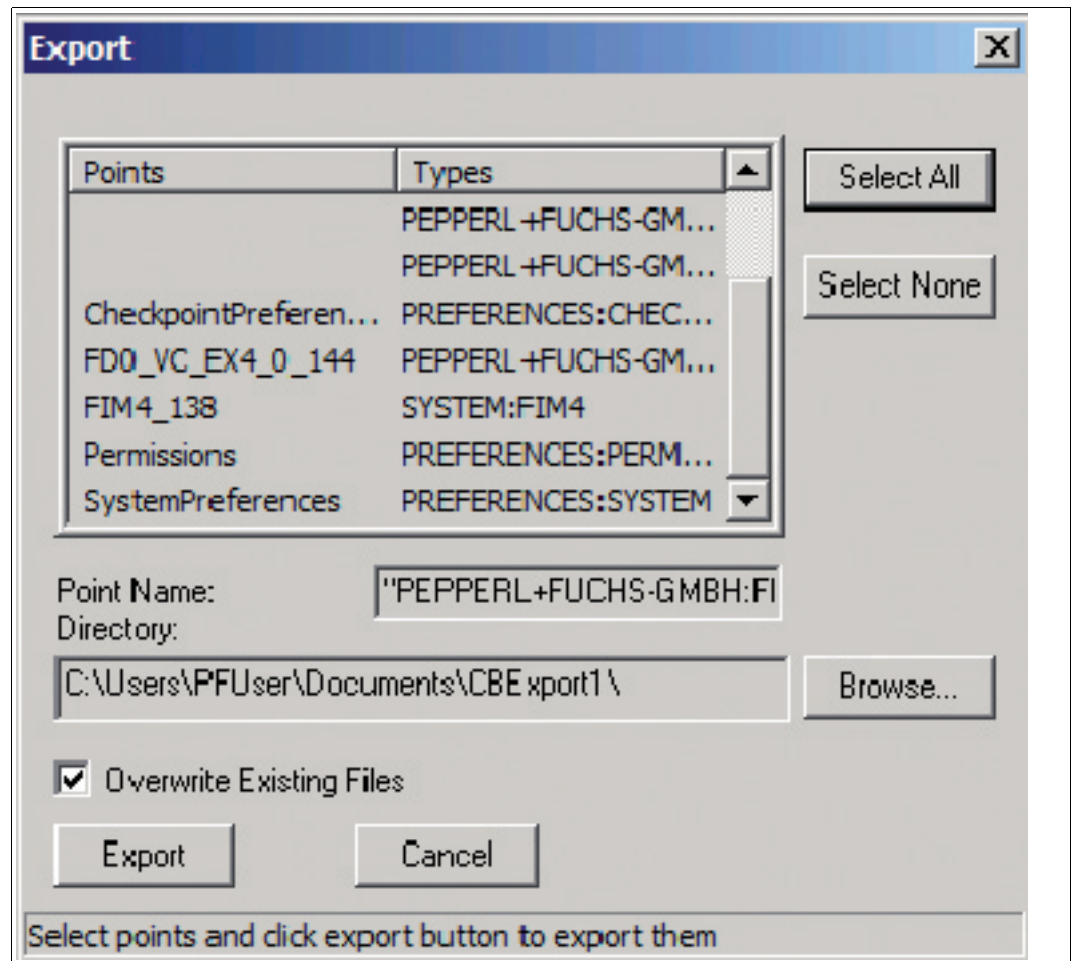

6.8.9.3 Export Tags from Yokogawa Plant Resource Manager

Exporting Tags from Yokogawa Plant Resource Manager



1. Start the plant resource manager (**Start > All Programs > YOKOGAWA PRM > Plant Resource Manager**).
2. Choose **File > Export > Maintenance Info**.

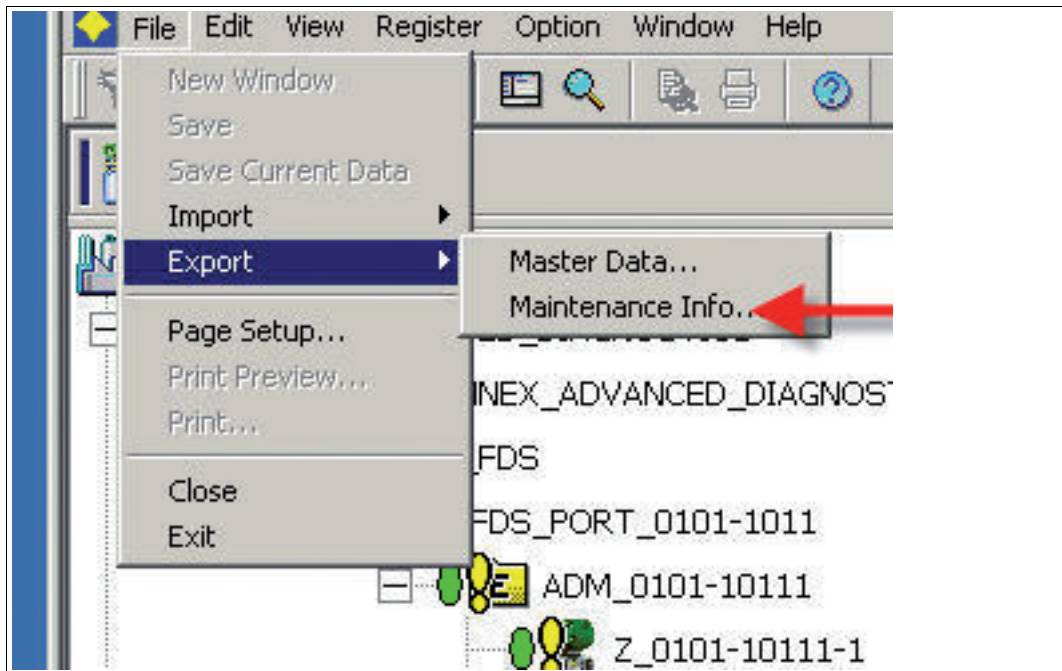

↳ The **Export Maintenance Info** window appears.

3. Select **Browse**.

↳ The **Device Selection** window appears.

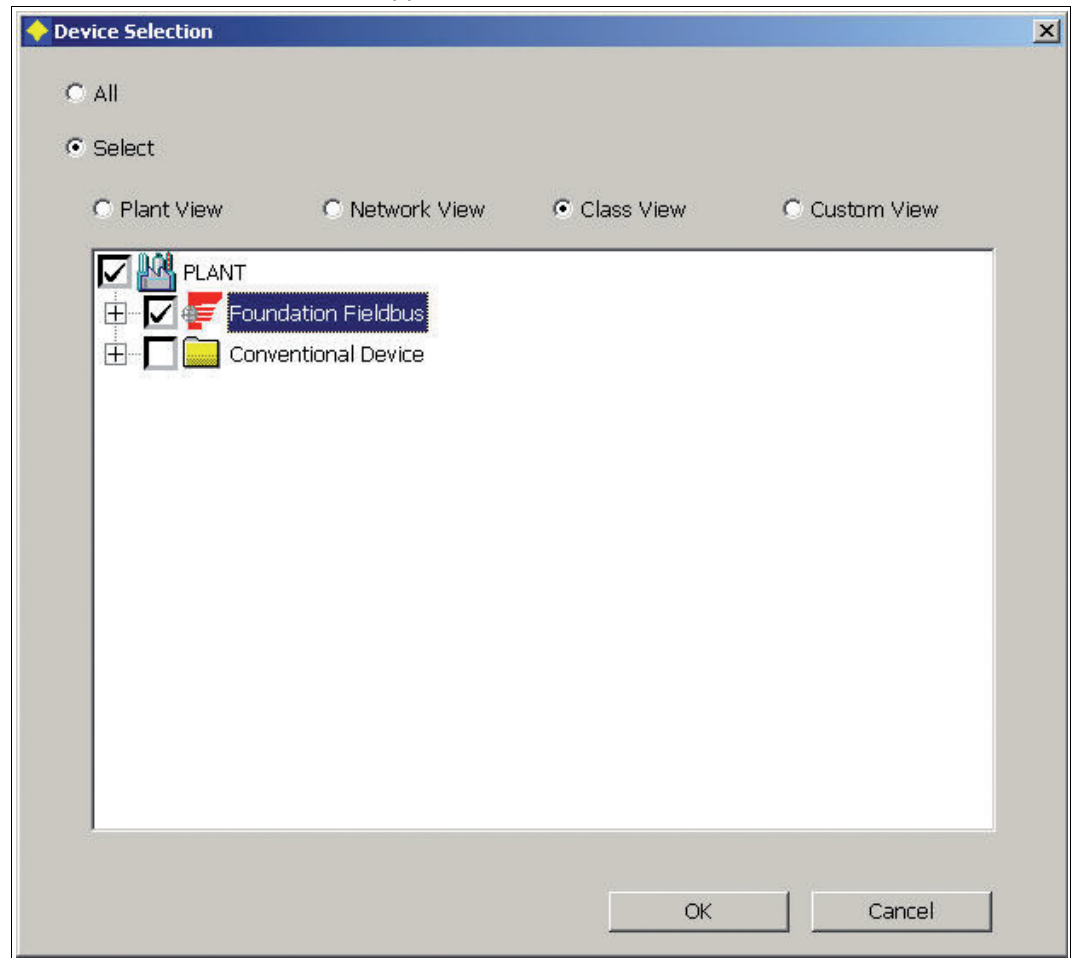

4. Select all FOUNDATION Fieldbus devices and click **OK**.

↳ The export maintenance info window appears.

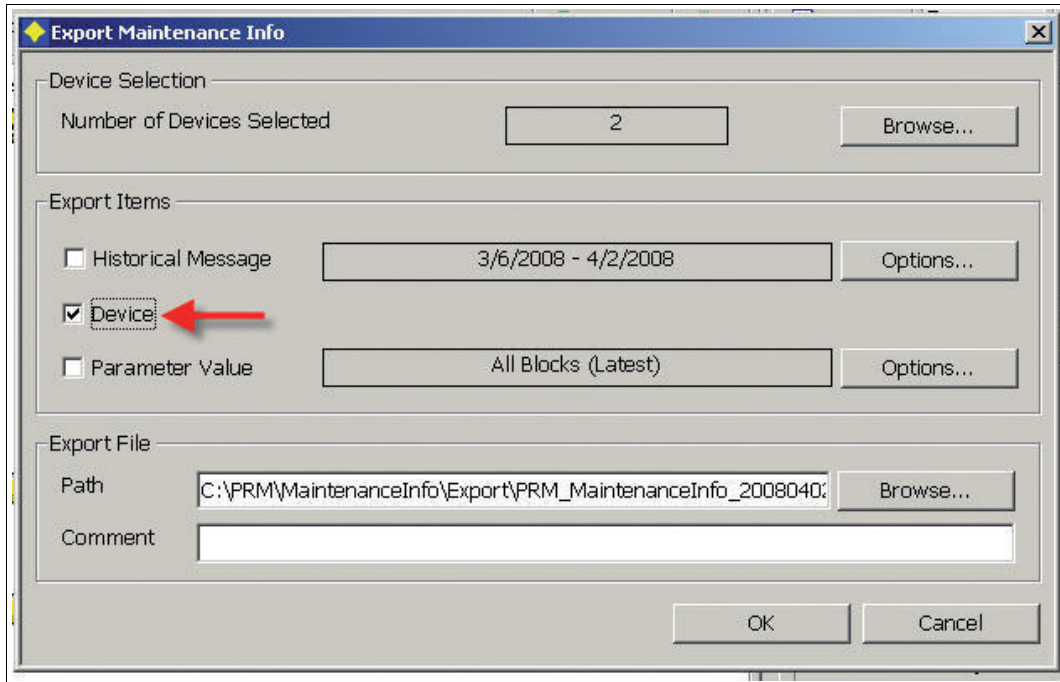

5. Activate **Device** and click **OK**.

↳ The export starts.

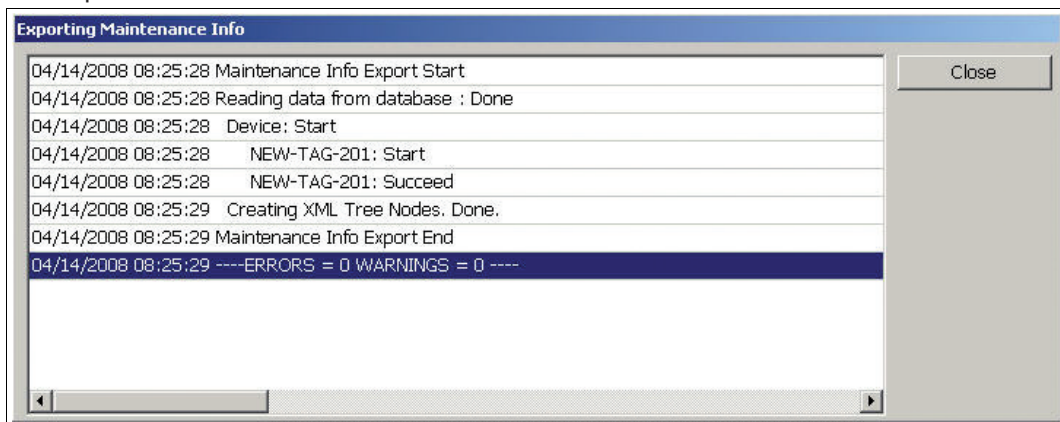

6. After the export has finished, click **Close**.

ALF111 devices are assigned to ADM transducer blocks from low to high device path.

6.8.10 Reporting Wizard

The FDS reporting wizard allows creating reports on all segments connected to a diagnostic gateway. Currently, one report type is supported:

- Surge protector status

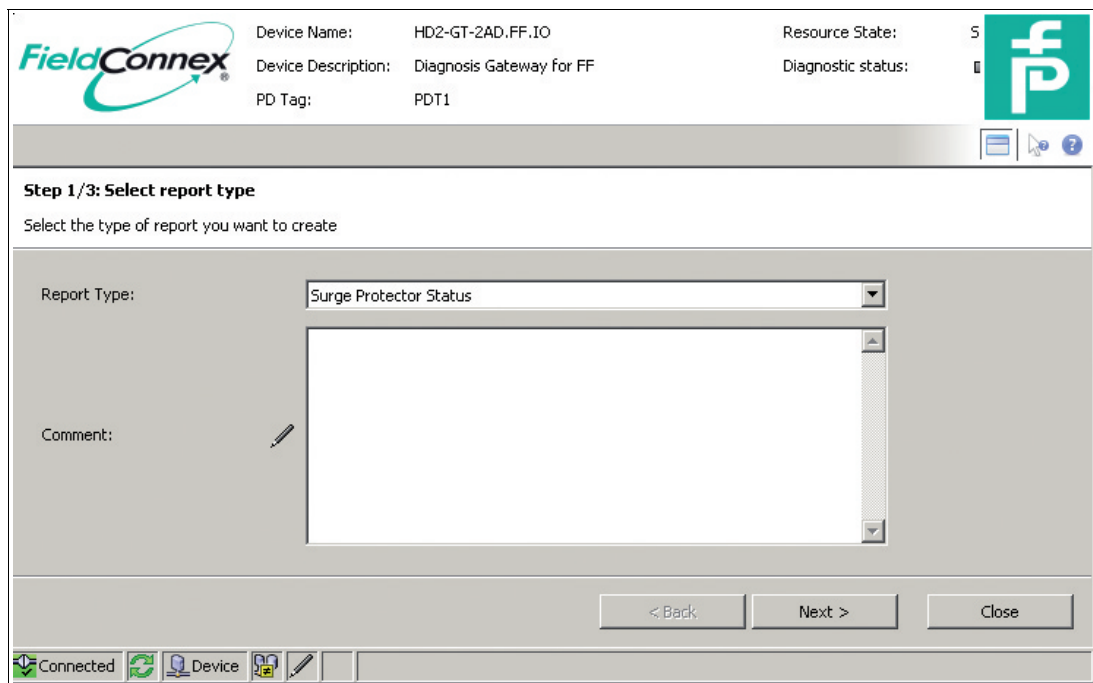

If you use FieldConnex® surge protectors with diagnostics, this report provides an overview of all current issues that are related to surge protectors. It can be used to check the surge protectors after a surge incidence.



Checking the Surge Protector Status

1. Start the reporting wizard.
2. Select the report type.
3. Optionally enter a comment to include into the report.
4. Click **Next**.

↳ The report is being generated.

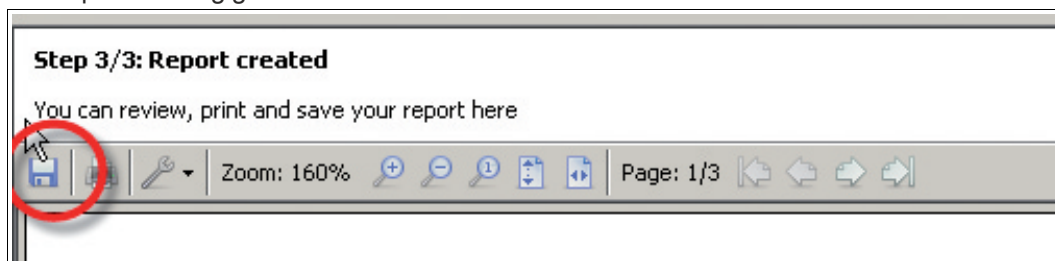

7 Cabinet I/O

Besides ADM access functionality, the diagnostic gateway KT-MB-GT2AD.FF.IO provides I/O functions mainly for cabinet management applications. The following inputs and outputs are available:

- Inputs:
 - 2 binary inputs that can also be used as frequency inputs.
 - 4 binary inputs (NAMUR sensors)
 - 2 temperature inputs for use with PT100 sensors that can also be used as binary inputs.
 - 1 temperature sensor integrated on the motherboard.
 - 1 humidity sensor integrated on the motherboard.
- Outputs:
 - 2 relay outputs.
 - 1 common alarm output, a volt-free contact for alarm loops; off=closed, on=open.
 - 1 buzzer.

Integrated on/off controllers allow local control functionality inside the diagnostic gateway, e.g., for thermostat controls.

This functionality is provided for the FF integration, as well as for the FDS/OPC integration. The main difference between these 2 types is the possibility to interact with FF function blocks where the FDS/OPC integration does only support local control. Access to the I/O functionality is provided in the following way:

- **FF Integration**

The I/O functionality is provided as an FF transducer block. Several channels for the function blocks allow to access the input and outputs. See chapter 7.5

- **FDS/OPC Integration**

The FDS port DTM provides an online and offline parameterization user interface for this functionality. This port behaves like an FF transducer block, i.e., the block must be set to "OOS" before any parameter can be changed and must be switch back to auto for operation. Handling of the resource block mode is not required.

The I/O functionality is not integrated with the OPC server. The local control functionality can be used as described in this chapter and alarms to a PCS can be sent using the common alarm output.

The common alarm output of the I/O functionality is also provided on the KT-MB-GT2AD.FF and can be used for a volt-free contact integration of the ADM functionality in FF integration mode. See chapter 4.4

7.1 Field Diagnostics

The inputs of the IO_TB can be integrated with field diagnostics in either of the following ways:

- Map a binary input to field diagnostics: When the corresponding bit in FD binary * map is set, a binary input value of "1" triggers the field diagnostics condition.
- Compare analog inputs values against limits: All analog inputs have Hi and Lo Maintenance Required and Out of Specification limit settings. Whenever the input value is outside the selected limits, the field diagnostics condition is triggered.
- Input lead break/short circuit detection is mapped to field diagnostics. Whenever a lead break/short circuit condition is detected, the corresponding field diagnostics condition is triggered.

Condition	Description	Default Mapping
IO Out of Specification	Any bit in IO_TB.FD_OOS_ACTIVE is set when IO_TB has the target mode "AUTO"	Offspec
IO Maintenance Required	Any bit in IO_TB.FD_MR_ACTIVE is set when IO_TB has the target mode "AUTO"	Maintenance Required
IO Fail	Any bit in IO_TB.BINARY_ERRORS or IO_TB.ANALOG_ERRORS is set when IO_TB has the target mode "AUTO"	Fail

For more information on field diagnostics conditions, see chapter 8.4

You find more details on the configuration options for field diagnostics in the following sections.

7.2 Input Configuration

Most device inputs are multifunctional inputs that can be used for different types of I/O signals.



Note

Analog Limit Values

You can configure Hi and Lo Maintenance Required and Out of Specification limits for analog input values. If you do not want to use these limits, you can disable this functionality by entering the following information in the configuration:

- For "low": <<<
- For "high": >>>

This combination of characters means +- infinite and disables the functionality.

7.2.1 Frequency/Binary Inputs

- Lead breakage and short circuit detection can be enabled and disabled.
- Use as frequency input: Use input as frequency input instead of binary input.

The following settings are only used in binary mode:

- Invert: Invert binary input value.
- Use fault state: If an error is detected, the input status remains "GOOD" instead of becoming "BAD". Depending on the setting of "Fault state to value", the input value remains on the last "GOOD" value or changes to the fault state value.
- Fault state to value: If enabled, the input value changes to the value of the "Fault state" bit when an error is detected instead of remaining on the last "GOOD" value.
- Fault state: Fault state value used with "Fault state to value".
- Field Diag Out Of Specification: If this option is set, a logical 1 at the binary input triggers an IO_TB Out-of-Specification condition.
- Field Diag Maintenance Required: If this option is set, a logical 1 at the binary input triggers an IO_TB Maintenance-Required condition.

The following settings are only used in frequency mode:

- High Out of Specification: If the currently measured frequency value is higher than the High-Out-of-Specification limit, the field diagnostics IO_TB-Out-of-Specification condition is triggered.

- High Maintenance Required: If the currently measured frequency value is higher than the High-Maintenance-Required limit, the field diagnostics IO_TB-Maintenance-Required condition is triggered.
- Low Maintenance Required: Like High Maintenance Required, but for measured frequency lower than the Low-Maintenance-Required value.
- Low Maintenance Required: Like High Maintenance Required, but for measured frequency lower than the Low-Maintenance-Required value.
- Hysteresis: In order to avoid the flickering of diagnostics, a hysteresis value can be configured.

7.2.2 Binary Inputs

- Lead breakage and short circuit detection can be enabled and disabled.
- Invert: Invert binary input value.
- Use fault state: If an error is detected, the input status remains "GOOD" instead of becoming "BAD". Depending on the setting of "Fault state to value", the input value remains on the last "GOOD" value or changes to the fault state value.
- Fault state to value: If enabled, the input value changes to the value of the "Fault state" bit when an error is detected instead of remaining on the last "GOOD" value.
- Fault state: Fault state value, used with "Fault state to value".
- Field Diag Out Of Specification: If this option is set, a logical 1 at the binary input triggers an IO_TB-Out-of-Specification condition.
- Field Diag Maintenance Required: If this option is set, a logical 1 at the binary input triggers an IO_TB-Maintenance-Required condition.

7.2.3 Temperature/Binary Inputs

- Lead breakage and short circuit detection can be enabled and disabled.
- Use as binary input: Use input as binary input instead of temperature input.

The following settings are only used in binary mode:

- Invert: Invert binary input value.
- Use fault state: If an error is detected, the input status remains "GOOD" instead of becoming "BAD". Depending on the setting of "Fault state to value", the input value remains on the last "GOOD" value or changes to the fault state value.
- Fault state to value: If enabled, the input value changes to the value of the "Fault state" bit when an error is detected instead of remaining on the last "GOOD" value.
- Fault state: Fault state value, used with "Fault state to value".
- Field Diag Out Of Specification: If this option is set, a logical 1 at the binary input triggers an IO_TB-Out-of-Specification condition.
- Field Diag Maintenance Required: If this option is set, a logical 1 at the binary input triggers an IO_TB-Maintenance-Required condition.

The following settings are only used in temperature mode:

- High Out of Specification: If the currently measured temperature value is higher than High-Out-of-Specification limit, the field diagnostics IO_TB-Out-of-Specification condition is triggered.
- High Maintenance Required: If the currently measured temperature value is higher than High-Maintenance-Required limit, the field diagnostics IO_TB-Maintenance-Required condition is triggered.
- Low Maintenance Required: Like High Maintenance Required, but for measured temperature lower than Low-Maintenance-Required value.

- Low Out of Specification: Like High Out of Specification, but for measured temperature lower than Low-Out-of-Specification value.
- Hysteresis: In order to avoid flickering of diagnostics, a hysteresis value can be configured.
- Unit: Select the unit for temperature measurement.

7.2.4 Board Humidity

- High Out of Specification: If the currently measured humidity value is higher than the High-Out-of-Specification limit, the field diagnostics IO_TB-Out-Of-Specification condition is triggered.
- High Maintenance Required: If the currently measured humidity value is higher than High-Maintenance-Required limit, the field diagnostics IO_TB-Maintenance-Required condition is triggered.
- Low Maintenance Required: Like High Maintenance Required, but for measured humidity lower than the Low-Maintenance-Required value.
- Low Out of Specification: Like High Out of Specification, but for measured humidity lower than the Low-Out-of-Specification value.
- Hysteresis: In order to avoid flickering of diagnostics, a hysteresis value can be configured.

7.2.5 Board Temperature

- High Out of Specification: If the currently measured temperature value is higher than High-Out-of-Specification limit, the field diagnostics IO_TB-Out-of-Specification condition is triggered.
- High Maintenance Required: If the currently measured temperature value is higher than High-Maintenance-Required limit, the field diagnostics IO_TB-Maintenance-Required condition is triggered.
- Low Maintenance Required: Like High Maintenance Required, but for measured temperature lower than the Low-Maintenance-Required value.
- Low Out of Specification: Like High Out of Specification, but for measured temperature lower than the Low-Out-of-Specification value.
- Hysteresis: In order to avoid flickering of diagnostics, a hysteresis value can be configured.
- Unit: Select the unit for temperature measurement.

7.3 Output Configuration

The outputs use the following I/O logic:

Relay contact output 1, Relay contact output 2	0 = relay open 1 = relay closed
Buzzer	0 = Buzzer Off 1 = Buzzer On
Common alarm output	0 = Contact closed 1 = Contact Open

The relay contact output 1, relay contact output 2, common alarm output, and the buzzer can be configured the following way:

- Invert: The output as described in the table above.
- Output source: This configures the value used to control the output. The following options exist:

- Not connected:
The output is not used
- FF channel:
The output is directly controller using an FF function block. This option is only available for the FF integration
- Binary input *:
The output is directly controlled by a binary input. Any of the binary inputs 1 ... 8 can be used. For example, you can turn on a relay if a binary input is activated.
- On/Off controller *:
The output of 1 of the 4 On/Off controllers is used. Each On/Off controller can be assigned to any output.
- Field diagnostics:
If a specified field diagnostic value is set (or reset), the output is activated. This can be used to activate an output if any Maintenance-Required condition (or worse) is active for the device. Since all inputs and the ADM conditions can be mapped to field diagnostics, the common alarm output can summarize all cabinet or ADM issues detected. The table below shows how to use this behavior.

Field Diagnostics Functions

FD Check function	If for any check function Maintenance Required, Out of Specification, or Failure condition is active at the field diagnostics, the output is activated.
FD Check function (inverted)	If for any check function Maintenance Required, Out of Specification, or Failure condition is active at the field diagnostics, the output is deactivated.
FD Maintenance Required	If for any check function Maintenance Required, Out of Specification, or Failure condition is active at the field diagnostics, the output is activated.
FD Maintenance Required (inverted)	If for any check function Maintenance Required, Out of Specification, or Failure condition is active at the field diagnostics, the output is deactivated.
FD Out of Specification	If for any check function Out of Specification or Failure condition is active at the field diagnostics, the output is activated.
FD Out of Specification (inverted)	If for any check function Out of Specification or Failure condition is active at the field diagnostics, the output is deactivated.
FD Failure	If for any check function Failure condition is active at the field diagnostics, the output is activated.
FD Failure (inverted)	If for any check function Failure condition is active at the field diagnostics, the output is deactivated.

The buzzer on the motherboard provides an additional configuration option:

- Frequency: Specifies the buzzing interval for the buzzer. Available options are: 0.5 Hz, 1 Hz, 1.5 Hz, 2 Hz and "Permanently on". If activated, the buzzer modulates its output with the frequency selected.

7.4 On/Off Controllers

The On/Off controllers can be used to control the discrete outputs based on analog input values, such as temperature. Thus, On/Off controller can be used to replace a thermostat for heating or cooling control. The following configuration options are available:

2020-11

- Input: A selector for an analog input value. Available options are:
 - Temperature input 1
 - Temperature input 2
 - Temperature input 2 - temperature input 1 (temperature difference)
 - Motherboard temperature
 - Motherboard humidity
 - Frequency input 1
 - Frequency input 2
- Invert: Inverts the output value.
- On Level: If the input value exceeds this value, the output is set to "1".
- Off Level: If the input value falls below this value, the output is set to "0".

The start value of the output is "0".



Note

Default Values

The default values for the on level and off level inputs are '<<<' for low infinity and '>>>' for high infinite.



Note

Temperature Difference

When using the temperature difference input, the same temperature unit must be configured for the temperature inputs 1 and 2.

7.5

FF Channels for the I/O Transducer Block

The following FF channels can be used to map I/O data to function blocks:

- 101: Input value of binary inputs 1 ... 8 (multiple digital input (MDI) function blocks)
- 102: 1 ... 4 result values of on/off controllers 1 ... 4 (MDI function blocks)
- 103: Value of temperature, humidity, and frequency inputs (multiple analog input (MAI) function block)
- 104: Output values for relay contact outputs, common alarm output, and buzzer. Note that the source of the outputs must be set to "FF channel" (multiple digital output (MDO) function block)
- 105: Value of binary inputs as bits of a U8 value (multiple digital input (MDI) and digital input (DI) function blocks)
- 201: Field diagnostics status value (DI function block), see chapter 6.3

For more information on FF channels, see chapter 8.3.

7.6

Cabinet Management Applications and I/O Blocks

This chapter describes typical cabinet management applications and how to configure their I/O transducer blocks. If the DTM is used, this can be done in a comfortable way. The tab I/O Blocks allows you to select preconfigured applications. These blocks can be adjusted by selecting the inputs and outputs used. Otherwise, most of the configuration takes place automatically.

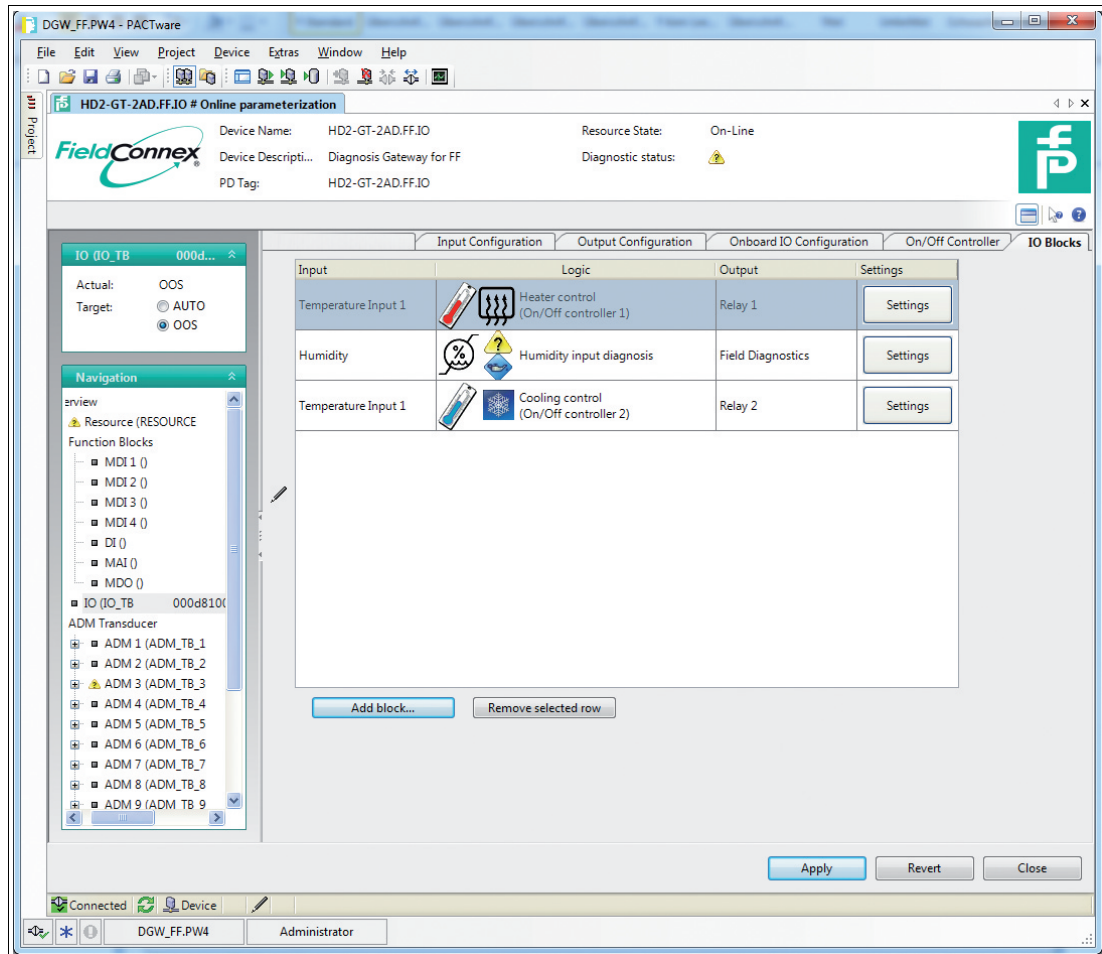

7.6.1 Configuring Typical Cabinet Management Applications Manually

Using Cooling Control

1. Select an unused relay contact output and connect a cooling device (e.g., ventilator) to it.
2. Select an unused on/off controller and configure it as follows:
Options: Not inverted
On level: Temperature level at which the output is supposed to be switched ON.
Off level: Temperature level at which the output is supposed to be switched OFF.
Input selection: Select the temperature input to be used as reference temperature.
3. Configure the output source of the selected relay contact output to the selected on/off controller.
4. Configure measurement unit of selected temperature input.

Using Heater Control

1. Select an unused relay output and connect a heater device to it.

2. Select an unused on/off controller and configure it as follows:
Options: Invert
On level: Temperature level at which the output is supposed to be switched OFF (Note: Inverted output!)
Off level: Temperature level at which the output is supposed to be switched ON (Note: Inverted output!)
Input selection: Select the temperature input to be used as reference temperature.
3. Configure the output source of the selected relay contact output to the selected on/off controller.
4. Configure measurement unit of selected temperature input.



Using Frequency Diagnostics (Ventilator Speed Control)

1. Select an unused frequency input and configure it as follows:
Frequency input: Enable, i.e., set input to frequency mode.
Option: Enable or disable NAMUR lead breakage and short circuit detection as required.
2. Configure the High-/Low- Out-of-Specification and Maintenance-Required limits.
3. Configure the field diagnostics alarms in the resource block.



Monitoring Ambient Conditions (Humidity/Temperature)

In order to enable the field diagnostics alarms for ambient conditions, configure the required High-/Low- Out-of-Specification and Maintenance-Required limits of the board sensors.



Using Binary Input Diagnostics (Cabinet Door Monitoring, Bulk Power Supply Failure Monitoring)

1. Select an unused binary input and configure it as follows:
Options: Enable or disable NAMUR lead breakage and short circuit detection as required.
Binary options: Enable **Invert** if required.
2. Check the corresponding flag in "FD Binary OOS Map" or "FD Binary MR Map". When the input is "1", the selected field diagnostics condition is triggered.
3. Configure the field diagnostics alarms in the resource block.



Mapping of Field Diagnostics to Common Alarm Output (Volt-Free Contact)



Note

The common alarm output is a volt-free contact that is designed to be used as an alarm contact. The normal state ("OFF") is CLOSED.

Note that the ALM LED of the device is connected to the common alarm output. When the output is closed, the LED flashes.

Select the required field diagnostics condition as an output source for the common alarm output.

Two mapping examples help to illustrate how it works:

- FD Out of Specification: If field diagnostics reports an Out-of-Specification alarm or worse (Failure alarm), the output is OPEN.
- FD Check: If field diagnostics reports a check-function alarm or worse (Failure, Out-of-Specification, Maintenance-Required alarms), the output is OPEN.

8 Appendix

8.1 Measured Values / Parameters

8.1.1 Board Type

Board Type Detection

The type of the board on which the HD2-DM-A is installed is detected.

Board Redundancy Detection

Detects whether the HD2-DM-A is installed on a redundant board or not.

8.1.2 Communication Active

Communication activity is detected if any valid frames (Preamble, SOF, EOF) are detected. Loss of communication is detected if no valid signal is recognized for at least 4 seconds.

8.1.3 Current

The current supplied to the segment is measured.

Type	Values
Precision	+/- 5%
Measuring range	0 ... 6.5 A (depends on the motherboard)

8.1.4 Unbalance

The parameter detects unbalance between signal wire and ground (shield). This measurement signals an earth unbalance. This is the case if a segment that belongs to the same isolation group has a DC earth unbalance, e. g., a short circuit from a signal line to shield.

Type	Values
Precision	1%
Measuring range	-100% (short against - wire) to +100% (short against + wire)

Definition

Unbalance is the result of a capacitive or resistive connection between the fieldbus signal wires and ground (cable shield).

Possible Causes

Miswiring/incorrect installation → see Figure 8.1 on page 145:

In the installation scenario illustrated below, several devices are installed incorrectly. On each of the independent segments, one device is wired with the negative data line tied to the shield while the shield is tied to earth ground.

Device influence: In order to increase electromagnetic compatibility stability, some plants modify their fieldbus devices with asymmetric capacitive connections between shield and their + or - fieldbus line. If such fieldbus devices are connected to the plant, they influence the balance of the specific field device or the entire segment.

Wire damage: A wire damaged through external influences can also cause unbalance if there is a short circuit between a fieldbus line and the cable shield.

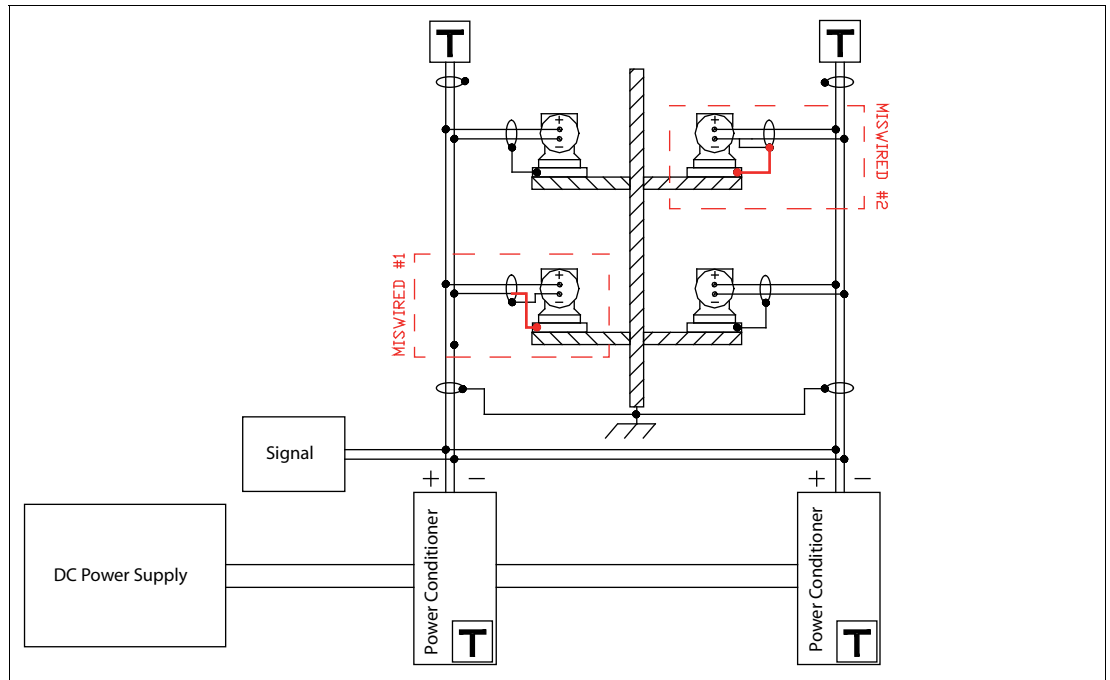

Figure 8.1 Fault wiring DC unbalance

An undetected unbalance can cause communication issues and a lack of electromagnetic compatibility stability.



Note

A single pole-to-shield fault is not critical. But if a second pole-to-shield-fault happens at the same time, corruption of the communication signal and high crosstalk levels can occur between the 2 affected segments.

8.1.5 Active Field Devices

The number and addresses of the currently active field devices are analyzed. Any difference to the time of commissioning is evaluated and reported.

8.1.6 Communication Error Statistics

Parameters for segment and field-device-specific error counters, e.g., CRC errors, framing errors, the number of FF-H1 tokens the device missed. etc.

The number of missed H1 tokens is only updated if the DTM is opened and the segment is selected.

8.1.7 History Recording

Segment and field-device-specific physical layer values are stored with a timestamp of up to 2 years in the advanced diagnostic module for trend analyses.

8.1.8 Jitter

Definition

Jitter is the deviation from the ideal timing of an event. In this case, it is the deviation from the ideal zero crossing point of the transmitted signal curve during the nominal bit duration, measured in relation to the previous zero crossing (reference event).

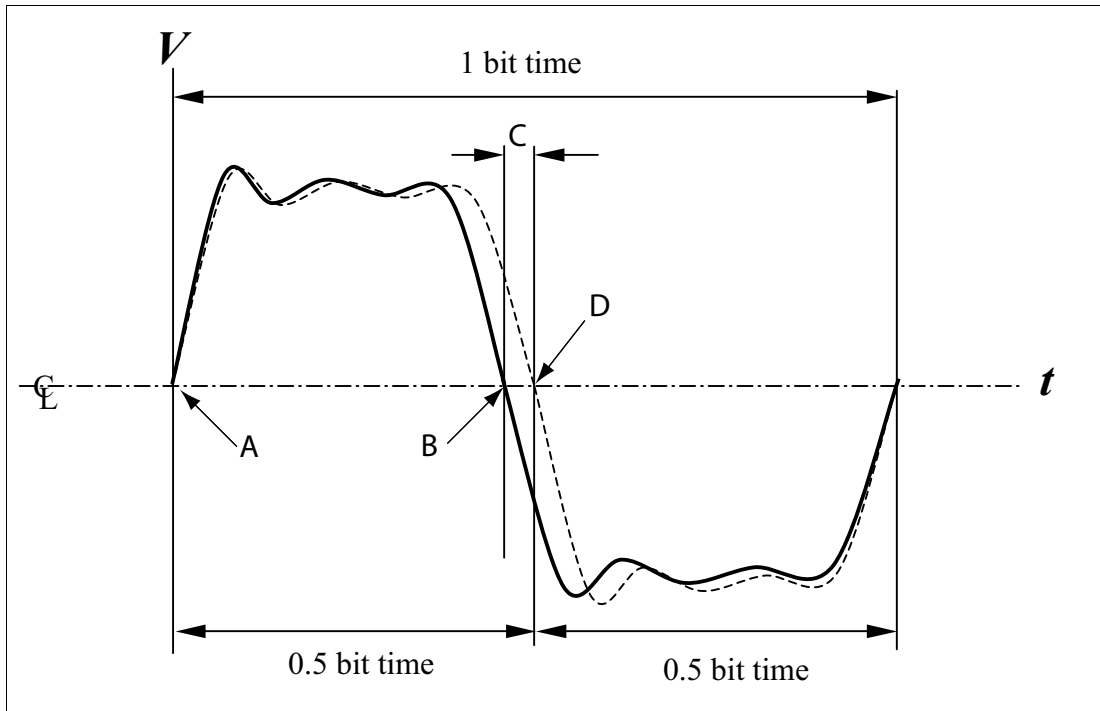

Figure 8.2 Bit cell jitter

- A** Reference event; first zero crossing point
- B** Actual zero crossing point
- C** Bit cell jitter, deviation from the ideal timing
- D** Ideal zero crossing point

Segment or Field Device Jitter

This parameter monitors the current maximum jitter of all active devices connected to the segment. The H1 jitter level is a value derived from the device jitter values. Due to noise levels caused by additional effects, the diagnostic device indicates a first warning at 75 % (2.4 μs) of the maximum allowable jitter level. This is an empiric value that can be modified according to your requirements. If the jitter level exceeds 3.2 μs , a final warning is issued.

Type	Values
Precision	0.1 μs
Measuring range	0 μs ... 8 μs

The segment jitter is the maximum value of all device jitter values. A high jitter level causes communication problems and a lack of operational reliability. The transmitted bit cell jitter cannot exceed 10 % of 1-bit time. E. g., at 31.25 kbits/s the duration of 1-bit time is 32 μs . Thus, the maximum bit cell jitter cannot exceed 3.2 μs . Your system can run at a higher jitter level, but at the expense of a reduced level of immunity against influences on electromagnetic compatibility.

Jitter can have the following causes:

- Crosstalk
- Electromagnetic interferences (EMI)
- Simultaneous switching outputs
- Device dependency
- Bad wiring practice

8.1.9 Noise

Definition

Noise is an undesired disturbance within the signal frequency band. Noise appears with different characteristics. A high noise level causes communication problems and a lack of operational reliability. Segment noise is the maximum noise of all field device noise or the noise measured if no field device is communicating. The field device noise is measured just before a field device is transmitting. That does not mean that this device is causing any noise. Measurement takes place to determine whether the noise value is high for a single field device only. Often, this means that noise is caused by the device that has been transmitting right before the device that shows the increased noise. The HD2-GT-2AD.FF.IO FF-H1 field device does not support noise measurement per device.

Noise can have the following causes:

- Bad wiring practice
- Bad shielding/grounding practice
- Supply voltage noise pulses passed onto the bus by a non-regulated power supply
- An AC power supply injects noise into the bus
- A regulated FOUNDATION Fieldbus power supply injects switching noise into the bus

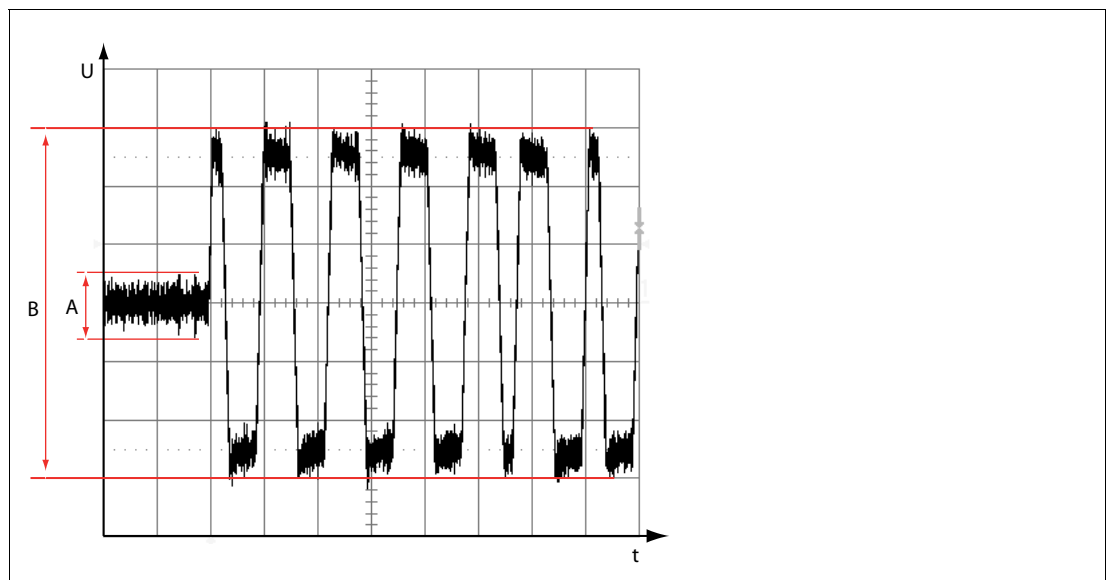

Figure 8.3 Communication noise

- A** Noise level
- B** Signal level

Type	Values
Precision	10 mV
Measuring range	0 ... 2.5 V, 100 Hz ... 140 kHz

8.1.10 Polarity

This parameter detects the polarity of the communication signal for every field device.

8.1.11 Power Supply Voltage

This parameter indicates the voltage level of the primary and secondary bulk power.

Type	Value
Precision	+/- 5%
Measuring range	0 ... 40 V

8.1.12 Signal Level

The current peak-to-peak signal level of all field devices is measured and shown for each field device, as well as the current maximum and minimum value for the segment.

Type	Values
Precision	+/- 10 mV
Conforming standards value	150 mV ... 375 mV

8.1.13 Trunk Surge Protector Alarm

Diagnostics detect and report the end of effective life signals from FieldConnex[®] trunk surge protectors.

8.1.14 Device Coupler Alarms

Diagnostics detect and report Maintenance Required and Out of Specification alarms from FieldConnex[®] device couplers. This includes the diagnostic information of the following devices:

- Device coupler diagnostics
- Surge protector alarms
- Enclosure leakage sensor alarms

8.1.15 Voltage

H1 Segment Voltage

The voltage at the segment input of the advanced diagnostic module is measured.

Type	Values
Precision	+/- 5 %
Measuring range	0 ... 40 V

8.1.16 Measured Values by Motherboard Type

Values	MB* - Motherboard	MB-FB-DMA	DART
Bulk power supply	x	x	x
Board type detection	x	x	x
Board redundancy detection	x		x
Power supply module type and failure detection	x		x
Voltage	x	x	
Current	x		
Communication active	x	x	x
Segment/field device noise	x	x	x
Segment/field device jitter	x	x	x

2020-11

Values	MB* - Mother-board	MB-FB-DMA	DART
Active field devices	x	x	x
Unbalance	x	x	
Communication errors statistic	x	x	x
Field device polarity	x	x	x
Signal level	x	x	x
Trunk surge protector alarm	x		
Device coupler alarm	x	x	

8.2 HD2-GT-2AD.FF.IO FF Blocks

The column "Char." shows which characteristics or conditions are applicable to this parameter.

- OOS (Out of Service): The parameter can be written only if the target mode of the block is "Out of Service".
- S (Static): During each writing process to a parameter of this type, the parameter ST_REV is increased by 1.
- W (Writeable): The parameter can be modified by the user.

Since all parameters can be read, this is not marked in a special way.

8.2.1 ADM_TB Transducer Block

Parameters

Parameter	Char.	Description
ST_REV	S	During each writing process to a parameter marked by "S" the parameter ST_REV is increased by 1.
TAG_DESC	S, W	An additional description to the tag of the field device.
STRATEGY	S, W	The strategy field can be used to identify comprising blocks. This data is not controlled or used by the block.
ALERT_KEY	S, W	Identification number of the plant component. This information can be used by the control computer, e.g., to sort alarms. Valid values are 1 ... 65536.
MODE_BLK	S, W	Displays the current, permitted standard mode and the target mode of the block. The target mode can be set to the values "Auto" or "Out of Service". Default: Auto
BLOCK_ERR		<ul style="list-style-type: none"> • Out of Service: The actual block mode is OOS. • Block configuration error: Check all segment expert system messages for information on configuration error cause. • Other: The status of any ADM segment is not "good", "no error", "excellent" or "segment disabled".
UPDATE_EVT		This parameter is used to signal to the PCS that a parameter marked with "S" was overwritten, provided the PCS supports alarm messages.
BLOCK_ALM		This parameter is used to signal to the PCS diagnostic messages displayed in BLOCK_ERR, provided the PCS supports alarm messages.
XD_STATUS	Record	SYSTEM STATUS: Status of the ADM system (bulk power supply voltage).
		SEGMENT_* STATUS: Summary value of segment quality.

Parameter	Char.	Description
SYSTEM	Record, S, W, OOS	HISTORY_PERIOD: History period of the ADM. Controls the number of times the ADM writes a history entry to its non-volatile memory. History can be read via DTM function "History export".
		FLASH_LEDS: Causes the ADM device to have all LEDs flashing for identification purpose.
SYSTEM_DYNAMIC	Record	ADM_SERIAL_NUMBER: Serial number of the attached ADM.
		ADM_SOFTWARE_REVISION: Software version of attached ADM.
		ADM_PROTOCOL_REVISION: Internal usage
		ADM_EXPERT_REVISION: Internal usage
		BOARD_TYPE: Motherboard type the ADM is mounted on.
		U_PWR_HI_HI_OOS: Bulk power supply High-Out-of-Specification limit.
		U_PWR_LO_LO_OOS: Bulk power supply Low-Out-of-Specification limit.
		U_PWR_PRI: Actual measured value of primary bulk power supply voltage.
		U_PWR_SEC: Actual measured value of secondary bulk power supply voltage (not available on some motherboards).
		SYSTEM_ALARMS: List of active system alarms: <ul style="list-style-type: none"> • Primary power supply high Out of Specification • Primary power supply low Out of Specification • Secondary power supply high Out of Specification • Secondary power supply low Out of Specification
All segment parameters exist 4x, once for each ADM segment. X = 1 ... 4		
EXPERT_SYSTEM(X)	Record, W	RESET_INACTIVE: Clears inactive messages
		OVERALL_STATUS: Overall segment diagnostic quality. Possible values: are <ul style="list-style-type: none"> • No Error (commissioned) • Maintenance Required (commissioned) • Out of Specification (commissioned) • Excellent (non-commissioned) • Good (non-commissioned) • Out of Specification (non-commissioned) • Fail (ADM hardware error) • Configuration Error (see expert messages for information) • No corresponding ADM connected • Segment is disabled
		5x expert diagnostic messages consisting of "Active" flag and the actual message. N = 1 ... 5
		ACTIVE(N): Following expert message is active (the error is present) or inactive (the error is gone).

Parameter	Char.	Description
		EXPERT MSG_(N): Expert message. For detailed explanation, .
SEG- MENT_(X)_S TATIC	Record, W, S, OOS	H1_TAG: Segment tag
		H1_MODE: Segment mode <ul style="list-style-type: none"> • Disabled • Non commissioned (default) • Commissioned
		PS_MODULE_SUPERVISION: Enables diagnostics of power supply modules. If enabled, segment power supply errors are reported (module missing, module failure). <ul style="list-style-type: none"> • Supervise power supply A. • Supervise power supply B (on redundant boards).
		H1_U_HI_HI_OOS: Enable or disable segment voltage High-Out-of-Specification limit.
		H1_U_HI_MR: Segment voltage high maintenance required limit. <ul style="list-style-type: none"> • 0: Disabled • 9 ... 32 V: Enabled
		H1_U_LO_MR: Segment voltage Low-Maintenance-Required limit. <ul style="list-style-type: none"> • 0: Disabled • 9 ... 32 V: Enabled
		H1_U_LO_LO_OOS: Enable or disable segment voltage Low-Out-of-Specification limit.
		H1_I_HI_MR: Segment current High-Maintenance-Required limit. <ul style="list-style-type: none"> • 0: Disabled • 1 ... 6500 mA: Enabled
		H1_I_LO_MR: Segment current Low-Maintenance-Required limit. <ul style="list-style-type: none"> • 0: Disabled • 1 ... 6500 mA: Enabled
		H1_UNBALANCE_HI_HI_OOS: Enable or disable segment unbalance High-Out-of-Specification limit.
		H1_UNBALANCE_HI_MR: Segment unbalance High-Maintenance-Required limit. <ul style="list-style-type: none"> • 0: Disabled • -100% ... 100%: Enabled
		H1_UNBALANCE_LO_MR: Segment unbalance Low-Maintenance-Required limit. <ul style="list-style-type: none"> • 0: Disabled • -100% ... 100%: Enabled
		H1_UNBALANCE_LO_LO_OOS: Enable or disable segment unbalance Low-Out-of-Specification limit.
		H1_SIGNAL_LEVEL_HI_HI_OOS: Enable or disable segment maximum signal level High-Out-of-Specification limit.

Parameter	Char.	Description
		H1_SIGNAL_LEVEL_HI_MR: Segment maximum signal level High-Maintenance-Required limit. <ul style="list-style-type: none"> 0 mV: Disabled 100 mV ... 2200 mV: Enabled
		H1_SIGNAL_LEVEL_LO_MR: Segment minimum signal level Low-Maintenance-Required limit. <ul style="list-style-type: none"> 0 mV: Disabled 100 mV ... 2200 mV: Enabled
		H1_SIGNAL_LEVEL_LO_LO_OOS: Enable or disable segment minimum signal level Low-Out-of-Specification limit.
		H1_NOISE_HI_HI_OOS: Enable or disable segment noise level High-Out-of-Specification limit.
		H1_NOISE_HI_MR: Segment noise level low maintenance required limit: <ul style="list-style-type: none"> 0 mV: Disabled 25 mV ... 1000 mV: Enabled
		H1_JITTER_HI_HI_OOS: Enable or disable segment jitter level High-Out-of-Specification limit.
		H1_JITTER_HI_MR: Segment jitter High-Maintenance-Required limit: <ul style="list-style-type: none"> 0 µS: Disabled 0.5 ... 7 µS: Enabled
		H1_TRUNK_ALARM: Enable or disable trunk surge protector alarm.
		IGNORE_TOPOLOGY_SETTINGS: Ignore or use the following topology settings.
		POWERSUPPLY_TYPE: Segment power supply type.
		COUPLER_TYPE: Device coupler type used on segment.
		COUPLER_COUNT: Number of device couplers on segment.
		TRUNK_LENGTH: Segment trunk length.
		TRUNK_CABLE_TYPE: Segment trunk type.
		TOPO_OPTIONS: Topology options: <ul style="list-style-type: none"> Enable or disable monitoring of surge protector status.
SEG- MENT(X)_D YNAMIC	Record	H1_COMMUNICATION_ACTIVE: Communication is detected on segment.
		H1_NUM_ACTIVE_DEVICES: Number of detected field devices.
		H1_U: Segment voltage
		H1_I: Segment current (not available on some motherboards).

Parameter	Char.	Description
		H1_UNBALANCE: Segment unbalance (not available on some motherboards).
		H1_SIGNAL_LEVEL_MAX: Maximum field device signal level.
		H1_SIGNAL_LEVEL_MIN: Minimum field device signal level.
		H1_NOISE: Segment noise
		H1_JITTER: Maximum field device jitter.
		H1_SEGMENT_ALARMS: List of segment errors in commissioned mode: <ul style="list-style-type: none"> • Power supply A Out of Specification • Power supply B Out of Specification • Segment voltage high Out of Specification • Segment voltage high Maintenance Required • Segment voltage low Maintenance Required • Segment voltage low Out of Specification • Segment current high Maintenance Required • Segment current low Maintenance Required • Unbalance high Out of Specification • Unbalance high Maintenance Required • Unbalance low Maintenance Required • Unbalance low Out of Specification • Signal level high Out of Specification • Signal level high Maintenance Required • Signal level low Maintenance Required • Signal level low Out of Specification • Noise high Out of Specification • Noise high Maintenance Required • Jitter high Out of Specification • Jitter high Maintenance Required • Inactive configured device • Unconfigured active/field devices • Trunk surge protector alarm

Parameter	Char.	Description
		<p>H1_SEGMENT_NONCOM_STATUS: List of segment errors in non-commissioned mode:</p> <ul style="list-style-type: none"> • Power supply A error • Power supply B error • Segment voltage high Out of Specification • Segment voltage high Good • Segment voltage low Good • Segment voltage low Out of Specification • Segment current high Good • Unbalance high Out of Specification • Unbalance high Good • Unbalance low Good • Unbalance low Out of Specification • Signal level high Out of Specification • Signal level high Good • Signal level low Good • Signal level low Out of Specification • Noise high Out of Specification • Noise high Good • Jitter high Out of Specification • Jitter high Good • Trunk surge protector alarm
		<p>H1_ERROR_RATE_ACT: Error rate in actual history period – number of errors per frames received.</p>
		<p>H1_ERROR_RATE_LAST: Error rate in previous history period – number of errors per frames received</p>
<p>Configuration data of nodes. The record is used 6 times (Z=1..6), 18 nodes are configurable (Y=1-18)</p>		
<p>SEG- MENT_(X)_D EV_STAT- IC_ DATA_(Z) Z= 1_3 4_6 7_9 10_12 13_15 16_18</p>	<p>Record, W, S, OOS</p>	<p>DEVICE_(Y)_ADDRESS: Field device address:</p> <ul style="list-style-type: none"> • 0: Entry is not used (default) • 1 ... 254: Entry is used
		<p>DEVICE_(Y)_TAG: Field device tag</p>
		<p>DEVICE_(Y)_SIGNAL_LEVEL_HI_HI_OOS: Enable or disable segment maximum signal level High-Out-of-Specification limit</p>
		<p>DEVICE_(Y)_SIGNAL_LEVEL_HI_MR: Segment maximum signal level High-Maintenance-Required limit</p> <ul style="list-style-type: none"> • 0 mV: Disabled • 100 mV ... 2200 mV: Enabled

Parameter	Char.	Description
		DEVICE_(Y)_SIGNAL_LEVEL_LO_MR: Segment maximum signal level Low-Maintenance-Required limit <ul style="list-style-type: none"> • 0 mV: Disabled • 100 mV ... 2200 mV: Enabled
		DEVICE_(Y)_SIGNAL_LEVEL_LO_LO_OOS: Enable or disable segment maximum signal level Low-Out-of-Specification limit
		DEVICE_(Y)_COUPLER_ERROR: Enable or disable device coupler OOS and MR diagnostics
Actual measurement data of active configured nodes on bus. Y = 1 ... 18		
SEGMENT_(X)_DEVICE_DYNAMIC_DATA_1_9	Record	DEVICE_(Y)_ADDRESS: Field device address: <ul style="list-style-type: none"> • 0: Node not available on segment • Other: Node is active
		DEVICE_(Y)_STATUS: Field device status information <ul style="list-style-type: none"> • Device is inactive • Inverse polarity • Active • Device coupler status Good • Device coupler status Maintenance Required • Device coupler status Out of Specification • Signal level high Out of Specification • Signal level high Maintenance Required • Signal level low Maintenance Required • Signal level low Out of Specification • Device is LAS
		DEVICE_(Y)_SIGNAL_LEVEL: Measured signal level
		DEVICE_(Y)_JITTER_LEVEL: Measured jitter level
SEGMENT_(X)_DEVICE_DYNAMIC_DATA_10_18	Record	Same as SEGMENT_(X)_DEVICE_DYNAMIC_DATA_1_9 but nodes 10 ... 18
Actual measurement data of active unconfigured nodes on bus. Y = 1 ... 18		
SEGMENT_(X)_UNCONFIGURED_DEVICE_DYNAMIC_DATA_1_9	Record	UNCF_DEVICE_(Y)_ADDRESS: Field device address: <ul style="list-style-type: none"> • 0: Node not available on segment • Other: Node is active

Parameter	Char.	Description
		UNCF_DEVICE (Y) STATUS: Field device status information <ul style="list-style-type: none"> • Device is inactive • Inverse polarity • Device is active • Device coupler status Good • Device coupler status Out of Specification • Signal level high Out of Specification • Signal level high Good • Signal level low Good • Signal level low Out of Specification • Device is LAS
		UNCF_DEVICE (Y) SIGNAL_LEVEL: Measured signal level
		UNCF_DEVICE (Y) JITTER_LEVEL: Measured jitter level
SEGMENT (X) UNCONF_DEVICE_DATA_10_18	Record	Same as SEGMENT (X) UNCONF_DEVICE_DATA_1_9, but nodes 10 ... 18
COMMISSIONING_WIZARD	Record, W	COMMISSIONING_CMD: For internal use
		COMMISSIONING_PROGRESS: For internal use
		COMMISSIONING_STATUS: For internal use
		TAGIMPORT_STATE: For internal use
		TAGIMPORT_PROGRESS: For internal use

Methods

- Identify ADM: Causes the ADM to have all LEDs flashing for identification purpose.
- Commissioning wizard: Graphical wizard to perform commissioning of the segment. See chapter 6.8.2
- Commissioning wizard (simple): Simple wizard to commission a segment in systems that do not support EDDL features that wizards use.
- Tag import (simple): Simple tag import function for systems that do not support EDDL features that wizards use.
- Firmware update: Updates the ADM to the firmware built into HD2-GT-2AD.FF.IO device. Only 1 ADM can be updated at a time, check the expert diagnostic messages in the diagnostics segment interfaces for the update status.

8.2.2 Transducer Block IO_TB

Parameters

Parameter	Char.	Description
ST_REV	S	During each writing process to a parameter marked with "S", the parameter ST_REV is increased by 1.
TAG_DESC	S, W	An additional description of the tag of the field device.

2020-11

Parameter	Char.	Description
STRATEGY	S, W	The strategy field can be used to identify comprising blocks. This data is not controlled or used by the block.
ALERT_KEY	S, W	Identification number of the plant component. This information can be used by the control computer, e.g., to sort alarms. Valid values are 1 ... 65536.
MODE_BLK	S, W	Displays the current, permitted standard mode and the target mode of the block. The target mode can be set to the values "Auto" or "Out of Service". Default: Auto
BLOCK_ERR		<ul style="list-style-type: none"> • Out of service: When actual block mode is OOS • Block configuration error: <ul style="list-style-type: none"> - Turn_On value of an on/off controller is lower than Turn_Off value - Maintenance Required or Out of Specification limits of temperature, humidity, or frequency inputs not consistent - On/off controller has input temperature difference and different units are selected for temperature input 1 and 2 • Other: If XD_ERROR is not zero • Sensor failure detected: If any bit in BINARY_ERRORS or ANALOG_ERRORS is set
UPDATE_EVT		This parameter is used to signal to the PCS that a parameter marked with "S" was overwritten provided that the PCS supports alarm messages.
BLOCK_ALM		This parameter is used to signal to the PCS diagnostic messages displayed in BLOCK_ERR, provided that the PCS supports alarm messages.
XD_ERROR		Summary Field diagnostics status of the block: <ul style="list-style-type: none"> • Out of specification • Maintenance required
BINARY_ERRORS		Leadbreakage or short circuit detection diagnostic information of binary inputs.
ANALOG_ERRORS		Failure information of analog inputs <ul style="list-style-type: none"> • Temperature input 1 and 2 • Board temperature input • Board humidity input • Frequency input 1 and 2
FD_MR_ACTIVE		Field diagnostics Maintenance Required error active for either of the following: <ul style="list-style-type: none"> • Binary input 1 ... 8 • Temperature input 1 and 2 • Board temperature input • Board humidity input • Frequency input 1 and 2
FD_OOS_ACTIVE		See FD_MR_ACTIVE, but for Out-of-Specification status
BINARY_INPUT_X (1-8)		Binary input X value and status
TEMP_INPUT_X (1-2)		Temperature input X value and status
TEMP_INPUT_INT		Board temperature value and status

Parameter	Char.	Description
HUMIDITY_INPUT_INT		Board humidity value and status
FREQ_INPUT_X (1-2)		Frequency input X value and status
RELAY_OUTPUT_X (1-2)		Output value and status of relay output: <ul style="list-style-type: none"> 0: Relay is off (open) 1: Relay is on (closed)
BUZZER_OUTPUT		Output value and status of buzzer: <ul style="list-style-type: none"> 0: Buzzer is off 1: Buzzer is active
COMMON_ALARM_OUTPUT		Output value and status of common alarm output. This is a failure output, so "on" means "open": <ol style="list-style-type: none"> 0: Common alarm output is closed 1: Common alarm output is open
ON_OFF_CONTROLLER_X (1-4)		Output value and status of on/off controller
FD_BINARY_OOS_MAP	W, S, OOS	When activated, a value of "1" of the corresponding binary input triggers a field diagnostics IO_TB-Out-of-Specification condition.
FD_BINARY_MR_MAP	W, S, OOS	When activated, a value of "1" of the corresponding binary input triggers a field diagnostics IO_TB-Maintenance-Required condition.
BINARY_INPUT_1_SETTINGS/BINARY_INPUT_2_SETTINGS	Record, W, S, OOS	TAG Tag of the input
		OPTIONS <ul style="list-style-type: none"> Enable or disable lead breakage detection Enable or disable short circuit detection Use input as frequency input instead of binary input Invert (binary mode only) Use Fault state (binary mode only) Fault state to value (binary mode only) Fault state (binary mode only)
		HI HI_OOS Field diagnostics High-Out-of-Specification frequency limit (frequency mode)
		HI MR Field diagnostics High-Maintenance-Required frequency limit (frequency mode)
		LO MR Field diagnostics Low-Maintenance-Required frequency limit (frequency mode)
		LO LO_OOS Field diagnostics Low-Out-of-Specification frequency limit (frequency mode)
		HYSTERESIS Diagnostics hysteresis in order to avoid alarm flickering (frequency mode).

Parameter	Char.	Description
BINARY_IN- PUT_3_SET- TINGS/ BINARY_IN- PUT_4_SET- TINGS/ BINARY_IN- PUT_5_SET- TINGS/ BINARY_IN- PUT_6_SET- TINGS/	Record, W, S, OOS	TAG Tag of the input. OPTIONS <ul style="list-style-type: none"> • Enable or disable lead breakage detection. • Enable or disable short circuit detection. • Invert (binary mode only) • Use Fault state (binary mode only). • Fault state to value (binary mode only). • Fault state (binary mode only).
TEMP_IN- PUT_1_SET- TINGS/ TEMP_IN- PUT_2_SET- TINGS	Record, W, S, OOS	TAG Tag of the input. OPTIONS <ul style="list-style-type: none"> • Enable or disable lead breakage detection (binary mode only) • Enable or disable short circuit detection (binary mode only) • Use input as binary Input • Invert (binary mode only) • Use Fault state (binary mode only) • Fault state to value (binary mode only) • Fault state (binary mode only) UNIT Temperature unit. Supported units: °C, °F, °R, K HI HI OOS Field diagnostics High-Out-of-Specification temperature limit (temperature mode) HI MR Field diagnostics High-Maintenance-Required temperature limit (temperature mode) LO MR Field diagnostics Low-Maintenance-Required temperature limit (temperature mode) LO LO OOS Field diagnostics Low-Out-of-Specification temperature limit (temperature mode) HYSTERESIS Diagnostic hysteresis in order to avoid alarm flickering (temperature mode).
TEMP_INT - SETTINGS	Record, W, S, OOS	UNIT Temperature unit. Supported units: °C, °F, °R, K HI HI OOS Field diagnostics High-Out-of-Specification temperature limit HI MR Field diagnostics High-Maintenance-Required temperature limit LO MR Field diagnostics Low-Maintenance-Required temperature limit LO LO OOS Field diagnostics Low-Out-of-Specification temperature limit HYSTERESIS Diagnostic hysteresis to avoid alarm flickering

2020-11

Parameter	Char.	Description
HUMIDITY_INPUT_SETTINGS	Record, W, S, OOS	HI HI OOS Field diagnostics High-Out-of-Specification humidity limit
		HI MR Field diagnostics High-Maintenance-Required humidity limit
		LO MR Field diagnostics Low-Maintenance-Required humidity limit
		LO LO OOS Field diagnostics Low-Out-of-Specification humidity limit
		HYSTERESIS Diagnostic hysteresis in order to avoid alarm flickering
BUZZER_SETTINGS	Record, W, S, OOS	Frequency Buzzer interval: <ul style="list-style-type: none"> • 0.5 Hz • 1.0 Hz (default) • 1.5 Hz • 2.0 Hz • Permanently on
		OPTIONS Invert input value (0: On; 1: Off)
RELAY_OUTPUT_1_SETTINGS/ RELAY_OUTPUT_1_SETTINGS	Record, W, S, OOS	TAG Tag of the output.
		OPTIONS Invert output value (0: On; 1: Off)
COMMON_ALARM_OUTPUT_SETTINGS	W, S, OOS	Invert output value (0: Open; 1: Closed)

Parameter	Char.	Description
OUTPUT _ SOURCE	Record, W, S, OOS	<p>RELAY_OUTPUT_1</p> <ul style="list-style-type: none"> • Not connected: The value of the output is the same as defined if the IO_TB is in OOS mode • FF channel: The output value is provided through an FF channel • BINARY_INPUT_1-8: Binary input 1 ... 8 • ON_OFF_CONT_1-4: On/off controller 1 ... 4 • Field diagnostics Fail: The output is set to 1 if a field diagnostics Fail alarm is active • Field diagnostics Fail Inverted: Same as FD Fail but output value is inverted • Field diagnostics Out of Spec: The output is set to 1 if a field diagnostics Fail or Out of Specification alarm is active • Field diagnostics Out of Spec Inverted: Same as FD Out of Specification but output value is inverted • Field diagnostics MR: : The output is set to 1 if a Field diagnostics Fail, Out of Specification, or Maintenance Required alarm is active • Field diagnostics MR Inverted: Same as FD MR, but output value is inverted • Field diagnostics Check: The output is set to 1 if a field diagnostics Fail, Out of Specification, Maintenance Required, or Check function alarm is active • Field diagnostics Check Inverted: Same as FD Check, but output value is inverted
		<p>RELAY_OUTPUT_2 See RELAY_OUTPUT_1</p>
		<p>BUZZER_OUTPUT See RELAY_OUTPUT_1</p>
		<p>COMMON_ALARM_OUTPUT See RELAY_OUTPUT_1</p>
ON_OFF _ SET- TINGS_1/ ON_OFF _ SET- TINGS_2/ ON_OFF _ SET- TINGS_3/ ON_OFF _ SETTINGS_4	Record, W, S, OOS	<p>INPUT</p> <p>Selects the input value for the on/off controller</p> <ul style="list-style-type: none"> • Temperature input 1 • Temperature input 2 • Temperature difference (Temperature input 2 – temperature input 1) • Motherboard temperature • Motherboard humidity • Frequency input 1 • Frequency input 2
		<p>ON_LEVEL</p> <p>If input value > ON_LEVEL, then output value = 1</p>
		<p>OFF_LEVEL</p> <p>If input value < OFF_LEVEL, then output value = 0</p>
		<p>OPTIONS</p> <p>Invert: Inverts controller output.</p>
SERI- AL_USAGE		For internal usage

Parameter	Char.	Description
IO_BOARD_INF0	Record	BOARD_TYPE Indicates the board type where the diagnostic gateway is mounted on: <ul style="list-style-type: none"> • MB-FB-GT-AD.FF ("Passive board") • MB-FB-GT-AD.FF.IO ("I/O board")
		BOARD_SW_REVISION Software revision of the I/O motherboard (only when mounted on MB-FB-GT-AD.FF.IO)

8.2.3 Multiple Discrete Input (MDI) Function Block

Parameters

Parameter	Char.	Description
ST_REV	S	During each writing process to a parameter marked with "S", the parameter ST_REV is increased by 1.
TAG_DESC	S, W	An additional description to the tag of the field device.
STRATEGY	S, W	The strategy field can be used to identify comprising blocks. This data is not controlled or used by the block.
ALERT_KEY	S, W	Identification number of the plant component. This information can be used by the control computer, e.g., to sort alarms. Valid values are 1 ... 65536.
MODE_BLK	S, W	Displays the current, permitted standard mode and the target mode of the block. The target mode can be set to the values "Auto" or "Out of Service". Default: Auto
BLOCK_ERR		Displays diagnostic messages of the block.
CHANNEL	S, W	The channel parameter is used to logically associate transducer and function block information. During block configuration, the value of the channel number may be configured in input and output function blocks. See chapter 8.3
OUT_D1	W, OOS, MAN	Output value and status. Manual mode permits manual (operator/engineer) substitution of the value of OUT_D, for tests or other purposes.
OUT_D2 – OUT_D8	W, OOS, MAN	See OUT_D1
UPDATE_EVT		This parameter is used to signal to the PCS that a parameter marked with "S" was overwritten, provided the PCSs supports alarm messages.
BLOCK_ALM		This parameter is used to signal to the PCS diagnostic messages displayed in BLOCK_ERR, provided that the PCS supports alarm messages.

8.2.4 Digital input (DI) Function Block

Parameters

Parameter	Char.	Description
ST_REV		During each writing process to a parameter marked with "S", the parameter ST_REV is increased by 1.
TAG_DESC	W, S	Via this parameter, a tag (measuring point designation) can be assigned to the valve interface in the plant or process.
STRATEGY	W, S	The strategy field can be used to identify comprising blocks. This data is not controlled or used by the block.
ALERT_KEY	W, S	Identification number of the plant component. This information can be used by the control PC, e.g., to sort alarms. Valid values are 1 ... 65536.
MODE_BLK	W, S	Displays the current, allowed, normal mode and the target mode of the block. The target mode can be set to the values "Auto", "Man" or "Out of Service".
BLOCK_ERR		Displays diagnostic messages of the block.
PV_D		Channel value with optional inversion (IO_OPTS) and filtering applied to it (PV_FTIME).
OUT_D	W, Man	The actual output value. When the block is in AUTO mode, this is equal to PV_D. If the block is in manual mode, the parameter is writeable.
SIMULATE_D	W, S, OOS	Using this structure, the simulation can be activated or deactivated. If the simulation is activated, this parameter determines FIELD_VAL_D. The simulation can only be activated with the associated switch 1 ON.
XD_STATE	W, S	Used by some PCS to assign texts to the numerical values of FIELD_VAL_D.
GRANT_DENY	W	Depending on the PCS in use, the parameter regulates the access rights between PCS and local operator workstations for some control systems.
IO_OPTS	W, S, OOS	Option which enables the user to adapt the block algorithm to the task of the block. This option is: Invert. PV_D is calculated as follows: A Boolean negation of FIELD_Val_D is carried out i.e., PV_D becomes 1 if FIELD_VAL_D is 0. If FIELD_VAL_D is greater than 0, then PV_D becomes 0.
STATUS_OPTS	W, S, OOS	Option that enables the user to adapt the block status processing to the task of the block. This option is: Propagate Fault Forward. If this option is used, the function block does not trigger an alarm itself if the status of PV_D becomes "Bad". Instead, the status, including substatus, is passed on via OUT_D.
CHANNEL	W, S, OOS	The number of the logical hardware channel that is connected to this I/O block. This information defines the signal converter to be used going to or from the physical world. See chapter 8.3
PV_FTIME	W, S	Time constant of a single exponential filter for the primary variable (PV) in seconds.
FIELD_VAL_D		Raw value of the field device digital input, with a status reflecting the signal converter condition.

Parameter	Char.	Description
UPDATE_EVT		This parameter is used to signal to the PCS that a parameter marked with "S" was overwritten, provided the PCS supports alarm messages.
BLOCK_ALM		This parameter is used to signal diagnostic messages that are displayed in BLOCK_ERR to the PCS, provided the PCS supports alarm messages.
ALARM_SUM		The current status of the alarm messages of the block.
ACK_OPTION	S, W	Determines if alarms of the function block have to be confirmed or not.
DISC_PRI	S, W	Priority of discrete alarm
DISC LIM	S, W	Digital input state, in which an alarm is supposed to be generated.
DISC_ALM	S, W	The current state of the discrete alarm, along with a timestamp and datestamp.

8.2.5 Function Block MAI

Parameters

Parameter	Char.	Description
ST_REV	S	During each writing process to a parameter marked with "S", the parameter ST_REV is increased by 1.
TAG_DESC	S, W	Use this parameter to assign a tag to the valve interface (measuring point designation) in the plant or process.
STRATEGY	S, W	The strategy field can be used to identify comprising blocks. This data is not controlled or used by the block.
ALERT_KEY	S, W	Identification number of the plant component. This information can be used by the control computer, e.g., to sort alarms. Valid values are 1 ... 65536.
MODE_BLK	S, W	Displays the current, allowed normal mode and the target mode of the block. The target mode can be set to the values "Auto" or "Out of Service". Default: Auto
BLOCK_ERR		Displays diagnostic messages of the block.
CHANNEL	S, W	The channel parameter is used to logically associated signal converter and function block information. During block configuration, the value of the channel number can be configured in input and output function blocks. See chapter 8.3
OUT_D1		Output value and status. Manual mode permits the operating personnel or engineer to manually substitute the value of OUT_D, for test or other purposes.
OUT_D2 – OUT_D8		See OUT_D1
UPDATE_EVT		This parameter is used to signal to the PCS that a parameter marked with "S" was overwritten if the PCS supports alarm messages.
BLOCK_ALM		This parameter is used to signal to the PCS diagnostic messages displayed in BLOCK_ERR, if the PCS supports alarm messages.

8.2.6 Function Block MDO

Parameters

Parameter	Char.	Description
ST_REV	S	During each writing process to a parameter marked with "S", the parameter ST_REV is increased by 1.
TAG_DESC	S, W	Use this parameter to assign a tag to the valve interface (measuring point designation) in the plant or process.
STRATEGY	S, W	The strategy field can be used to identify comprising blocks. This data is not controlled or used by the block.
ALERT_KEY	S, W	Identification number of the plant component. This information can be used by the control computer, e.g., to sort alarms. Valid values are 1 ... 65536.
MODE_BLK	S, W	Displays the current permitted standard mode and the target mode of the block. The target mode can be set to the values "Auto" or "Out of Service". Default: Auto
BLOCK_ERR		Displays diagnostic messages of the block.
CHANNEL	S, W	The channel parameter is used to logically associate signal converter and function block information. During block configuration, the value of the channel number can be configured in input and output function blocks. See chapter 8.3
IN_D1		Input value and status.
IN_D2 - IN_D8		See IN_D1
MO_OPTS	S, W	Options that the user can select to alter multiple output block processing.
FSTATE_TIME	S, W	The delay time in seconds. Time from the detection of a condition initiating a fault state action in an output block until the actual initiation of the output action of the block output. That is provided that the condition exists continuously during this time interval as sampled by the output block.
FSTATE_VAL_D1	S, W	The preset discrete value to be used if failure occurs in IN_D1. This value is ignored if the "Fault state to value 1" in the MO_OPTS parameter is false.
FSTATE_VAL_D2 - FSTATE_VAL_D8	S, W	See FSTATE_VAL_D1
UPDATE_EVT		This parameter is used to signal to the PCS that a parameter marked with "S" was overwritten provided that the PCS supports alarm messages.
BLOCK_ALM		This parameter is used to signal to the PCS diagnostic messages displayed in BLOCK_ERR provided that the PCS supports alarm messages.

8.2.7 Resource Block

Parameters

Parameter	Char.	Description
ST_REV		During each writing process to a parameter marked with "S", the parameter ST_REV is increased by 1.
TAG_DESC	W, S	Use this parameter to assign a tag to the valve interface (measuring point designation) in the plant or process.

Parameter	Char.	Description
STRATEGY	W, S	The strategy field can be used to identify comprising blocks. This data is not controlled or used by the block.
ALERT_KEY	W, S	Identification number of the plant component. This information can be used by the control computer, e.g., to sort alarms. Valid values are 1 ... 65536.
MODE_BLK	W, S	Displays the current, allowed normal mode and the target mode of the block. The target mode can be set to the values "Auto" or "Out of Service".
BLOCK_ERR		Displays diagnostic messages of the block.
RS_STATE		Current status of the device.
TEST_RW		Test parameter used to test the device.
DD_RESOURCE		FF standard parameter, not used.
MANUFAC_ID		Identification number of the device manufacturer. The parameter is used by the PCS to assign the device description (DD) to the device.
DEV_TYPE		Device type. The parameter is used by the control system to assign the device description to the device.
DEV_REV		Version number of the device. The parameter is used by the PCS to assign the device description to the device.
DD_REV		Version number of device description. The parameter is used by the PCS to assign the device description to the device.
GRANT_DENY	W	Regulates the access rights between PCS and local operator stations for some control systems.
HARD_TYPES		Hardware type.
RESTART	W	This parameter enables the user to carry out a new manual start. The following different types of restarts are possible: <ul style="list-style-type: none"> Restart resource Restart with defaults (default settings) Restart processor
FEATURES		Displays the options supported by the device. The options are: <ul style="list-style-type: none"> Reports: Alert reports Soft write lock: If enabled, the WRITE_LOCK parameter (if set) prevents any external change to the static or nonvolatile database in the function block application of the resource. Unicode strings: Unicode string Multi-bit alarm: If multi-bit alarms are enabled, block alarms are considered to be multi-bit alarms, and they are NOT treated as simple alarms. Fault state: If set, the FAULT_STATE parameter causes all output function blocks in the resource to go immediately to the condition chosen by the fault state type I/O option.
FEATURE_SEL	W, S	The options used are selected here. See FEATURES.
CYCLE_TYPE		The parameter provides the different block implementation methods for this device.

Parameter	Char.	Description
CYCLE_SEL	W, S	The parameter is used to display the block implementation method.
MIN_CYCLE_T		This parameter sets the shortest macro-cycle that can be used by this device.
MEMORY_SIZE		FF standard parameter. Not used.
NV_CYCLE_T		FF standard parameter. Not used.
FREE_SPACE		FF standard parameter. Not used.
FREE_TIME		FF standard parameter. Not used.
SHED_RCAS	W, S	The parameter defines the time until a communication failure is recognized in the "RCas" mode.
SHED_ROUT	W, S	The parameter defines the time until a communication failure is recognized in the "ROUT" mode.
FAULT_STATE		The parameter indicates whether the device global safety status was set. See SET_FSTATE and CLR_FSTATE.
SET_FSTATE	W, S	The parameter is used to set the device global safety status.
CLR_FSTATE	W, S	The parameter is used to reset the device global safety status.
MAX_NOTIFY		The parameter defines the maximum number of unacknowledged alarm messages that can be managed by the device.
LIM_NOTIFY	W, S	The parameter defines the maximum number of unacknowledged alarm messages that are admitted.
CONFIRM_TIME	W, S	The parameter sets the time during which an alarm is repeated unless acknowledged.
WRITE_LOCK		The parameter indicates the position of the read-only switch.
UPDATE_EVENT		This parameter is used to signal to the DSCS that a parameter identified with "S" was overwritten provided that the PCS supports alarm messages.
BLOCK_ALM		This parameter is used to signal to the PCS diagnostic messages displayed in BLOCK_ERR provided that the PCS supports alarm messages.
ALARM_SUM		The current status of the alarm messages of the block.
ACK_OPTION	W, S	The parameter determines whether the alarms of the resource block must be acknowledged.
WRITE_PRI		The parameter determines the priority of the alarm messages that are released when setting and resetting the read-only switch.
WRITE_ALM		The parameter determines if an alarm message is released when setting and resetting the read-only switch.
ITK_VER		The parameter assigns a version number to the interoperability test that was used to test the device.
SERIAL_NUM		The parameter assigns a serial number to the device.
SW_REV		The parameter sets a version status of software used by the device.
FD_VER		A parameter equal to the value of the major version of the field diagnostics specification according to which this device was designed.

Parameter	Char.	Description
FD_FAIL_ACTIVE		This parameter reflects the fault conditions that are detected as active as selected for this category. Since this parameter is a bit string, multiple conditions can be issued.
FD_OFF-SPEC_ACTIVE		See FD_FAIL_ACTIVE
FD_MAINT_ACTIVE		See FD_FAIL_ACTIVE
FD_CHECK_ACTIVE		See FD_FAIL_ACTIVE
FD_FAIL_MAP	S, W, OOS	This parameter maps conditions to be detected as active for this alarm category. Thus, the same condition can be active in all, some, or none of the 4 alarm categories.
FD_OFF-SPEC_MAP	S, W, OOS	See FD_FAIL_MAP
FD_MAINT_MAP	S, W, OOS	See FD_FAIL_MAP
FD_CHECK_MAP	S, W, OOS	See FD_FAIL_MAP
FD_FAIL_MASK	S, W, OOS	This parameter allows the user to suppress any single or multiple conditions that are active in this category from being transmitted to the host through the alarm parameter. 1 bit = 1 masks, i. e., inhibits the transmission of a condition 1 bit = 0 unmask, i. e., enables transmission of a condition
FD_OFF-SPEC_MASK	S, W, OOS	See FD_FAIL_MASK
FD_MAINT_MASK	S, W, OOS	See FD_FAIL_MASK
FD_CHECK_MASK	S, W, OOS	See FD_FAIL_MASK
FD_FAIL_ALM		This parameter is primarily used to transmit a change in the associated active conditions that are not masked, for this alarm category to a host system.
FD_OFF-SPEC_ALM		See FD_FAIL_ALM
FD_MAINT_ALM		See FD_FAIL_ALM
FD_CHECK_ALM		See FD_FAIL_ALM
FD_FAIL_PRI	S, W, OOS	This parameter allows the user to specify the priority of this alarm category.
FD_OFF-SPEC_PRI	S, W, OOS	See FD_FAIL_PRI
FD_MAINT_PRI	S, W, OOS	See FD_FAIL_PRI
FD_CHECK_PRI	S, W, OOS	See FD_FAIL_PRI

Parameter	Char.	Description
FD_SIMULATE	S, W, OOS	This parameter allows the conditions to be manually supplied when simulation is enabled. When simulation is disabled, both the simulated diagnostic value and the diagnostic value track the actual conditions. The simulation jumper is required for simulation to be enabled. While simulation is enabled, the recommended action shows that simulation is active.
FD_RECOMMEN_ACT		This parameter is a device-enumerated summarization of the most severe condition or conditions detected.
SERIAL NUMBER		Pepperl+Fuchs serial number of the gateway.
SW_REV		Software revision of the gateway.
IP_ADDRESS		IP address of the device (when an Ethernet connection is present).
DGW_MODE	W, S	DGW-FF mode. The device can operate in 2 modes: <ul style="list-style-type: none"> • 0x01: FDS – Connect via FDS is allowed, ADMs are controlled by FDS, the ADM_TB block is not operational • 0x02: FF – No connect via FDS is allowed, ADMs are controlled via ADM_TB blocks
ADM_X-D_STATUS		For internal usage
FB_INFO		For internal usage
TB_INFO		For internal usage
SEGMENT_MODE_INFO		For internal usage
SNAP-SHOT_MIN_1		For internal usage
SNAP-SHOT_MIN_2		For internal usage
SNAP-SHOT_MIN_3		For internal usage
SNAP-SHOT_MIN_4		For internal usage
SNAP-SHOT_MAX_1		For internal usage
SNAP-SHOT_MAX_2		For internal usage
SNAP-SHOT_MAX_3		For internal usage
SNAP-SHOT_MAX_4		For internal usage

8.3 HD2-GT-2AD.FF.IO FF Channel List

Channel Number	Data Type	Allowed for FB	Content
1	DS-66	DI	Value: Summary status all ADMs mapped as follows:
			XD_STATUS value Result

2020-11

Channel Number	Data Type	Allowed for FB	Content
			No Error 0
			Maintenance Required 1
			Out of Specification 1
			Excellent 0
			Good 0
			Fail 1
			Configuration Error 1
			No ADM Connected 1
			Segment Disabled 0
			All ADM_TB with a target mode of AUTO are taken into account. Status: <ul style="list-style-type: none"> Bad (Out of Service) if all ADM_TBs are in Out-of-Service mode Good (NC) in all other cases
2	8 x DS-66	MDI	Value: Status of ADMs with address 1 ... 8 mapped to "0" and "1" like channel 1. Status: <ul style="list-style-type: none"> Bad (Out of Service) if corresponding ADM_TBs is in Out-of-Service mode Good (NC) in all other cases
3	8 x DS-66	MDI	Same as channel 2, but for ADMs 9 ... 16
11	DS-66	DI	Value: Summary status all ADMs encoded as follows:
			XD_STATUS value Value
			No Error 0x00
			Maintenance Required 0x01
			Out of Specification (commissioned mode) 0x02
			Excellent 0x10
			Good 0x11
			Out of Specification (non-commissioned mode) 0x12
			Fail 0x20
			Configuration Error 0x21
			No ADM Connected 0x22
			Segment Disabled 0x23
			All ADM_TB with a target mode of AUTO are taken into account. Status: <ul style="list-style-type: none"> Bad (Out of Service) if all ADM_TBs are in Out-of-Service mode Good (NC) in all other cases

Channel Number	Data Type	Allowed for FB	Content
12	8 x DS-66	MDI	Value: Status of ADMs with Address 1 ... 8 encoded like channel 11 Status: <ul style="list-style-type: none"> • Bad (Out of Service) if corresponding ADM_TB is in Out-of-Service mode • Good (NC) in all other cases
13	8 x DS-66	MDI	Same as channel 12 but for ADMs 9 ... 16
101	8 x DS-66	MDI	Input value and status of binary inputs 1 ... 8
102	8 x DS-66	MDI	1 ... 4: Value and status of on/off controller 1 ... 4 5 ... 8: Value 0, status "Bad"
103	8 x DS-65	MAI	1: Value and status of temperature input 1 2: Value and status of temperature input 2 3: Value and status of board temperature 4: Value and status of board humidity 5: Value and status of frequency input 1 6: Value and status of frequency input 2 7, 8: Value 0, status "Bad"
104	8 x DS-65	MDO	1: Relay contact output 1 (output source of relay contact output 1 must be set to "FF channel") 2: Relay contact output 2 (output source of relay contact output 2 must be set to "FF channel") 3: Buzzer (output source of buzzer must be set to "FF channel") 4: Common alarm output (output source of common alarm output must be set to "FF channel") 5 ... 8: Ignored
105	1x DS-66	DI, MDI	Status of BINARY_INPUT_1 ... BINARY_INPUT_8 as bits of the U8. If channel is used for MDI, only OUT_1 is used!
201	1x DS-66	DI	Field diagnostic of resource block

8.4

HD2-GT-2AD.FF.IO FF Field Diagnostic Conditions

Bit	Name	Description	Default Mapping
0	Check Function	Actual block mode does not match normal mode and normal mode is unequal to OOS.	Check function
1	ADM Maintenance Required	Any ADM system or segment where the corresponding ADM_TB with target mode "AUTO" has a status of "Maintenance Required".	Maintenance Required
2	ADM Out of Specification	Any ADM system or segment where the corresponding ADM_TB with target mode "AUTO" has a status of "Out of Specification".	Offspec
3	ADM Non Commissioned	Any ADM where the corresponding ADM_TB with target mode "AUTO" has non-commissioned segments.	Check function
4	ADM Fail	Any ADM system or segment where the corresponding ADM_TB with target mode "AUTO" has a status of "Fail".	Fail
5	ADM Not Connected	Any ADM_TB with target mode "AUTO" where no corresponding ADM can be found on any diagnostic bus.	Fail

Bit	Name	Description	Default Mapping
6	IO Out of Specification	Any bit in IO_TB.FD_OOS_ACTIVE is set when IO_TB has a target mode of "AUTO".	Offspec
7	IO Maintenance Required	Any bit in IO_TB.FD_MR_ACTIVE is set when IO_TB has a target mode of "AUTO".	Maintenance Required
8	IO Fail	Any bit in IO_TB.BINARY_ERRORS or ANALOG_ERRORS is set when IO_TB has a target mode of "AUTO".	Fail
9	Block Configuration error	Any transducer block with target mode "AUTO" of the device shows a block configuration error.	Maintenance Required
10 ... 31	Not used		

8.5 Expert System Phenomena IDs

ID	Phenomenon	Cause(s)	Action(s)
101	Signal level is too high, only host communication and segment power are detected	Trunk breakage between fieldbus power supply and first device coupler	Check trunk, fieldbus power supply terminals and first device coupler
102	Signal level of one or more devices is too high	Not enough terminators	Check if a terminator is installed on both ends of the trunk
		Trunk breakage between device couplers	Check trunk cable and device coupler terminals
		Topology error - installed topology does not match configured topology	Check that the topology settings match the installation
103	Signal level of one or more devices is too low for the given topology	Too many terminators	Check that one terminator is installed on each end of the trunk cable, but no more than these two in total
		Terminal failure: corrosion	Check if the resistance of any terminal is too high
		Cable resistance is too high	Check if the correct cable is installed and the cable can be used for the topology
		Topology error - installed topology does not match configured topology	Check that the topology settings match the installation
104	Segment voltage is measured as zero. Segment is unpowered	Fieldbus power supply failed	Replace fieldbus power supply module
		Bulk power supply failed	Check bulk power supply
		Fieldbus power supply removed	Install fieldbus power supply
		Cable breakage, short circuit or terminal connection failure	Check cabling and terminals
		Diagnostic device is wrongly or not connected to the segment	Check wiring connection to the segment

ID	Phenomenon	Cause(s)	Action(s)
105	The segment is powered and communication is active, but no devices are detected	Wrong fieldbus type selected	Set fieldbus type to FOUNDATION Fieldbus or PROFIBUS PA
106	Segment powered and OK but no communication detected	Host/LAS/master communication fault	Check host/LAS/master
		No host connected	Check if the host is installed and correctly connected to the segment
107	Segment voltage is out of range for the given topology	Wrong fieldbus power supply installed or wrong topology configured	Replace fieldbus power supply or correct topology settings
108	Noise is "Out of specification" for the segment	Noise injection on the fieldbus	Check fieldbus cable for correct shielding and grounding. Check for external noise sources.
		Shield wiring / grounding fault	Check fieldbus cable for correct shielding and grounding.
109	Jitter is "Out of specification" for the segment	Fieldbus impedance fault	Check if the fieldbus topology is valid. Check noise, reduce high noise values.
		Wrong cable type, cable impedance not correct	Check if the correct cable is installed and the cable can be used for the topology
		Not enough terminators	Check if a terminator is installed on both ends of the trunk
110	Jitter of one device is "Out of specification", jitter is not "Out of specification" for the other devices	Device malfunction: jitter of a device is too high	Replace device
		Not enough terminators	Check if a terminator is installed on both ends of the trunk
		Fieldbus impedance fault	Check if the fieldbus topology is valid. Check noise, reduce high noise values.
111	Unbalance is "Out of specification" to fieldbus +	Short circuit/leakage current between fieldbus pos. pole and shield/ground	Remove connection between pos. pole and shield/ground
		Water ingress	Check housings of devices and junction boxes for water ingress
112	Unbalance is "Out of specification" to fieldbus -	Short circuit/leakage current between fieldbus neg. pole and shield/ground	Remove connection between neg. pole and shield/ground
		Water ingress	Check housings of devices and junction boxes for water ingress
113	Noise of one device is "Out of specification", noise is not "Out of specification" for the other devices	Device injects noise	Check noise with the fieldbus oscilloscope. The device showing high noise values is not necessarily the one injecting the noise.

ID	Phenomenon	Cause(s)	Action(s)
115	Signal level of one device is too low for the given topology, signal level of others OK	Device malfunction: Signal level is too low	Replace device
		Too many terminators	Check that one terminator is installed on each end of the trunk cable, but no more than these two in total
116	Signal level of one device is too high for the given topology	Measurement executed at spur	Connect to proper measurement point
117	Segment voltage is too low	Terminal failure: corrosion	Check if the resistance of any terminal is too high
		Topology error - non-working topology	Check if the topology is valid according to the fieldbus specification
		Cable resistance is too high	Check if the correct cable is installed and the cable can be used for the topology
		Topology error - installed topology does not match configured topology	Check that the topology settings match the installation
120	Signal level is too high, only host is active and segment is powered	Trunk breakage between fieldbus power supply and first device coupler	Check trunk, fieldbus power supply terminals and first device coupler
121	Signal level of one or more devices is too high	Not enough terminators	Check if a terminator is installed on both ends of the trunk
		Trunk breakage between device couplers	Check trunk cable and device coupler terminals
		Topology error - installed topology does not match configured topology	Check that the topology settings match the installation
122	Signal level of one or more devices is too low for the given topology	Too many terminators	Check that one terminator is installed on each end of the trunk cable, but no more than these two in total
		Terminal failure: corrosion	Check if the resistance of any terminal is too high
		Cable resistance is too high	Check if the correct cable is installed and the cable can be used for the topology
		Topology error - installed topology does not match configured topology	Check that the topology settings match the installation
123	Voltage of Bulk Power Supply (Primary or Secondary) is "Out of specification"	Bulk power supply voltage error	Check and correct voltage of bulk power supply

ID	Phenomenon	Cause(s)	Action(s)
124	No Bulk Power Supply (Primary or Secondary) connected	Bulk power supply failed (Bulk Power Supply (Primary or Secondary))	Check bulk power supply (Bulk Power Supply (Primary or Secondary))
		Wiring between bulk power supply and Board failed	Check if bulk power supply is correctly wired to the power supply
		Terminal failure: loose connection	Check all terminals for correct connection
125	Type of fieldbus power supply A differs from B	Power supply mismatch	Two different types of fieldbus power supplies are installed for the same segment. This is not allowed. Use only one type of fieldbus power supply for this segment.
126	Fieldbus power conditioner is only supported on universal motherboard	Non isolated Power Supply HD2-FBCL-1.500 not supported on this motherboard	Replace power supply module or motherboard
127	Fieldbus power supply failure detected	Trunk short circuit	Check trunk. If no spur short circuit protection is installed, also check spurs.
		Fieldbus power supply failed	Replace fieldbus power supply module
128	Segment Power Supply Module (A or B) failure detected, no redundancy available	Segment Power Supply Module (A or B) failed, redundant power supply module powers the segment	Replace Segment Power Supply Module (A or B)
129	Both fieldbus power supplies report failure, segment is unpowered	Trunk short circuit	Check trunk. If no spur short circuit protection is installed, also check spurs.
		Power supplies failed for the segment	Check and replace fieldbus power supplies
130	Both fieldbus power supplies report failure, segment is powered	Power supplies failed for the segment	Check and replace fieldbus power supplies
131	Unbalance is "Out of specification" to the positive pole	Short circuit/leakage current between fieldbus pos. pole and shield/ground	Remove connection between pos. pole and shield/ground
		Water ingress	Check housings of devices and junction boxes for water ingress
132	Unbalance is "Out of specification" to the negative pole	Short circuit/leakage current between fieldbus neg. pole and shield/ground	Remove connection between neg. pole and shield/ground
		Water ingress	Check housings of devices and junction boxes for water ingress
133	Segment Voltage is out of range for the given topology	Wrong fieldbus power supply installed or wrong topology configured	Replace fieldbus power supply or correct topology settings

ID	Phenomenon	Cause(s)	Action(s)
134	Noise of one device is "Out of specification", noise is not "Out of specification" for other devices	Device injects noise	Check noise with the fieldbus oscilloscope. The device showing high noise values is not necessarily the one injecting the noise.
135	Jitter of one device is "Out of specification", jitter is not "Out of specification" for other devices	Device malfunction: jitter of a device is too high	Replace device
		Not enough terminators	Check if a terminator is installed on both ends of the trunk
		Fieldbus impedance fault	Check if the fieldbus topology is valid. Check noise, reduce high noise values.
136	Signal level of one device is too low for the given topology, signal level of others is OK	Device malfunction: Signal level is too low	Replace device
		Too many terminators	Check that one terminator is installed on each end of the trunk cable, but no more than these two in total
137	Segment powered and OK but no communication detected	Host/LAS/master communication fault	Check host/LAS/master
		No host connected	Check if the host is installed and correctly connected to the segment
138	Segment Power Supply Module (A or B) not installed	Segment Power Supply Module (A or B) not installed	Install Segment Power Supply Module (A or B) on the motherboard
140	Noise is "Out of specification" for the segment	Shield wiring / grounding fault	Check fieldbus cable for correct shielding and grounding.
		Noise injection on the fieldbus	Check fieldbus cable for correct shielding and grounding. Check for external noise sources.
141	Jitter is "Out of specification" for the segment	Fieldbus impedance fault	Check if the fieldbus topology is valid. Check noise, reduce high noise values.
		Wrong cable type, cable impedance not correct	Check if the correct cable is installed and the cable can be used for the topology
		Not enough terminators	Check if a terminator is installed on both ends of the trunk
142	Current is too high for the fieldbus power supply	Fieldbus power supply overload	Check if there is any connection between fieldbus + and fieldbus - or remove devices
144	Signal level is too high, only host is active and segment is powered	Trunk breakage between fieldbus power supply and first device coupler	Check trunk, fieldbus power supply terminals and first device coupler
145	Signal level of one or more devices is too high and devices are missing compared to commissioning	Trunk breakage between device couplers	Check trunk cable and device coupler terminals
		Not enough terminators	Check if a terminator is installed on both ends of the trunk

ID	Phenomenon	Cause(s)	Action(s)
146	Signal level of one or more devices is too high	Not enough terminators	Check if a terminator is installed on both ends of the trunk
149	Segment voltage is measured as zero. Segment is unpowered	Fieldbus power supply failed	Replace fieldbus power supply module
		Bulk power supply failed	Check bulk power supply
		Fieldbus power supply removed	Install fieldbus power supply
		Cable breakage, short circuit or terminal connection failure	Check cabling and terminals
		Diagnostic device is wrongly or not connected to the segment	Check wiring connection to the segment
150	The segment is powered and communication is active, but no devices are detected	Wrong fieldbus type selected	Set fieldbus type to FOUNDATION Fieldbus or PROFIBUS PA
152	Noise "MR/OOS" for the segment	Noise injection on the fieldbus	Check fieldbus cable for correct shielding and grounding. Check for external noise sources.
		Shield wiring / grounding fault	Check fieldbus cable for correct shielding and grounding.
153	Jitter of one device "MR/OOS", jitter of other devices OK	Device malfunction: jitter of a device is too high	Replace device
		Not enough terminators	Check if a terminator is installed on both ends of the trunk
		Fieldbus impedance fault	Check if the fieldbus topology is valid. Check noise, reduce high noise values.
154	Unbalance is "OOS/MR" to fieldbus +	Short circuit/leakage current between fieldbus pos. pole and shield/ground	Remove connection between pos. pole and shield/ground
		Water ingress	Check housings of devices and junction boxes for water ingress
155	Unbalance is "OOS/MR" to fieldbus -	Short circuit/leakage current between fieldbus neg. pole and shield/ground	Remove connection between neg. pole and shield/ground
		Water ingress	Check housings of devices and junction boxes for water ingress
156	Noise of one device is "MR/OOS", value of other devices is not "MR/OOS"	Device injects noise	Check noise with the fieldbus oscilloscope. The device showing high noise values is not necessarily the one injecting the noise.

ID	Phenomenon	Cause(s)	Action(s)
157	Signal level of one device is too low, signal level of others OK	Device malfunction: Signal level is too low	Replace device
		Too many terminators	Check that one terminator is installed on each end of the trunk cable, but no more than these two in total
158	One device is missing compared to commissioning	Spur short circuit	Check spur of the missing device
		Spur breakage	Check spur cable and terminals of the missing device
		Device failed	Check and replace device
		Device unintentionally removed from the segment	Reinstall device or execute commissioning wizard again
		Device intentionally removed from segment	Execute commissioning wizard again
159	Signal level is too low	Too many terminators	Check that one terminator is installed on each end of the trunk cable, but no more than these two in total
		Terminal failure: corrosion	Check if the resistance of any terminal is too high
161	Segment powered and OK but no communication detected	Host/LAS/master communication fault	Check host/LAS/master
		No host connected	Check if the host is installed and correctly connected to the segment
162	Additional devices active compared to commissioning	Extra devices installed	Remove extra devices or execute commissioning wizard again
163	Devices are missing compared to commissioning	Device coupler failed	Check device couplers and device coupler terminals
		Device intentionally removed from segment	Execute commissioning wizard again
164	Segment voltage is lower compared to commissioning	Fieldbus power supply overload	Check if there is any connection between fieldbus + and fieldbus - or remove devices
		Fieldbus power supply failed	Check and replace fieldbus power supply
		Fieldbus power supply replaced with incompatible model	Install correct fieldbus power supply
165	Jitter is "MR/OOS" for the segment	Fieldbus impedance fault	Check if the fieldbus topology is valid. Check noise, reduce high noise values.
		Not enough terminators	Check if a terminator is installed on both ends of the trunk
166	Signal level of one device is too high, signal level of others is OK	Measurement executed at spur	Connect to proper measurement point

ID	Phenomenon	Cause(s)	Action(s)
167	Segment voltage is lower compared to commissioning	Terminal failure: corrosion	Check if the resistance of any terminal is too high
		Fieldbus power supply replaced with incompatible model	Install correct fieldbus power supply
		Fieldbus power supply failed	Check and replace fieldbus power supply
		Fieldbus power supply overload	Check if there is any connection between fieldbus + and fieldbus - or remove devices
169	Segment voltage is "Out of specification"	Fieldbus power supply failed	Check and replace fieldbus power supply
171	Segment voltage is measured as zero. Segment is unpowered	Fieldbus power supply failed	Replace fieldbus power supply module
		Bulk power supply failed	Check bulk power supply
		Fieldbus power supply removed	Install fieldbus power supply
		Cable breakage, short circuit or terminal connection failure	Check cabling and terminals
172	Segment voltage is measured as zero. Segment is unpowered	Fieldbus power supply failed	Replace fieldbus power supply module
		Bulk power supply failed	Check bulk power supply
		Fieldbus power supply removed	Install fieldbus power supply
		Cable breakage, short circuit or terminal connection failure	Check cabling and terminals
173	Segment voltage is "Out of specification"	Fieldbus power supply failed	Check and replace fieldbus power supply
174	Segment voltage is too low	Fieldbus power supply failed	Check and replace fieldbus power supply
		Terminal failure: corrosion	Check if the resistance of any terminal is too high
		Topology error - non-working topology	Check if the topology is valid according to the fieldbus specification
175	Segment voltage is too low: "Out of specification"	Terminal failure: corrosion	Check if the resistance of any terminal is too high
		Fieldbus power supply failed	Check and replace fieldbus power supply
		Fieldbus power supply replaced with incompatible model	Install correct fieldbus power supply
		Topology error - non-working topology	Check if the topology is valid according to the fieldbus specification
		Diagnostic device is wrongly or not connected to the segment	Check wiring connection to the segment

ID	Phenomenon	Cause(s)	Action(s)
177	The segment is powered and communication is active, but no devices are detected	Wrong fieldbus type selected	Set fieldbus type to FOUNDATION Fieldbus or PROFIBUS PA
178	Segment voltage is measured as zero. Segment is unpowered	Power supplies failed for the segment	Check and replace fieldbus power supplies
179	Segment voltage is "Out of specification"	Power supply module defect, Voltage is OOS	Replace power supply module
182	Both fieldbus power supplies report failure	Trunk short circuit	Check trunk. If no spur short circuit protection is installed, also check spurs.
		Power supplies failed for the segment	Check and replace fieldbus power supplies
183	No fieldbus power supply installed	No power supply module installed	Install power supply module for this segment
184	Segment voltage is measured as zero. Segment is unpowered	Trunk short circuit	Check trunk. If no spur short circuit protection is installed, also check spurs.
		Fieldbus power supply failed	Replace fieldbus power supply module
		Fieldbus power supply removed	Install fieldbus power supply
		Terminal failure: loose connection	Check all terminals for correct connection
		Diagnostic device is wrongly or not connected to the segment	Check wiring connection to the segment
185	Segment voltage is "Out of specification"	Power supply module defect, Voltage is OOS	Replace power supply module
188	Signal level is too high, only host is active and Segment is powered	Trunk breakage between fieldbus power supply and first device coupler	Check trunk, fieldbus power supply terminals and first device coupler
189	Signal level of one or more devices is too high and devices are missing compared to commissioning	Trunk breakage between device couplers	Check trunk cable and device coupler terminals
190	Signal level of one or more devices is too high	Not enough terminators	Check if a terminator is installed on both ends of the trunk
191	Signal level is too low: OOS/MR	Too many terminators	Check that one terminator is installed on each end of the trunk cable, but no more than these two in total
		Terminal failure: corrosion	Check if the resistance of any terminal is too high
192	Signal level of one device is MR/OOS (too low), signal level of others is OK	Device malfunction: Signal level is too low	Replace device
		Too many terminators	Check that one terminator is installed on each end of the trunk cable, but no more than these two in total

ID	Phenomenon	Cause(s)	Action(s)
193	No communication detected	Host/LAS/master communication fault	Check host/LAS/master
		No host connected	Check if the host is installed and correctly connected to the segment
194	The segment is powered and communication is active, but no devices are detected	Wrong fieldbus type selected	Set fieldbus type to FOUNDATION Fieldbus or PROFIBUS PA
195	Segment voltage is "Out of specification" (too low)	Power supplies failed for the segment	Check and replace fieldbus power supplies
196	Segment voltage is "Out of specification" (too high)	Power supply module defect, Voltage is OOS	Replace power supply module
197	Segment voltage changed compared to commissioning	Fieldbus power supply replaced with incompatible model	Install correct fieldbus power supply
198	Segment voltage is measured as zero. Segment is unpowered	Power supplies failed for the segment	Check and replace fieldbus power supplies
202	Both fieldbus power supplies report failure, segment is unpowered	Trunk short circuit	Check trunk. If no spur short circuit protection is installed, also check spurs.
		Power supplies failed for the segment	Check and replace fieldbus power supplies
203	No fieldbus power supply installed	No power supply module installed	Install power supply module for this segment
204	Segment Power Supply Module (A or B) is different compared to commissioning	Fieldbus power supply replaced with incompatible model	Install correct fieldbus power supply
205	Segment Power Supply Module (A or B) is missing	Segment Power Supply Module (A or B) not installed	Install Segment Power Supply Module (A or B) on the motherboard
206	Both fieldbus power supplies report failure, segment is powered	Power supplies failed for the segment	Check and replace fieldbus power supplies
207	Segment Power Supply Module (A or B) failure detected, no redundancy available	Trunk short circuit	Check trunk. If no spur short circuit protection is installed, also check spurs.
		Fieldbus power supply failed	Replace fieldbus power supply module
208	Segment Power Supply Module (A or B) failure detected	Segment Power Supply Module (A or B) failed, redundant power supply module powers the segment	Replace Segment Power Supply Module (A or B)
209	Both fieldbus power supplies report failure	Trunk short circuit	Check trunk. If no spur short circuit protection is installed, also check spurs.
		Power supplies failed for the segment	Check and replace fieldbus power supplies

ID	Phenomenon	Cause(s)	Action(s)
212	Segment voltage is measured as zero. Segment is unpowered	Trunk short circuit	Check trunk. If no spur short circuit protection is installed, also check spurs.
		Fieldbus power supply failed	Replace fieldbus power supply module
		Fieldbus power supply removed	Install fieldbus power supply
		Terminal failure: loose connection	Check all terminals for correct connection
		Diagnostic device is wrongly or not connected to the segment	Check wiring connection to the segment
213	Segment voltage is "Out of specification"	Power supplies failed for the segment	Check and replace fieldbus power supplies
215	Noise is MR/OOS for the segment	Noise injection on the fieldbus	Check fieldbus cable for correct shielding and grounding. Check for external noise sources.
		Shield wiring / grounding fault	Check fieldbus cable for correct shielding and grounding.
216	Noise of one device is MR/OOS, value is not MR/OOS of other devices	Device injects noise	Check noise with the fieldbus oscilloscope. The device showing high noise values is not necessarily the one injecting the noise.
217	Jitter is MR/OOS for the segment	Fieldbus impedance fault	Check if the fieldbus topology is valid. Check noise, reduce high noise values.
		Not enough terminators	Check if a terminator is installed on both ends of the trunk
218	Jitter of one device is OOS/MR, jitter of other devices is OK	Device malfunction: jitter of a device is too high	Replace device
		Not enough terminators	Check if a terminator is installed on both ends of the trunk
		Fieldbus impedance fault	Check if the fieldbus topology is valid. Check noise, reduce high noise values.
219	Unbalance is MR/OOS to the positive pole	Short circuit/leakage current between fieldbus pos. pole and shield/ground	Remove connection between pos. pole and shield/ground
		Water ingress	Check housings of devices and junction boxes for water ingress
220	Unbalance is OOS/MR to the negative pole	Short circuit/leakage current between fieldbus neg. pole and shield/ground	Remove connection between neg. pole and shield/ground
		Water ingress	Check housings of devices and junction boxes for water ingress

ID	Phenomenon	Cause(s)	Action(s)
227	Segment current is too high compared to commissioning and exceeds the specification of the power supply	Fieldbus power supply overload	Check if there is any connection between fieldbus + and fieldbus - or remove devices
228	Segment current increased compared to commissioning	Current consumption of the segment increased compared to commissioning	This indicates an upcoming failure of an active component. Check devices and device couplers.
230	Segment current is too low compared to commissioning	Current consumption of the segment decreased compared to commissioning	This indicates an upcoming failure of an active component. Check devices and device couplers.
231	One device is missing compared to commissioning	Spur short circuit	Check spur of the missing device
		Spur breakage	Check spur cable and terminals of the missing device
		Device failed	Check and replace device
		Device unintentionally removed from the segment	Reinstall device or execute commissioning wizard again
		Device intentionally removed from segment	Execute commissioning wizard again
232	Additional devices active compared to commissioning	Extra devices installed	Remove extra devices or execute commissioning wizard again
234	Devices are missing compared to commissioning	Device coupler failed	Check device couplers and device coupler terminals
		Device intentionally removed from segment	Execute commissioning wizard again
235	Status of the Bulk Power Supply (Primary or Secondary) Voltage is MR/OOS	Bulk power supply voltage error	Check and correct voltage of bulk power supply
236	Voltage of the Bulk Power Supply (Primary or Secondary) is 0 V	Wiring between bulk power supply and Board failed	Check if bulk power supply is correctly wired to the power supply
		Bulk power supply failed (Bulk Power Supply (Primary or Secondary))	Check bulk power supply (Bulk Power Supply (Primary or Secondary))
		Terminal failure: loose connection	Check all terminals for correct connection
238	Status is "Excellent"	No issues are detected for this segment	No action required
239	Status is "Good", no diagnostic messages	No issues are detected for this segment	No action required
240	No error	No issues are detected for this segment	No action required
241	No license available, Expert System not supported	The Expert System requires a license	Contact Pepperl+Fuchs to acquire the license required

ID	Phenomenon	Cause(s)	Action(s)
242	Minimum signal level of the segment is MR/OOS	Too many terminators	Check that one terminator is installed on each end of the trunk cable, but no more than these two in total
		Device malfunction: Signal level is too low	Replace device
		Terminal failure: corrosion	Check if the resistance of any terminal is too high
243	Maximum signal level of the segment is MR/OOS	Not enough terminators	Check if a terminator is installed on both ends of the trunk
		Trunk breakage between device couplers	Check trunk cable and device coupler terminals
244	Current motherboard type different from expected one	Motherboard Type changed compared to commissioning	Check if the installed motherboard is the desired one and execute the commissioning wizard or replace the motherboard
245	Fieldbus power supply A different from fieldbus power supply B or one slot empty	Power supply mismatch	Two different types of fieldbus power supplies are installed for the same segment. This is not allowed. Use only one type of fieldbus power supply for this segment.
246	One or more devices were detected but not constantly active during recording	Defective device, device removed or added, communication failure	Check report for affected devices
247	One or more devices were detected but were not constantly active during recording	Defective device, device removed or added, communication failure	Check report for affected devices
248	One or more devices were detected but were not constantly active during recording	Defective device, device removed or added, communication failure	Check report for affected devices
249	One or more devices were detected but not constantly active during recording	Defective device, device removed or added, communication failure	Check report for affected devices
250	No ADM connected	No ADM with the address used for this Transducer Block is connected to the diagnostic bus	Check if all required ADMs are connected and the addresses are set correctly
251	ADM Firmware too old	The firmware of the ADM is outdated for use with the diagnostic gateway	Update firmware to version 1.4 or newer
252	ADM Firmware is being updated	Firmware update for ADM is executed	Wait for the firmware update to be completed
253	Configuration error: Voltage limits	Segment voltage limits are set to invalid values (e.g. low limit higher than high limit)	Correct segment voltage limits

ID	Phenomenon	Cause(s)	Action(s)
254	Configuration error: Current limits	Segment current limits are set to invalid values (e.g. low limit higher than high limit)	Correct segment current limits
255	Configuration error: Signal level limits	Segment signal level limits are set to invalid values (e.g. low limit higher than high limit)	Correct segment signal level limits
256	Configuration error: Unbalance limits	Segment unbalance limits are set to invalid values (e.g. low limit higher than high limit)	Correct segment unbalance limits
257	Configuration error: Jitter limits	Segment Jitter limits are set to invalid values (e.g. value out of range)	Correct segment Jitter limits
258	Configuration error: Noise limits	Segment noise limits are set to invalid values (e.g. value out of range)	Correct segment noise limits
259	Configuration error: Duplicate configured node addresses	Two devices with the same address are configured for this segment	Remove the duplicated entry from the configured devices
260	Configuration error: Node signal level limits	The signal level limits of at least one device is set to invalid values (e.g. low limit higher than high limit)	Check and correct signal level limits for the configured devices
261	Segment is disabled	The diagnostic function for this segment is disabled	Check if this segment is unused or whether the diagnostic is supposed to be enabled
263	Diagnostic gateway is in FDS mode. ADMs are not handled	The diagnostic gateway can be used in FF or in FDS mode. You are currently accessing the diagnostic gateway using FF but it is configured for operation with an FDS.	Check the intended integration and set the diagnostic gateway mode parameter inside the resource block as required
264	Address collision on diagnostic bus channels	ADMs with the same address are used on both diagnostic buses of the ADM	Change the address to only have unique addresses
265	Too many devices active on the fieldbus	More devices on bus than diagnostic gateway can handle	Reduce the number of devices including the host to 18 or below
266	A device coupler Out of specification alarm is detected for one device	An ELS or a surge protector sends an alarm. Device coupler LED should blink three times	Check device sending the alarm and check any ELS and surge protectors connected to it
		A diagnostic value exceeds defined value. The device coupler LED should blink two times	Check the device coupler manual for details

ID	Phenomenon	Cause(s)	Action(s)
267	A device coupler "Out of specification" alarm is detected. Check Coupler LEDs for the alarm cause.	Spur short circuit	Check spur of the missing device
		An ELS or a surge protector sends an alarm. Device coupler LED should blink three times	Check device sending the alarm and check any ELS and surge protectors connected to it
		ELS sends alarm. The device coupler LED should blink three times	Check ELS of the device coupler with active alarms
		The spurs of missing devices or an empty spur shows bad current changes	Check cable connections and devices at the affected spur
		The maximum power rating of the device coupler is exceeded	Reduce power consumption of devices connected to the device coupler
		An empty spur is short circuited or shows bad current changes	Check empty spurs of the corresponding device coupler
		A diagnostic value exceeds defined value. The device coupler LED should blink two times	Check the device coupler manual for details
268	A device coupler "Maintenance required" alarm is detected	A diagnostic value exceeds defined value. The device coupler LED should blink one time	Check device coupler manual for details
269	A device coupler "Out of specification" alarm is detected for one device	An ELS or a surge protector sends an alarm. Device coupler LED should blink three times	Check device sending the alarm and check any ELS and surge protectors connected to it
		A diagnostic value exceeds defined value. The device coupler LED should blink two times	Check the device coupler manual for details
270	A device coupler "Out of specification" alarm is detected and devices are missing compared to commissioning	Spur short circuit	Check spur of the missing device
		The spurs of missing devices or an empty spur shows bad current changes	Check cable connections and devices at the affected spur
		The maximum power rating of the device coupler is exceeded	Reduce power consumption of devices connected to the device coupler

ID	Phenomenon	Cause(s)	Action(s)
271	A device coupler "Out of specification" alarm is detected for several devices	ELS sends alarm. The device coupler LED should blink three times	Check ELS of the device coupler with active alarms
		An ELS or a surge protector sends an alarm. Device coupler LED should blink three times	Check device sending the alarm and check any ELS and surge protectors connected to it
		A diagnostic value exceeds defined value. The device coupler LED should blink two times	Check the device coupler manual for details
		An empty spur is short circuited or shows bad current changes	Check empty spurs of the corresponding device coupler
272	A device coupler "Maintenance required" alarm is detected	A diagnostic value exceeds defined value. The device coupler LED should blink one time	Check device coupler manual for details
273	A Surge protector connected to the trunk is sending an alarm	A surge protector connected to the trunk detected its end of life	Check LEDs of the trunk surge protectors and replace the surge protectors reporting end of life
274	A Surge protector connected to the trunk is sending an alarm	A surge protector connected to the trunk detected its end of life	Check LEDs of the trunk surge protectors and replace the surge protectors reporting end of life
276	"Maintenance required" alarm of a device coupler detected	A diagnostic value exceeds defined value. The device coupler LED should blink one time	Check device coupler manual for details
277	"Out of specification" alarm of a device coupler detected for one device	An ELS or a surge protector sends an alarm. Device coupler LED should blink three times	Check device sending the alarm and check any ELS and surge protectors connected to it
		A diagnostic value exceeds defined value. The device coupler LED should blink two times	Check the device coupler manual for details

ID	Phenomenon	Cause(s)	Action(s)
278	"Out of specification" alarm of a device coupler detected. Check coupler LEDs for the alarm cause	Spur short circuit	Check spur of the missing device
		An ELS or a surge protector sends an alarm. Device coupler LED should blink three times	Check device sending the alarm and check any ELS and surge protectors connected to it
		ELS sends alarm. The device coupler LED should blink three times	Check ELS of the device coupler with active alarms
		The spurs of missing devices or an empty spur shows bad current changes	Check cable connections and devices at the affected spur
		An empty spur is short circuited or shows bad current changes	Check empty spurs of the corresponding device coupler
		The maximum power rating of the device coupler is exceeded	Reduce power consumption of devices connected to the device coupler
		A diagnostic value exceeds defined value. The device coupler LED should blink two times	Check the device coupler manual for details
279	"Maintenance required" alarm of a device coupler detected	A diagnostic value exceeds defined value. The device coupler LED should blink one time	Check device coupler manual for details
280	"Out of specification" alarm of a device coupler detected for one device	An ELS or a surge protector sends an alarm. Device coupler LED should blink three times	Check device sending the alarm and check any ELS and surge protectors connected to it
		A diagnostic value exceeds defined value. The device coupler LED should blink two times	Check the device coupler manual for details
281	"Out of specification" alarm of a device coupler detected and devices are missing compared to commissioning	Spur short circuit	Check spur of the missing device
		The spurs of missing devices or an empty spur shows bad current changes	Check cable connections and devices at the affected spur
		The maximum power rating of the device coupler is exceeded	Reduce power consumption of devices connected to the device coupler

ID	Phenomenon	Cause(s)	Action(s)
282	"Out of specification" alarm of a device coupler detected for several devices	An ELS or a surge protector sends an alarm. Device coupler LED should blink three times	Check device sending the alarm and check any ELS and surge protectors connected to it
		ELS sends alarm. The device coupler LED should blink three times	Check ELS of the device coupler with active alarms
		An empty spur is short circuited or shows bad current changes	Check empty spurs of the corresponding device coupler
		A diagnostic value exceeds defined value. The device coupler LED should blink two times	Check the device coupler manual for details
283	An unclassified error detected for the segment	Unidentifiable error is detected	Check detailed measurements
284	An unclassified error detected for the segment	Unidentifiable error is detected	Check detailed measurements
285	Devices with default addresses are active	One or more devices with default address(es) are active	Assign a permanent address to the device
286	One or more device tags or Device IDs are different to the given topology	One or more device tags or Device IDs documented in PC software differ from currently active devices	Check and correct device tags
287	One or more device tags or Device IDs are different compared to commissioning	One or more device tags or Device IDs recorded during commissioning differ from currently active devices	Correct device tags or execute commissioning again
288	Number of active devices different to Segment Checker design	Device count of the Segment Checker file differs from currently active devices	Check active devices and segment design
289	More than 32 devices are active	More than 32 devices are connected to the segment	Remove devices from the segment
290	More than 32 devices are active	More than 32 devices are connected to the segment	Remove devices from the segment
291	Signal level of one or more devices is too high	Trunk breakage between device couplers	Check trunk cable and device coupler terminals
		Not enough terminators	Check if a terminator is installed on both ends of the trunk

ID	Phenomenon	Cause(s)	Action(s)
292	"Out of specification" alarm of a device coupler detected for several devices	Spur short circuit	Check spur of the missing device
		The spurs of missing devices or an empty spur shows bad current changes	Check cable connections and devices at the affected spur
		The maximum power rating of the device coupler is exceeded	Reduce power consumption of devices connected to the device coupler
		An ELS or a surge protector sends an alarm. Device coupler LED should blink three times	Check device sending the alarm and check any ELS and surge protectors connected to it
		ELS sends alarm. The device coupler LED should blink three times	Check ELS of the device coupler with active alarms
		An empty spur is short circuited or shows bad current changes	Check empty spurs of the corresponding device coupler
		A diagnostic value exceeds defined value. The device coupler LED should blink two times	Check the device coupler manual for details
293	Signal level of one device is too low for the given topology, signal level of others OK	Device malfunction: Signal level is too low	Replace device
		Too many terminators	Check that one terminator is installed on each end of the trunk cable, but no more than these two in total
294	Signal level of one or more devices is too low for the given topology	Too many terminators	Check that one terminator is installed on each end of the trunk cable, but no more than these two in total
		Terminal failure: corrosion	Check if the resistance of any terminal is too high
		Cable resistance is too high	Check if the correct cable is installed and the cable can be used for the topology
		Topology error - installed topology does not match configured topology	Check that the topology settings match the installation
		Device coupler failed	Check device couplers and device coupler terminals
295	Signal level of one or more devices is too high	2 devices connected to a spur	Connect only one device to a spur
		Not enough terminators	Check if a terminator is installed on both ends of the trunk
		Topology error - installed topology does not match configured topology	Check that the topology settings match the installation

ID	Phenomenon	Cause(s)	Action(s)
296	Segment / spur voltage is 0 V	Fieldbus power supply failed	Replace fieldbus power supply module
		Fieldbus power supply removed	Install fieldbus power supply
		Bulk power supply failed	Check bulk power supply
		Device coupler failed	Check device couplers and device coupler terminals
		Cable breakage, short circuit or terminal connection failure	Check cabling and terminals
		Diagnostic device is wrongly or not connected to the segment	Check wiring connection to the segment
297	Segment / spur voltage is too low	Fieldbus power supply failed	Check and replace fieldbus power supply
		Terminal failure: corrosion	Check if the resistance of any terminal is too high
		Fieldbus power supply replaced with incompatible model	Install correct fieldbus power supply
		Topology error - non-working topology	Check if the topology is valid according to the fieldbus specification
298	Segment / spur voltage is too low	Fieldbus power supply overload	Check if there is any connection between fieldbus + and fieldbus - or remove devices
		Fieldbus power supply failed	Check and replace fieldbus power supply
		Fieldbus power supply replaced with incompatible model	Install correct fieldbus power supply
		Terminal failure: corrosion	Check if the resistance of any terminal is too high
		Device coupler failed	Check device couplers and device coupler terminals
299	Signal level of one device is too low, signal level of others OK	Device malfunction: Signal level is too low	Replace device
		Too many terminators	Check that one terminator is installed on each end of the trunk cable, but no more than these two in total
300	Signal level is too low	Too many terminators	Check that one terminator is installed on each end of the trunk cable, but no more than these two in total
		Terminal failure: corrosion	Check if the resistance of any terminal is too high
301	Signal level of devices is too high and devices are missing compared to commissioning	Trunk breakage between device couplers	Check trunk cable and device coupler terminals

ID	Phenomenon	Cause(s)	Action(s)
302	Signal level of one or more devices is too high	Not enough terminators	Check if a terminator is installed on both ends of the trunk
		2 devices connected to a spur	Connect only one device to a spur
303	Segment / spur voltage is 0 V	Fieldbus power supply failed	Replace fieldbus power supply module
		Fieldbus power supply removed	Install fieldbus power supply
		Bulk power supply failed	Check bulk power supply
		Device coupler failed	Check device couplers and device coupler terminals
		Cable breakage, short circuit or terminal connection failure	Check cabling and terminals
		Diagnostic device is wrongly or not connected to the segment	Check wiring connection to the segment
304	Segment / spur voltage is too low	Fieldbus power supply failed	Check and replace fieldbus power supply
		Terminal failure: corrosion	Check if the resistance of any terminal is too high
		Topology error - non-working topology	Check if the topology is valid according to the fieldbus specification
		Device coupler failed	Check device couplers and device coupler terminals
305	Devices are missing compared to commissioning	Devices detected during commissioning are not active	Solve other reported errors first and check segment again
306	Devices are missing compared to commissioning	Devices detected during commissioning are not active	Solve other reported errors first and check segment again
307	Segment voltage is too high for the given topology	Wrong fieldbus power supply installed or wrong topology configured	Replace fieldbus power supply or correct topology settings
308	Segment voltage is too high	Fieldbus power supply failed	Check and replace fieldbus power supply
309	Segment voltage is higher compared to commissioning	Fieldbus power supply failed	Check and replace fieldbus power supply
		Fieldbus power supply replaced with incompatible model	Install correct fieldbus power supply
310	Segment voltage is "Out of specification"	Fieldbus power supply failed	Check and replace fieldbus power supply
311	Segment voltage is too high compared to commissioning	Fieldbus power supply replaced with incompatible model	Install correct fieldbus power supply
		Fieldbus power supply failed	Check and replace fieldbus power supply
		This is possibly a result of other errors	Solve other reported errors first and check segment again

ID	Phenomenon	Cause(s)	Action(s)
312	Segment / spur voltage is too high	Fieldbus power supply failed	Check and replace fieldbus power supply
		Device coupler failed	Check device couplers and device coupler terminals
313	Segment / spur voltage is too high compared to commissioning	Fieldbus power supply replaced with incompatible model	Install correct fieldbus power supply
		Fieldbus power supply failed	Check and replace fieldbus power supply
		This is possibly a result of other errors	Solve other reported errors first and check segment again
		Device coupler failed	Check device couplers and device coupler terminals
314	Segment / spur voltage is too high	Device coupler failed	Check device couplers and device coupler terminals
		Fieldbus power supply failed	Check and replace fieldbus power supply
315	FDH-1 appears to be connected to a spur	The signal level of one device is too high	If FDH-1 is not connected to a spur, re-check with a specific segment record
316	Jitter is "Out of specification" and the signal level of devices is too high for the given topology	Not enough terminators	Check if a terminator is installed on both ends of the trunk
317	Jitter is Good and the signal level of devices is too high for the given topology	Not enough terminators	Check if a terminator is installed on both ends of the trunk
318	Jitter is "Good" and the signal level of devices is too high for the given topology	Not enough terminators	Check if a terminator is installed on both ends of the trunk
319	Jitter is "Out of specification" and devices signal level is too high for the given topology	Not enough terminators	Check if a terminator is installed on both ends of the trunk
320	Segment voltage too high for the given topology	Wrong fieldbus power supply installed or wrong topology configured	Replace fieldbus power supply or correct topology settings

8.6 DGW-FF Troubleshooting

LEDs

Behavior	Cause	Action
Green PWR is OFF	No power supply	Check power supply and wiring
Red ERR is ON	Hardware failure detected	Send device to manufacturer
Red ERR flashes	ADM address conflict	Check for ADMs that have the same addresses, one connected to CH1 other to CH2
Yellow Link/Act flashes	Ethernet communication is active	No error
Yellow CH1 is OFF (FF Mode)	No ADMs detected on channel	Check wiring. Are there ADMs supposed to be connected to the channel?

Behavior	Cause	Action
Yellow CH1 flashes (FF Mode)	ADM outside address range 1 ... 16 detected	Check address setting of ADMs, only address 1 ... 16 are supported in FF mode
Yellow CH1 is ON (FF Mode)	One or more ADMs detected	No error
Yellow CH1 flashes (FDS Mode)	One or more ADMs detected	No error
Yellow CH1 is ON (FDS Mode)	DTM communication active or one or more configured devices are active	No error
Red ALM flashes	Common alarm output is active (open)	Depends on configuration of common alarm output in IO_TB

ADM_TB

Phenomenon	Cause	Action
Block error: Configuration error	One or more parameters of the block do not meet their constraints	Check the expert system messages of all 4 segments. They contain information on the error cause.
Block error: Other	Status of any ADM segment is not Excellent, Good or No Error. See XD_STATUS parameter.	Check the affected segment diagnostics (expert system).

IO_TB

Phenomenon	Cause	Action
Block error: Configuration error	One or more parameters of the block do not meet their constraints	<ul style="list-style-type: none"> Check on/off controller turn on/off limits (turn-on value must be greater than turn-off value) Check Maintenance Required and Out of Specification limits of all analog inputs (temperature, humidity, frequency). On/off controller has input temperature difference and different units are selected for temperature 1 & 2
Block error: Other	XD_ERROR is Maintenance Required or Out of Specification	Check FD_OOS_ACTIVE or FD_MR_ACTIVE for the input causing the problem.

Function Blocks

Phenomenon	Cause	Action
Any block error	Various	See BLOCK_ERROR_DESC_1 parameter for information on the error.

8.7 Discovery and Configuration Tool (PFDCT)

The discovery and configuration tool (PFDCT) is used to configure the basic TCP/IP network settings of the diagnostic gateway and to update the firmware of the device.

This software can access the diagnostic gateway, provided that the computer running the software is located in the same subnet as the diagnostic gateway. Even if the TCP/IP settings are not compatible to the currently used network, the software can continue to reach the gateway.

The software can be downloaded from the Pepperl+Fuchs website. For further detailed information on the functionality of the software, refer to the PFDCT brief instructions.

8.8 Alarm Hysteresis and Reset

The hysteresis range prevents an activated alarm from being turned on and off repeatedly, if a measured value oscillates around the limit value. When the measured value exceeds the alarm value level, the corresponding maintenance or Out-of-Specification alarm is activated. This alarm stops only if the measured value falls below the alarm value including the hysteresis range or if someone resets the alarm manually.

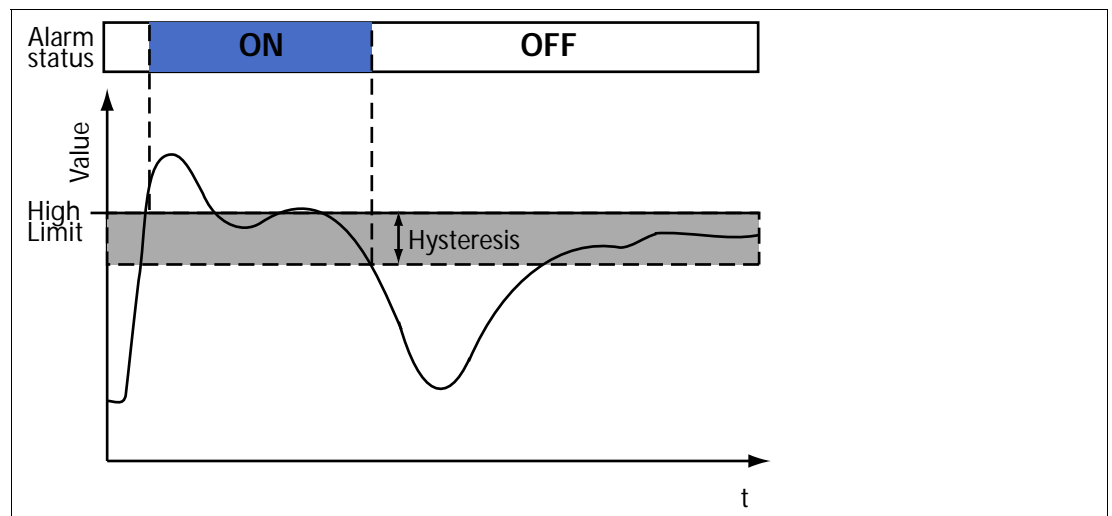

Figure 8.4 Hysteresis and alarm status

Type	Value
Voltage	0.8 V
Current	20 mA
Unbalance	10%
Signal level	50 mV
Noise	25 mV
Jitter	0.5 us

The Maintenance-Required and Out-of-Specification limits for the I/O functionality of the KT-MB-GT2AD.FF.IO also generate a configurable hysteresis.

If the FDS/OPC integration is used, alarms can be reset if the alarm is outside the alarm range, but the alarm is still active because of the hysteresis. Open the advanced parameterization and use the **Reset** buttons located in the configuration section of the alarm to clear the alarm in this case.

8.9 Field Device Handling for PROFIBUS

PROFIBUS devices can have 2 different status:

- In data exchange
- Not in data exchange

If at least one PROFIBUS device is in data exchange, the measurement takes place only for PROFIBUS masters and devices that are in data exchange. All other devices are disabled for the measurement.

To analyze PROFIBUS devices that are not in data exchange, you can use the oscilloscope function. See chapter 5.12

If multiple segments are linked together via a repeater like in a PROFIBUS PA Segment Coupler SK2, application monitoring takes place for all field devices connected to the same logical segment. To prevent the analysis of field devices not connected to the same physical segment as the ADM, you can add all devices of the segment to the configured field devices list and activate "Address Filter Active". If the filter is activated, only field devices in the configured list are monitored. All other field devices are ignored.

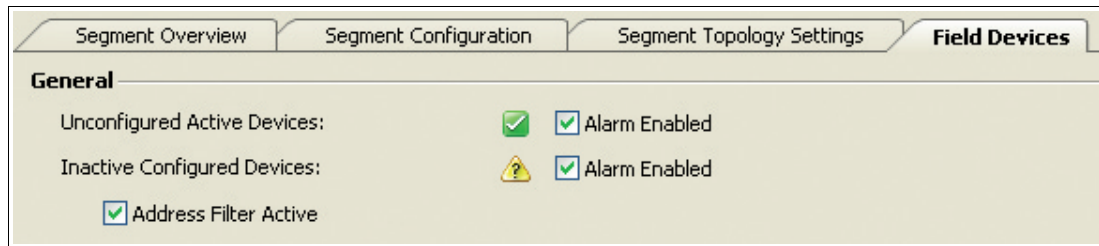

Figure 8.5 PROFIBUS address filter active checkbox

8.10 Online and Offline Data Sets

Each DTM provides 2 different types of user interfaces:

- Online data set
- Offline data set

An online interface shows the current values stored in the device. An offline interface shows the values currently stored in the dataset of the DTM inside the FDT project.

If an ADM is replaced with a new ADM, this online data will be lost. In order to prevent such data loss, the data from the online data set can be uploaded to the offline data set and downloaded to the device again later.

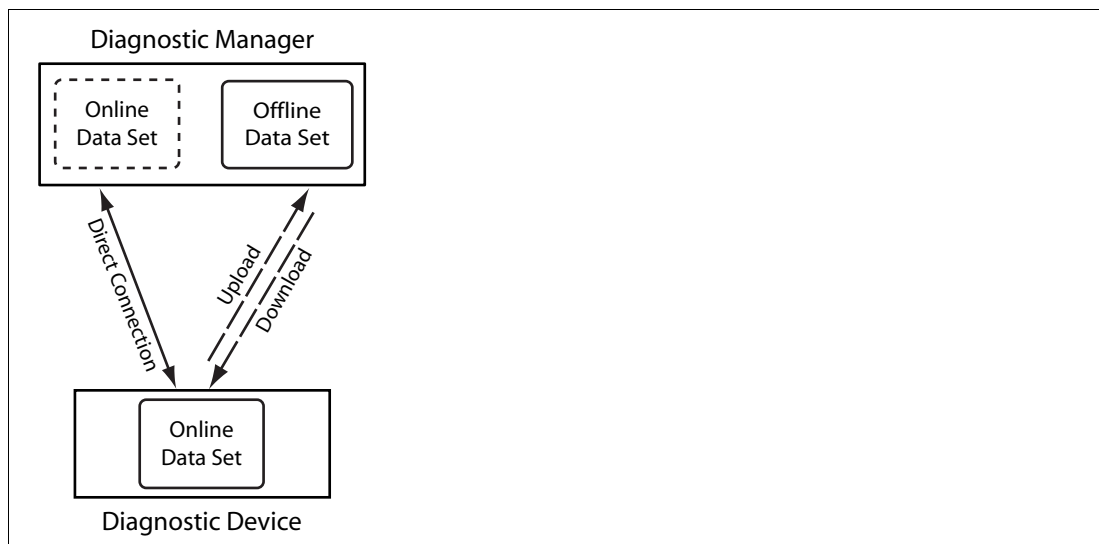

Figure 8.6 Online and Offline Data Set

8.11 HD2-GT-2AD.FF.IO Web Server

The diagnostic gateway features a built-in web server. You can access this web server by entering the IP address or DNS name of the diagnostic gateway into a web browser. The web server provides the following features:

2020-11

Status

Overview of all connected ADMs and their diagnostic states.

The screenshot displays the FieldConnex web interface. At the top left is the FieldConnex logo. To its right, device information is listed: IP Address: 172.24.114.196, Serial Number: 000d8100171DDZ, and Tag: VR-12-A. Further right, it shows FDS Lock from: 172.24.114.181, Gateway Status: [checked], and Status of ADMs: [warning icon].

On the left side, there is a navigation menu with the following items: Status, Configuration, Subnet Scan, and Cabinet Management. The 'Status' item is currently selected.

The main content area is titled 'ADM List (1 device)' and contains a table with the following data:

Address	Channel	Configured	Diagnostic Status	Info
1	1	yes	[checked] / [warning icon] [warning icon] [warning icon]	

At the bottom of the interface, there are links for 'Contact' and 'Icon Legend', and the Pepperl+Fuchs logo is visible in the bottom right corner.

Configuration

- Modify network settings of the DGW.

Warning: If you change the IP settings to an invalid value, you cannot access the web server again. In this case, use the diagnostic gateway configuration tool to correct the values.

- Change the diagnostic gateway mode to FDS or FF.
- Unlock the diagnostic gateway if it is locked from an FDS.
- Locate the device. The device flashes all LEDs of the diagnostic gateway.
- Check the firmware revision and the MAC ID.
- Update the firmware of the diagnostic gateway.

Subnet Scan

The subnet scan window shows a list of all diagnostic gateways in the same TCP/IP subnet and the status of their connected ADMs. The IP address of the listed diagnostic gateway is a link. Click the link to open the corresponding website.

Cabinet Management

The cabinet management window shows the current measured data for the cabinet management I/Os and the associated configuration.

The screenshot displays the FieldConnex diagnostic interface. At the top left is the FieldConnex logo. To its right, system information is listed: IP Address: 172.24.114.196, Serial Number: 000d8100171DDZ, and Tag: VR-12-A. Further right, status indicators are shown: FDS Lock from: not locked, Gateway Status: [green checkmark], and Status of ADMs: [yellow warning triangle].

A left-hand navigation menu contains the following items: Status, Configuration, Subnet Scan, Cabinet Management (selected), and Configuration (under Cabinet Management).

The main content area is titled "Cabinet Management" and is divided into three sections:

- Ambient Conditions:**

Temperature Input 1 ()	[red X]	Sensor failure (low limit underrun)
Board Temperature	[green checkmark]	29.9 °C
Board Humidity	[green checkmark]	32.0 %
- Binary Inputs:**

Binary Input 1 ()	[green checkmark]	Open
Binary Input 2 ()	[green checkmark]	Open
Binary Input 3 ()	[green checkmark]	Open
Binary Input 4 ()	[green checkmark]	Open
Binary Input 5 ()	[yellow warning triangle]	Sensor failure
Binary Input 6 ()	[green checkmark]	Open
Binary Input 8 ()	[green checkmark]	Open
- Binary Outputs:**

Relay Output 1 ()	[green checkmark]	Open
Relay Output 2 ()	[green checkmark]	Open
Common Alarm Output	[green checkmark]	Open

At the bottom left, there is a "Contact" link and an "Icon Legend" link. At the bottom right, the PEPPERL+FUCHS logo is displayed.

8.12 OPC Server Details

8.12.1 OPC-DA Server Name Space

OPC servers provide a method that enables different software packages to access data from process control devices. OPC-DA and OPC-AE server are installed together with the diagnostic manager by default. This OPC server communicates with the FDS and provides data for access from several OPC clients.

The name space of the OPC-DA server is structured as follows:

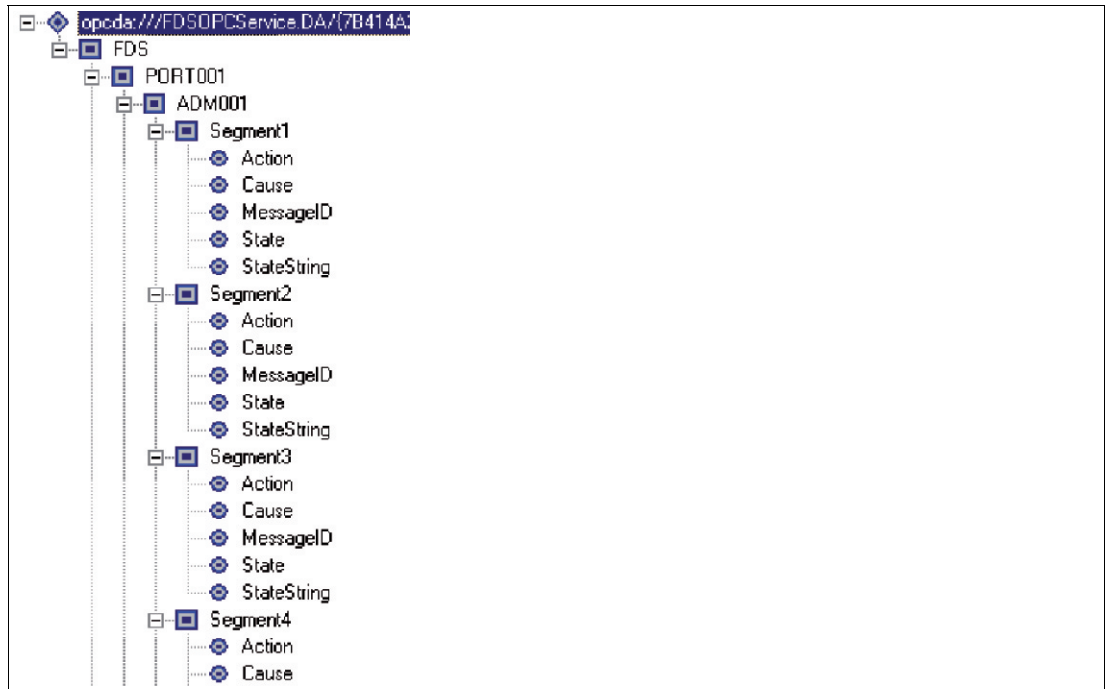

Figure 8.7 OPC-DA name space structure



Note

Failures that occurred on system level are also shown on the segment level.

OPC-DA Server Names and Meanings

Name	Meaning
FDSOPCService.DA	Name of the OPC service (PROG_ID)
FDS	Tag of the FDS server
Port	TAG of the FDS port
DMA 001 (1-4)	Tag of the diagnostic module and the appropriate segment
Action	Instructions for troubleshooting
Cause	Cause of fault
MessageID	Unique ID of failure message (see chapter 8.12.2)
State	Describes the current status of the node by the following values: 0: No Error 1: Maintenance Required 2: Out of Specification 3: Hardware Error 4: Communication Error
StateString	String of the corresponding state
SummarizedState	Provides the highest prior state-data-value and the prior state-data-quality for the actual and all subordinate nodes (priorities see below)

Value Definitions and Priorities

State Value	Meaning
0	No Error
1	Maintenance Required
2	Out of Specification
3	Hardware Error
4	Communication Error

State Data Quality	Meaning
BAD, Comm_FAILURE	A communication error between the OPC server and the FDS server has occurred.
BAD, NON_SPECIFIC	FDS server has not polled the diagnostic module yet (temporary state).
BAD, OUT_OF_SERVICE	A segment is disabled.
UNCERTAIN, NON_SPECIFIC	Occurs if the diagnostic module is connected via the FDS to a Pepperl+Fuchs fieldbus gateway that also processes alarms. This is an invalid operating state.
GOOD	None of the above applies.

SummarizedState Priority	Meaning
HIGH	BAD, Comm_FAILURE
	BAD, NON_SPECIFIC
	UNCERTAIN, NON_SPECIFIC
LOW	GOOD
IGNORED	BAD, OUT_OF_SERVICE

8.12.2 OPC-AE Message Data

OPC-AE Message Names and Meaning

Name	Meaning
Source of the message	Chain of tags separated by dots: FDS.PORT.HD2-DM-A.SEGMENT
Type	CONDITION_BASED_EVENT
EventCategory	Pepperl+Fuchs ADM diagnostic condition
Severity	Weight of the alarm occurred
Message	Short description of the message occurred

Overview of the Message Content

Alarm Status	Message ID	Severity	Message Value
GOOD	0	101	Status returned to normal
Maintenance required	1005	701	Bulk power supply exceeds limits set during commissioning
	1004	701	Physical layer exceeds limits set during commissioning

2020-11

Alarm Status	Message ID	Severity	Message Value
Out of specification	2006	901	Bulk power supply exceeds specified limits or wrong motherboard used
	2007	901	Physical layer exceeds limits of the fieldbus specification
Hardware error	3000	301	ADM internal HW error
Communication error	4001	351	ADM did not answer
	4002	351	Port could not be opened
	4003	351	SK3 existing
Pending	-	-	Pending
Segment disabled	9000	251	-

OPC-AE Message Format

<Alarm Status>
 <Message ID>
 <Message Value>

Example:

Maintenance Required

1004

Bulk power supply exceeds limits set during commissioning.

Your automation, our passion.

Explosion Protection

- Intrinsic Safety Barriers
- Signal Conditioners
- FieldConnex® Fieldbus
- Remote I/O Systems
- Electrical Ex Equipment
- Purge and Pressurization
- Industrial HMI
- Mobile Computing and Communications
- HART Interface Solutions
- Surge Protection
- Wireless Solutions
- Level Measurement

Industrial Sensors

- Proximity Sensors
- Photoelectric Sensors
- Industrial Vision
- Ultrasonic Sensors
- Rotary Encoders
- Positioning Systems
- Inclination and Acceleration Sensors
- Fieldbus Modules
- AS-Interface
- Identification Systems
- Displays and Signal Processing
- Connectivity

Pepperl+Fuchs Quality

Download our latest policy here:

www.pepperl-fuchs.com/quality

