

# H-System

## Isolated Barriers and Termination Boards

System Manual



Your automation, our passion.

 **PEPPERL+FUCHS**

---

With regard to the supply of products, the current issue of the following document is applicable:  
The General Terms of Delivery for Products and Services of the Electrical Industry, published by the Central Association of the Electrical Industry (Zentralverband Elektrotechnik und Elektroindustrie (ZVEI) e.V.) in its most recent version as well as the supplementary clause: "Expanded reservation of proprietorship"

### **Worldwide**

Pepperl+Fuchs Group  
Lilienthalstr. 200  
68307 Mannheim  
Germany  
Phone: +49 621 776 - 0  
E-mail: [info@de.pepperl-fuchs.com](mailto:info@de.pepperl-fuchs.com)

### **North American Headquarters**

Pepperl+Fuchs Inc.  
1600 Enterprise Parkway  
Twinsburg, Ohio 44087  
USA  
Phone: +1 330 425-3555  
E-mail: [sales@us.pepperl-fuchs.com](mailto:sales@us.pepperl-fuchs.com)

### **Asia Headquarters**

Pepperl+Fuchs Pte. Ltd.  
P+F Building  
18 Ayer Rajah Crescent  
Singapore 139942  
Phone: +65 6779-9091  
E-mail: [sales@sg.pepperl-fuchs.com](mailto:sales@sg.pepperl-fuchs.com)  
<https://www.pepperl-fuchs.com>

---

<b>1</b>	<b>Introduction</b> .....	<b>5</b>
1.1	Content of this Document .....	5
1.2	Target Group, Personnel .....	6
1.3	Symbols Used .....	6
<b>2</b>	<b>Product Specifications</b> .....	<b>7</b>
2.1	Function .....	7
2.2	Isolated Barriers .....	8
2.3	Termination Boards .....	12
<b>3</b>	<b>Mounting and Installation</b> .....	<b>19</b>
3.1	Termination Board Mounting .....	19
3.2	Isolated Barriers Mounting .....	21
3.3	Connection .....	23
<b>4</b>	<b>Commissioning</b> .....	<b>26</b>
4.1	Configuration of the Isolated Barriers .....	26
4.2	Device Coding .....	27
<b>5</b>	<b>Operation</b> .....	<b>29</b>
5.1	Fault Monitoring .....	29
5.2	Fault Output .....	30
5.3	Current and Voltage Standard Signals .....	31
<b>6</b>	<b>Dismounting, Maintenance, and Repair</b> .....	<b>32</b>
6.1	Isolated Barriers Dismounting .....	33
6.2	Termination Board Dismounting .....	34
<b>7</b>	<b>Technical Specifications</b> .....	<b>35</b>
7.1	Technical Data .....	35
7.2	Model Number Description .....	39
7.3	Dimensions .....	42



# 1 Introduction

## 1.1 Content of this Document

This document contains information that you need in order to use your product throughout the applicable stages of the product life cycle. These can include the following:

- Product identification
- Delivery, transport, and storage
- Mounting and installation
- Commissioning and operation
- Maintenance and repair
- Troubleshooting
- Dismounting
- Disposal



---

### Note

This document does not substitute the instruction manual.

---



---

### Note

For full information on the product, refer to the instruction manual and further documentation on the Internet at [www.pepperl-fuchs.com](http://www.pepperl-fuchs.com).

---



---

### Note

For specific device information such as the year of construction, scan the QR code on the device. As an alternative, enter the serial number in the serial number search at [www.pepperl-fuchs.com](http://www.pepperl-fuchs.com).

---

The documentation consists of the following parts:

- Present document
- Instruction manual
- Datasheet

Additionally, the following parts may belong to the documentation, if applicable:

- EU-type examination certificate
- EU declaration of conformity
- Attestation of conformity
- Certificates
- Control drawings
- Functional safety manual
- Additional documents

### 1.2 Target Group, Personnel

Responsibility for planning, assembly, commissioning, operation, maintenance, and dismantling lies with the plant operator.

Only appropriately trained and qualified personnel may carry out mounting, installation, commissioning, operation, maintenance, and dismantling of the product. The personnel must have read and understood the instruction manual and the further documentation.

Prior to using the product make yourself familiar with it. Read the document carefully.

### 1.3 Symbols Used

This document contains symbols for the identification of warning messages and of informative messages.

#### Warning Messages

You will find warning messages, whenever dangers may arise from your actions. It is mandatory that you observe these warning messages for your personal safety and in order to avoid property damage.

Depending on the risk level, the warning messages are displayed in descending order as follows:



---

#### Danger!

This symbol indicates an imminent danger.

Non-observance will result in personal injury or death.

---



---

#### Warning!

This symbol indicates a possible fault or danger.

Non-observance may cause personal injury or serious property damage.

---



---

#### Caution!

This symbol indicates a possible fault.

Non-observance could interrupt the device and any connected systems and plants, or result in their complete failure.

---

#### Informative Symbols



---

#### Note

This symbol brings important information to your attention.

---



---

#### Action

This symbol indicates a paragraph with instructions. You are prompted to perform an action or a sequence of actions.

## 2 Product Specifications

### 2.1 Function

Isolated barriers are used to protect intrinsically safe circuits in explosive areas. In addition to the required current, voltage and power limitation, the isolated barriers have a galvanic isolation between the field circuit and the controller.

The H-System isolated barriers are mounted on termination boards. Pre-wiring is possible on termination boards. To close the signal circuit, the isolated barriers are simply plugged in. The isolated barriers can be replaced during live operation when the wiring is connected.

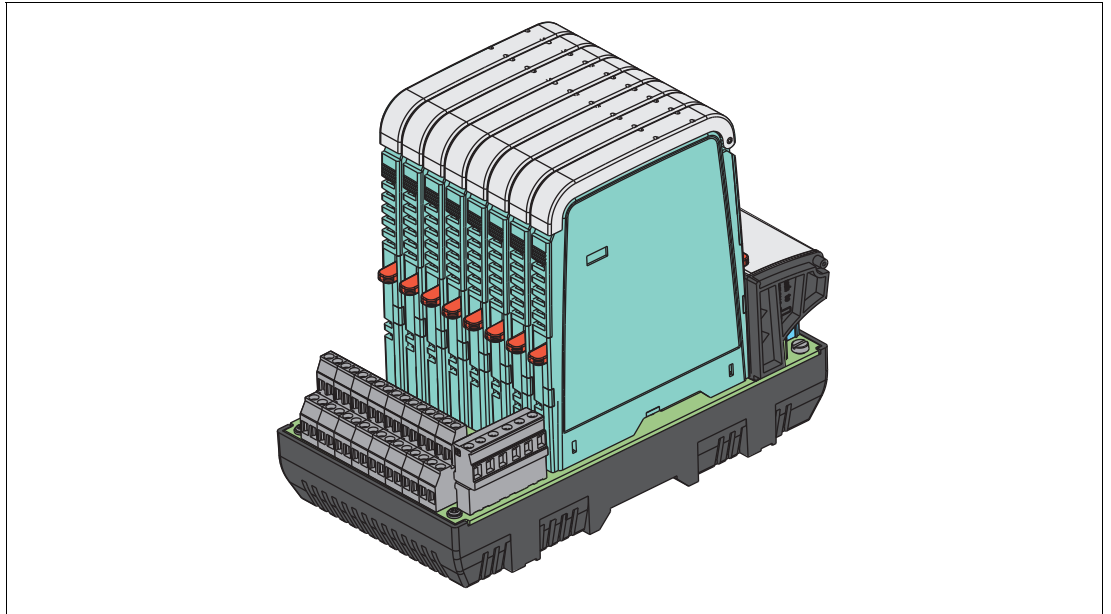

Figure 2.1 Generic H-System termination board with isolated barriers

Generic and control-system specific termination boards are available in the H-System. Termination boards can be adapted to specific input/output requirements. These requirements can be implemented via

- Various connecting plugs to the controller
- Various terminals to the field device
- A large selection of isolated barriers

### 2.2 Isolated Barriers

H-System isolated barriers cover all functions and the interoperability of the H-System.

The pin assignment and terminal designations are consistent for all termination boards. Each H-System isolated barrier can therefore be mounted in each termination board slot.

The termination board can be coded together with the isolated barriers. This prevents the isolated barriers being mixed up on the termination board. The safety-relevant data for the connected field devices is backed up.

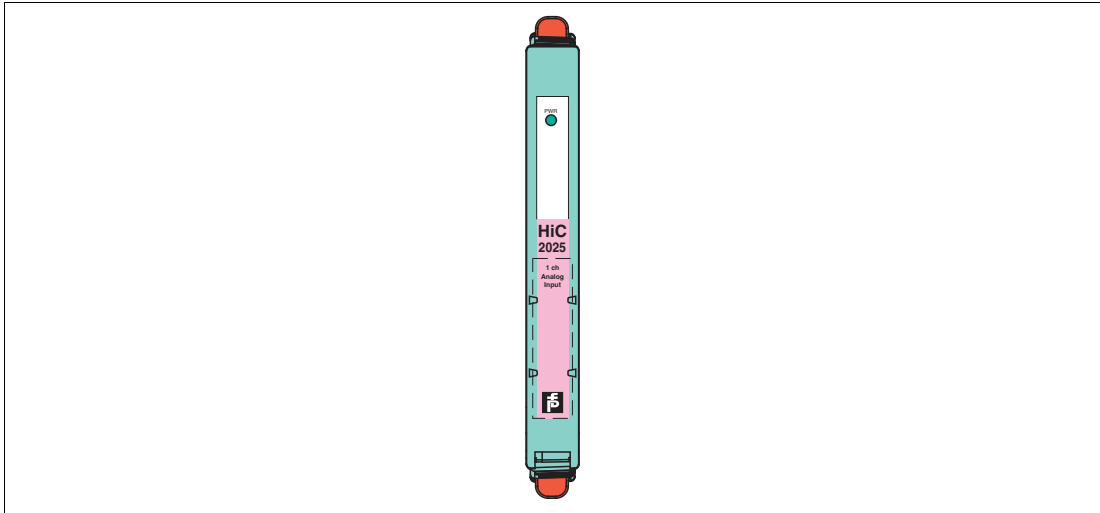

Figure 2.2 HiC device housing (12.5 mm)

#### Transparent Front Flap

The isolated barriers have a transparent front flap.

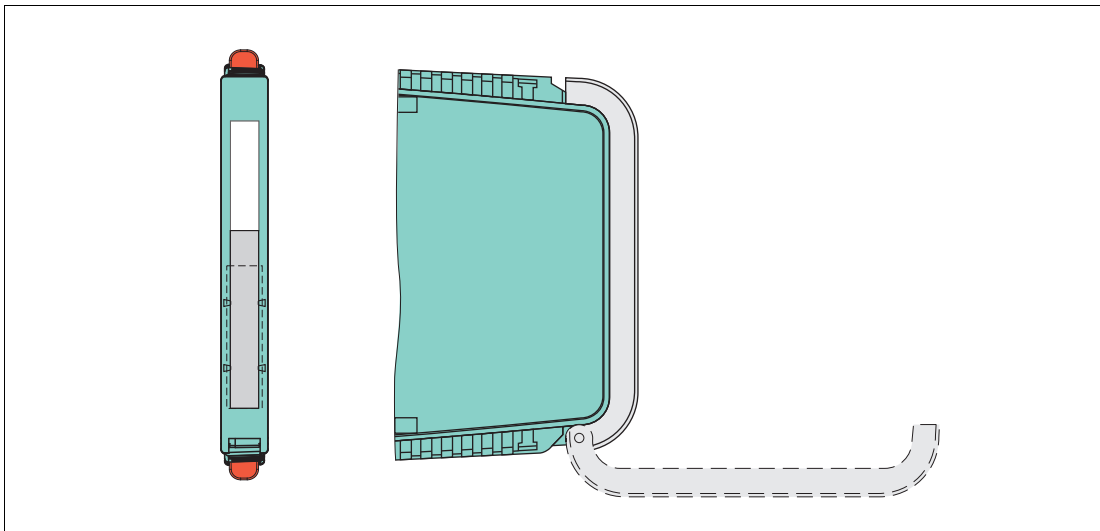

Figure 2.3 Transparent front flap for KC and KF devices, example

This front flap has 2 functions:

- Protection of the device against electrostatic discharge
- Integrated label carrier for individual labeling, see chapter 2.2.3



### 2.2.1 Color Coding of the Isolated Barriers

The color coding of the devices has the following meaning:

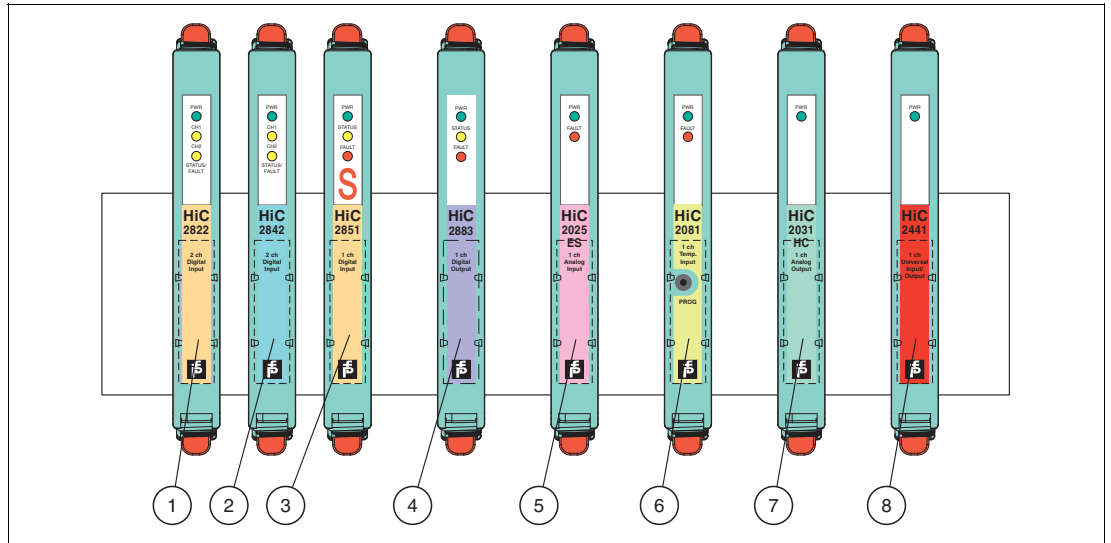

Figure 2.4 Color identification of devices

- 1 Digital input – switch amplifier with relay output
- 2 Digital input – switch amplifier with transistor output
- 3 Digital input – switch amplifier with transistor output and active voltage output for safety sensors SN, S1N
- 4 Digital output – solenoid driver, relay module
- 5 Analog input – transmitter power supply, converter, repeater
- 6 Temperature input – temperature converter
- 7 Analog output – current driver
- 8 Universal input/output – universal barrier

### 2.2.2 Status Indications of the Isolators

LEDs are often used on isolators to indicate different statuses (e. g. for power supply, device failure, status messages, binary switching states). Standard LED colors are assigned to the status indication according to NAMUR NE44.

LED	Display function	Display	Meaning
Green LED	Power supply	On	Power supply OK
		Off	No power supply or insufficient power supply – device faulty
Red LED	Device fault, device failure	On	Internal fault signal, failure signal – fault/failure display of causes detected inside the device, device needs replacing
	Line fault	Flashing	External fault signal, failure signal – fault/failure display of causes detected outside the device, inspection and elimination of fault required
	No fault	Off	No malfunction, device is operating properly
Yellow LED	Switching states of binary inputs and outputs	On	Possible causes of the output: <ul style="list-style-type: none"> <li>• The relay is energized.</li> <li>• The NO contact (also a change-over contact) is actively closed.</li> <li>• The open collector is switched through.</li> <li>• The switching voltage generated inside the device is applied.</li> </ul> Possible causes of the input: <ul style="list-style-type: none"> <li>• A binary switching signal is present.</li> <li>• An analog limit value is reached.</li> </ul>
		Off	Possible causes of the output: <ul style="list-style-type: none"> <li>• The relay is de-energized.</li> <li>• The NO contact (also a change-over contact) is actively opened.</li> <li>• The open collector is not switched through.</li> <li>• The switching voltage generated inside the device is not applied.</li> </ul> Possible causes of the input: <ul style="list-style-type: none"> <li>• A binary switching signal is present.</li> <li>• An analog limit value is reached.</li> </ul>

Table 2.1 Meaning of status indications

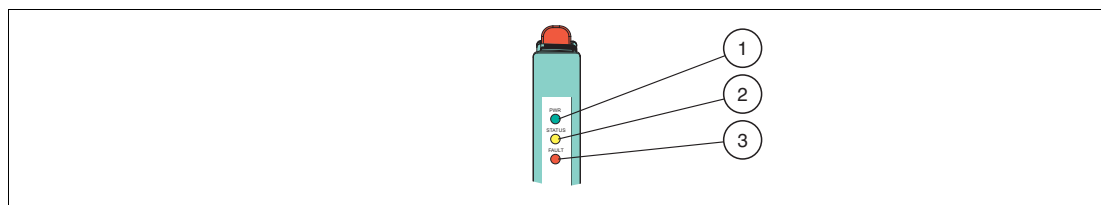

Figure 2.5 Example status indications

- 1 Green LED **PWR**  
Power supply status indication
- 2 Yellow LED **STATUS**  
Switching state of the output
- 3 Red LED **FAULT**  
Lead breakage and short circuit status indication

DOCT-0950S 2024-02

### 2.2.3 Label Carriers

The isolated barriers are fitted with a label carrier ex works for individual identification.

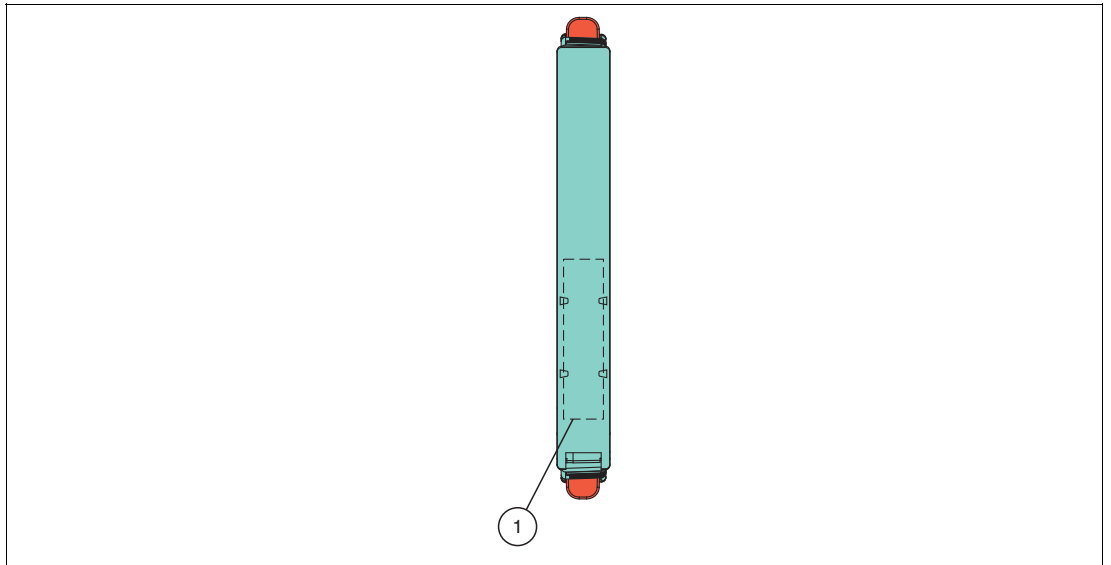

Figure 2.6 Label carrier on the front

- 1 Label carrier for 35 mm x 10.5 mm labels

### 2.3 Termination Boards

Termination boards form the wiring level for field and control signals. The isolated barriers are mounted on termination boards. The isolated barriers are connected with the field and control side via the termination boards. Once the isolated barrier is mounted, the signal circuit between the field and control side is closed.

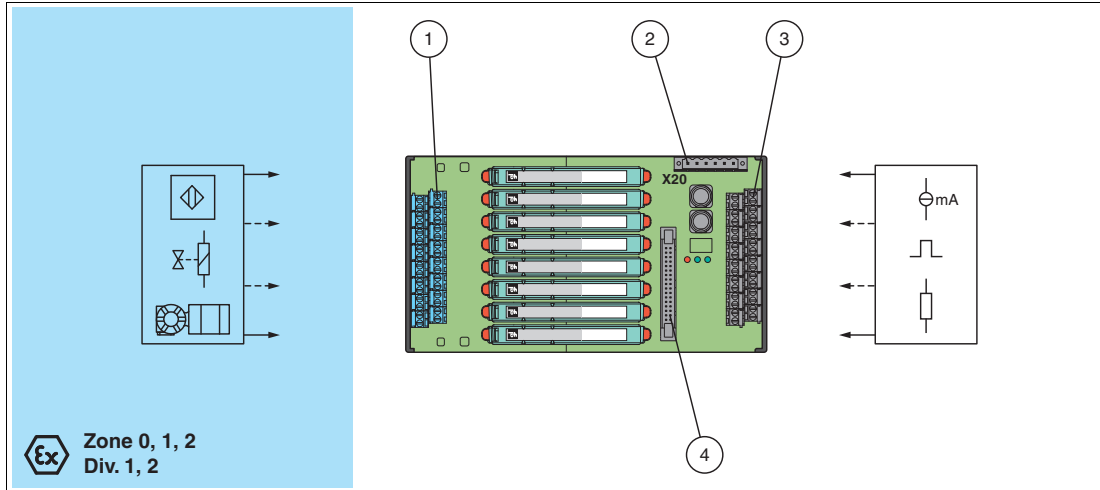

Figure 2.7 Connection example termination board with 8 slots

- 1 Field side connection
- 2 Connection power supply and fault indication output
- 3 Control side connection
- 4 Connection HART communication (if available)

Features depending on version

- With 8, 16, or 32 slots
- For redundant and fused power supply
- For fault monitoring and diagnostics

### 2.3.1 Connection Options

A variety of termination boards is available with different methods of connecting to the field and control side. Please refer to the documentation for the respective device for the specific connection layout.

#### Connecting the Field Side

The field devices can be connected to the termination board with the following connection options:

##### Screw terminals

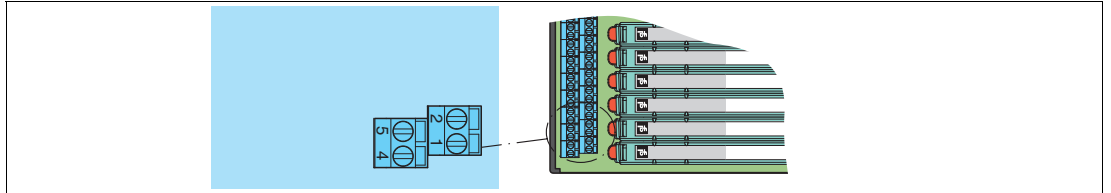

Figure 2.8 Connection example: field-side screw terminals

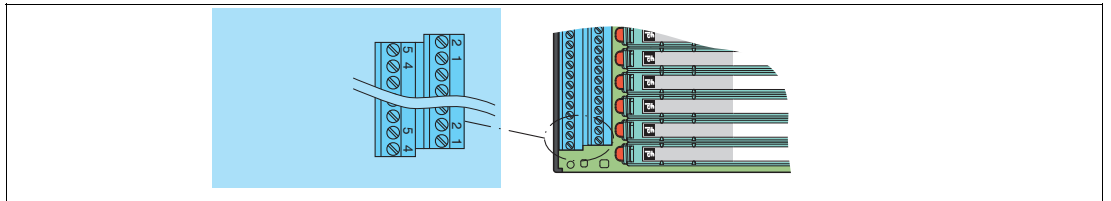

Figure 2.9 Connection example: field-side pluggable screw terminals

##### Spring terminals

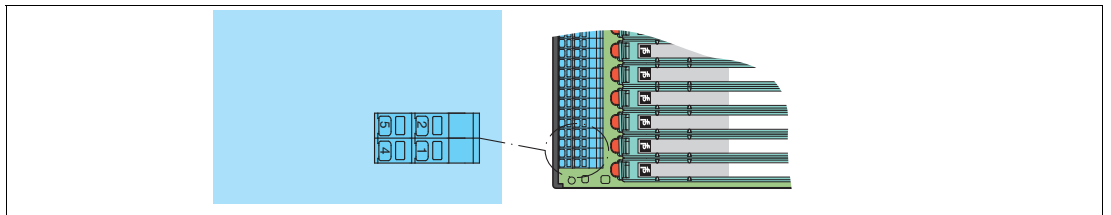

Figure 2.10 Connection example: field-side spring terminals

#### Connecting the power supply and Fault Indication Output

##### Isolated barriers

The isolated barriers are supplied via the termination board. The isolated barriers are therefore attached to the termination board.

##### Termination boards

The termination boards are supplied via pluggable screw terminals or spring terminals.

The supply voltage range depends on

- The values used for the isolated barriers
- The voltage drop of the decoupling diodes on the termination board

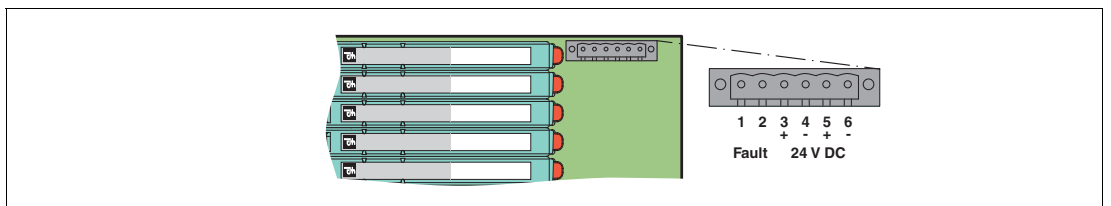

Figure 2.11 Connection example of power supply and fault indication output

### Connecting the Control Side

The termination board on the control side can be connected via the following connection options:

#### Screw terminals

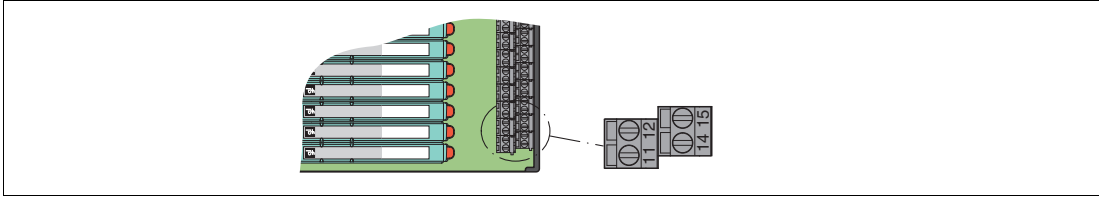

Figure 2.12 Connection example: control-side screw terminals

#### Spring terminals

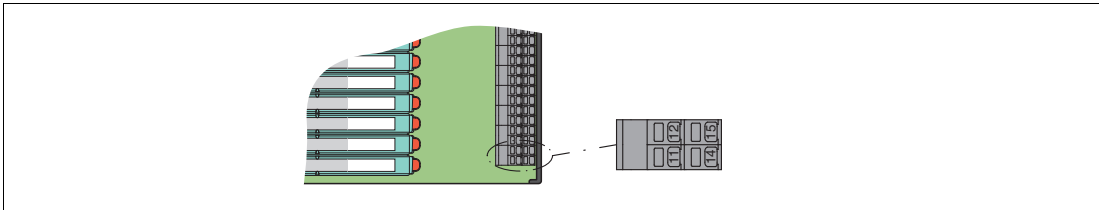

Figure 2.13 Connection example: control-side spring terminals

#### Sub-D plug

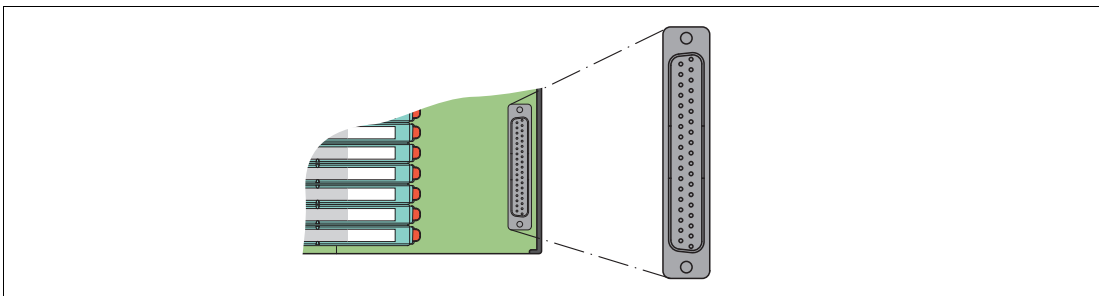

Figure 2.14 Connection example: control-side Sub-D plugs

#### Control-system specific plug

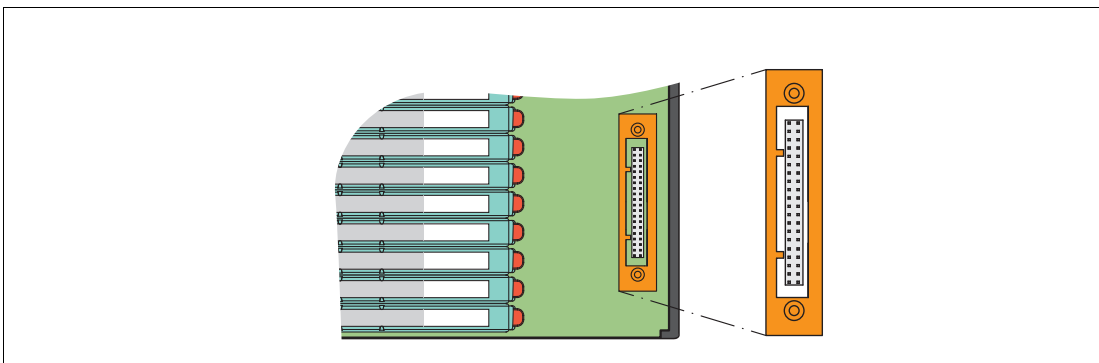

Figure 2.15 Connection example: control-side system plugs

### Establishing the HART Communication

Establish the HART communication via HART plug and HART multiplexer.

#### HART plug

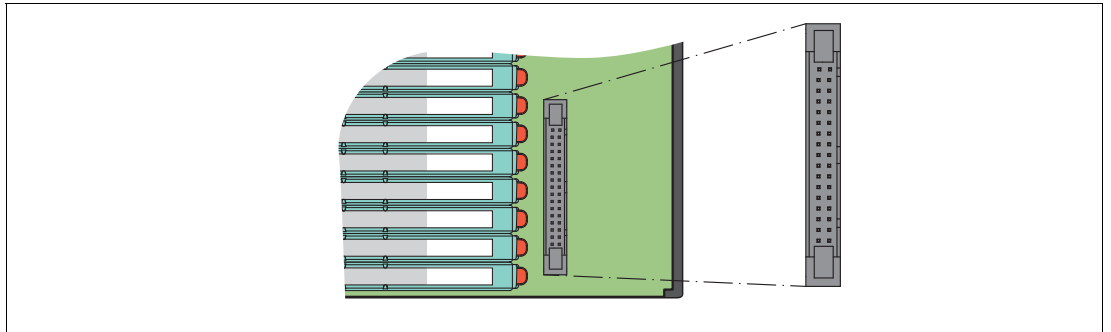

Figure 2.16 Connection via control-side HART plug

#### HART multiplexer

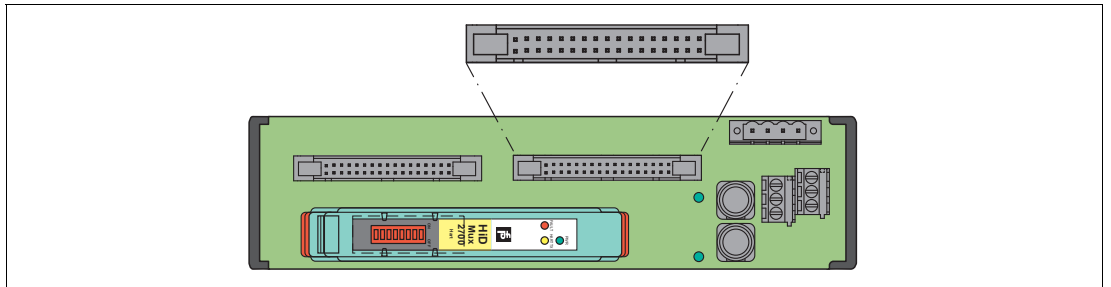

Figure 2.17 HART multiplexer connection



#### Note

See corresponding datasheets for further information.



#### Note

See corresponding system descriptions of the control system manufacturer for further information.

### 2.3.2 Status Indicators of Termination Boards

LEDs are often used on termination boards to indicate different statuses (e. g. for power supply, device failure, status messages). Standard LED colors are assigned to the status display according to NAMUR NE 44.

LED	Display function	Display	Meaning
Red LED <b>FAULT</b>	Device fault	On	Module fault, module failure
	Power supply failure	Flashing	Power supply failure
Green LED <b>PWR2</b>	Power supply II	On	Power supply OK
		Off	No power
Green LED <b>PWR1</b>	Power supply I	On	Power supply OK
		Off	No power

Table 2.2 Meaning of status indicators

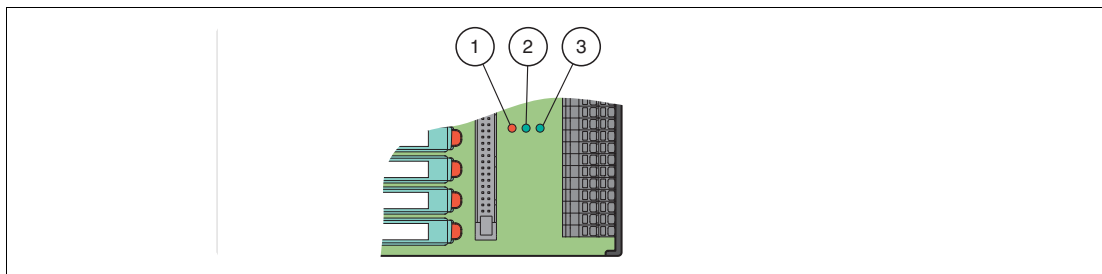

Figure 2.18 Example status indicators

- 1 Red LED **FAULT**  
Module fault, module failure, power supply failure
- 2 Green LED **PWR2**  
Status indicator power supply II
- 3 Green LED **PWR1**  
Status indicator power supply I

**Note**

See corresponding system descriptions of the control system manufacturer for further information.





### 2.3.3 Accessories

#### Label Carriers for Termination Boards

The termination boards can be fitted with a label carrier for individual identification.

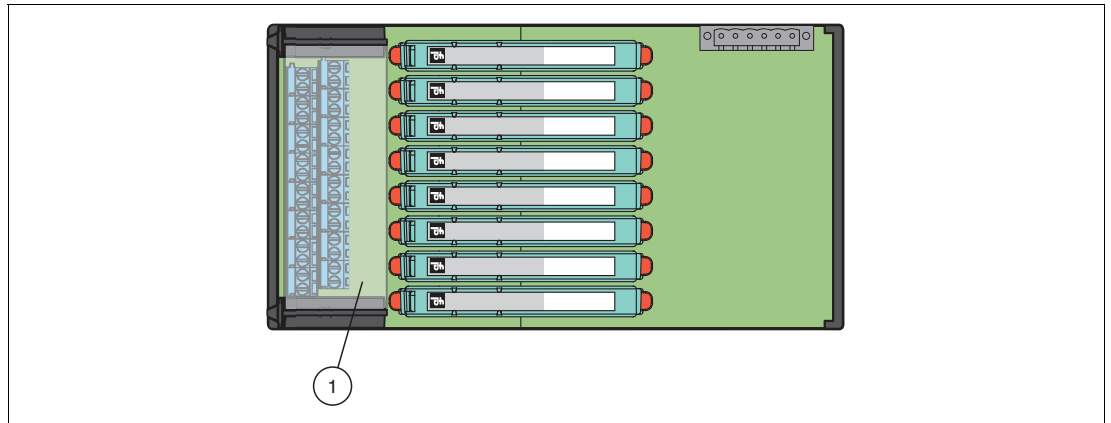

Figure 2.19 Label carrier for termination boards

- 1 Label carrier HiALC-HiCT\*-SET-\*\*\* for HiC termination boards

#### HART Communication Board

The HART Communication Board is connected to HART-compatible H-System termination boards. It has one slot to mount a 32-channel HiD Mux2700-type HART multiplexer main device.

Preconfigured HART connection cables enable easy connection between the H-System termination boards and the HART Communication Board.

The device offers a redundant fused power supply with an LED indicator.

The RS 485 terminals have a redundant configuration and enable simple bridging to the next bus node.

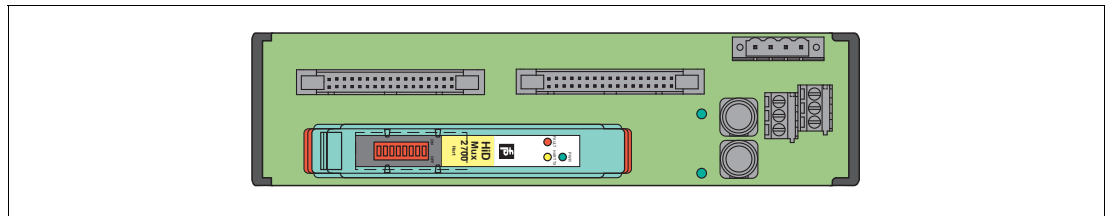

Figure 2.20 HART Communication Board HiATB01-HART-2x16

#### Application Example

The following diagram shows a typical example of an application with a HART Communication Board.

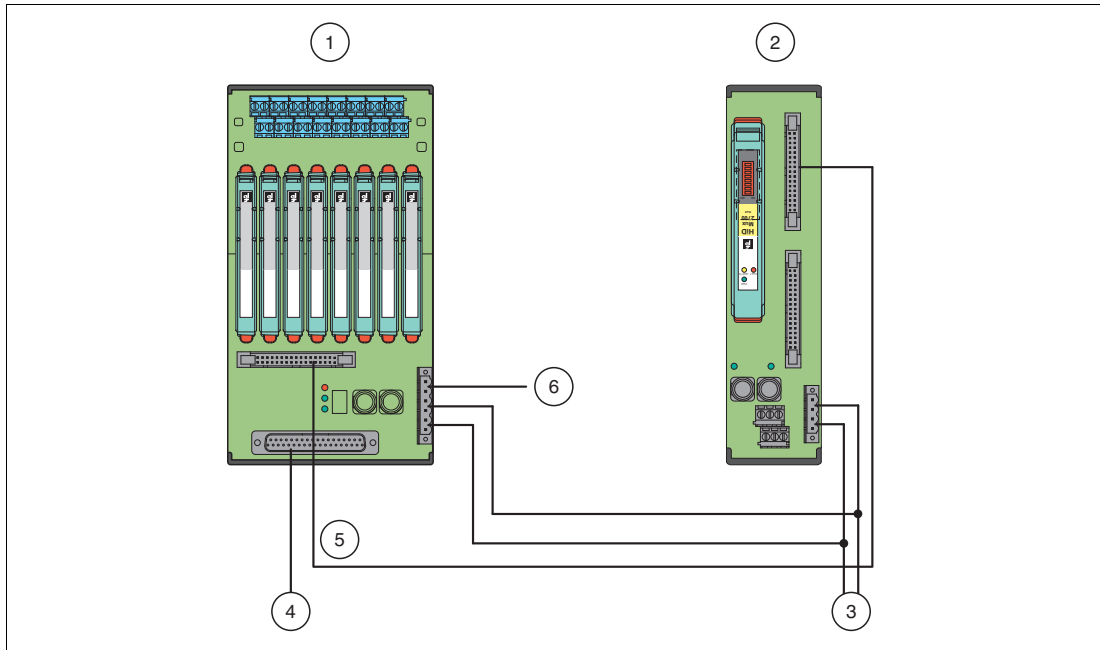

Figure 2.21 H-System topology

- 1 Termination board
- 2 HART Communication Board
- 3 Connection power supply I and II (redundant)
- 4 Connection control side
- 5 Connection HART communication
- 6 Connection fault indication output

### 2.3.4 DIN Mounting Rail, on the User Side

The termination boards are mounted on a 35 mm DIN mounting rail according to EN 60715.

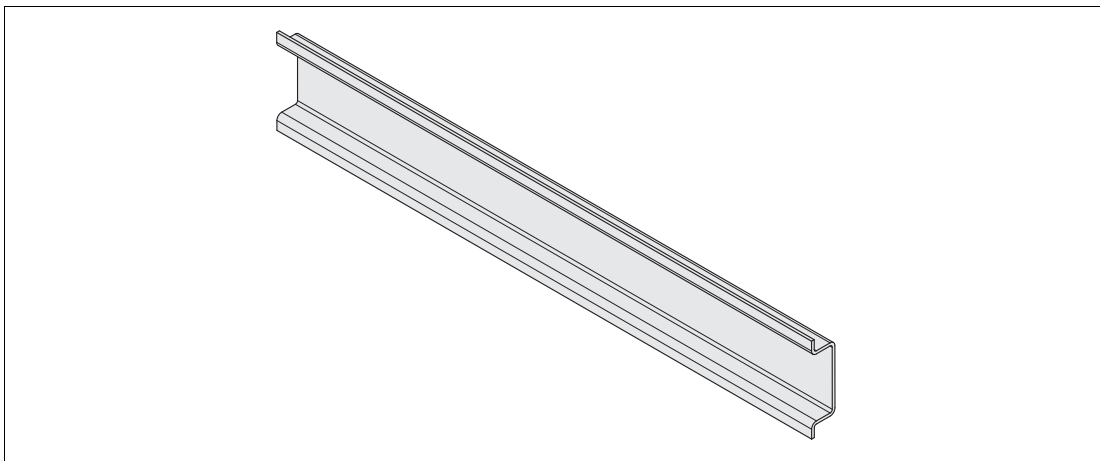

Figure 2.22 Example: DIN mounting rail (35 mm x 7.5 mm)

### 3 Mounting and Installation

**Danger!**

Explosion hazard from damaged electronic components

Premature wear of electronic components in a device that was previously used in a general electrical installation can cause sparks that can ignite the surrounding potentially explosive atmosphere.

Never install devices that have already been operated in general electrical installations in electrical installations used in combination with hazardous areas!

---

**Danger!**

Explosion hazard from pollution

An excessively polluted surface of the device can become conductive and consequently ignite a surrounding potentially explosive atmosphere.

Ensure that you install the device only in environments with a pollution degree 2 or better according to IEC/EN 60664-1.

---

#### 3.1 Termination Board Mounting

**Warning!**

Risk of short circuit

Working on live parts can cause injuries and can compromise the function and the electrical safety of the device.

- Before working on the device, always disconnect the supply voltage.
  - Connect the device to the supply voltage only after completion of the work.
-



### Mounting the Termination Boards

The termination boards are mounted on the 35 mm DIN mounting rail. The DIN mounting rail runs centrally below the termination board.

1. Clip the termination board (2) onto the DIN mounting rail (1).
2. Tighten the mounting screws (3).

↳ The termination board (2) is now properly mounted and secured.

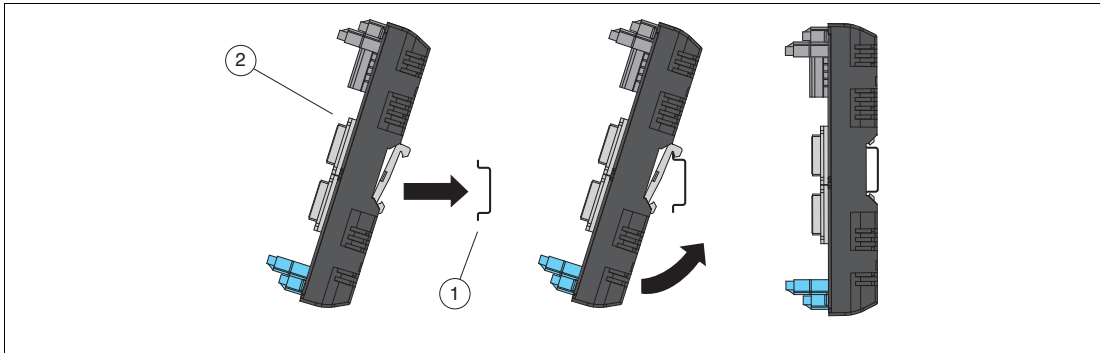

Figure 3.1 Termination board mounting

- 1 DIN mounting rail
- 2 Termination board

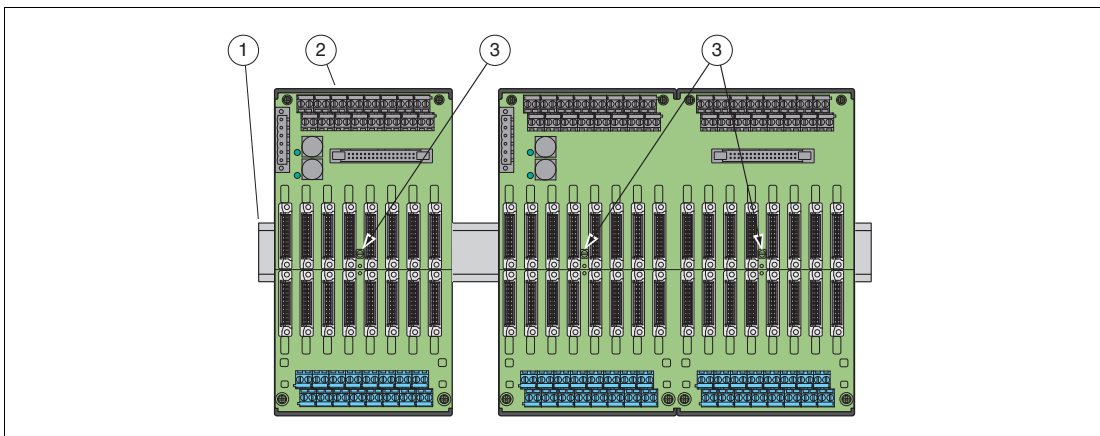

Figure 3.2 Termination board fixing

- 1 DIN mounting rail
- 2 Termination board
- 3 Fastening screws

### Vertical and Horizontal Mounting

Both mounting options are possible. Unrestricted operation is possible across the entire temperature range of the system in each mounting direction.

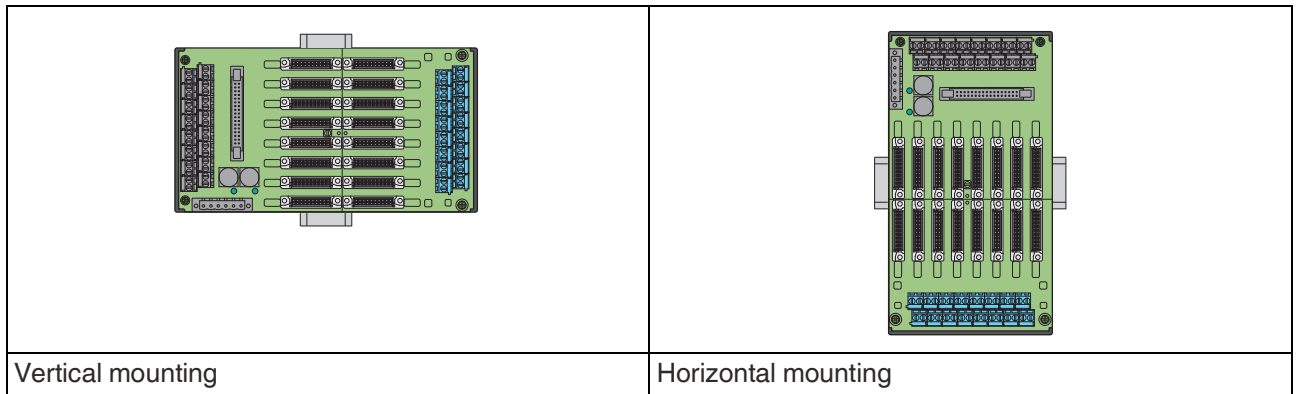

Figure 3.3

## 3.2 Isolated Barriers Mounting

### Mounting in the Non-Hazardous Area



#### Mounting the Isolated Barriers on the Termination Board

Mount the barrier as described in the following section. See Figure 3.4

### Mounting in Areas that Require the Equipment Protection Level Gc



#### Danger!

Explosion hazard from insufficient type of protection

The usage of modules with termination boards with insufficient type of protection can cause sparks or other hazards for potentially explosive atmospheres that can ignite the surrounding atmosphere.

Only use the modules in the hazardous area if the termination boards are also approved for the hazardous area.



#### Danger!

Explosion hazard from live wiring of non-intrinsically safe circuits

If you connect or disconnect energized non-intrinsically safe circuits in a potentially explosive atmosphere, sparks can ignite the surrounding atmosphere.

Only connect or disconnect energized non-intrinsically safe circuits in the absence of a potentially explosive atmosphere.



#### Danger!

Explosion hazard from wrong mounting

The device safety can be impaired by external environmental influences and by mechanical stress. That can lead to sparking that can ignite a surrounding potentially explosive atmosphere.

Mount the device in a surrounding enclosure that complies with IEC/EN 60079-0 and that is rated with the degree of protection IP54 according to IEC/EN 60529.



### Mounting the Isolated Barriers on the Termination Board

1. Push the Quick Lok bar (1) into the upper position.
2. Center the pins (2) above the contact elements of the termination board. Note the connection direction of the device.
3. Center the locking pins (3) above the locking elements of the termination board.
4. Carefully push the device into the contacts and locking elements.
5. Push the red Quick Lok bar (1) down on either side of the device.

↳ The device is now mounted.

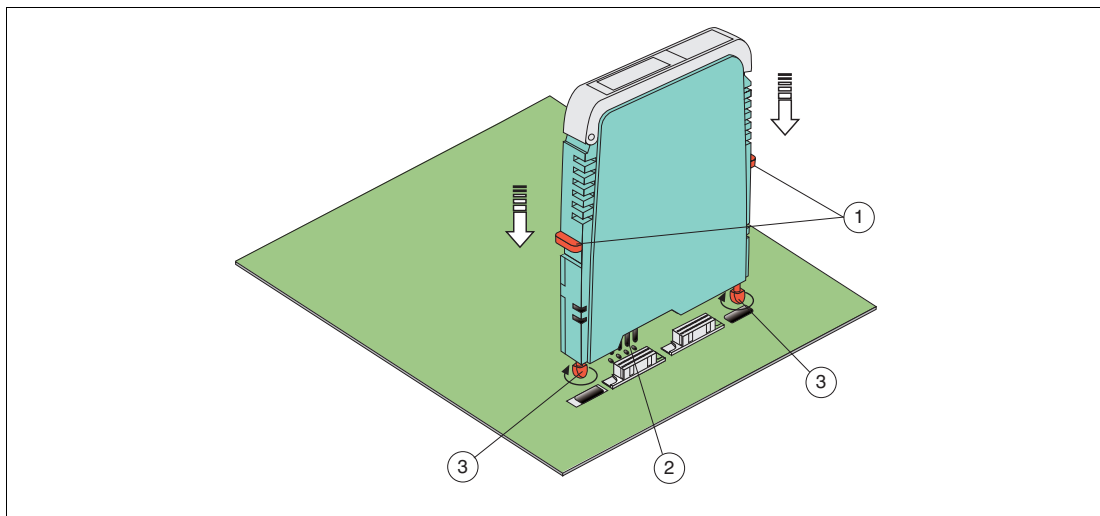

Figure 3.4 Mounting of an H-System isolated barrier

- 1 Quick Lok Bar
- 2 Coding pins
- 3 Adjustment pins

### 3.3 Connection

**Danger!**

Explosion hazard from live wiring of non-intrinsically safe circuits

If you connect or disconnect energized non-intrinsically safe circuits in a potentially explosive atmosphere, sparks can ignite the surrounding atmosphere.

Only connect or disconnect energized non-intrinsically safe circuits in the absence of a potentially explosive atmosphere.

---

**Danger!**

Danger to life from electric shock

Absent or insufficient insulation can result in electric shock.

- Maintain sufficient distance between the connection lines, terminals, surrounding enclosure, and the environment.
  - Insulate connection lines, terminals, and the surrounding enclosure from the environment.
- 

**Danger!**

Danger to life from incorrect installation

Incorrect installation of cables and connection lines can compromise the function and the electrical safety of the device.

- Observe the permissible core cross section of the conductor.
  - When using stranded conductors, crimp wire end ferrules on the conductor ends.
  - Use only one conductor per terminal.
  - When installing the conductors the insulation must reach up to the terminal.
  - Observe the tightening torque of the terminal screws.
- 

**Danger!**

Explosion hazard from exposed conductors

Exposed conductors of inadequately attached cables can cause sparks that can ignite the surrounding potentially explosive atmosphere.

When installing the device ensure that the cables are adequately attached.

---

**Caution!**

Property damage from use of inappropriate tool

Using an inappropriate tool may damage the screw heads.

- Use a slot-head screwdriver with a size of 3.5 x 0.5.
  - Observe the tightening torque of the terminal screws.  
The tightening torque is 0.5 Nm to 0.6 Nm.
-

### Connecting the Field Side

---

**Danger!**

Explosion hazard from wrong separation distances

If you do not observe the minimum separation distance between 2 intrinsically safe circuits, this can lead to added currents or voltages. This can result in a current/voltage flashover generating sparks. The sparks can ignite the surrounding potentially explosive atmosphere.

Ensure that you observe all separation distances between 2 adjacent intrinsically safe circuits according to IEC/EN 60079-14.

---

**Danger!**

Explosion hazard from wrong separation distances

If you do not observe the minimum separation distances between intrinsically safe circuits of associated apparatus and non-intrinsically safe circuits, this can lead to added currents or voltages. This can result in a current/voltage flashover generating sparks. The sparks can ignite the surrounding potentially explosive atmosphere.

Ensure that you observe the compliance of the separation distances to all non-intrinsically safe circuits according to IEC/EN 60079-14.

---

Connect the field devices to the termination board via the screw terminals or spring terminals.

### Connecting the Power Supply and Fault Indication Output

---

**Danger!**

Danger to life from electric shock

Absent or insufficient insulation can result in electric shock.

Only connect supplies that provide protection against electric shock (e. g. SELV or PELV).

---

Connect the power supply and fault indication output via the screw terminals or spring terminals.



### Connecting the Control Side

---



#### **Danger!**

Danger to life from electric shock

Absent or insufficient insulation can result in electric shock.

Only connect circuits that provide protection against electric shock (e. g. SELV or PELV).

---



#### **Warning!**

Risk of short circuit

Live working can cause injuries to the operator and/or damage to the device.

Disconnect the device, before you plug or unplug the plugs.

---

Connect the Termination Board on the control side via the following connection options:

- Screw terminals
- Spring terminals
- Sub-D plug
- Control-system specific plug

### Establishing the HART Communication

Establish the HART communication via HART plug and HART multiplexer on the control side.



### Connecting Circuits

1. Connect the field circuit.
2. Connect the control circuit.
3. Connect the power supply.
4. Establish the HART communication.



#### **Note**

See corresponding datasheets for further information.

---

## 4 Commissioning

### 4.1 Configuration of the Isolated Barriers

---



#### **Danger!**

Explosion hazard from sparking when using operating elements

Using operating elements in a potentially explosive atmosphere can cause sparks that can ignite the surrounding atmosphere.

Only use operating elements (e. g., switch, slider, button, etc.) in the absence of a potentially explosive atmosphere.

---



#### **Caution!**

Fault in the plant

Changing the device data changes the device function.

Before entering new device data, make sure the plant is not endangered by changing the device data.

---



#### **Caution!**

Potential device malfunction due to electrostatic discharge

An electrostatic discharge may occur while you are operating the device. This can lead to malfunction of the device. As a result, the function or safety function of the device is no longer guaranteed.

- Ground yourself or provide yourself with an adequate equipotential bonding before operating the device.
  - Only open the front flap while you are operating the device. Otherwise, keep the front flap closed.
- 

The devices are configured using DIP switches.



#### **Configuring the Isolated Barrier**

Set the DIP switches on the device side as follows:

1. Remove the isolated barriers from the termination board as described in the **Dismounting** section.
  2. Set the DIP switches as described in the **Configuration** section of the datasheet.
  3. Mount the device as described in the **Mounting** section.
- 



#### **Note**

See corresponding datasheets for further information.

---

## 4.2 Device Coding

The isolated barriers are factory coded depending on their function. The coding is realized by trimmed and untrimmed pins. It is possible to code the slots on the termination board according to the module coding. The necessary coding pins are supplied with the termination boards. The coding pins can also be ordered as accessories, model number H-CP.

The following table shows the pin assignment between isolated barriers and termination boards.

### Device Coding of HiC Devices and HiC Termination Boards

No.	Termination board Top view		Isolated barrier Bottom view		Type
	Safe area	Hazardous area	Hazardous area	Safe area	
A					all non-intrinsically safe devices, e. g. HiC5861(Y1), HiC5863(Y1)
B					–
C					HiC2095
D					–
E					HiC2025HC
F					HiC2821, HiC2822, HiC2831(R*), HiC2832(R*), HiC2841, HiC2842, HiC2851, HiC2853(R*)
G					HiC2025(Y1), HiC2025ES, HiC2031, HiC2031ES, HiC2422
H					HiC2441, HiC2871, HiC2871A, HiC2873(Y1), HiC2883
I					HiC2025A, HiC2027, HiC2027DE, HiC2027ES, HiC2877
J					HiC2031HC
K					–
L					–
M					HiC2081

DOCT-0950S 2024-02





No.	Termination board Top view		Isolated barrier Bottom view		Type
	Safe area	Hazardous area	Hazardous area	Safe area	
N					HiC2077
O					HiC2065, HiC2068
P					HiC2000 BLANK
	<ul style="list-style-type: none"> <li>● Coding pin inserted</li> <li>○ Coding pin not inserted</li> </ul>		<ul style="list-style-type: none"> <li>+ Pin trimmed</li> <li>○ Pin not trimmed</li> </ul> <p><b>Device side view</b></p> 		

Table 4.1

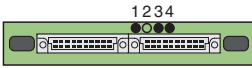
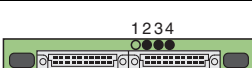
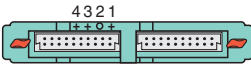

### Note

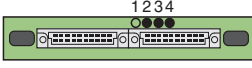
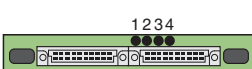
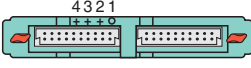
See corresponding datasheets for further information.

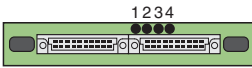
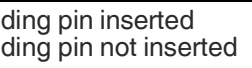
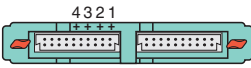
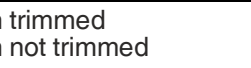
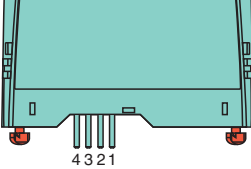
### 5 Operation

**Danger!**

Explosion hazard from live wiring of non-intrinsically safe circuits

If you connect or disconnect energized non-intrinsically safe circuits in a potentially explosive atmosphere, sparks can ignite the surrounding atmosphere.

Only connect or disconnect energized non-intrinsically safe circuits in the absence of a potentially explosive atmosphere.

---

**Danger!**

Explosion hazard from sparking when using operating elements

Using operating elements in a potentially explosive atmosphere can cause sparks that can ignite the surrounding atmosphere.

Only use operating elements (e. g., switch, slider, button, etc.) in the absence of a potentially explosive atmosphere.

---

**Caution!**

Potential device malfunction due to electrostatic discharge

An electrostatic discharge may occur while you are operating the device. This can lead to malfunction of the device. As a result, the function or safety function of the device is no longer guaranteed.

- Ground yourself or provide yourself with an adequate equipotential bonding before operating the device.
  - Only open the front flap while you are operating the device. Otherwise, keep the front flap closed.
- 

### 5.1 Fault Monitoring

Numerous faults can occur between measurement of the process variable and evaluation in the control system. This can lead to undesirable process statuses under certain circumstances. These process statuses may result in plant downtime or quality problems or even present a hazard to persons and the environment. Depending on the device version, the isolators enable monitoring of the following faults:

- Line faults  
Here, the connection cables between the isolator, the field device and the control system are monitored for lead breakages or short circuits.
- Device faults  
The isolators are designed so that internal faults are detected and reported. In the case of a power failure, the outputs are switched to the de-energized state.

## 5.2 Fault Output

Several H-System isolators monitor the field cables for lead breakages and short circuits so that faults in the plant can be detected immediately. Line faults are prevented from being interpreted as signals.

Depending on the configuration of the devices, these faults are transmitted to the outputs at the control side and in separate fault indication outputs as additional information.

### Fault Indication Output

Line and device faults are transmitted if the device has a fault indication output (FAULT). The fault indication output is active in a normal state and inactive in a fault state (closed-circuit principle). It is impossible to reverse the detection direction of the fault indication output.

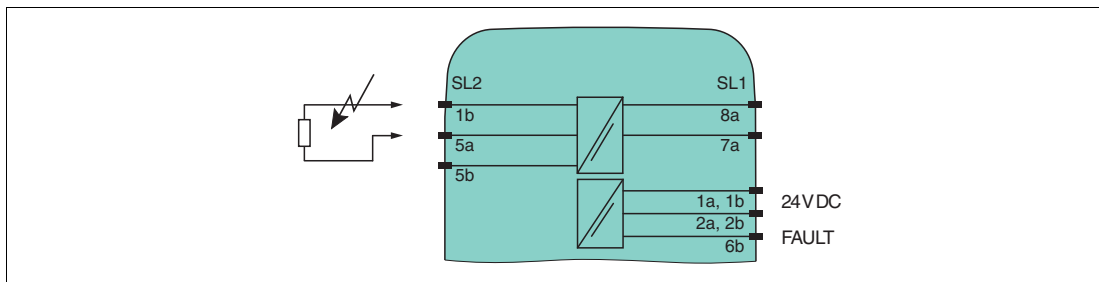

Figure 5.1

### Line Fault Transparency (LFT)

Line fault transparency makes electrical conditions on the field side visible on the control side of the isolator. This enables line faults between the isolator and the field device to be detected and transmitted to the control system via the signal line.

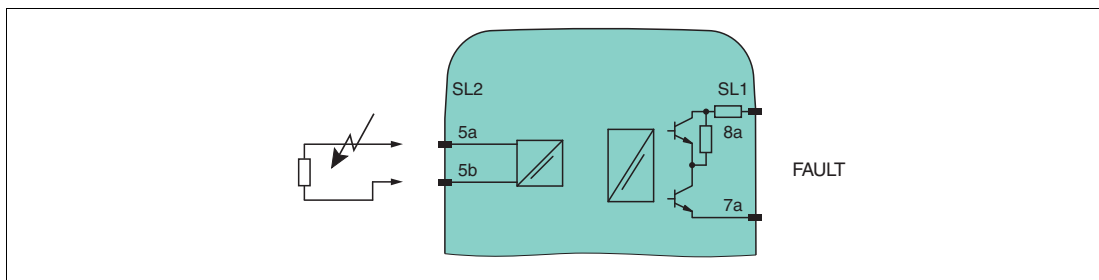

Figure 5.2 Example of line fault transparency with digital input

### Fault Signal on Termination Board

The majority of the termination boards have an internal fault signal.



#### Danger!

Explosion hazard from changing the fuse

The changing of the fuse under voltage can cause sparks. This can ignite the surrounding potentially explosive atmosphere.

De-energize the device before changing the fuse.

Information about a missing supply voltage of the termination board is available for the system as a volt-free contact.

Wiring errors from field side will be reported via the same relay contact, if this function supported by the isolators and the termination board.

### 5.3 Current and Voltage Standard Signals

The following signals have established themselves as the standard:

- the 0/4 mA to 20 mA current signal
- the 0/2 V to 10 V voltage signal
- the 0/1 V to 5 V voltage signal

Analog sensor signals and digital frequency signals are converted into one of the two standard signals for processing in a wide variety of measurement, regulatory and control tasks. This offers the measurement and control technician an easy-to-measure standard signal common to all manufacturers. Sensor signals are converted into standard signals via signal converters.

For more diagnostic options, the NAMUR organization published NAMUR recommendation NE43, dividing the value range of the signal (e. g. current signal) into several areas. Valid, defined measurement value information is transferred within the range from 3.8 mA to 20.5 mA. Failure information is available when the signal current is < 3.6 mA or > 21 mA i. e. outside of the range for measured value information. The same applies to the voltage signal.

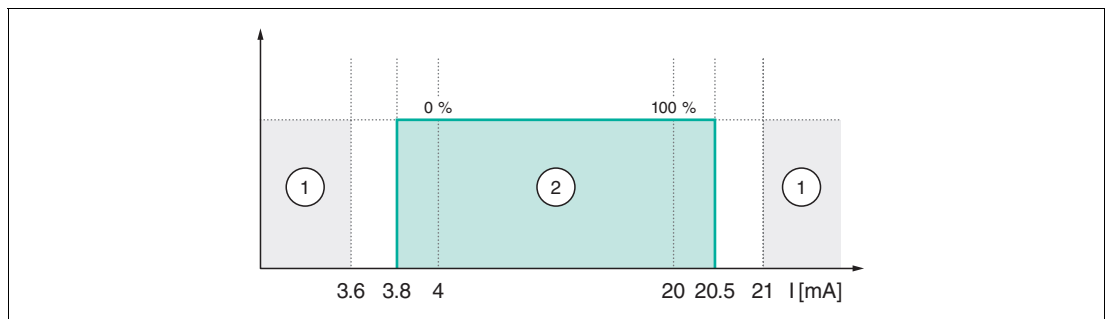

Figure 5.3 Signal ranges according to NAMUR NE43 (e. g. current signal)

- 1 Failure information
- 2 Measuring information

### 6 Dismounting, Maintenance, and Repair



---

**Danger!**

Danger to life from using damaged or repaired devices.

Using a defective or repaired device can compromise its function and its electrical safety.

- Do not use a damaged or polluted device.
  - The device must not be repaired, changed or manipulated.
  - If there is a defect, always replace the device with an original device from Pepperl+Fuchs.
- 



---

**Danger!**

Explosion hazard from live wiring of non-intrinsically safe circuits

If you connect or disconnect energized non-intrinsically safe circuits in a potentially explosive atmosphere, sparks can ignite the surrounding atmosphere.

Only connect or disconnect energized non-intrinsically safe circuits in the absence of a potentially explosive atmosphere.

---



---

**Danger!**

Explosion hazard from changing the fuse

The changing of the fuse under voltage can cause sparks. This can ignite the surrounding potentially explosive atmosphere.

De-energize the device before changing the fuse.

---



---

**Disconnecting Circuits**

1. Disconnect the power supply.
2. Disconnect the field circuit.
3. Disconnect the control circuit.



## 6.1 Isolated Barriers Dismounting



### Dismounting the Isolated Barrier from the Termination Board

1. Pull the Quick Lok bar (1) into the upper position.
2. Carefully pull out the device from the contacts and locking elements.

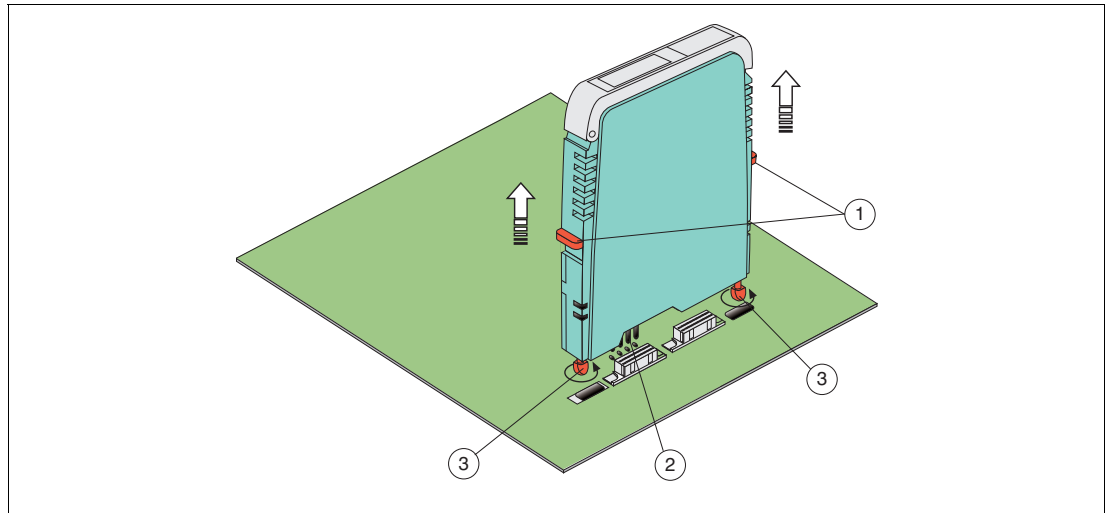

Figure 6.1 Dismounting of an H-System isolated barrier

- 1 Quick Lok Bar
- 2 Coding pins
- 3 Adjustment pins

## 6.2 Termination Board Dismounting



### Warning!

Risk of short circuit

Working on live parts can cause injuries and can compromise the function and the electrical safety of the device.

- Before working on the device, always disconnect the supply voltage.
- Connect the device to the supply voltage only after completion of the work.



### Dismounting the Termination Boards

1. Loosen the mounting screws (3).
2. Remove the termination board (2) from the DIN mounting rail (1).

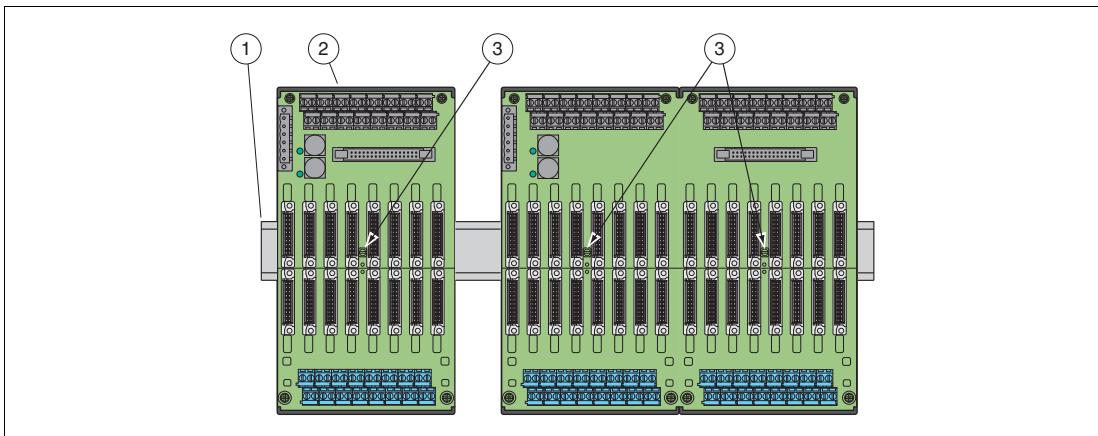

Figure 6.2 Termination board fixing

- 1 DIN mounting rail
- 2 Termination board
- 3 Fastening screws

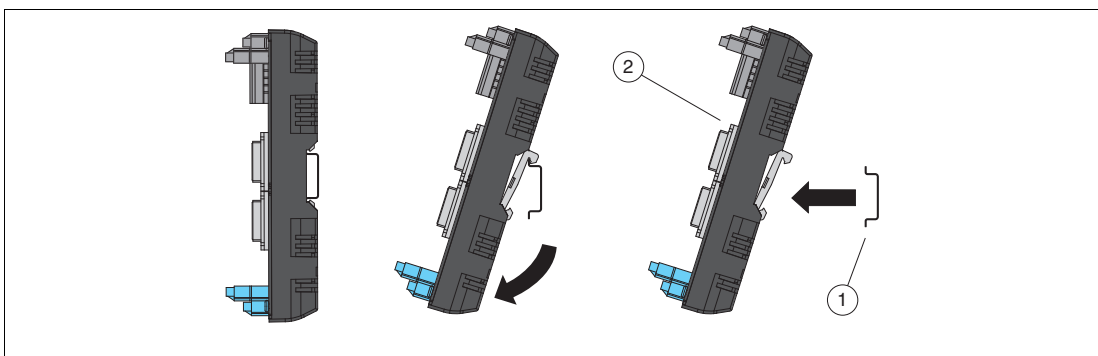

Figure 6.3 Termination board dismounting

- 1 DIN mounting rail
- 2 Termination board

## 7 Technical Specifications

### 7.1 Technical Data

#### Electrical Data

##### Power Supply to the Isolated Barriers

- 19 V DC to 30 V DC



##### Note

See corresponding datasheets for possible exceptions.

The voltage drop on the termination board via the decoupling diodes must be considered.

Each isolated barrier is internally protected. The termination boards have redundant power supply connections with fuses that can be replaced by the customer.

##### Non-Hazardous Area Signals or Control Circuit Signals

- 0/4 mA to 20 mA signal level according to NE 43
- 0/2 V to 10 V signal level according to NE 43
- 0/1 V to 5 V signal level according to NE 43
- Current output HART compatible
- Current input HART compatible
- Digital output: active or passive electronic output 100 mA/30 V, short-circuit protected
- Relay output 2 A, minimum load 1 mA/24 V
- Logic level 24 V according to IEC 60946
- Functional isolation or safe isolation according to IEC 61140 and NAMUR NE 23

##### Hazardous Area Signals or Signals in the Field Circuit

- Transmitter power supply up to 17 V DC
- Current output HART compatible
- Pt100, 2-, 3-, (4)-wire technology
- Resistor 0  $\Omega$  to 400  $\Omega$  with freely definable characteristic
- Potentiometer
- Thermocouples of all types, internal cold junction, external reference
- Current output HART compatible
- Digital input according to NAMUR EN 60947-5-6
- Digital output for standard Ex-i valves, short circuit-protected

##### Characteristic Safety Values

- MTBF: Mean Time Between Failures

### Conformity

#### General

- Isolated barriers with explosion protection, preferably Ex ia IIC/Class I, Div. 1, international approvals
- EMV according to
  - EN 61326-1
  - EN 61326-3-2, only for devices with SIL rating, where the datasheet mentions this standard.  
If you operate the device with a DC supply voltage, you must ensure that the bridging of the 20 ms voltage interruption is realized by the power supply.
  - NAMUR NE 21  
If you operate the device with a DC supply voltage, you must ensure that the bridging of the 20 ms voltage interruption is realized by the power supply.
- RoHS, refer to declaration of conformity of the respective device
- LEDs according to NAMUR NE 44
- Software according to NAMUR NE 53

#### Digital Inputs and Outputs according to NAMUR

- IEC/EN 60947-5-6: Low voltage switch gear and control gear – part 5 and 6: Control devices and switching elements – DC interface for proximity sensors and switch amplifiers (NAMUR), 1999

### Ambient Conditions

#### Ambient Temperature

- -20 °C to 60 °C (-4 °F to 140 °F), exceptions see datasheets

#### Storage Temperature

- -40 °C to 85 °C (-40 °F to 185 °F), exceptions see datasheets

#### Reference Conditions for Adjustment

- 20 °C (68 °F)

#### Relative Humidity

- max. 95 % without moisture condensation

#### Corrosive gas durability

- according to ISA-S71.04, group A, severity level G3 (harsh)

#### Altitude

- max. 2000 m

#### Vibration Resistance

- according to EN 60068-2-6, 10 Hz to 150 Hz, 1 g, high crossover frequency

#### Shock Resistance

- according to EN 60068-2-27, 10 g, 11 ms, half-sine

### Mechanical Data

#### Mounting

- Termination boards: Snap-on 35 mm DIN mounting rail according to EN 60715. Can be mounted horizontally or vertically.
- Isolated barriers: mounting on termination board via Quick Lok Bar

#### Housing Material

- Termination boards:
  - Polycarbonate (PC)
  - Polycarbonate (PC), glass fiber reinforced
- Isolated barriers: Polycarbonate (PC)

#### Dimensions

- Dimension drawings please refer to **Dimensions** section.

#### Degree of Protection

- Termination boards:
  - without isolated barriers IP00 according to EN 60529
  - with isolated barriers plugged IP20 according to EN 60529
- Isolated barriers: IP20 according to EN 60529

#### Connection to Termination Board

- Field side:
  - Screw terminals: 0.25 to 1.5 mm<sup>2</sup> (24 ... 12 AWG)  
Observe the tightening torque of the terminal screws. The tightening torque is 0.5 Nm to 0.6 Nm.
  - Pluggable screw terminals: 0.25 to 2.5 mm<sup>2</sup> (24 ... 12 AWG)  
Observe the tightening torque of the terminal screws. The tightening torque is 0.5 Nm to 0.6 Nm.
  - Spring terminals: 0.25 to 1.5 mm<sup>2</sup> (24 ... 12 AWG)
- Power supply and fault indication output:
  - Screw terminals: 0.25 to 1.5 mm<sup>2</sup> (24 ... 12 AWG)  
Observe the tightening torque of the terminal screws. The tightening torque is 0.5 Nm to 0.6 Nm.
  - Spring terminals: 0.25 to 1.5 mm<sup>2</sup> (24 ... 12 AWG)
- Control side:
  - Screw terminals: 0.25 to 1.5 mm<sup>2</sup> (24 ... 12 AWG)  
Observe the tightening torque of the terminal screws. The tightening torque is 0.5 Nm to 0.6 Nm.
  - Spring terminals: 0.25 to 1.5 mm<sup>2</sup> (24 ... 12 AWG)
  - Control-system specific connector: Sub-D connector

#### Fire Protection Class

- Housing: V2 according to UL 94 standard. Unless stated otherwise all details relate to the reference conditions.

### Labeling

#### Isolated Barriers

- Space for labeling on the front side, labels: 35 mm x 10.5 mm

#### Termination Boards

- The HiALC-HiCT\*-SET-\*\*\* label carrier is available as an option for the termination boards.



---

#### Note

See corresponding datasheets for further information.

---

## 7.2 Model Number Description

### Model Number Description Isolated Barriers

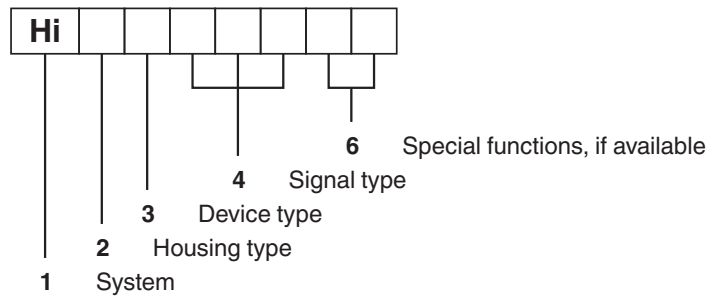

<b>Position 1</b>	Hi	H-System
<b>Position 2</b>	C	HiC device, 12.5 mm width
	D	HiD device, 18 mm width
<b>Position 3</b>	2	Isolated barrier
	5	Signal conditioner
<b>Position 4</b>	0	Analog device
	010 bis 020	Converter
	020 bis 030	Transmitter power supply
	031 bis 040	Current driver
	060 bis 090	Temperature converter
	065 und 068	Repeater
	091 bis 099	Repeater
	4	Universal device
	422	Transmitter power supply/current driver
	441	Universal barrier
	7	HART multiplexer device
	700	HART multiplexer main device
	8	Digital device
	820 bis 860	Switch amplifier
	861 bis 870	Relay module
871 bis 890	Solenoid driver	
891 bis 899	Converter	
9	Terminal module	
900	Terminal module	
<b>Position 5</b>	A	Version with other explosion protection characteristic values
	DE	Version supports the Honeywell DE SMART protocol
	ES	Version with enhanced safety
	HC	Versions for long field wiring
	R*	Version with control-system specific line fault transparency (LFT)
	Y*	Version with special functions

DOCT-0950S 2024-02

**Model Number description Generic Termination Boards**

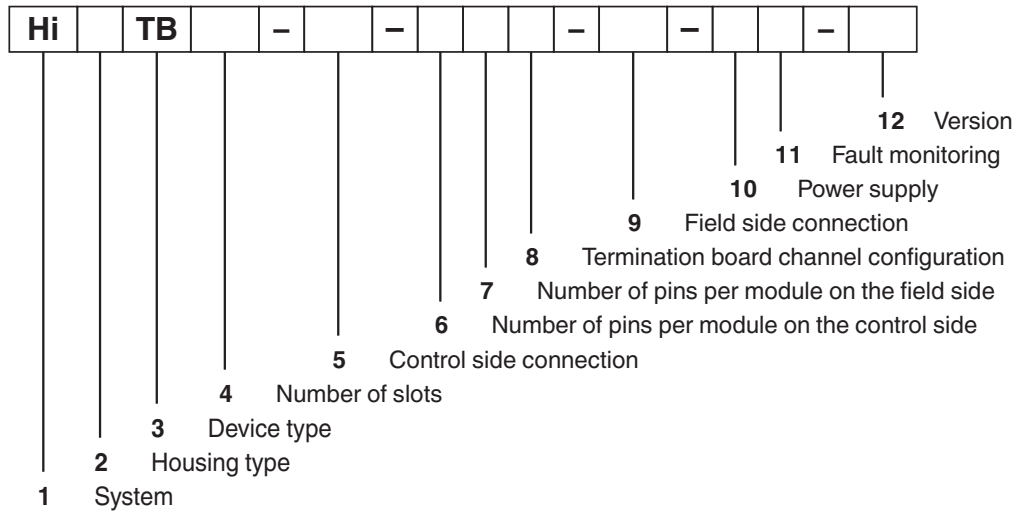

<b>Position 1</b>	Hi	H-System
<b>Position 2</b>	C	for HiC devices, housing width 12.5 mm
<b>Position 3</b>	TB	Termination board
<b>Position 4</b>	08	8 slots
	16	16 slots
	32	32 slots
<b>Position 5</b>	SCT	Screw terminals
	SDC	Sub-D connector
	SPT	Spring terminals
<b>Position 6</b>	2	2 pins per module
	4	4 pins per module
	8	8 pins per module
	9	9 pins per module
<b>Position 7</b>	2	2 pins per module
	4	4 pins per module
	8	8 pins per module
	9	9 pins per module
<b>Position 8</b>	A	Alternative channel configuration
	C	Consecutive channel configuration
	S	Channel configuration suitable for signal splitter
<b>Position 9</b>	PL	Pluggable screw terminals
	SC	Screw terminals
	SP	Spring terminals
<b>Position 10</b>	D	Daisychainable power supply
	N	Without power supply
	R	Redundant power supply
	S	Single power supply

DOCT-0950S 2024-02



<b>Position 11</b>	A	All faults monitored
	L	Capable of line fault transparency (LFT)
	M	Only module faults monitored
	S	Only supply faults monitored
<b>Position 12</b>	Y	Version
	***	Without specification



---

**Note**

See corresponding system descriptions of the control system manufacturer for further information.

---

## 7.3 Dimensions

### 7.3.1 Housing Types for H-System Isolated Barriers

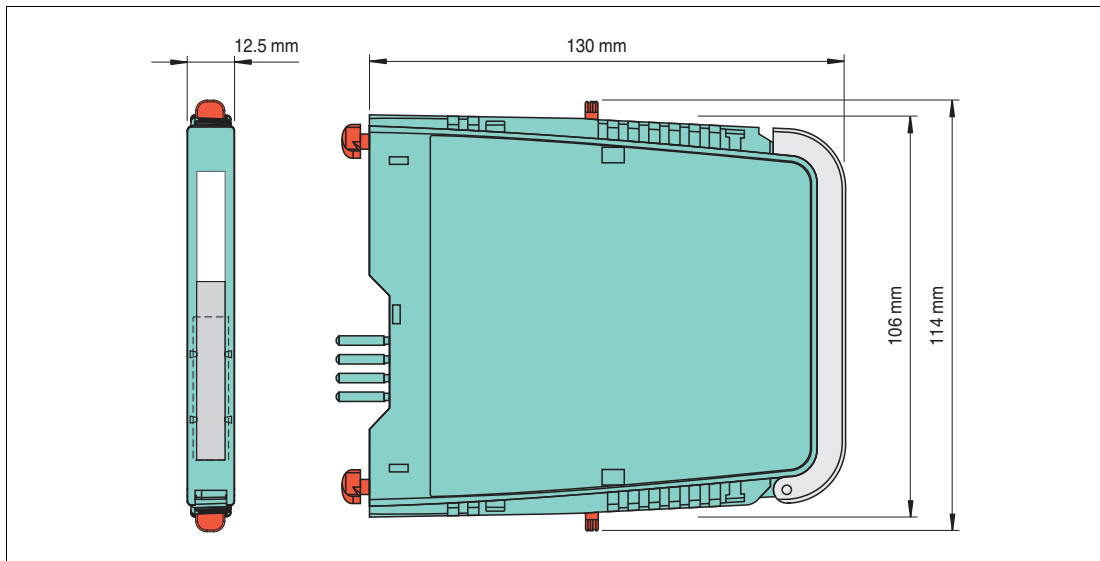

Figure 7.1 Dimensions (W x H x D): 12.5 x 114 x 130 mm (0.5 x 4.5 x 5.1 inch)

### 7.3.2 Housing Types for Termination Boards

#### Termination Board for 8 Modules

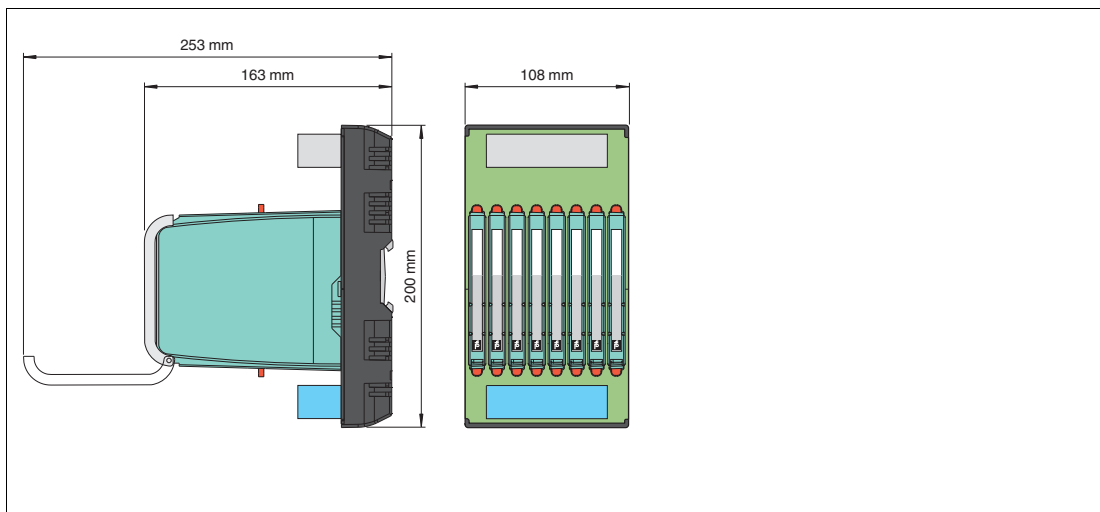

Figure 7.2 Dimensions (W x H x D): 108 x 200 x 163 mm (4.25 x 7.9 x 6.42 inch), depth including module assembly

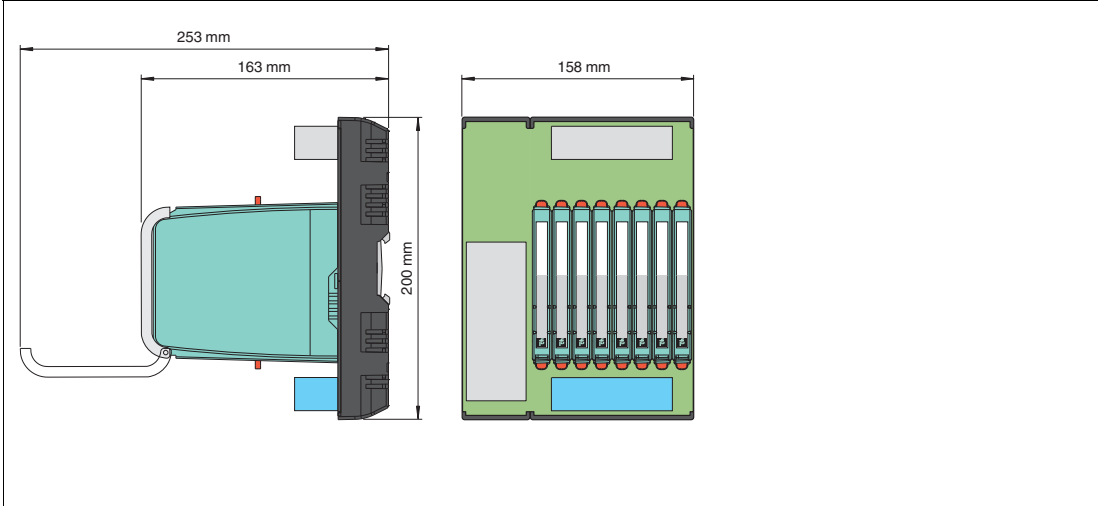

Figure 7.3 Dimensions (W x H x D): 158 x 200 x 163 mm (6.22 x 7.9 x 6.42 inch), depth including module assembly

**Termination Board for 16 Modules**

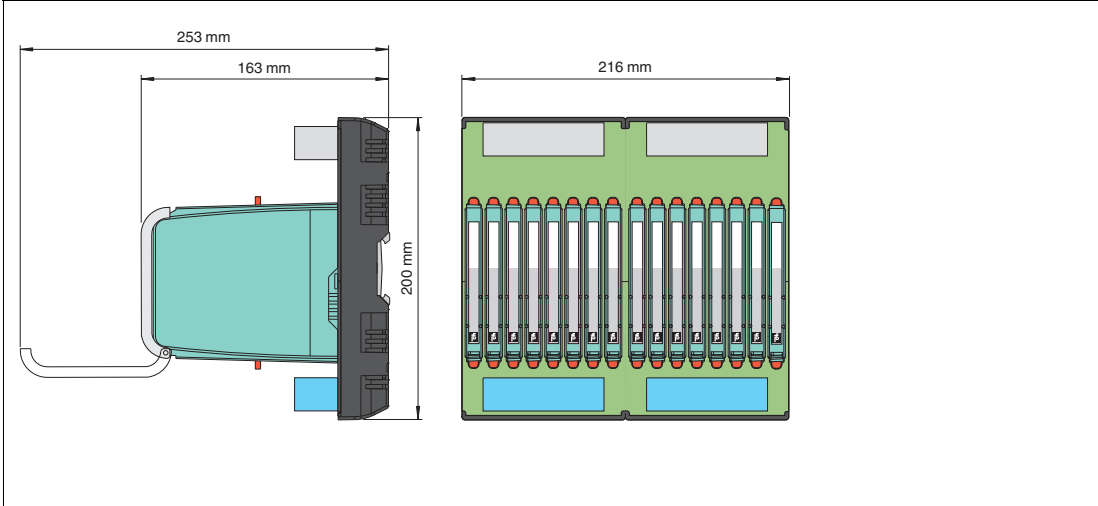

Figure 7.4 Dimensions (W x H x D): 216 x 200 x 163 mm (8.5 x 7.9 x 6.42 inch), depth including module assembly

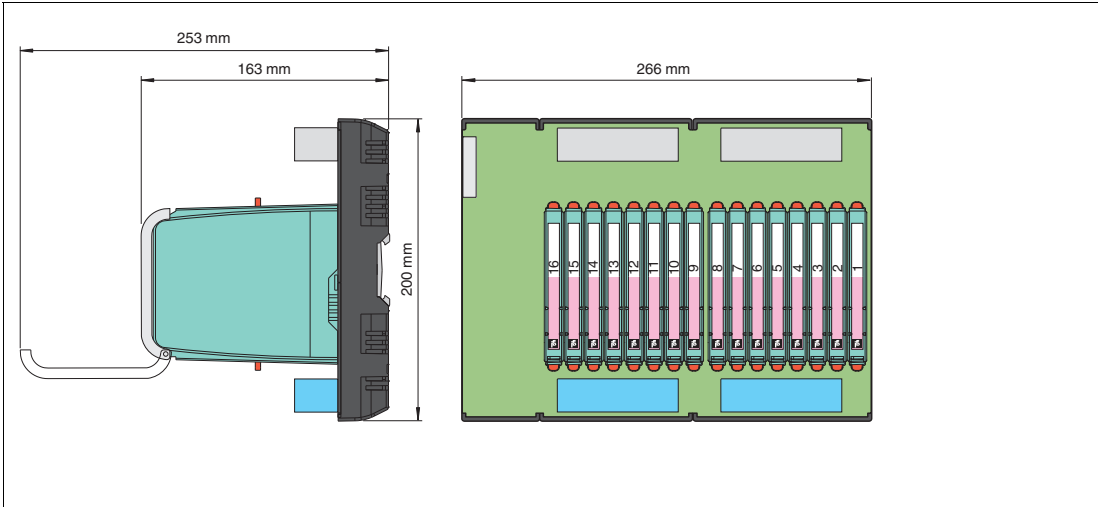

Figure 7.5 Dimensions (W x H x D): 266 x 200 x 163 mm (10.5 x 7.9 x 6.42 inch), depth including module assembly

DOCT-0950S 2024-02

### Termination Board for 32 modules

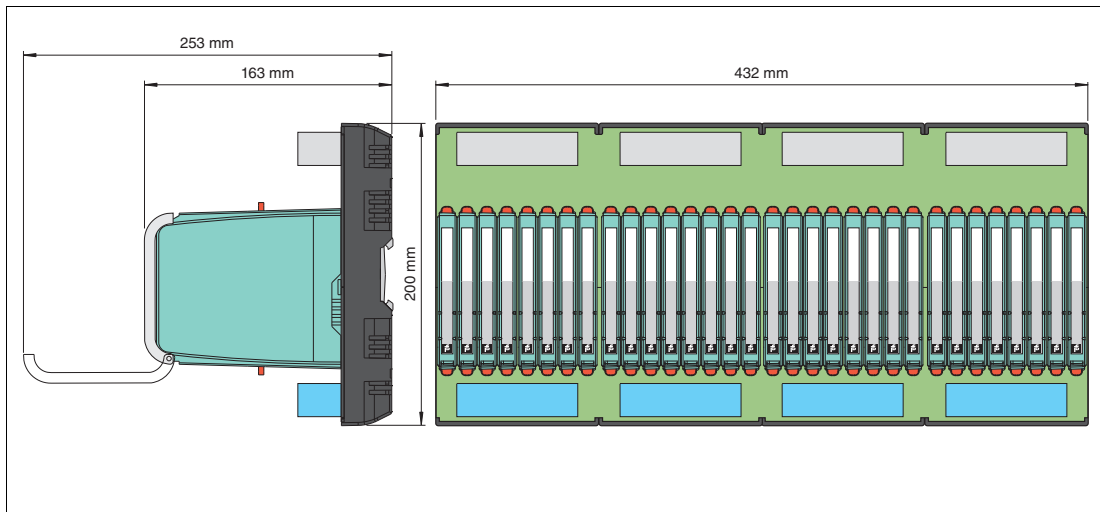

Figure 7.6 Dimensions (W x H x D): 432 x 200 x 163 mm (17 x 7.9 x 6.42 inch), depth including module assembly

### Accessory Boards

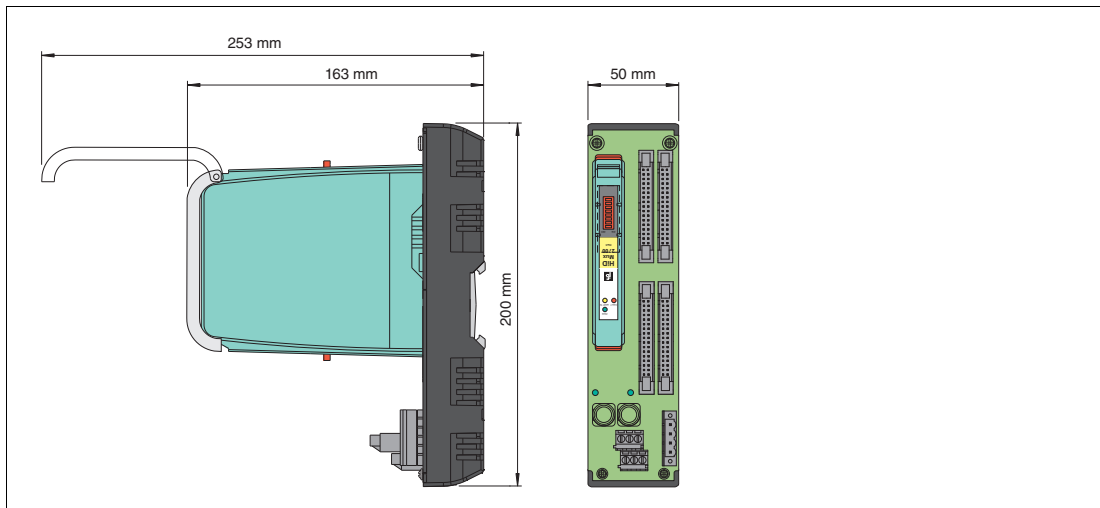

Figure 7.7 Dimensions (W x H x D): 50 x 200 x 163 mm (1.97 x 7.9 x 6.42 inch), depth including module assembly



#### Note

See corresponding system descriptions of the control system manufacturer for further information.

DOCT-0950S 2024-02

# Your automation, our passion.

## Explosion Protection

- Intrinsic Safety Barriers
- Signal Conditioners
- FieldConnex® Fieldbus
- Remote I/O Systems
- Electrical Ex Equipment
- Purge and Pressurization
- Industrial HMI
- Mobile Computing and Communications
- HART Interface Solutions
- Surge Protection
- Wireless Solutions
- Level Measurement

## Industrial Sensors

- Proximity Sensors
- Photoelectric Sensors
- Industrial Vision
- Ultrasonic Sensors
- Rotary Encoders
- Positioning Systems
- Inclination and Acceleration Sensors
- Fieldbus Modules
- AS-Interface
- Identification Systems
- Displays and Signal Processing
- Connectivity

### Pepperl+Fuchs Quality

Download our latest policy here:

[www.pepperl-fuchs.com/quality](http://www.pepperl-fuchs.com/quality)

