

MANUAL

VBG-DN-K20-D(MD)
AS-Interface/DeviceNet-Gateway





With regard to the supply of products, the current issue of the following document is applicable: The General Terms of Delivery for Products and Services of the Electrical Industry, published by the Central Association of the Electrical Industry (Zentralverband Elektrotechnik und Elektroindustrie (ZVEI) e.V.) in its most recent version as well as the supplementary clause: "Expanded reservation of proprietorship"

Table of contents

1	The Used Symbols	7
2	Safety	8
2.1	Intended use	8
2.2	General safety information	8
2.3	Waste disposal	8
3	General information	9
4	AS-i Specification 3.0	10
4.1	Accessories	10
5	Connections, Displays and Operating Keys	11
5.1	Mounting instructions	12
5.1.1	Dimensions of stainless steel gateways	12
5.1.2	Mounting	12
5.2	Single Master	13
5.2.1	Connections of the AS-i 3.0 Gateway VBG-DN-K20-D 13	
5.2.1.1	Function ground	14
5.3	Double Master	15
5.3.1	Connections of the AS-i 3.0 DeviceNet Gateway VBG-DN-K20-DMD 15	
5.3.1.1	Function ground	16
5.3.2	DeviceNet interface	17
5.4	Display and operating elements DeviceNet	18
5.4.1	LED-display DeviceNet	18
5.4.2	Push-buttons	18
6	Configuration	19
6.1	Setting DeviceNet Address and Baud Rate	19
6.2	I/O Data interpretation	19
7	First commissioning	21
7.1	Single Master VBG-DN-K20-D	21
7.1.1	Switching to advanced display mode	21
7.1.2	Setting the MAC-ID	21
7.1.3	Setting the Baud Rate	22
7.1.4	Connecting AS-i Slaves	22
7.1.5	Quick Setup	23
7.1.6	Error tracing	24
7.1.6.1	Faulty slaves	24
7.1.6.2	Error display (last error)	24
7.1.7	Addressing	25
7.1.7.1	Programming slave 2 to address 6	25

Issue date - 20.4.07

7.2	Double Master VBG-DN-K20-DMD	26
7.2.1	Switching to advanced display mode	26
7.2.2	Setting the MAC-ID	26
7.2.3	Setting the Baud Rate	27
7.2.4	Connecting AS-i Slaves	27
7.2.5	Quick Setup	28
7.2.6	Error tracing	29
7.2.6.1	Faulty slaves	29
7.2.7	Error display (last error)	29
7.2.8	Addressing	30
7.2.8.1	Programming slave 2 to address 6	30
8	Operating in Advanced Display Mode	31
8.1	DeviceNet (Fieldbus Interface)	34
8.1.1	DeviceNet MAC ID	34
8.1.2	DeviceNet Baud Rate	34
8.1.3	DeviceNet Status	35
8.1.4	DeviceNet I/O Path	35
8.2	Quick setup	35
8.2.1	Control menu (option)	36
8.2.1.1	AS-i control	36
8.2.1.2	AS-i control information	36
8.2.1.3	AS-i control run	37
8.2.1.4	AS-i control flags (flag memory control program)	37
8.3	Slave Adr Tool (slave addressing tool)	37
8.4	Slave Test Tool	38
8.5	Setup (configuration of AS-i circuit)	40
8.5.1	AS-i circuit	40
8.5.2	Description of setup mode	40
8.5.3	AS-i Slave Adr (set/change slave address)	41
8.5.4	Force offline	41
8.5.5	Operation mode	41
8.5.6	Store Act Cfg (store actual detected configuration)	42
8.5.7	Permanent Param (projected parameter)	42
8.5.8	Permanent Config (projected configuration data)	42
8.5.9	AS-i address assistant	43
8.5.10	LOS (list of offline slaves)	43
8.5.11	Auto Adr Enable (enable automatic address)	43
8.5.12	Factory reset	44
8.6	IO + Param. Test	44
8.6.1	AS-i circuit	44
8.6.2	IO + Param. Test (Testing AS-i In- and Outputs as well as reading and writing AS-i Parameters)	45
8.6.3	Binary input	45
8.6.4	Binary outputs	46
8.6.5	Analog inputs	46
8.6.6	Analog outputs	47
8.6.7	Parameter	47

8.7	Diagnosis (normal AS-i diagnosis)	48
8.7.1	AS-i circuit	48
8.7.2	Diagnosis (normal AS-i diagnosis)	48
8.7.3	Flags	49
8.7.4	Actual Config (actual configuration)	51
8.7.5	LPF (List of periphery faults)	51
8.7.6	AS-i master (info)	52
8.8	Adv. Diagnosis (advanced AS-i diagnosis)	52
8.8.1	Error counters	52
8.8.2	LCS (list of slaves having caused a configuration error)	53
8.8.3	Fault detector	53
8.9	AS-i safety	54
8.9.1	Safety slaves (safety oriented slaves)	54
8.9.2	Safety monitor	55
8.9.3	Safety Subst Value	55
8.10	Display contrast	56
8.11	Language of displayed messages	56
9	Advanced Diagnostics for AS-i Masters	57
9.1	List of corrupted AS-i Slaves (LCS)	57
9.2	Protocol analysis: counters of corrupted data telegrams	57
9.3	Offline phase on configuration errors (LOS)	58
9.4	Functions of the AS-i fault detector	58
9.4.1	Duplicate address' recognition	58
9.4.2	Earth fault detector	59
9.4.3	Noise detector	59
9.4.4	Overvoltage detector	59
10	DeviceNetEtherNet/IP Interface	60
10.1	DeviceNet Message Types	60
10.2	DeviceNet Class Services	60
10.3	Object Modelling	60
10.3.1	Identity Object	61
10.3.2	DeviceNet Object	63
10.3.3	Assembly Object	64
10.3.4	Connection Object	67
10.3.5	Parameter Object	71
10.3.6	AS-i Master Object	72
10.3.7	AS-i Slave Object	74
10.3.8	I/O Data Object	75
10.3.9	Advanced Diagnostics Object	78
10.3.10	Short Command Interface Object	78
10.3.11	Long Command Interface Object	79
11	Command Interface	80
11.1	Construction	80
11.2	List of all commands	82
11.2.1	Values for results	84

11.3	Commands of the Command Interface	84
11.3.1	AS-i 16-bit data	84
11.3.1.1	Overview of the commands	84
11.3.1.2	Read 1 16-bit Slave in.Data (RD_7X_IN)	84
11.3.1.3	Write 1 16-bit Slave out.Data (WR_7X_OUT)	85
11.3.1.4	Read 1 16-bit Slave out.Data (RD_7X_OUT)	85
11.3.1.5	Read 4 16-bit Slave in.Data (RD_7X_IN_X)	86
11.3.1.6	Write 4 7.3 Slave out.Data (WR_7X_OUT_X)	86
11.3.1.7	Read 4 7.3 Slave out.Data (RD_7X_OUT_X)	87
11.3.1.8	Read 16 channels 16-bit Slave in.Data (OP_RD_16BIT_IN_CX)	87
11.3.1.9	Write 16 channels 16-bit slave out.Data (OP_WR_16BIT_IN_CX)	88
11.3.2	Commands acc. to Profile S-7.4/S-7.5	89
11.3.2.1	Overview of the commands	89
11.3.2.2	WR_74_75_PARAM	89
11.3.2.3	RD_74_75_PARAM	90
11.3.2.4	RD_74_75_ID	91
11.3.2.5	RD_74_DIAG	91
11.3.3	Acyclic commands	92
11.3.3.1	Overview of the commands	92
11.3.3.2	WRITE_ACYCLIC_TRANS	92
11.3.3.3	READ_ACYCLIC_TRANS	94
11.3.4	AS-i Diagnosis	95
11.3.4.1	Overview of the commands	95
11.3.4.2	Get Lists and Flags (Get_LPS, Get_LAS, Get_LDS, Get_Flags) (GET_LISTS)	95
11.3.4.3	Get Flags (GET_FLAGS)	97
11.3.4.4	Get Delta List (GET_DELTA)	98
11.3.4.5	Get list of corrupted Slaves (GET_LCS and GET_LCS_R6 (6Ch))	99
11.3.4.6	Get list of activated Slaves (GET_LAS)	99
11.3.4.7	Get list of detected AS-i Slaves (GET_LDS)	100
11.3.4.8	Get list of peripheral faults (GET_LPF)	101
11.3.4.9	Get list of offline Slaves (GET_LOS)	101
11.3.4.10	Set list of offline Slaves (SET_LOS and SET_LOS_R6 (6Dh))	102
11.3.4.11	Get transm.err.counters (GET_TECA)	103
11.3.4.12	Get transm.err.counters (GET_TECB)	104
11.3.4.13	Get transm.err.counters (GET_TEC_X)	104
11.3.4.14	Read fault detector (READ_FAULT_DETECTOR)	105
11.3.4.15	Read list of duplicate addresses (READ_DUPLICATE_ADDR)	106
11.3.5	Configuration of AS-i Master	107
11.3.5.1	Overview of the commands	107
11.3.5.2	Set operation mode (SET_OP_MODE: Set_Operation_Mode)	107
11.3.5.3	Store actual configuration (STORE_CDI)	108
11.3.5.4	Read actual configuration (READ_CDI)	108
11.3.5.5	Set permanent configuration (SET_PCD)	109
11.3.5.6	Get extended permanent configuration (GET_PCD)	110
11.3.5.7	Set list of projected slaves (SET_LPS and SET_LPS_R6 (6Bh))	110
11.3.5.8	Get list of projected slaves (GET_LPS)	111
11.3.5.9	Store actual parameters (STORE_PI)	112
11.3.5.10	Write parameter (WRITE_P)	112

Issue date - 20.4.07

11.3.5.11	Read parameter (READ_PI: Read_Parameter)	113
11.3.5.12	Set permanent parameter (SET_PP)	113
11.3.5.13	Get permanent parameter (GET_PP)	114
11.3.5.14	Set auto address enable (SET_AAE)	114
11.3.5.15	Change slave address (SLAVE_ADDR)	115
11.3.5.16	Write AS-i slave extended ID1 (WRITE_XID1)	116
11.3.6	Other commands	116
11.3.6.1	Overview of the commands	116
11.3.6.2	IDLE	117
11.3.6.3	Read input data image (READ_IDI)	117
11.3.6.4	Write output data image (WRITE_ODI)	118
11.3.6.5	Read output data image (READ_ODI)	118
11.3.6.6	Set offline mode (SET_OFFLINE)	119
11.3.6.7	Release data exchange (SET_DATA_EX)	120
11.3.6.8	BUTTONS	120
11.3.6.9	FP_PARAM	120
11.3.6.10	FP_DATA	121
11.3.6.11	Inverter	122
11.3.6.12	Write Flag	122
11.3.6.13	Read Flag	123
11.3.6.14	READ_MFK_PARAM	123
11.4	Functional profiles	124
11.4.1	"Safety at Work" List 1	124
11.4.2	"Safety at Work" Monitor diagnosis	125
11.4.2.1	Setting of the AS-i diagnosis	126
11.4.2.2	Enhanced diagnosis	128
11.4.3	Integrated AS-i Sensors: Warnings	131
11.4.4	Integrated AS-i sensors: Availability	132
11.4.5	Language-select	132
11.4.6	Replacement of Safety Slaves input data	133
11.4.7	List of Safety Slaves	134
11.5	Command Interface examples	135
11.5.1	Reading 16-bit input values	135
11.5.2	Store current configuration to the AS-i master	136
11.5.3	Store new configuration for all slaves	140
12	Commissioning Tools and Accessories	148
12.1	Windows software AS-i Control Tools	148
13	Appendix: Codes indicated by the Display	151
14	Appendix: Installation instructions	153
14.1	1 Master VBG-DN-K20-D # 190324	153
14.1.1	Dimensions	153
14.1.2	Front view and connections	154
14.1.3	Startup	155
14.1.3.1	Switching to advanced display mode	155
14.1.3.2	Setting the MAC ID	155
14.1.3.3	Setting the Baud Rate	156

14.1.4	Connecting AS-i Slaves	156
14.1.5	Quick Setup	157
14.1.6	Error tracing	158
14.1.6.4	Faulty slaves	158
14.1.6.5	Error display (last error)	158
14.1.7	Addressing	159
14.1.7.6	Programming slave 2 to address 6	159
14.1.8	Montage	160
14.1.9	ZubehörAccessories	160
14.2	2 Master VBG-DN-K20-DMD # 190325	161
14.2.1	Dimensions	161
14.2.2	Front view and connections	162
14.2.3	Startup	163
14.2.3.7	Switching to advanced display mode	163
14.2.3.8	Setting the MAC ID	163
14.2.3.9	Setting the Baud Rate	164
14.2.4	Connecting AS-i Slaves	164
14.2.5	Quick Setup	165
14.2.6	Error tracing	166
14.2.6.10	Faulty slaves	166
14.2.6.11	Error display (last error)	166
14.2.7	Addressing	167
14.2.7.12	Programming slave 2 to address 6	167
14.2.8	Montage	168
14.2.9	Accessories	168
15	Appendix: integration into Rockwell PLC	169
15.1	Configuration of the AS-i DeviceNet Gateway	169
15.1.1	Adjusting the Node Address in the DeviceNet Circuit	169
15.1.2	Adjusting the DeviceNet Baudrate	170
15.1.3	Adjusting the DeviceNet I/O Path	171
15.2	Configuring the AS-i Gateway in the DeviceNet Scanner	172
15.2.1	Configuring the AS-i Gateway in the DeviceNet Scanner by using RSLink	172
15.2.2	Configuring the AS-i Gateway in the DeviceNet Scanner by using RSNetWorx	174
15.2.2.1	Configuring the EDS File	175
15.2.2.2	Configuring the Node Address and the Data Rate	178
15.2.2.3	Configuring the Scanlist	180
15.3	Configuring the I/O Path	184
16	Appendix: integration into Rockwell PLC PLC5	189
16.1	Configuration of the AS-i 3.0 DeviceNet Gateway	189
16.1.1	Adjusting the Node Address in the DeviceNet Circuit	189
16.1.2	Adjusting the DeviceNet Baudrate	190
16.2	Communication of the Gateway to the PLC	190
16.3	Configuring the AS-i Gateway in the DeviceNet Scanner	192
17	Glossary: AS-i Terms	196

1 The Used Symbols

 <p>Warning</p>	<p>This symbol warns the user of possible danger. Not following this warning can lead to personal injury or death and/or destruction of the equipment.</p>
---	--

 <p>Attention</p>	<p>This symbol warns the user of a possible failure. Not following this warning can lead to total failure of the device or any other connected equipment.</p>
---	---

 <p>Note</p>	<p>This symbol draws the user's attention to important information.</p>
--	---

2 Safety

2.1 Intended use

 <p>Warning</p>	<p>The protection of operating personnel and the system against possible danger is not guaranteed if the control interface unit is not operated in accordance with its intended use.</p> <p>The device may only be operated by appropriately qualified personnel in accordance with this operating manual.</p>
--	--

2.2 General safety information

 <p>Warning</p>	<p>Safety and correct functioning of the device cannot be guaranteed if any operation other than that described in this operation manual is performed.</p> <p>Connecting the equipment and any maintenance work to be carried out with voltage applied to the equipment must exclusively be performed by appropriately qualified electrotechnical personnel.</p> <p>In case a failure cannot be repaired, the device must be taken out of operation and kept from inadvertently being put back into operation.</p> <p>Repair work is to be carried out by the manufacturer only. Additions or modifications to the equipment are not allowed and will void the warranty.</p>
--	--

 <p>Note</p>	<p>The operator is responsible for the observance of local safety standards.</p>
--	--

2.3 Waste disposal

 <p>Attention</p>	<ul style="list-style-type: none"> • All devices and components are to be used properly! • Non-usable electrical components are hazardous waste and they should be disposed separately! • Local and national guide lines during waste disposal are to be respected!
--	--

3 General information

This operating instruction holds for the following devices of the Pepperl+Fuchs Group:

VBG-DN-K20-D # 190324	AS-i 3.0 DeviceNet-Gateway in Stainless Steel, single master
VBG-DN-K20-DMD # 190325	AS-i 3.0 DeviceNet-Gateway in Stainless Steel, double master

The AS-i/DeviceNet-Gateway serves to connect the AS-i to a superordinate DeviceNet. The Gateway acts as a complete Master for the AS-i and as a slave for the DeviceNet.

4 AS-i Specification 3.0

The AS-i 3.0 DeviceNet Gateways already fulfil the new AS-i Specification 3.0. The previous specifications (2.1 and 2.0) are supported as well.

Advanced diagnostics

Diagnostics, which go far beyond the standard diagnostics facilitate the simple detection of the occasionally occurring configuration errors and further irritations towards the AS-i communication. So in case of an error the down time of machines can be minimized or you can initiate preventive maintenance.

Commissioning and monitoring

The AS-i 3.0 DeviceNet Gateways can be commissioned with the help of the software "AS-i Control Tools" in combination with the DeviceNet Master Simulator. The EDS file is included in the package.

Commissioning, debugging and setting up of the AS-i parameters without the software can also be accomplished with the use of push-buttons, the display and the LEDs directly on the system.

4.1 Accessories

- PC-Software „AS-i-Control-Tools“ with serial transmission cable for connection of the AS-i Master in Stainless Steel
- DeviceNet Mastersimulator
- Data transmission cable for AS-i Gateways with CAN-Interface

5 Connections, Displays and Operating Keys

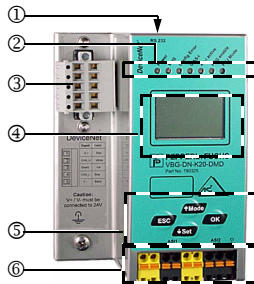

On the front panel of the device in stainless steel housing are located:

- [1] RS 232 diagnostic interface (only in connection with "AS-i Control Tools")
- [2] LEDs
- [3] DeviceNet (5-pin plug) connector as DeviceNet interface
- [4] LC display
- [5] Push-buttons to configure the device
- [6] Terminals to connect the power supply and the AS-i circuit.

5.1 Mounting instructions

5.1.1 Dimensions of stainless steel gateways

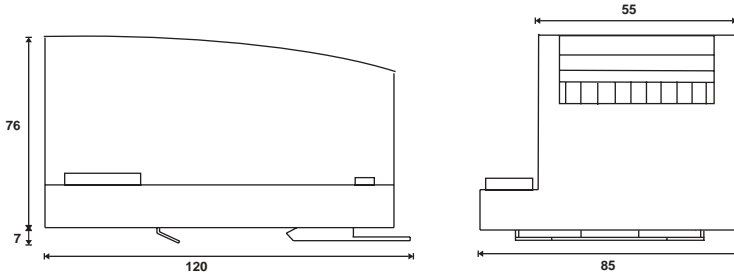

5.1.2 Mounting

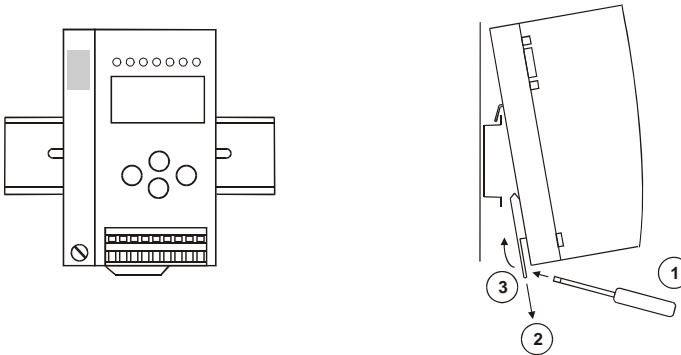

For the mounting of the gateways in stainless steel are mounting plates with 35 mm top-hat rail intended.



Note

Please view the pertinent assembly instruction in *chapter 14* for further details.

5.2 Single Master

5.2.1 Connections of the AS-i 3.0 Gateway VBG-DN-K20-D

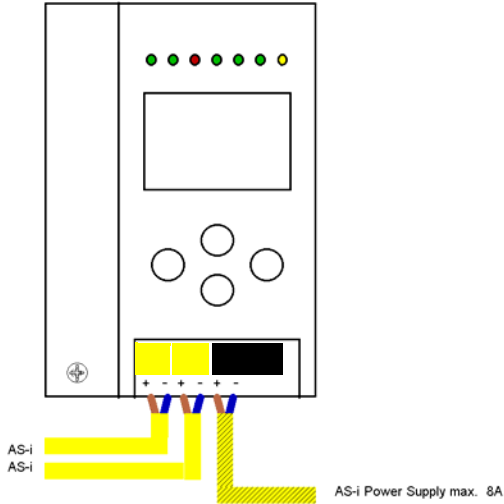

Note

It is not allowed to connect AS-i power supplies or another master to the yellow marked cable.



Note

It is not allowed to connect slaves or repeaters to the hatched marked cable.

5.2.1.1 Function ground

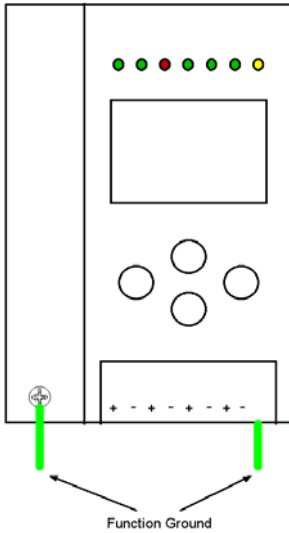



- The function ground can be connected either at the ground screw or at the terminal.
- The function ground should be connected with a cable as short as possible to guarantee a good EMC property.
- Therefore it is preferred to connect the ground via the ground screw.

5.3 Double Master

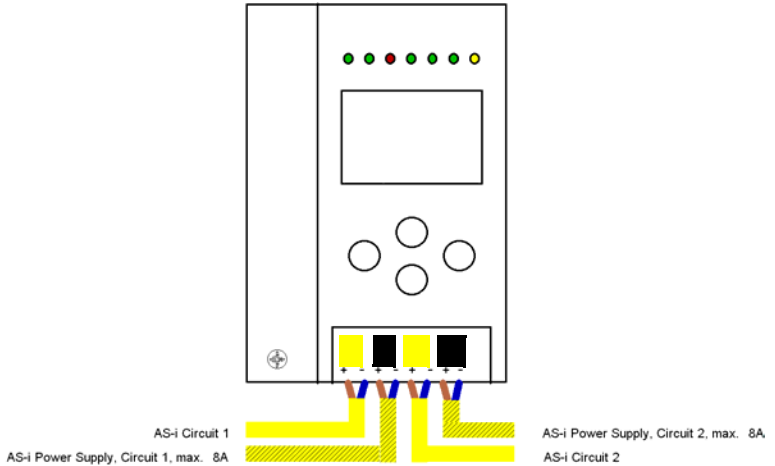
5.3.1 Connections of the AS-i 3.0 DeviceNet Gateway VBG-DN-K20-DMD



 Note	AS-i circuit 1 and 2 are powered by separate power supplies.
 Note	It is not allowed to connect slaves or repeaters to the hatched marked cable.
 Note	It is not allowed to connect AS-i power supplies or another master to the yellow marked cable.

5.3.1.1 Function ground

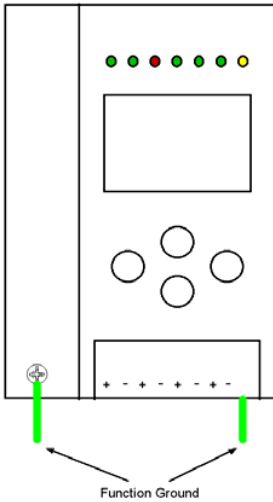

Note

- The function ground can be connected either at the ground screw or at the terminal.
- The function ground should be connected with a cable as short as possible to guarantee a good EMC property.
- Therefore it is preferred to connect the ground via the ground screw.

5.3.2 DeviceNet interface

The DeviceNet interface connector is designed as a 5-pin COMBICON connector. It is located on the left hand side of the front panel (see chapter 5).

	Signal	Color
1	V+	red
2	CAN_H	white
3	Shield	n/a
4	CAN_L	blue
5	V -	black

5.4 Display and operating elements DeviceNet

5.4.1 LED-display DeviceNet

There are seven light-emitting diodes on the front panel of the gateway . They have the following function:

- | | |
|--------------------|---|
| Power | The master's power supply is sufficient. |
| Ser. active | <p>Modul-/Network-Status-LED (MNS)</p> <p>red LED flashes: no CAN communication in "Pre Operational Mode"</p> <p>green LED flashes: CAN communication node in "Pre Operational Mode"</p> <p>green LED:CAN communication node in "Operational Mode"</p> |
| Config err | <p>Configuration error:</p> <p>At least one configured slave is missing, at least one detected slave is not projected or for at least one projected and detected slave the actual configuration data does not match the nominal configuration data.</p> <p>This LED flashes if there is at least one periphery fault at one AS-i slave in the AS-i network. If there are configuration errors as well as periphery faults, only configuration error is displayed.</p> |
| U AS-i | The AS-i circuit is sufficiently powered. |
| AS-i active | Normal operation active (Flashes, if a B-slave is displayed). |
| prg enable | <p>Automatic address programming enabled.</p> <p>Exactly one slave is missing in protected operating mode. The slave can be replaced by another slave of the same type with address zero. The master addresses the new slave to the faulty address and thus eliminates the configuration error.</p> |
| prj mode | The AS-i master is in configuration mode. |

5.4.2 Push-buttons

The push-buttons cause the following:

- | | |
|----------|---|
| Mode/↑↑> | Switching between configuration mode and protected operating mode and saving the current AS-i configuration as the nominal configuration. |
| Set/↓↓ | Selecting and assigning the address to a slave. |
| OK, ESC | Changing to the advanced display mode. |

6 Configuration

6.1 Setting DeviceNet Address and Baud Rate

To set the DeviceNet address and baud rate, refer to the front panel of the gateway. Locate the two buttons on the front panel marked "mode" and "set". By pressing both buttons simultaneously for approximately 5 seconds, the actual DeviceNet address will appear on the LCD display. DeviceNet address can be changed by pressing the "set" button until the desired DeviceNet address has been reached. To store the DeviceNet address, press the "mode" button. Now the LCD screen displays a 0, 1, or 2. See the chart below for the meaning of the code.

CODE	BAUD RATE
0	125k Baud
1	250k Baud
2	500k Baud

Press the "set" button until the desired code is reached. Again press the "mode" button to store the baud rate. The setting of the DeviceNet address and baud rate is complete.

The default address is 63 and the default baud rate is 125 kBaud.

6.2 I/O Data interpretation

Input data comes from Assembly Object Instance 100 (single channel) or 118 (double channel).

Output data comes from Assembly Object Instance 118 (single channel) or 154 (double channel).

These bytes of data are as follows:

byte	2 ⁷	2 ⁶	2 ⁵	2 ⁴	2 ³	2 ²	2 ¹	2 ⁰
0	flags				slave 1/1A			
	F3	F2	F1	F0	D3	D2	D1	D0
1	slave 2/2A				slave 3/3A			
2	slave 4/4A				slave 5/5A			
3	slave 6/6A				slave 7/7A			
4	slave 8/8A				slave 9/9A			
5	slave 10/10A				slave 11/11A			
6	slave 12/12A				slave 13/13A			
7	slave 14/14A				slave 15/15A			
8	slave 16/16A				slave 17/17A			
9	slave 18/18A				slave 19/19A			
10	slave 20/20A				slave 21/21A			
11	slave 22/22A				slave 23/23A			
12	slave 24/24A				slave 25/25A			
13	slave 26/26A				slave 27/27A			

byte	2 ⁷	2 ⁶	2 ⁵	2 ⁴	2 ³	2 ²	2 ¹	2 ⁰
14	slave 28/28A				slave 29/29A			
15	slave 30/30A				slave 31/31A			
16	reserved				slave 1B			
17	slave 2B				slave 3B			
18	slave 4B				slave 5B			
19	slave 6B				slave 7B			
20	slave 8B				slave 9B			
21	slave 10B				slave 11B			
22	slave 12B				slave 13B			
23	slave 14B				slave 15B			
24	slave 16B				slave 17B			
25	slave 18B				slave 19B			
26	slave 20B				slave 21B			
27	slave 22B				slave 23B			
28	slave 24B				slave 25B			
29	slave 26B				slave 27B			
30	slave 28B				slave 29B			
31	slave 30B				slave 31B			

Flags		
	input data	output data
F0	ConfigError	Off-line
F1	APF	LOS-master-bit
F2	PeripheryFault	→ ConfigurationMode
F3	ConfigurationActive	→ ProtectedMode

ConfigError: 0 = ConfigOK, 1 = ConfigError
 APF: 0 = AS-i-Power OK, 1 = AS-i-Power Fail
 PeripheryFault: 0 = PeripheryOK, 1 = PeripheryFault
 ConfigurationActive: 0 = ConfigurationActive, 1 = ConfigurationInactive
 Off-Line: 0 = OnLine, 1 = Off-Line
 LOS-master-bit 0 = Off-Line by ConfigError deactivated
 1 = Off-Line by ConfigError activated

A rising edge of the "LOS master bit" effects that all bits in the LOS are set. A falling edge effects that all bits are reset.

7 First commissioning

7.1 Single Master VBG-DN-K20-D

7.1.1 Switching to advanced display mode

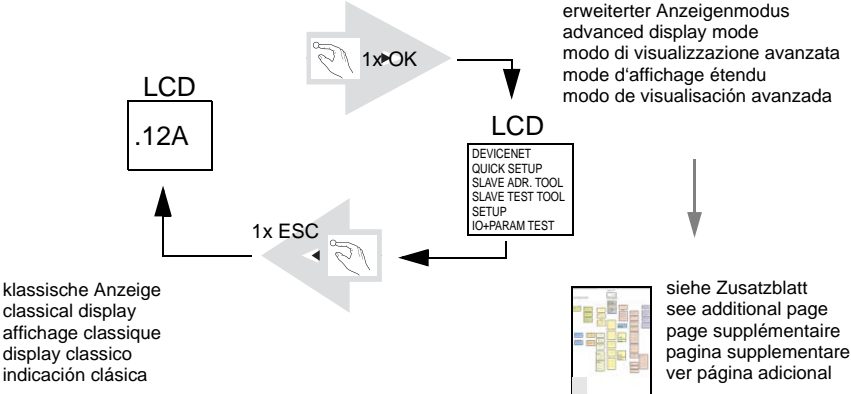

7.1.2 Setting the MAC-ID

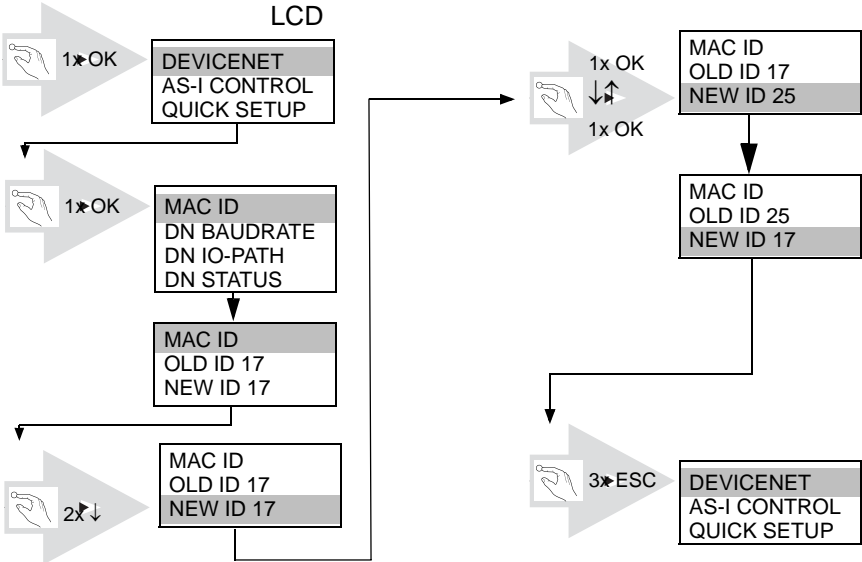

Issue date - 20.4.2007

7.1.3 Setting the Baud Rate

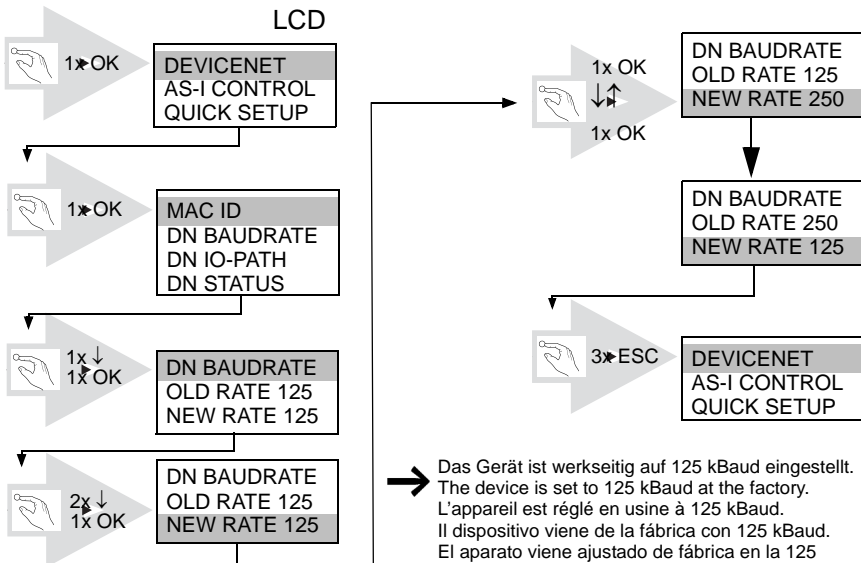

7.1.4 Connecting AS-i Slaves

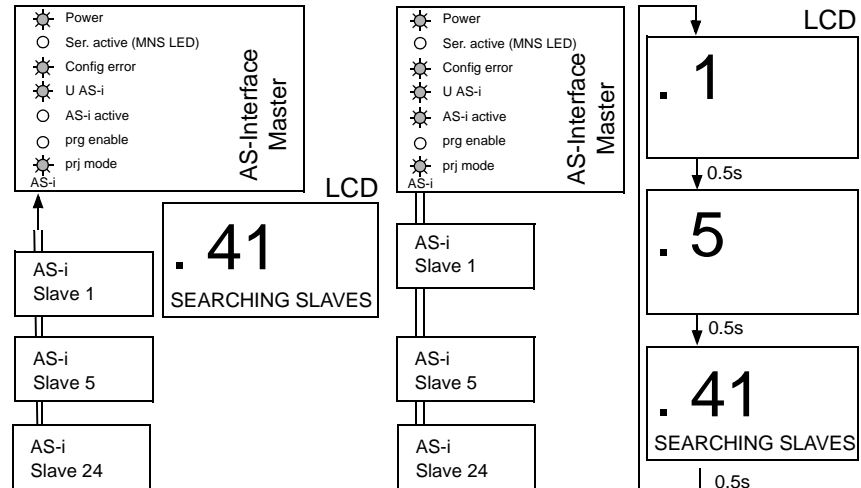

Note Please view the chapter 5.4.1 to find the description of all LEDs.

Issue date: 20.4.2007

7.1.5 Quick Setup

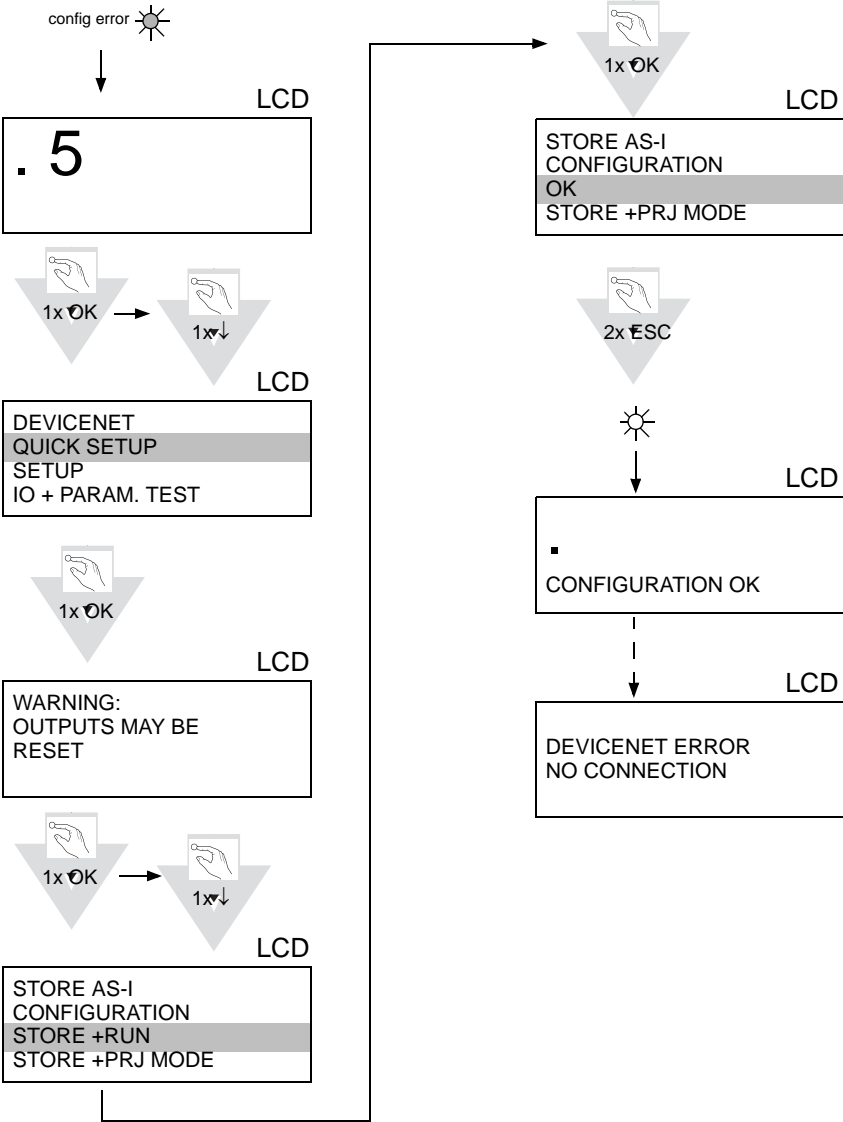

Issue date - 20.4.2007

7.1.6 Error tracing

7.1.6.1 Faulty slaves

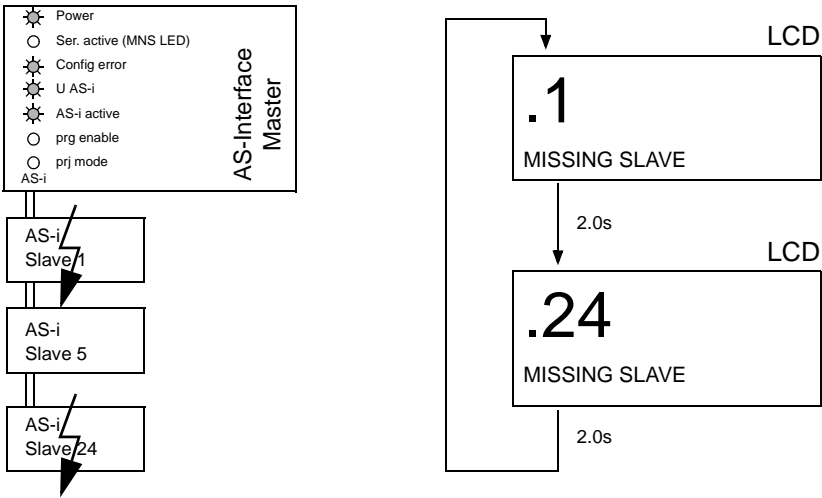

7.1.6.2 Error display (last error)

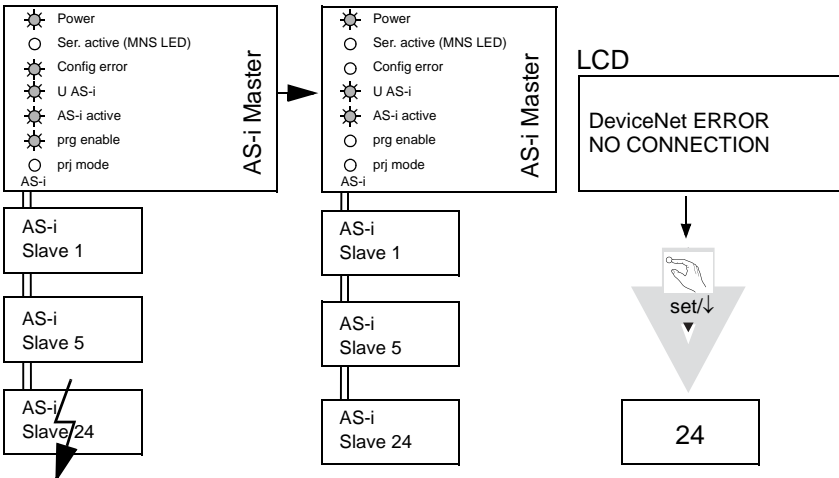

Note

Please view the chapter 5.4.1 to find the description of all LEDs.

Issue date - 20.4.2007

7.1.7 Addressing

7.1.7.1 Programming slave 2 to address 6

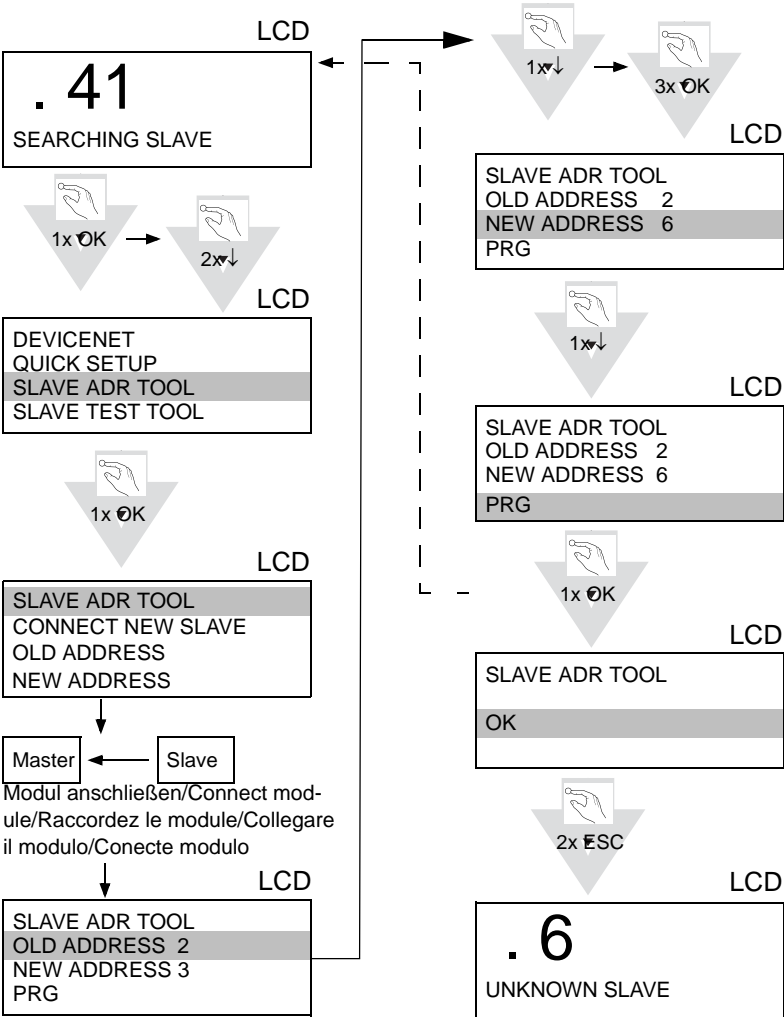

7.2 Double Master VBG-DN-K20-DMD

7.2.1 Switching to advanced display mode

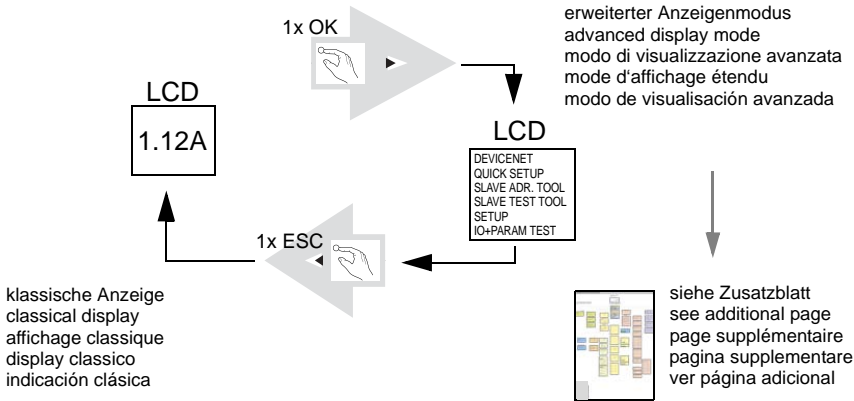

7.2.2 Setting the MAC-ID

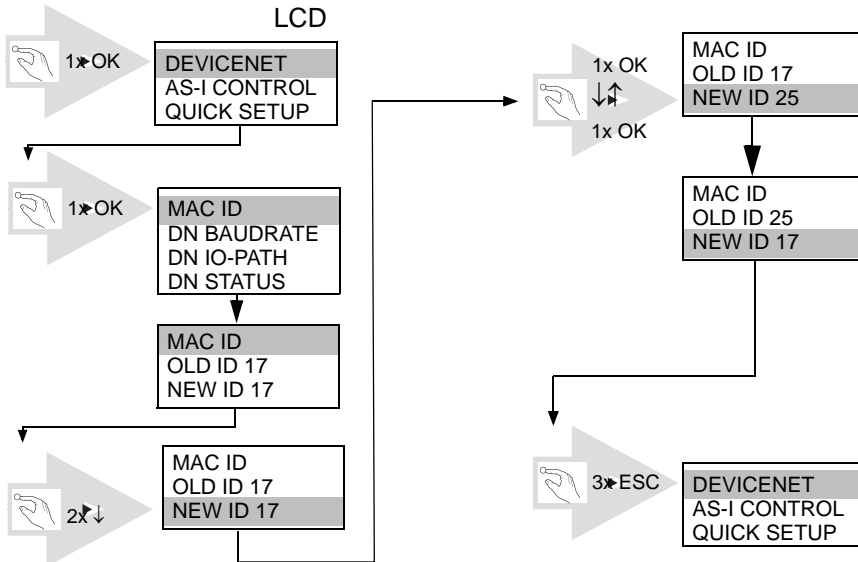

7.2.3 Setting the Baud Rate

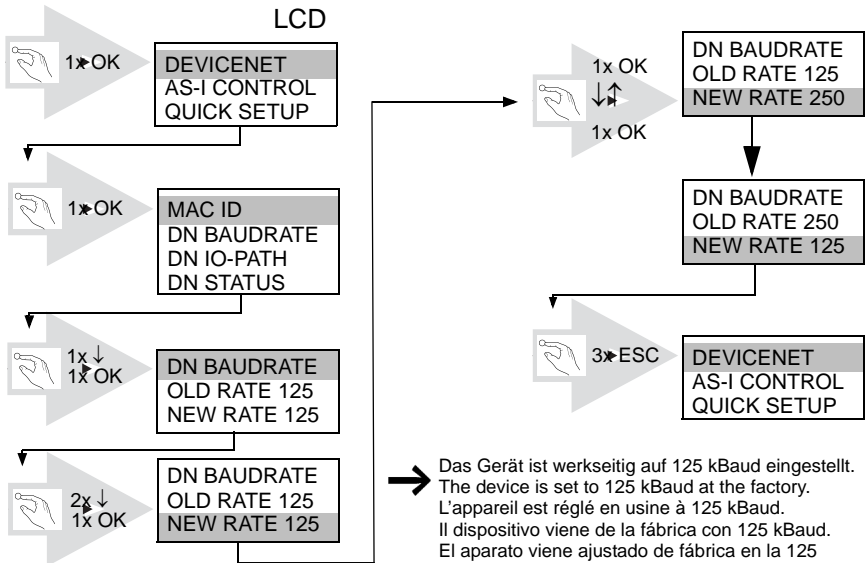

7.2.4 Connecting AS-i Slaves

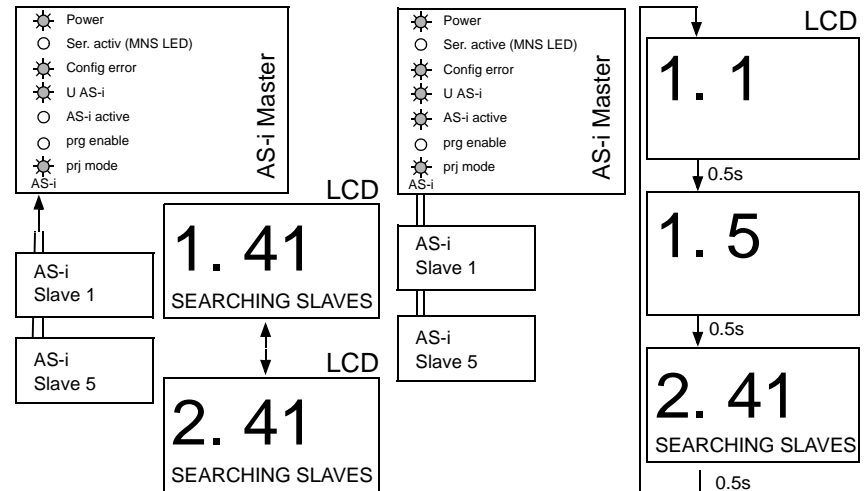

Please view the chapter 5.4.1 to find the description of all LEDs.

7.2.5 Quick Setup

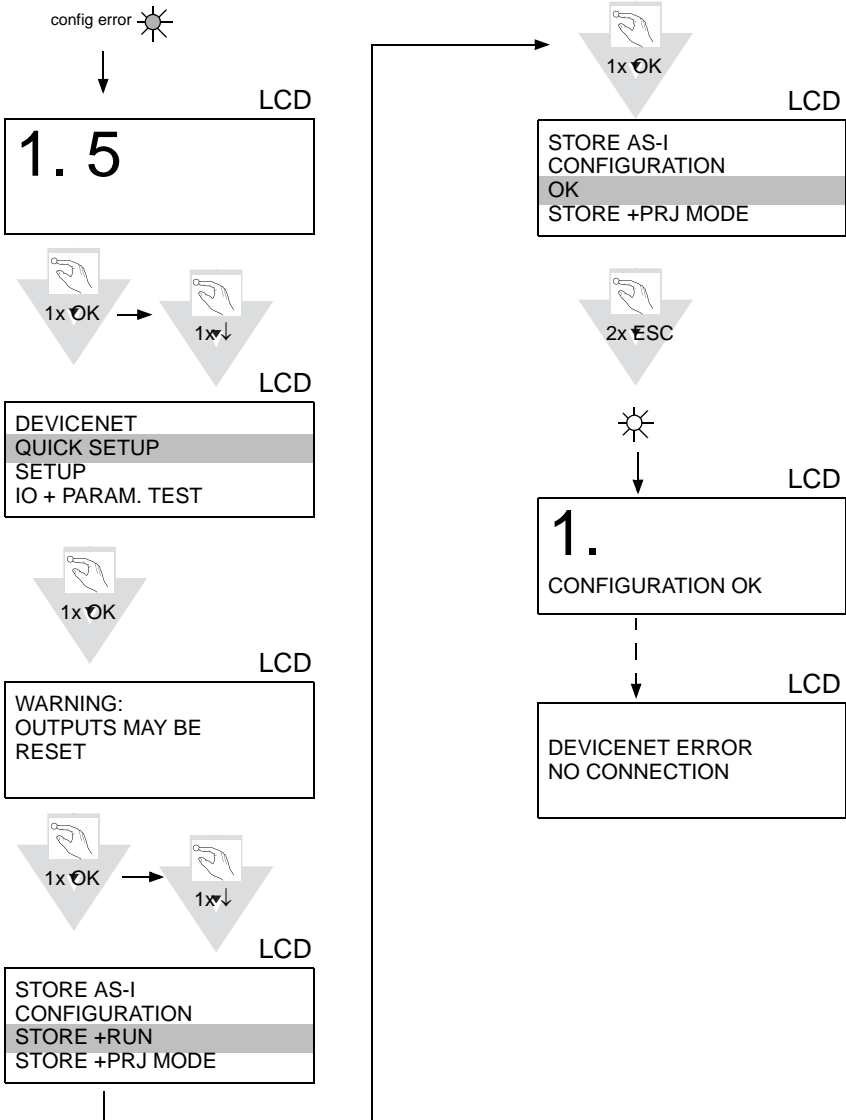

Issue date - 20.4.2007

7.2.6 Error tracing

7.2.6.1 Faulty slaves



7.2.7 Error display (last error)

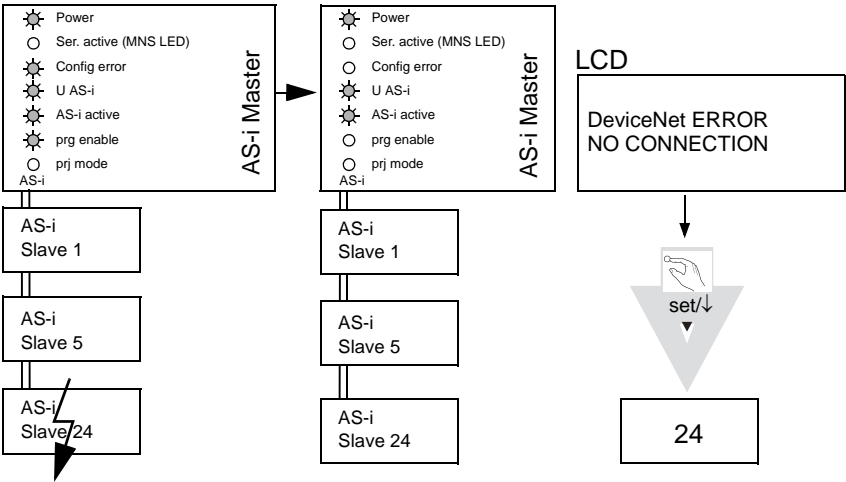

Issue date - 20.4.2007

Note Please view the chapter 5.4.1 to find the description of all LEDs.

7.2.8 Addressing

7.2.8.1 Programming slave 2 to address 6

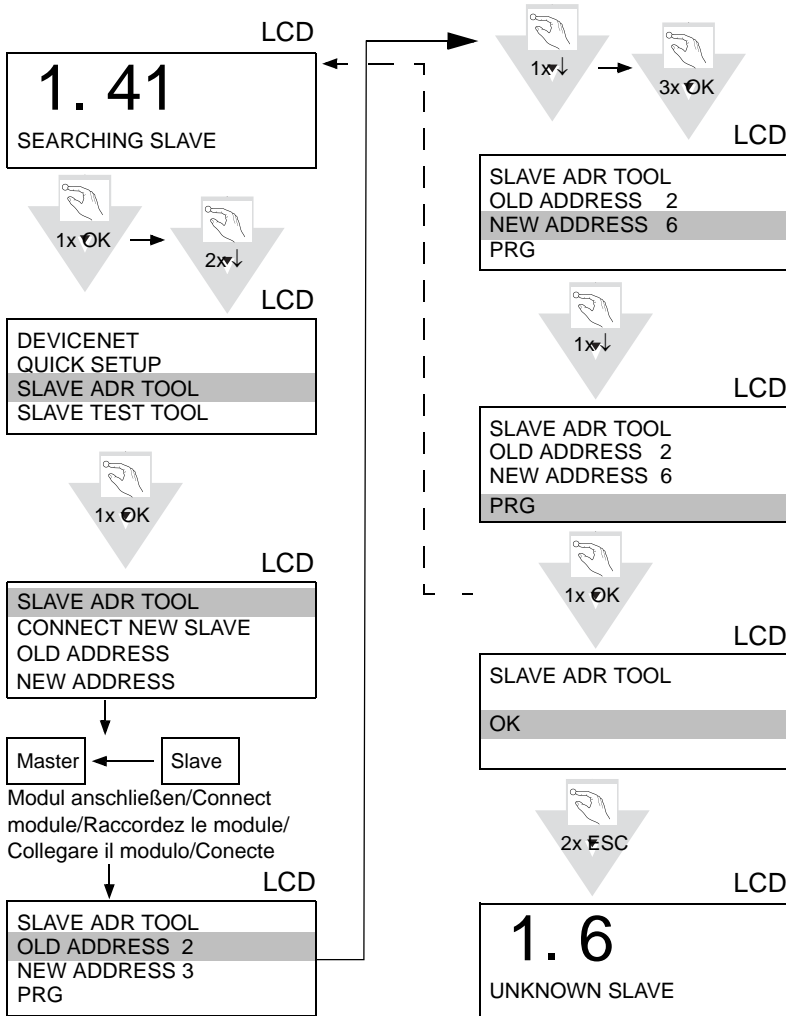

8 Operating in Advanced Display Mode

AS-i 3.0 DeviceNet-Gateway: Inbetriebnahme/Commissioning

Klassischer Modus / Classic Mode

1.12A

grün markierte Werte sind editierbar
green marked data can be edited

Erweiterter Display Modus / Advanced Display Mode

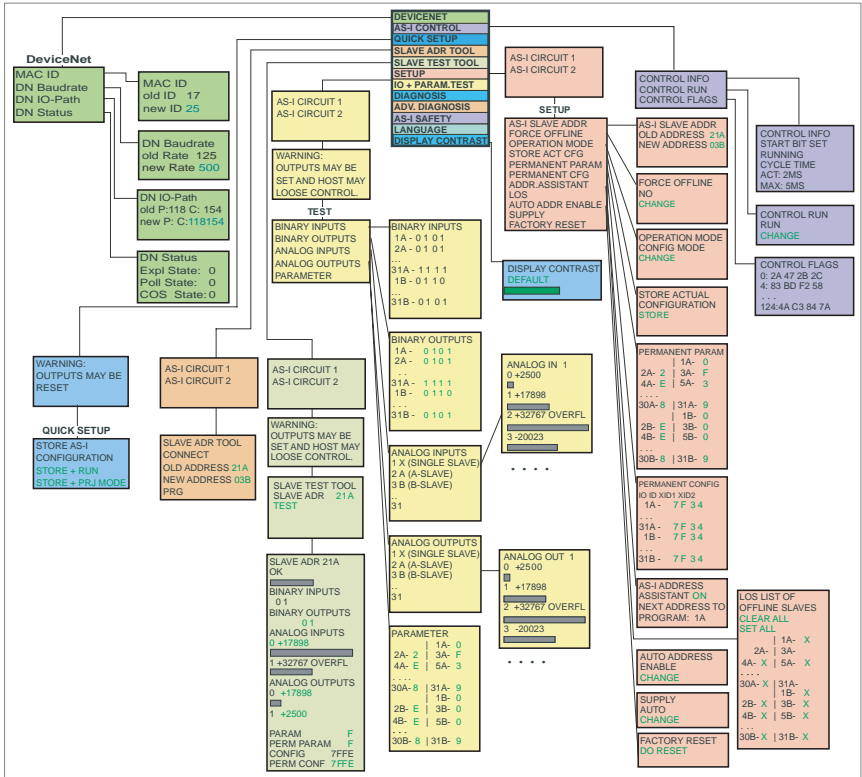

Grundsätzliche Bedienung
Das Gerät startet im traditionellen Modus. Mit ESC oder OK kann zwischen beiden Modi gewechselt werden. Im Erweiterten Modus wird ein Cursor mit den beiden Pfeil-Tasten bewegt. OK bringt ins nächsthöhere Menü (in der Zeichnung weiter nach rechts). ESC bringt zurück ins vorherige Menü. Wenn Werte editiert werden, werden sie zunächst mit dem Cursor markiert, dann mit OK ausgewählt, mit den Pfeiltasten verändert und schließlich mit OK übernommen. ESC bricht das Editieren ab.

Basic Operation
The device starts in the traditional mode. You can switch between the two modes with ESC or OK. In the advanced mode the cursor is moved by both arrow buttons. Pushing OK puts you to the superior menu (in the drawing one step to the right side). ESC puts you back to the previous menu. To edit data you first mark them with the cursor and then select them with OK, change them with the arrow buttons and finally apply them with OK. Pushing ESC cancels the editing.

Issue date - 20.4.2007

AS-Interface Operating in Advanced Display Mode

AS-i 3.0 DeviceNet-Gateway: Inbetriebnahme/Commissioning

Klassischer Modus / Classic Mode

1.12A

grün markierte Werte sind editierbar
green marked data can be edited

Erweiterter Display Modus / Advanced Display Mode

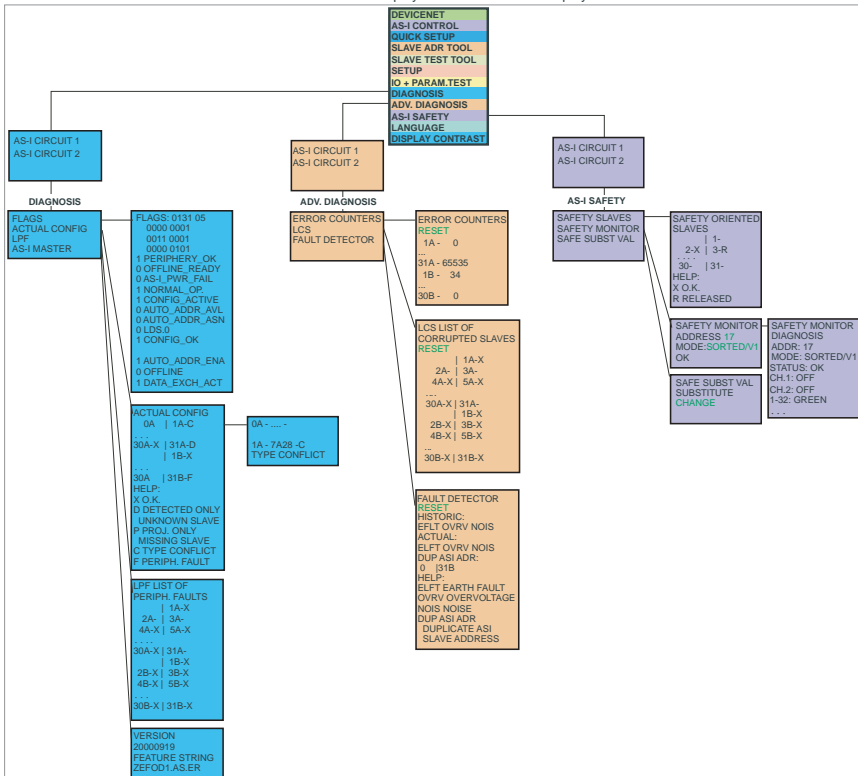

Grundsätzliche Bedienung

Das Gerät startet im traditionellen Modus. Mit ESC oder OK kann zwischen beiden Modi gewechselt werden. Im Erweiterten Modus wird ein Cursor mit den beiden Pfeil-Tasten bewegt. OK bringt ins nächsthöhere Menü (in der Zeichnung weiter nach rechts). ESC bringt zurück ins vorherige Menü. Wenn Werte editiert werden, werden sie zunächst mit dem Cursor markiert, dann mit OK ausgewählt, mit den Pfeiltasten verändert und schließlich mit OK übernommen. ESC bricht das Editieren ab.

Basic Operation

The device starts in the traditional mode. You can switch between the two modes with ESC or OK. In the advanced mode the cursor is moved by both arrow buttons. Pushing OK puts you to the superior menu (in the drawing one step to the right side). ESC puts you back to the previous menu. To edit data you first mark them with the cursor and then select them with OK, change them with the arrow buttons and finally apply them with OK. Pushing ESC cancels the editing.

Issue date - 20.4.2007



In the classical mode, it is possible to change settings while the device is in operation. This can lead to failure of the plant (e. g. changing the address of an AS-i slave).

In the advanced mode, however, the settings are protected, as long as the superior fieldbus is running.

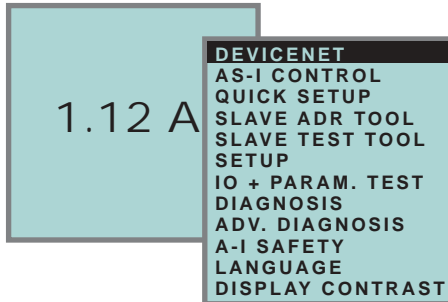

The device starts in the classical mode (see chapter 8). Press ESC to switch to the extended mode.

In the extended mode, the selection can be moved up and down with the arrow buttons.

Pressing OK will switch to the selected function or menu. Pressing ESC will switch back to the previous menu.

To edit data values highlight them with the selection bar, press OK, then change them with the arrow-buttons and confirm with OK. The ESC-button cancels the editing process.

All possible addresses are displayed one after the other from 1A to 31A and from 1B to 31B. Data for single slaves are displayed at the addresses 1A - 31A.

8.1 DeviceNet (Fieldbus Interface)

```
MAC ID
DN BAUDRATE
DN IO-PATH
DN STATUS
```

8.1.1 DeviceNet MAC ID

```
MAC ID
OLD ID 17
NEW ID 25
```

This function is used for the setting and changing of the DeviceNet address.

The number behind "ID" shows the actual station address. By selecting "New ID", this ID can be changed.

8.1.2 DeviceNet Baud Rate

```
DN BAUDRATE
OLD RATE 125
NEW RATE 500
```

This function is used for setting and changing the DeviceNet Baud Rate.

The number behind "Old Rate" shows the actual baud rate. By selecting "New Rate" you can change this Baud Rate.

Following baud rates can be adjusted:

- 10 kBaud
- 20 kBaud
- 50 kBaud
- 100 kBaud
- 125 kBaud
- 250 kBaud
- 500 kBaud
- 800 kBaud
- 1000 kBaud

On delivery, the Baud Rate is set to 125 kBaud.

8.1.3 DeviceNet Status

```
DN STATUS
EXPL STATE: 0
POLL STATE: 0
COS STATE: 0
```

The function DeviceNet status indicates if and how many connections are active on each DeviceNet channel. Following status are indicated:

- 0 = nonexistent
- 1 = configuring
- 2 = waiting of connection ID
- 3 = established
- 4 = timed out
- 5 = deferred delete

8.1.4 DeviceNet I/O Path

```
DN IO-PATH
OLD P: 118 C: 154
NEW P: C: 118154
```

With this function the DeviceNet POLL Connection Production/Consume Path and the Cyclic/COS Production Path can be easily modified. The displayed values are the assembly instances of the Production and Consume Path. If the current path values are inconsistent for this function the old values are marked with "---".

"P" modifies the Production Path of the POLL and the Cyclic/COS connection. "C" the Consume Path of the POLL Connection.

8.2 Quick setup

This menu enables a fast configuration of the AS-i network.

```
WARNING:
OUTPUT MAY BE
RESET
```



Warning: outputs may be reset!

Pressing "OK" you switch to the submenu "Store AS-i Configuration".

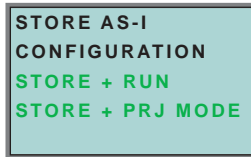

"Store+Run"

With "OK" you store the current AS-i network configuration and the attached slaves as the target configuration. The gateway changes into the protected operating mode.

"Store+Prj Mode"

With "OK" you store the current AS-i network configuration and the attached slaves. The gateway remains in the *project mode*.

By pressing the "ESC" button you leave this menu and switch back to the main menu.

8.2.1 Control menu (option)

8.2.1.1 AS-i control

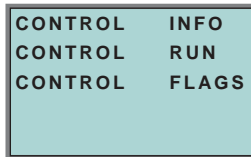

8.2.1.2 AS-i control information

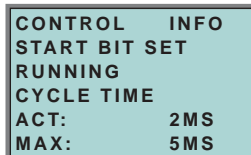

This function displays the current status of the AS-control (control program).

START BIT SET: the control program was started.

START BIT RESET: the control program was stopped.

RUNNING: the control program is running.

STOPPED: the control program was stopped.

The control program can be stopped even though the start bit was set. Example: any configuration error occurs, or the master is in the configuration mode.

CYCLE TIME ACT: current cycle time of the control program.

CYCLE TIME MAX: maximal cycle time of the control program since its last start.

8.2.1.3 AS-i control run

```
CONTROL RUN
RUN
CHANGE
```

CONTROL RUN: the control program can be stopped with this function. It modifies the start bit in the menu Control Info.

RUN: the control program has been started. Even if the start bit is set, the control program can be stopped; example: any configuration error occurs, or the master is in the configuration mode.

CHANGE: the configuration program is stopped.

8.2.1.4 AS-i control flags (flag memory control program)

```
CONTROL FLAGS
0:2A 47 2B 2C
4:83 BD F2 58
...
124: 4A C3 84 7A
```

The control program can read and modify the flag memory with the function "AS-i Control flags".

A procedure of modifying flag memory:

- select a line with soft keys
- press *OK* to open the selected menu

```
5:10111101
4:83 BD F2 58
```

- select the required flag with hot keys (the selected flag appears in the upper line binary coded)
- press *OK* to edit the selected flag in the upper line.

8.3 Slave Adr Tool (slave addressing tool)

This function sets and changes the addresses of both new and configured AS-i slaves. This function replaces the handheld AS-i address programming device.

```
AS-I CIRCUIT 1
AS-I CIRCUIT 2
```

Please note that you must have selected the desired AS-i circuit using the arrow and the OK button when you operate a device with two AS-i circuits (see chapter 8.5.1).

```
SLAVE ADR TOOL
CONNECT NEW SLV
OLD ADDRESS
NEW ADDRESS
```

Now the new slave can be connected to the AS-i circuit. After connecting the actual address of the slave is displayed by "OLD ADDRESS".and the notice "CONNECT NEW SLV" disappears.

To give the slave a new address choose the menu entry "NEW ADDRESS". Afterwards the address can be selected with the help of the arrow buttons.The (re-)addressing is carried out by selecting the menu entry "PRG" and pressing the OK button.

```
SLAVE ADR TOOL
OLD ADDRESS 21A
NEW ADDRESS 03B
PRG
```

If an error occurs while addressing a slave, one of the following error messages is displayed for about 2 seconds:

- Failed: SND:slave with old address has not been detected.
- Failed: SD0:slave with address zero has been detected.
- Failed: SD2:slave with new address has been detected.
- Failed: DE:could not delete old address.
- Failed: SE:error setting new address.
- Failed: AT:new address could be stored temporarily only.
- Failed: RE:error reading the extended ID-code 1.

8.4 Slave Test Tool

With this function a single AS-i slave can be tested.

Please note that you must have selected the desired AS-i circuit using the arrow and the OK button when you operate a device with two AS-i circuits (see chapter 8.5.1)

```
AS-I CIRCUIT 1
AS-I CIRCUIT 2
```

Now a warning message is displayed, that possibly by this test outputs are set and the host may loose control of the circuit.

To start the test press the OK button, to cancel press the button ESC.

```
WARNING:  
OUTPUTS MAY BE  
SET AND HOST MAY  
LOSE CONTROL
```

In the following menu the slave to be tested has to be chosen by selecting the slave address.

Afterwards the test is started by confirming the menu entry "Test".

```
SLAVE TEST TOOL  
SLAVE ADR  21A  
TEST
```

After finishing the test all relevant informations is displayed for the tested slave. A successful test is displayed with "OK" below the address of the tested slave.

The following information are displayed:

- Address of the tested slave
- Existing errors are indicated
- Binary inputs (digital inputs), see also "Binary input", chapter 8.6.3
- Binary outputs (digital outputs), see also "Binary outputs", chapter 8.6.4
- Analog inputs, see also "Analog inputs", chapter 8.6.5
- Analog outputs, see also "Analog outputs", chapter 8.6.6
- Param (actual parameters), see also "Parameter", chapter 8.6.7
- Perm Param (projected parameters), see also "Permanent Param (projected parameter)", chapter 8.5.7
- Config (actual configuration), see also "Actual Config (actual configuration)", chapter 8.7.4
- Perm Conf (projected configuration), see also "Permanent Config (projected configuration data)", chapter 8.5.8

```

SLAVE 15 OK
BINARY INPUTS
  0 1
BINARY OUTPUTS
  0 1
ANALOG INPUTS
0 +17898
1 +32767 OVERFL
ANALOG OUTPUTS
0 +1789
1 +2500
PARAM          F
PERM PARAM     F
CONFIG         7FFE
PERM CONF      7FFE
    
```

8.5 Setup (configuration of AS-i circuit)

8.5.1 AS-i circuit

```

AS-I CIRCUIT 1
AS-I CIRCUIT 2
    
```

To reach this setup menu you have to change the desired AS-i circuit by using the arrow and the OK buttons.

The function is only implemented in the double master.

It makes possible to change the AS-i circuit that is currently active for being operated.

The active circuit is marked by the cursor.

8.5.2 Description of setup mode

```

AS-I SLAVE ADDR
FORCE OFFLINE
OPERATION MODE
STORE ACT CFG
PERMANENT PARAM
PERMANENT CFG
ADDR. ASSISTANT
LOS
AUTO ADDR ENABLE
SUPPLY
FACTORY RESET
    
```

Within the menu "Setup", one of the following submenus can be chosen:

- AS-i Slave Addr (AS-i Slave Address)
- Force Offline (switch AS-i Master offline)

- Operation Mode
- Store Act Cfg (store actual detected configuration)
- Permanent Param (projected parameter)
- Permanent Cfg (projected configuration data)
- Addr. Assistant (address assistant)
- LOS (list of offline-slaves)
- Auto Adr Enable
- Supply (option by single master)
- Factory Reset (rest for the factory adjustment)

8.5.3 AS-i Slave Adr (set/change slave address)

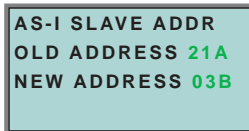

With this function the address of a slave can be changed.

To change the address select the menu entry "OLD ADDRESS" and afterwards select the address of the slave which address should be changed. The new address of the slave has to be set in the menu entry "NEW ADDRESS". The addressing is carried out by pressing the OK button.

8.5.4 Force offline

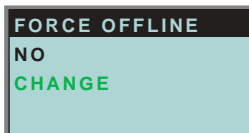

This function shows the current state of the AS-i Master:

Yes:AS-i Master is offline.

No:AS-i Master is online.

With "Change", this state can be modified.

Switching the AS-i master offline puts the AS-i circuit into the safe state. The AS-i master has to be offline if an AS-i slave should be addressed via the IR-interface.

8.5.5 Operation mode

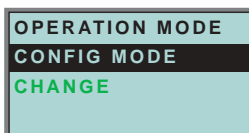

This function shows the current operation mode of the AS-i master:

Protected Mode:Protected mode

Config Mode:Configuration mode

With "Change" the operation mode can be changed.

Only in configuration mode parameters and configuration data can be stored.

8.5.6 Store Act Cfg (store actual detected configuration)

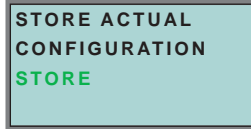

This function can only be executed in configuration mode.

This function enables you to store the configuration of all slaves which are connected and detected on the selected AS-i circuit.

If "Store" was successful, the LED "Config error" is off. The configuration is stored, the configuration error has been eliminated.

If one of the connected slaves has a peripheral fault, the LED "Config error" will flash.

If the AS-i master is in protected mode, the following error message will appear: "Failed No Config Mode"

If an AS-i slave with address zero exists, storing the configuration will be confirmed with "OK". However, the configuration error remains because address zero is not a valid operating address for storing a slave.

8.5.7 Permanent Param (projected parameter)



This function allows you to set the permanent parameters. A list of all slaves is displayed from 1A - 31A and from 1B - 31B. The permanent parameters for single slaves are set from address 1A - 31A. The parameter is shown as a hexadecimal value behind the slave address.

8.5.8 Permanent Config (projected configuration data)

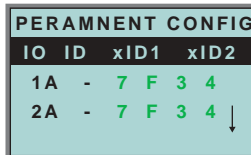

With this function the projected configuration data can be projected. The values for the configuration data are displayed behind the slave address in the following order:

IO (I/O-configuration) ID (ID-configuration) xID1 (extended ID1) xID2 (extended ID2).

Issue date - 20.4.2007

8.5.9 AS-i address assistant

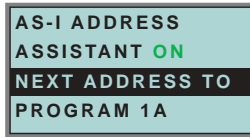

The AS-i address assistant helps you to set up the AS-i circuit quickly. Once you have stored the AS-i configuration, the AS-i address assistant addresses a new AS-i slave with address zero to the desired address.

Selecting "Assistant on" or "Assistant off" switches the AS-i address assistant on or off. The current state of the AS-i address assistant is displayed:

Assistant on: AS-i address assistant is switched on.

Assistant off: AS-i address assistant is switched off.

Procedure:

1. Store AS-i Configuration to the master. This can be done very comfortably with the Windows software AS-i-Control-Tools (Master | Write configuration to the AS-i Master ...), or directly with the fullgraphic display (see chapter 8.5.8).
2. All AS-i slaves have to be addressed to 0 or to the desired address. The slaves must be disconnected from the AS-i circuit.
3. Start the AS-i address assistant.
4. Now connect the AS-i slaves one after the other. The last line of the display of the AS-i address assistant shows which AS-i slave has to be connected next.

8.5.10 LOS (list of offline slaves)



See also "Advanced Diagnostics for AS-i Masters", chapter 9.

With "Clear all" and "Set all" you can delete or set a single bit for each AS-i slave address. Underneath there is a list of all slaves, by which the LOS bit can be set or deleted by individually selecting of the LOS bit.

Empty field: LOS bit deleted

X: LOS bit set

8.5.11 Auto Adr Enable (enable automatic address)



With this function can the programming of the automatic address be released or locked.

Meaning of the displayed mode:

Enable: Automatic address programming is released.

Disable: Automatic address programming is locked.

With "Change" the operation mode can be changed.

8.5.12 Factory reset



With this function the master can be reseted to the factory setting. The reset can be chosen by selecting the menu entry "DO RESET".

 <p>Warning</p>	<ul style="list-style-type: none">• This function should be used only in an emergency, since all attitudes transacted so far are put back to factory setting and thus perfect communication and functioning of the masters with the AS-i circle are ensured no more.• The master and the AS-i circuit have to be recommissioned and reprojected again after a successful "Reset".• In case of double masters the "Reset" acts on both AS-i masters!
--	---

8.6 IO + Param. Test

8.6.1 AS-i circuit

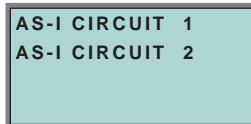

To reach this setup menu you have to change the desired AS-i circuit by using the arrow and the OK buttons.

The function is only implemented in the double master.

It makes possible to change the AS-i circuit that is currently active for being operated.

The active circuit is marked by the cursor.

8.6.2 IO + Param. Test (Testing AS-i In- and Outputs as well as reading and writing AS-i Parameters)

WARNING
OUTPUTS MAY BE
SET AND HOST MAY
LOSE CONTROL.

Before changing to the menu the following warning message will be displayed:

"Warning: Outputs may be set and Host may lose control."

BINARY INPUTS
BINARY OUTPUTS
ANALOG INPUTS
ANALOG OUTPUTS

The menu "IO + Param.Test" enables you to choose one of the following submenus:

- Binary Inputs
- Binary Outputs
- Analog Inputs
- Analog Outputs
- Parameter

8.6.3 Binary input

BINARY INPUTS
D3...D0
1A - 0 1 0 1
2A - 0 1 0 1
3A - 0 0 0 1 ↓

This list shows the state of the binary inputs for all AS-i slaves.

0: Input deleted

1: Input set

8.6.4 Binary outputs

BINARY OUTPUTS	
D3...D0	
1 A	0 1 0 1
2 A	0 1 0 1
3 A	0 0 0 1 ↓

This function shows the state of the binary outputs for all AS-i slaves.

- 0: Output deleted
- 1: Output set

The binary outputs can be changed after selecting the desired AS-i slave.

8.6.5 Analog inputs

ANALOG INPUTS	
1	X
2	A
3	B

This function shows the state of the analog inputs for all AS-i slaves.

The slave-types are characterized as follows:

- X** - single slave
- A** - A-slave
- B** - B-slave
- AB** - A+B slave

...

The data of the slave B start ex channel 2!

The display is as follows:

AS-i slave address, hexadecimal 16 bit value, bar display indicating the input or output value.

An eventual value overflow is displayed by "Overfl" additionally.

ANALOG IN 1	
0	+2500
1	+17898
2	+32767 OVERFL
3	-20023

8.6.6 Analog outputs

ANALOG OUTPUTS	
1	X
2	A
3	B

This function shows the state of the analog outputs for all AS-i slaves.

The display is as follows:

AS-i slave address, hexadecimal 16 bit value, bar display.

OVERFL displays any value overflows additionally.

ANALOG OUT 1	
0	+2500
█	
1	+17898
██	
2	+32767 OVERFL
██████████	
3	-20023
███	

The analog outputs can be changed after selecting the desired AS-i slave.

8.6.7 Parameter

PARAMETER	
I	1A - 0
2A - 2	I 3A - F
4A - E	I 5A - 3
↓	

This function shows the hexadecimal value of the current AS-i parameters for all AS-i slaves.

The actual AS-i parameters can be changed after selecting the desired slave address.

8.7 Diagnosis (normal AS-i diagnosis)

8.7.1 AS-i circuit

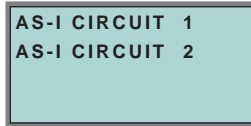

To reach this setup menu you have to change the desired AS-i circuit by using the arrow and the OK buttons.

The function is only implemented in the double master.

It makes possible to change the AS-i circuit that is currently active for being operated.

The active circuit is marked by the cursor.

8.7.2 Diagnosis (normal AS-i diagnosis)

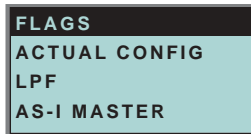

The menu "Diagnosis" enables you to choose one of the following submenus:

- Flags (EC-Flags: Execution control flags)
- Actual Config (actual configuration)
- LPF (list of periphery faults)
- AS-i Master (Info)

8.7.3 Flags

```

FLAGS:  0131 05
           0000 0001
           0011 0001
           0000 0101
1  PERIPHERY_OK
0  OFFLINE_READY
0  AS-I_PWR_FAIL
1  NORMAL_OP.
1  CONFIG_ACTIVE
0  AUTO_ADDR_AVL
0  AUTO_ADDR_ASN
0  LDS.O
1  CONFIG_OK

1  AUTO_ADDR_ENA
0  OFFLINE
1  DATA_EXCH_ACT
    
```

This function shows the EC-flags hexadecimally, binary and as single bits beginning with the lowest-order bit.

Arrangement of the bits within the byte:

Byte								
Bit value:	2 ⁷	2 ⁶	2 ⁵	2 ⁴	2 ³	2 ²	2 ¹	2 ⁰
Bit.	7	6	5	4	3	2	1	0

Byte 1:

Bit 0: Periphery_OK

This flag is set, if no AS-i slave signs a periphery fault.

Byte 2:

Bit 0:Config_OK

The flag is set, if the projected configuration corresponds with the actual configuration.

Bit 1:LDS.0

The flag is set, if an AS-i slave with address 0 has been detected.

Bit 2:Auto_Addr_Asn

The flag is set, if the automatic addressing is possible (AUTO_ADDR_ENABLE = 1; no "incorrect" AS-i slave is connected to AS-i).

Bit 3:Auto_Addr_Avl

The flag is set, if the automatic addressing is possible. This means that exactly one slave is failed.

Bit 4:Config_Active

The flag is set in the configuration mode and is reset in the protected mode.

Bit 5:Normal_Op.

The flag is set, if the AS-i master is in normal operation.

Bit 6:AS-i Pwr Fail

The flag is set, if the AS-i circuit is not sufficiently powered.

Bit 7:Offline_Ready

The flag is set, if the AS-i master is in the offline phase.

Byte 3:

Bit 0:Data_Exch_Act

If the flag "Data Exchange Active" is set, the data exchange is released with the AS-i slaves in the data exchange phase. If the bit is not set, the data exchange with AS-i slaves will be locked. Instead of data telegrams READ_ID telegrams will be sent.

The bit is set by the AS-i master by change over in the offline phase.

Bit 1:Offline

This bit is set if the operating mode offline is to be or already taken.

Bit 2:Auto_Addr_Ena

This flag indicates if the automatic addressing is locked (bit = 0) or released (bit = 1) by the user.

8.7.4 Actual Config (actual configuration)

ACTUAL CONFIG		
0A	I	1 A-Cf
2Ax	I	3Ad
4p	I	5A
		↓

This function shows the state of the actual configuration of the individual AS-i slaves.

At the end of the list there is a help text describing the abbreviations:

X (O.K.):The configuration data of the detected AS-i slave matches the projected configuration data.

D (Detected Only):An AS-i slave is detected at this address, but not projected.

P (Projected Only):An AS-i slave is projected at this address, but not detected.

C (Type Conflict):The configuration data of the detected AS-i slave does not match the projected configuration data. The actual detected configuration of the connected AS-i slave is displayed.

F (Periph. Fault):The AS-i slave has a peripheral fault.

A (Duplicate Adr.):2 AS-i slaves in the indicated address

After selecting the desired AS-i slave address the values for the actual configuration data are displayed behind the respective address in the following order:

IO (I/O-configuration) ID (ID-configuration) xID1 (extended ID1)
xID2 (extended ID2)

0A - -
1A - 7A28 - C
TYPE CONFLICT

Furthermore the state of the configuration is displayed in plain text.

If no AS-i slave is detected and no AS-i slave is projected at a certain address, four dots instead of the configuration data are displayed.

8.7.5 LPF (List of periphery faults)

LPF LIST OF PERIPH. FAULTS		
	I	1A-x
2A-	I	3A-
		↓

The list shows AS-i slaves, which have released a peripheral fault.

Empty field: Periphery O.K.

X: Peripheral fault

8.7.6 AS-i master (info)

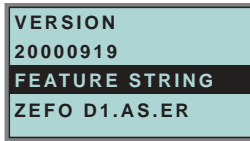

This function shows information about the version and the features of the AS-i master.

Version xxxxxxxx (date of the firmware)

Feature String xxxxxxxxxxxxxxxxx

8.8 Adv. Diagnosis (advanced AS-i diagnosis)

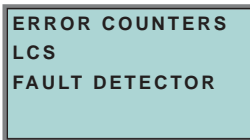

See also "Advanced Diagnostics for AS-i Masters", chapter 9.

In the menu "Adv. Diagnosis", the following submenus can be found:

- Error Counters
- LCS (list of slaves, that produced a configuration error)
- Fault Detector

8.8.1 Error counters

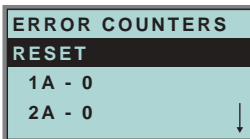

This list shows the error counter for each single AS-i slave.

Furthermore the number of power failures on AS-i (APF) is displayed.

By selecting "Reset", the error counters are reset to 0.

8.8.2 LCS (list of slaves having caused a configuration error)

RESET			
APF-	I	1A-x	↑
2A-	I	3A-	
4A-x	I	5A	↓

This list shows for each single AS-i slave whether at least one configuration error was caused by an enormous telegram transmission. This function is especially important if the configuration error only occurs short-time.

Empty field: No error

X: AS-i slave caused a configuration error.

8.8.3 Fault detector

FAULT DETECTOR
RESET
HISTORIC:
EFLT OVRV NOIS
ACTUAL:
EFLT OVRV NOIS
DUP ASI ADR:
0 I 31B
HELP:
EFLT EARTH FAULT
OVRV OVERVOLTAGE
NOIS NOISE
DUP ASI ADR
DUPLICATE ASI
SLAVE ADDRESS

The menu "Fault Detector" shows information about the AS-i detector and allows deleting of the AS-i detector's history. Furthermore a list of abbreviations in plain language can be found in the section "Help".

By selecting "Reset" the history of the AS-i detector can be deleted.

In the section "Historic" the appeared error messages of the AS-i detector are listed since the last "Reset".

In the section "Actual" the actual appeared error messages of the AS-i detector are listed.

Following error messages are possible:

- Duplicate address (the 2 lowest slave addresses are displayed, at which a duplicate address exist).
- Earth faults
- Noise
- Overvoltage

8.9 AS-i safety



This function shows information about the safety slaves and the safety monitor:

- Safety Slaves
- Safety Monitor
- Safety Substitute Value

8.9.1 Safety slaves (safety oriented slaves)

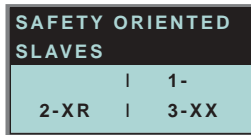

This list shows the "safety-directed input slaves" ("AS-i Safety at Work"), by which the safety function is released.

X:channel o.k.

R:channel has released

The first area corresponds with the channel 2, the second one with the channel 1. XR means also: channel 2 is OK and channel 2 has released.

The channels can not be evaluate individually, if the substitution of safety slaves input data was disconnected in menu:

- command interface/ function profile

or

- slave value substitute.

Both channels must have the same state, otherwise the indication will not be proper.

8.9.2 Safety monitor

SAFETY MONITOR DIAGNOSIS	
ADDR:	17
MODE:	SORTED/V1
STATUS:	O.K.
CH.1:	OFF
CH.2:	OFF
1-32:	GREEN
...	

The AS-i safety monitor reads the diagnosis data of the AS-i safety monitor and shows on the display. The meaning of the shown diagnosis can be seen in the description of the safety monitor.

8.9.3 Safety Subst Value

SAFETY SUBST VAL SUBSTITUTE
CHANGE

With this function the input-data-substitution by safety slaves can be turn off/on.
SUBSTITUTE

The input-data are replaced mit following values:

Both channels released: 0000bin

Channel 1 released: 0011bin

Channel 2 released: 1100bin

No channel has released: 1111bin

NO SUBSTITUTE

The safety slave input data are shown unmodified.

8.10 Display contrast



With this function display contrast can be adjusted.
Factory adjustment will be reloaded by selecting DEAFULT.

Approach to set the display contrast:

- select the bar line with soft keys
- verify with *OK* (the bar line flashes)
- set the display contrast with soft keys
- assume with *OK*.

If the contrast is completely misaligned, set it as follows:

- turn the master off
- press the buttons *MODE + SET* and hold them
- turn the master on.

8.11 Language of displayed messages

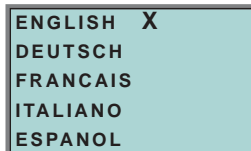

The list of **messages** (like "missing slave" or "unknown slave") that is shown on the screen, can be edited in the desired language by using the softkey + *OK* buttons. The current language is marked with "x".



Note

The menu-language is English. This attitude cannot be changed! It is only possible to change the language of displayed messages (like "missing slave" or "unknown slave").

9 Advanced Diagnostics for AS-i Masters

The advanced AS-i diagnostics serve to locate occasionally occurring errors and to judge the quality of data transmission on AS-i without additional diagnostics tools.

AS-i Control Tools (software for comfortable commissioning of AS-i and programming of AS-i Control) supports the operation of the advanced diagnostics (LCS, error counters and LOS).

9.1 List of corrupted AS-i Slaves (LCS)

The *LCS* contains the history of the delta list. Besides the list of projected slaves (*LPS*), the list of detected slaves (*LDS*) and the list of activated slaves (*LAS*), a fourth list, the **list of corrupted slaves (LCS)**, is created by AS-i masters with advanced diagnostics in order to locate occasionally occurring short-time configuration errors. This list contains entries of all AS-i slaves which were responsible for at least one configuration error since powering up the AS-i master or reading the list. Short-time AS-i power failures are listed in the *LCS* at the position of AS-i slave with address 0.

 Note	With every read-access the LCS will be deleted.
--	---

 Note	<p>The last short-time configuration error can also be displayed on the AS-i master:</p> <ul style="list-style-type: none"> • Pressing the "Set" button of the AS-i master shows the AS-i slave which was responsible for the last short-time configuration error. If there was a short-time AS-i power failure the display shows "39" after pressing the "Set" button. • This function is only available if the device is in the normal operation mode of the protected mode (display empty) or in the off-line-phase.
--	---

9.2 Protocol analysis: counters of corrupted data telegrams

The AS-i master with advanced diagnostics has a counter of telegram repetitions for each AS-i slave, which count up every time a corrupted data telegram has been found. This makes possible to judge the quality of the AS-i network, even if only a few corrupted telegrams occurred and the AS-i slave did not cause any configuration errors.

 Note	<ul style="list-style-type: none"> • The counter values can be read via the host interface and will be deleted with every read access. • The counter value is limited to 254. 255 will cause a counter overflow.
--	--

The protocol analysis is included in the software **AS-i Control Tools** by using the command master | AS-i Diagnostics.

9.3 Offline phase on configuration errors (LOS)

The AS-i masters with advanced diagnostics offer the possibility to put themselves into the offline phase when a configuration error on the AS-Interface occurs. This way the security of the application can be ensured. The reaction to a configuration error is very fast and the host can be relieved from this task. If there are any problems on the AS-i network, the AS-i can be switched to a secure state.

There are two different ways to parameterize the AS-i master for this feature:

- Every configuration error during normal operation in protected mode releases the off-line phase.
- For each slave address, it can be chosen whether a configuration error on this address will cause the offline phase or not. This information is stored in the list of offline slaves (LOS).

The user himself can decide how the system reacts to a configuration error on the AS-i. The AS-i master can release the off-line phase in critical situations, i. e. only with certain slave addresses, whereas in less critical situations (if one of the other AS-i slaves has a configuration error) only the error message is sent to the host, but AS-i is still running.

The parameterization "off-line phase on configuration error" is also supported by the "AS-i-Control-Tools" (command Master | Identity | Offline on configuration error).

Two ways to reset the error message "OFFLINE BY LOS" are possible:

1. Deleting of the complete list LOS of the affected AS-i circuit ("CLEAR ALL").
2. Voltage reset at the affected AS-i circuit.

 <p>Attention</p>	<p>By voltage reset at the AS-i circuit 1 the complete double gateway will be shut down.</p>
--	--

9.4 Functions of the AS-i fault detector

9.4.1 Duplicate address' recognition

If two slaves have the same address in an AS-i circuit, a duplicate address exists. Because of this error the master can not send a request to each slave separately. At that time both responses overlap themselves on the line, it is impossible for the master to recognize the slave response safely. It exists an unstable network behaviour.

The function "duplicate address' recognition" allows to recognize a duplicate address and to indicate this both via DeviceNet and in the AS-i Control Tools.

A duplicate address causes a configuration error and will be shown in the display of the master.

 Note	<p>Duplicate addresses can be recognized only in the AS-i segment directly at the master. If both slaves participate in a duplicate address located behind a repeater, the <i>duplicate address' recognition</i> is impossible.</p>
--	---

9.4.2 Earth fault detector

An *Earth Fault* exists when the tension **U_{GND}** (Nominal value of $U_{GND}=0,5 U_{AS-i}$) is outside of the following range:

$$10\% U_{AS-i} \leq U_{GND} \leq 90\% U_{AS-i}$$

This error limits the fail-safe characteristic of the AS-i transmission substantially. Earth faults are indicated in the master's display and AS-i Control Tools.

 Note	<p>By a double master in version 1 power supply for 2 AS-i circuits an earth fault in one of the both circuits causes also an earth fault in the other circuit because of the existing galvanic connection.</p>
--	---

 Note	<p>For recognition of earth faults the master must be grounded with the function earth.</p>
--	---

9.4.3 Noise detector

The noise detector detects alternating voltages on AS-i, which are not produced by AS-i master or AS-i slaves. These interference voltages can cause telegram disturbances.

A frequent cause are insufficiently shielded frequency inverters or awkwardly shifted cables.

Noises are indicated in the master's display and the AS-i Control Tools.

9.4.4 Overvoltage detector

Overvoltages are present, if the AS-i line, whose veins lie normally electrically symmetrically to the plant earth, are strongly electrically raised. A cause can be e.g. power-on procedures of large consumers. However sometimes overvoltages don't generally disturb AS-i communication, but can release incorrect signals of sensors.

Overvoltages are indicated in the master's display and the AS-i Control Tools.

10 DeviceNet Interface

The AS-i 3.0 DeviceNet Gateway operates as a Group 2-Only slave device on the DeviceNet network, supporting polled I/O and explicit messaging. It does not support strobed I/O.

This appendix defines DeviceNet message types, class services and object classes that are supported by the AS-i 3.0 DeviceNet Gateway.

10.1 DeviceNet Message Types

The gateway supports the following message types:

CAN Identifier Field	Group 1 Message Type
01101xxxxx	Slave's I/O Change of State or Cyclic Message
01111xxxxx	Slave's I/O Poll Response or Change of State/Cyclic Acknowledge Message

CAN Identifier Field	Group 2 Message Type
10xxxxx111	Duplicate MAC ID Check Messages
10xxxxx110	Unconnected Explicit Request Messages
10xxxxx101	Master I/O Poll Command Message
10xxxxx100	Master Explicit Request Message
10xxxxx010	Master's I/O Poll/Change of State/Cyclic Message

 Note	xxxxxx = AS-i 3.0 DeviceNet Gateway node address.
--	---

10.2 DeviceNet Class Services

The gateway supports the following class services and instance services:

Service Name	Service Code
Reset	0x05
Delete	0x09
Get_Attribute_Single	0x0E
Set_Attribute_Single	0x10
Allocate Master/Slave_Connection_Set	0x4B
Release Master/Slave_Connection_Set	0x4C

10.3 Object Modelling

According to the DeviceNet philosophy, one should model the properties of the physical device in DeviceNet Objects. For an AS-i Master, the objects could be:

- An "AS-i Master Object" which contains the properties of the Master itself and of the whole AS-i circuit, e.g. ec-flags, lists and functions for slave programming and so on.
- "AS-i Slave Objects", one for every AS-i slave which contains the properties of the individual AS-i slave, e.g. parameters, configuration and so on.

Therefore following Object List ist existing (overview):

Class Code	Object Name	Number of Instances
0x01	Identity	1
0x03	DeviceNet	1
0x04	Assembly	72
0x05	Connections	4
0x15	Parameter object	1
0x64	AS-i master	1 for each AS-i circuit
0x65	AS-i slave	64 for each AS-i circuit
0x66	E/A data	1 for each AS-i circuit
0x67	Advanced diagnostics	1 for each AS-i circuit
0x68	Short command interface	1
0x69	Long command interface	1

10.3.1 Identity Object

Class Code: 1 (0x01)

Number of instances: 1

Instance Attributes

Attribute ID	Access Rule	Name	Value
100	Get	Vendor	645
101	Get	Device Type	100
102	Get	Product Code	single master: 1818 double master: 1820
103	Get	Revision	2.2
104	Get	Status	see overwiev listed below
105	Get	Serial Number	unique number, 32-bit
106	Get	Product Name	AS-i 3.0 DeviceNet Gateway
109	Get/Set	Heartbeat Interval	

Status

Bit 0	owned	0 = not owned 1 = owned (group 2 allocated to master)
Bit 1	reserved	always 0
Bit 2	configured	always 0
Bit 3	reserved	always 0
Bit 4-7	vendor specific	all 0
Bit 8	minor cfg. fault	0 = no error 1 = minor configuration fault
Bit 9	minor device fault	0 = no error 1 = minor device fault
Bit 10	major cfg. fault	0 = no error 1 = major configuration fault
Bit 11	major device fault	0 = no error 1 = major device fault
Bit 12,13	reserved	always 0
Bit 14,15	reserved	always 0

Common Services

Service Code	Class	Instance	Service Name
0x05	no	yes	Reset
0x10	yes	yes	Get_Attribute_Single
0x0E	yes	yes	Get_Attribute_Single

10.3.2 DeviceNet Object

Class Code: 3

Number of Instances: 1

Instance Attributes

Attribute ID	Access Rule	Name	DeviceNe Data Type	Data Value
1	Get/Set	MAC ID	USINT	Range 0-63
2	Get/Set	Baud Rate	USINT	Range 0-2
3	Get/Set	BOI	BOOL	Range 0-1
4	Get/Set	Bus-off Counter	USINT	Range 0-255
5	Get	Allocation Information: Allocation Choice Byte Master's Node Address	Structure of: BYTE USINT	0-63=Master Address 255=unallocated

Common Services

Service Code	Class	Instance	Service Name
0x0E	yes	yes	Get_Attribute_Single
0x10	no	yes	Set_Attribute_Single
0x4B	no	yes	Allocate_M/S_Connection_Set
0x4C	no	yes	Release_M/S_Connection_Set

10.3.3 Assembly Object

Class Code 4 (0x04)

Number of instances: 72

The Assembly Object bundles data from the application objects.

The Assembly Object Instances consist of (in case of a double master):

- A-slaves and/or single slaves from circuit 1
- Single, A- and B-slaves (all slaves) from circuit 1
- A-slaves and/or single slaves from both circuits
- Single, A- and B-slaves (all slaves) from both circuits
- No 16-bit data
- 16-bit data from slaves 29 ... 31 from circuit 1
- 16-bit data from slaves 29 ... 31 from both circuits
- No command interface
- Short command interface
- Long command interface

Attribute ID	Access Rule	Name	Data Value
3		Data Item(s)	

Instances 100 (0x64) ... 135 (0x87) can only be read, while instances 136 (0x88) ... 171 (0xAB) can be read and written.

Assembly Instance		Data Item			
Input	Output	Size (Byte)	Digital	Analog	Command interface
100 (0x64)	136 (0x88)	16	AS-i circuit 1, Single- and A-slaves		
101 (0x65)	137 (0x89)	28	AS-i circuit 1, Single- and A-slaves		short
102 (0x66)	138 (0x8A)	52	AS-i circuit 1, Single- and A-slaves		long
103 (0x67)	139 (0x8B)	40	AS-i circuit 1, Single- and A-slaves	AS-i circuit 1, Analog slaves 29 ... 31	
104 (0x68)	140 (0x8C)	52	AS-i circuit 1, Single- and A-slaves	AS-i circuit 1, Analog slaves 29 ... 31	short
105 (0x69)	141 (0x8D)	76	AS-i circuit 1, Single- and A-slaves	AS-i circuit 1, Analog slaves 29 ... 31	long
106 (0x6A)	142 (0x8E)	64	AS-i circuit 1, Single- and A-slaves	AS-i circuite 1+2, Analog slaves 29 ... 31	
107 (0x6B)	143 (0x8F)	76	AS-i circuit 1, Single- and A-slaves	AS-i circuite 1+2, Analog slaves 29 ... 31	short
108 (0x6C)	144 (0x90)	100	AS-i circuit 1, Single- and A-slaves	AS-i circuite 1+2, Analog slaves 29 ... 31	long
109 (0x6D)	145 (0x91)	32	AS-i circuit 1, all slaves		
110 (0x6E)	146 (0x92)	44	AS-i circuit 1, all slaves		short
111 (0x6F)	147 (0x93)	68	AS-i circuit 1, all slaves		long
112 (0x70)	148 (0x94)	56	AS-i circuit 1, all slaves	AS-i circuit 1, Analog slaves 29 ... 31	
113 (0x71)	149 (0x95)	68	AS-i circuit 1, all slaves	AS-i circuit 1, Analog slaves 29 ... 31	short
114 (0x72)	150 (0x96)	92	AS-i circuit 1, all slaves	AS-i circuit 1, Analog slaves 29 ... 31	long
115 (0x73)	151 (0x97)	80	AS-i circuit 1, all slaves	AS-i circuite 1+2, Analog slaves 29 ... 31	
116 (0x74)	152 (0x98)	92	AS-i circuit 1, all slaves	AS-i circuite 1+2, Analog slaves 29 ... 31	short
117 (0x75)	153 (0x99)	116	AS-i circuit 1, all slaves	AS-i circuite 1+2, Analog slaves 29 ... 31	long
118 (0x76)	154 (0x9A)	32	AS-i circuite 1+2, Single- and A-slaves		
119 (0x77)	155 (0x9B)	44	AS-i circuite 1+2, Single- and A-slaves		short
120 (0x78)	156 (0x9C)	68	AS-i circuite 1+2, Single- and A-slaves		long
121 (0x79)	157 (0x9D)	56	AS-i circuite 1+2, Single- and A-slaves	AS-i circuit 1, Analog slaves 29 .. 31	
122 (0x7A)	158 (0x9E)	68	AS-i circuite 1+2, Single- and A-slaves	AS-i circuit 1, Analog slaves 29 ... 31	short
123 (0x7B)	159 (0x9F)	92	AS-i circuite 1+2, Single- and A-slaves	AS-i circuit 1, Analog slaves 29 ... 31	long

Issue date - 20.4.2007

Assembly Instance			Data Item		
Input	Output	Size (Byte)	Digital	Analog	Command interface
124 (0x7C)	160 (0xA0)	80	AS-i circuite 1+2, Single- and A-slaves	AS-i circuite 1+2, Analog slaves 29 ... 31	
125 (0x7D)	161 (0xA1)	92	AS-i circuite 1+2, Single- and A-slaves	AS-i circuite 1+2, Analog slaves 29 ... 31	short
126 (0x7E)	162 (0xA2)	116	AS-i circuite 1+2, Single- and A-slaves	AS-i circuite 1+2, Analog slaves 29 ... 31	long
127 (0x7F)	163 (0xA3)	64	AS-i circuite 1+2, all slaves		
128 (0x80)	164 (0xA4)	76	AS-i circuite 1+2, all slaves		short
129 (0x81)	165 (0xA5)	100	AS-i circuite 1+2, all slaves		long
130 (0x82)	166 (0xA6)	88	AS-i circuite 1+2, all slaves	AS-i circuit 1, Analog slaves 29 ... 31	
131 (0x83)	167 (0xA7)	100	AS-i circuite 1+2, all slaves	AS-i circuit 1, Analog slaves 29 ... 31	short
132 (0x84)	168 (0xA8)	124	AS-i circuite 1+2, all slaves	AS-i circuit 1, Analog slaves 29 ... 31	long
133 (0x85)	169 (0xA9)	112	AS-i circuite 1+2, all slaves	AS-i circuite 1+2, Analog slaves 29 ... 31	
134 (0x86)	170 (0xAA)	124	AS-i circuite 1+2, all slaves	AS-i circuite 1+2, Analog slaves 29 ... 31	short
135 (0x87)	171 (0xAB)	148	AS-i circuite 1+2, all slaves	AS-i circuite 1+2, Analog slaves 29 ... 31	long

Instances 136 (0x88) ... 171 (0xAB) have the same structure but with 16-bit and binary outputs. They can be read and written.

The are only instances 100 (0x64) ... 105 (0x69) and 109 (0x6D) ... 114 (0x72) in case of a single master. In case of single master, instance 100 (0x64) is the default connection path for produced data and instance 136 (0x88) for consumed data.

In case of double master, instance 118 (0x76) is the default connectionn path for produced data and instance 154 (0x9A) for consumed data.

10.3.4 Connection Object

Class Code: 5

Number of Instances: 3



If the polled I/O message connection leaves the established state (3) the AS-i output data will be cleared.

Note

Instance 1 Attributes (Explicit Message Connection)

Attribute ID	Access Rule	Name	DeviceNet-Data Type	Data Value
1	Get	State	USINT	1 = configuring 2 = waiting for connection ID 3 = established 4 = timed out 5 = deferred delete
2	Get	Instance Type	USINT	0 = explicit message
3	Get	Transport Class Trigger	USINT	83 (hex.)
4	Get	Produced Connection ID	UINT	10xxxxx011 (binary) xxxxxx=Node Address
5	Get	Consumed Connection ID	UINT	10xxxxx100 (binary) xxxxxx=Node Address
6	Get	Initial Comm. Characteristics	USINT	21 (hex.)
7	Get	Produced Connection Size	UINT	204 (dec.)
8	Get	Consumed Connection Size	UINT	204 (dec.)
9	Get/Set	Expected Packet Rate	UINT	0 (ms)
12	Get	Watchdog Timeout Action	USINT	0 = timeout 1 = auto delete 2 = auto reset 3 = deferred delete
13	Get	Produced Connection Path Length	USINT	0
14	Get	Produced Connection Path		null (no data)
15	Get	Consumed Connection Path Length	USINT	0
16	Get	Consumed Connection Path		null (no data)
17	Get	Production Inhibit Time	UINT	

Common Services

Service Code	Class	Instance	Service Name
0x05	yes	yes	Reset
0x09	yes	yes	Delete
0x0E	yes	yes	Get_Attribute_Single
0x10	no	yes	Set_Attribute_Single

Instance 2 Attributes (Polled I/O Message Connection)

Attribute ID	Access Rule	Name	DeviceNet Data Type	Data Value
1	Get	State	USINT	1 = configuring 2 = waiting for connection ID 3 = established 4 = timed out 5 = deferred delete
2	Get	Instance Type	USINT	1 = I/O message
3	Get	Transport Class Trigger	USINT	83 (hex.)
4	Get	Produced Connection ID	UINT	01111xxxxx (binary) xxxxxx=Node Address
5	Get	Consumed Connection ID	UINT	10xxxxxx101 (binary) xxxxxx=Node Address
6	Get	Initial Comm. Characteristics	USINT	01 (hex.)
7	Get	Produced Connection Size	UINT	20 (hex.)
8	Get	Consumed Connection Size	UINT	20 (hex.)
9	Get/Set	Expected Packet Rate	UINT	0 (msec)
12	Get	Watchdog Timeout Action	USINT	0 = timeout 1 = auto delete 2 = auto reset 3 = deferred delete
13	Get	Produced Connection Path Length	USINT	6
14	Get/Set	Produced Connection Path	Structure of: USINT USINT USINT USINT USINT USINT Structure of: USINT USINT USINT USINT USINT USINT	single master (default): 20 (hex.) 04 (hex.) 24 (hex.) 64 (hex.) 30 (hex.) 03 (hex.) double master (default): 20 (hex.) 04 (hex.) 24 (hex.) 76 (hex.) 30 (hex.) 03 (hex.)
15	Get	Consumed Connection Path Length	USINT	6

16	Get	Consumed Connection Path	Structure of: USINT USINT USINT USINT USINT USINT Structure of: USINT USINT USINT USINT USINT USINT	single master (default): 20 (hex.) 04 (hex.) 24 (hex.) 88 (hex.) 30 (hex.) 03 (hex.) double master (default): 20 (hex.) 04 (hex.) 24 (hex.) 9A (hex.) 30 (hex.) 03 (hex.)
17	Get/Set	Production Inhibit Time		

Common Services

Service Code	Class	Instance	Service Name
0x05	yes	yes	Reset
0x09	yes	yes	Delete
0x0E	yes	yes	Get_Attribute_Single
0x10	no	yes	Set_Attribute_Single

Instance 4 Attributes (Cyclic/Change of State)

Attribute ID	Access Rule	Name	DeviceNet Data Type	Data Value
1	Get	State	USINT	1 = configuring 2 = waiting for connection ID 3 = established 4 = timed out 5 = deferred delete
2	Get	Instance Type	USINT	1 = I/O message
3	Get	Transport Class Trigger	USINT	12 (hex.)
4	Get	Produced Connection ID	UINT	01101xxxxx (binary) xxxxxx=Node Address
5	Get	Consumed Connection ID	UINT	10xxxxxx010(binary) xxxxxx=Node Address
6	Get	Initial Comm. Characteristics	USINT	01 (hex.)
7	Get	Produced Connection Size	UINT	20 (hex.)
8	Get	Consumed Connection Size	UINT	20 (hex)
9	Get/Set	Expected Packet Rate	UINT	0 (ms)
12	Get	Watchdog Timeout Action	USINT	0 = timeout 1 = auto delete 2 = auto reset 3 = deferred delete
13	Get	Produced Connection Path Length	USINT	6

Issue date - 20.4.2007

14	Get/Set	Produced Connection Path	Structure of: USINT 20 (hex.) USINT 04 (hex.) USINT 24 (hex.) USINT 64 (hex.) USINT 30 (hex.) USINT 03 (hex.) Structure of: USINT 20 (hex.) USINT 04 (hex.) USINT 24 (hex.) USINT 76 (hex.) USINT 30 (hex.) USINT 03 (hex.)	single master (default): 20 (hex.) 04 (hex.) 24 (hex.) 64 (hex.) 30 (hex.) 03 (hex.) double lmaster (default): 20 (hex.) 04 (hex.) 24 (hex.) 76 (hex.) 30 (hex.) 03 (hex.)
15	Get	Consumed Connection Path Length	USINT	4
16	Get	Consumed Connection Path	Structure: USINT 20 (hex) USINT 2B (hex) USINT 24 (hex) USINT 01 (hex)	single master (default): 20 (hex) 2B (hex) 24 (hex) 01 (hex)
17	Get/Set	Production Inhibit Time		

Common Services

Service Code	Class	Instance	Service Name
0x05	yes	yes	Reset
0x09	yes	yes	Delete
0x0E	yes	yes	Get_Attribute_Single
0x10	no	yes	Set_Attribute_Single

10.3.5 Parameter Object

Class Code: 15

Instance 1: I/O Data

Attribute ID	Access Rule	Name	DeviceNet Data Type	Data Value
1	Get/Set	Parameter Value	UINT	byte 1: Production Instance, byte 2: Consume Instance
2	Get	Link Path Size		0x00
3	Get	Link Path		
4	Get	Descriptor	UINT	0x20
5	Get	Data Type	EPATH	0xC7
6	Get	Data Size	USINT	0x02

With this parameter the DeviceNet POLL Connection Production/Consume Path and the Cyclic/COS Production Path can be easily modified. The values are the assembly instances of the Production and Consume Path. If the current path values are inconsistent for this parameter the reading is 0.

Byte 1 modifies the Production Path of the POLL and the Cyclic/COS connection. Byte 2 the Consume Path of the POLL Connection.

10.3.6 AS-i Master Object

Class Code: 100 (0x64)

1 instance for each AS-i circuit

Attribute ID	Access Rule	Name	DeviceNet Data Type	Default Data Value
100 (0x64)	Get	ec-flags	UINT (16-bit)	
101 (0x65)	Get/Set	hi-flags	USINT	
102 (0x66)	Get/Set	operational mode	BOOL	
103 (0x67)	Get	LDS	ULINT	
104 (0x68)	Get/Set	LPS	ULINT	
105 (0x69)	Get	LAS	ULINT	
106 (0x6A)	Get	LPF	ULINT	
107 (0x6B)	Get/Set	Store_Actual_Configuration	BOOL	
108 (0x6C)	Get/Set	Store_Actual_Parameters	BOOL	
109 (0x6D)	Get/Set	Change_Slave_Adress	UINT	
110 (0x6E)	Get/Set	Lock Pushbuttons	BOOL	

EC-flags (16-bit)

EC-flags (16-bit)								
2 ⁸	2 ⁷	2 ⁶	2 ⁵	2 ⁴	2 ³	2 ²	2 ¹	2 ⁰
Pok	OR	APF	NA	CA	AAv	AAAs	S0	Cok

- Pok Periphery_Ok
- S0 LDS.0
- AAAs Auto_Address_Assign
- AAv Auto_Address_Available
- CA Configuration_Active
- NA Normal_Operation_Active
- APF APF
- OR Offline_Ready
- Cok Config_Ok

Hi-flags (8-bit):

Hi-flags		
2^2	2^1	2^0
AAe	OL	DX

AAe Auto_Address_Enable
 OL Off-line
 DX Data_Exchange_Active

Operational mode (8-bit):

1: configuration mode
 0: protected mode

LDS, LAS, LPS, LPF (64-bit):

LDS, LAS, LPS, LPF								
byte	2^7	2^6	2^5	2^4	2^3	2^2	2^1	2^0
0	7A	6A	5A	4A	3A	2A	1A	0A
...	...							
7	31B	30B	29B	28B	27B	26B	25B	24B

Store actual parameter/store actual configuration/lock push-buttons:

True: proceed the action

Change slave address (16-bit):

Change slave address								
Byte	2^7	2^6	2^5	2^4	2^3	2^2	2^1	2^0
0	-		B	source address				
1	-		B	target address				

Meaning of the bit B:

B = 0: Single-AS-i slave oder A-slave
 B = 1: B-slave

10.3.7 AS-i Slave Object

Class Code: 101 (0x65)

64 instances for every AS-i circuit, 1 for every AS-i slave

Instance ID	AS-i-Slave
1	Slave 0, circuit 1
2	Slave 1A, circuit 1
...	...
32	Slave 31A circuit 1
33	empty, circuit 1
34	Slave 1B, circuit 1
...	...
64	Slave 31B, circuit 1
65	Slave 0, circuit 2
...	...
96	Slave 31A, circuit 2
97	leer, circuit 2
...	...
98	Slave 1B, circuit 2
...	...
128	Slave 31B, circuit 2

Attribute ID	Access Rule	Name	DeviceNet Data Type	Remark
0x64	Get	Actual configuration	UINT	
0x65	Get/Set	Permanent configuration	UINT	Slave 0, 32: not read-/writeable
0x66	Get/Set	Actual parameters	USINT	
0x67	Get/Set	Permanent parameters	USINT	
0x68	Get/Set	xID1	USINT	Slave 0: writeable only, slave 0 - 32: readable

Actual configuration/permanent configuration (16-bit):

Actual configuration/permanent configuration															
2 ¹⁵	2 ¹⁴	2 ¹³	2 ¹²	2 ¹¹	2 ¹⁰	2 ⁹	2 ⁸	2 ⁷	2 ⁶	2 ⁵	2 ⁴	2 ³	2 ²	2 ¹	2 ⁰
ID				IO				xID2				XID1			

Issue date - 20.4.2007

Parameter xID1 (8-bit):

Parameter xID1							
2 ⁷	2 ⁶	2 ⁵	2 ⁴	2 ³	2 ²	2 ¹	2 ⁰
-				data			

10.3.8 I/O Data Object

Class Code: 102 (0x66)

Input and Output Data

1 instance for each AS-i circuit

Attribute ID	Access Rule	Name	DeviceNet Data Type	Default Data Value
100 (0x64)	Get	Input Data Image, Single and A-slaves	ARRAY[16] of USINT	
101 (0x65)	Get	Input Data Image, B-slaves	ARRAY[16] of USINT	
102 (0x66)	Get/Set	Output Data Image Single and A-slaves	ARRAY[16] of USINT	
103 (0x67)	Get/Set	Output Data Image, B-slaves	ARRAY[16] of USINT	
104 (0x68)	Get	16-bit Input Data slave 1	ARRAY[4] of INT	
...
134 (0x86)	Get	16-bit Input Data slave 31	ARRAY[4] of INT	
135 (0x87)	Get/Set	16-bit Output Data slave 1	ARRAY[4] of INT	
...
165 (0xA5)	Get/Set	16-bit Output Data slave 31	ARRAY[4] of INT	

Input and Output Data Image:

Byte	2 ⁷	2 ⁶	2 ⁵	2 ⁴	2 ³	2 ²	2 ¹	2 ⁰
	F3	F2	F1	F0				
0	Flags				Slave 1/1A			
1	Slave 2/2A				Slave 3/3A			
2	Slave 4/4A				Slave 5/5A			
3	Slave 6/6A				Slave 7/7A			
4	Slave 8/8A				Slave 9/9A			
5	Slave 10/10A				Slave 11/11A			
6	Slave 12/12A				Slave 13/13A			
7	Slave 14/14A				Slave 15/15A			
8	Slave 16/16A				Slave 17/17A			
9	Slave 18/18A				Slave 19/19A			

Issue date - 20.04.2007

Byte	2 ⁷	2 ⁶	2 ⁵	2 ⁴	2 ³	2 ²	2 ¹	2 ⁰
10		Slave 20/20A				Slave 21/21A		
11		Slave 22/22A				Slave 23/23A		
12		Slave 24/24A				Slave 25/25A		
13		Slave 26/26A				Slave 27/27A		
14		Slave 28/28A				Slave 29/29A		
15		Slave 30/30A				Slave 31/31A		
16		reserved				Slave 1B		
17		Slave 2B				Slave 3B		
18		Slave 4B				Slave 5B		
19		Slave 6B				Slave 7B		
20		Slave 8B				Slave 9B		
21		Slave 10B				Slave 11B		
22		Slave 12B				Slave 13B		
23		Slave 14B				Slave 15B		
24		Slave 16B				Slave 17B		
25		Slave 18B				Slave 19B		
26		Slave 20B				Slave 21B		
27		Slave 22B				Slave 23B		
28		Slave 24B				Slave 25B		
29		Slave 26B				Slave 27B		
30		Slave 28B				Slave 29B		
31		Slave 30B				Slave 31B		

Flags		
	Input data	Output data
F0	ConfigError	Off-line
F1	APF	LOS-master-bit
F2	PeripheryFault	→ ConfigurationMode
F3	ConfigurationActive	→ ProtectedMode

ConfigError: 0=ConfigOK, 1=ConfigError
 APF: 0=AS-i-Power OK, 1=AS-i-Power Fail
 PeripheryFault: 0=PeripheryOK, 1=PeripheryFault
 ConfigurationActive: 0=ConfigurationActive, 1=ConfigurationInactive
 Off-Line: 0=On-Line, 1=Off-Line
 LOS-master-bit 0=Off-Line by ConfigError deactivated
 1=Off-Line by ConfigError activated.

16-bit values:

16-bit values															
2^{15}	2^{14}	2^{13}	2^{12}	2^{11}	2^{10}	2^9	2^8	2^7	2^6	2^5	2^4	2^3	2^2	2^1	2^0
D15	D14	D13	D12	D11	D10	D9	D8	D7	D6	D5	D4	D3	D2	D1	D0

16-bit data:

 Note	<p>A-Slaves map the data on channels 1 and 2. B-Slaves map the data on channels 3 and 4.</p>
--	---

In addition to the access via the command interfaces, the 16-bit data for or by the slaves with 16-bit value can be exchanged cyclically (profile 7.3., S-7.4, S-6.0, S-7.5, S-7.A.8, S-7.A.9, S-7.A.A). Competing writing access attempts on 16-bit output data will not be blocked by every other. If 16-bit data for a particular slave are being transmitted both cyclically and acyclically with the command interface or via DP V1 connections, the acyclically transmitted values will be overwritten by the cyclically transmitted values.

AS-i 16-bit data can be transmitted in a reserved data area. Therefore accessing 16-bit data is as easy as accessing digital data.

16-bit data								
Byte	2^7	2^6	2^5	2^4	2^3	2^2	2^1	2^0
1	Slave 31-n/8, channel 1, high byte							
2	Slave 31-n/8, channel 1, low byte							
3	Slave 31-n/8, channel 2, high byte							
4	Slave 31-n/8, channel 2, low byte							
...	...							
<i>n-3</i>	Slave 31, channel 3/Slave 31B, channel 1, high byte							
<i>n-2</i>	Slave 31, channel 3/Slave 31B, channel 1, low byte							
<i>n-1</i>	Slave 31, channel 4/Slave 31B, channel 2, high byte							
<i>n</i>	Slave 31, channel 4/Slave 31B, channel 2, low byte							

10.3.9 Advanced Diagnostics Object

Class Code: 103 (0x67)

1 instance for each AS-i circuit

Attribute ID	Access Rule	Name	DeviceNet Data Type	Default Data Value
100 (0x64)	get/set	los (list of offline slaves)	ULINT	
101 (0x65)	get	error counters a	ARRAY[32] of USINT	
102 (0x66)	get	error counters b	ARRAY[32] of USINT	

Error counter:

Single- and A-Slaves	
Index	Error Counter
1	Slave 1/1A
2	Slave 2/2A
3	Slave 3/3A
...	...
31	Slave 31/31A

B-Slaves	
Index	Error Counter
1	Slave 1B
2	Slave 2B
3	Slave 3B
...	...
31	Slave 31B

10.3.10 Short Command Interface Object

Class Code: 104 (0x68)

1 instance

Attribute ID	Access Rule	Name	DeviceNet Data Type	Default Data Value
100 (0x64)	get/set	content command toggle-bit and as-i circuit data	ARRAY[12] of USINT [0] [1] [2 ... 11]	

10.3.11 Long Command Interface Object

Class Code: 105 (0x69)

1 instance

Attribute ID	Access Rule	Name	DeviceNet Data Type	Default Data Value
100 (0x64)	get/set	content command toggle-bit and as-i circuit data	ARRAY[36] of USINT [0] [1] [2 ... 35]	

For special details acc. the command interface commands see <chapter 11>.

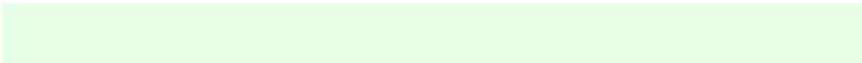

11 Command Interface

11.1 Construction

Command interface call-instructions are described as follows:

Request								
byte	2^7	2^6	2^5	2^4	2^3	2^2	2^1	2^0
1	command							
2	T	–	circuit					
3	request parameter byte 1							
...	...							
36	request parameter byte 34							

Response								
byte	2^7	2^6	2^5	2^4	2^3	2^2	2^1	2^0
1	command							
2	T	result						
3	response parameter byte 1							
...	...							
36	response parameter byte 34							

Command byte and T-bit are always part of the response. The T-bit is necessary to operate the command interface.

Command byte and T-bit are always part of the response. The T-bit is necessary to operate the command interface. This way the same command of the command interface can be used two twice repeatedly, possibly with different parameters.

The execution of a command interface is declined, if the command interface is too small.

Circuit = 0 If an AS-i gateway with one AS-i master or the master 1 of an AS-i gateway with 2 masters should be chosen.

Circuit = 1 If master 2 of an AS-i gateway with 2 masters should be chosen.

The commands for reading and writing exist in two variations. At the first variation the bits in the slave lists are arranged as usually with Pepperl+Fuchs products: Data for slave with lower address appear in the lower bits. The second variation is compatible to Siemens masters: The sequence of the bits in the slave lists bytes are inverse.

Switching between the two variations can be done with bit 2^6 in byte 2 of the request. If it is deleted, the Pepperl+Fuchs arrangement is selected, otherwise the Siemens compatible arrangement is selected.

The coding of requests for commands to reading and writing is following therefore:

Request								
byte	2^7	2^6	2^5	2^4	2^3	2^2	2^1	2^0
1	command							
2	T	0	circuit					
3	Request parameter byte 1							
...	...							

11.2 List of all commands

Values for command

see page	Command	Value	Meaning	Req Len	Res Len
page 84	AS-i 16-bit data				
page 84	RD_7X_IN	50 ₁₆	Read 1 16-bit slave profile in.data	3	10
page 85	WR_7X_OUT	51 ₁₆	Write 1 16-bit slave profile out.data	11	2
page 85	RD_7X_OUT	52 ₁₆	Read 1 16-bit slave profile out.data	3	10
page 86	RD_7X_IN_X	53 ₁₆	Read 4 16-bit slave profile in.data	3	34
page 86	WR_7X_OUT_X	54 ₁₆	Write 4 16-bit slave profile out.data	35	2
page 87	RD_7X_OUT_X	55 ₁₆	Read 4 16-bit slave profile out.data	3	34
page 87	OP_RD_16BIT_IN_CX	4C ₁₆	Read 16 channels 16-bit slave in.data	3	34
page 88	OP_WR_16BIT_IN_CX	4D ₁₆	Write 16 channels 16-bit slave in.data	36	2
page 89	Commands acc. to Profile S-7.4/S-7.5				
page 89	WR_74_75_PARAM	5A ₁₆	Write S-7.4/S-7.5-slave parameter	≥6	2
page 90	RD_74_75_PARAM	5B ₁₆	Read S-7.4/S-7.5-slave parameter	4	≥3
page 91	RD_74_75_ID	5C ₁₆	Read S-7.4/S-7.5-slave ID string	4	≥3
page 91	RD_74_DIAG	5D ₁₆	Read S-7.4/S-7.5-slave diagnosis string	4	≥3
page 92	Acyclic commands				
page 92	WRITE_ACYC_TRANS	4E ₁₆	Write acyclic transfer	≥7	2
page 94	READ_ACYC_TRANS	4F ₁₆	Read acyclic transfer	5	≥2
page 95	AS-i Diagnosis				
page 95	GET_LISTS	30 ₁₆	Get LDS, LAS, LPS, Flags	2	29
page 97	GET_FLAGS	47 ₁₆	Get_Flags	2	5
page 98	GET_DELTA	57 ₁₆	Get list of config. diff.	2	10
page 99	GET_LCS	60 ₁₆	Get LCS	2	10
page 99	GET_LAS	45 ₁₆	Get_LAS	2	10
page 100	GET_LDS	46 ₁₆	Get_LDS	2	10
page 101	GET_LPF	3E ₁₆	Get_LPF	2	10
page 101	GET_LOS	61 ₁₆	GET_LOS	2	10
page 102	SET_LOS	62 ₁₆	SET_LOS	10	2
page 103	GET_TECA	63 ₁₆	Get transm.err.counters	2	34
page 104	GET_TECB	64 ₁₆	Get transm.err.counters	2	34
page 104	GET_TEC_X	66 ₁₆	Get transm.err.counters	4	≥3
page 105	READ_FAULT_DETECTOR	10 ₁₆	Read Fault Detector	2	4
page 106	READ_DUPLICATE_ADDR	11 ₁₆	Read List of Duplicate Addresses	2	10
page 107	Configuration of AS-i Master				
page 107	SET_OP_MODE	0C ₁₆	Set_Operation_Mode	3	2
page 108	STORE_CDI	07 ₁₆	Store_Actual_Configuration	2	2

Issue date - 20.4.2007

Values for command

<i>see page</i>	Command	Value	Meaning	Req Len	Res Len
<i>page 108</i>	READ_CDI	28 ₁₆	Read_Actual_Configuration	3	4
<i>page 109</i>	SET_PCD	25 ₁₆	Set_Permanent_Config	5	2
<i>page 109</i>	GET_PCD	26 ₁₆	Get_Permanent_Config	3	4
<i>page 110</i>	SET_LPS	29 ₁₆	SET_LPS	11	2
<i>page 111</i>	GET_LPS	44 ₁₆	Get_LPS	2	10
<i>page 112</i>	STORE_PI	04 ₁₆	Store_Actual_Parameter	2	2
<i>page 112</i>	WRITE_P	02 ₁₆	Write_Parameter	4	3
<i>page 113</i>	READ_PI	03 ₁₆	Read_Parameter	3	3
<i>page 113</i>	SET_PP	43 ₁₆	Set_Permanent_Parameter	4	2
<i>page 114</i>	GET_PP	01 ₁₆	Get_Permanent_Parameter	3	3
<i>page 114</i>	SET_AAE	0B ₁₆	Set_Auto_Address_Enable	3	2
<i>page 117</i>	SLAVE_ADDR	0D ₁₆	Change_Slave_Address	4	2
<i>page 116</i>	WRITE_XID1	3F ₁₆	Write_Extended_ID-Code_1	3	2
<i>page 116</i>	Other commands				
<i>page 117</i>	IDLE	00 ₁₆	No request	2	2
<i>page 117</i>	READ_IDI	41 ₁₆	Read IDI	2	36
<i>page 118</i>	WRITE_ODI	42 ₁₆	Write ODI	34	2
<i>page 118</i>	READ_ODI	56 ₁₆	Read ODI	2	34
<i>page 119</i>	SET_OFFLINE	0A ₁₆	Set_Off-Line_Mode	3	2
<i>page 120</i>	SET_DATA_EX	48 ₁₆	Set_Data_Exchange_Active	3	2
<i>page 120</i>	BUTTONS	75 ₁₆	Disable Pushbuttons	3	2
<i>page 120</i>	FP_PARAM	7D ₁₆	„Functional Profile“ Param.	≥3	≥2
<i>page 121</i>	FP_DATA	7E ₁₆	„Functional Profile“ Data	≥3	≥2
<i>page 122</i>	INVERTER	7C ₁₆	Configure Inverter Slaves	12	4
<i>page 122</i>	MB_OP_CTRL_WR_FLAGS	0x85	Write Flags	≥5	2
<i>page 123</i>	MB_OP_CTRL_RD_FLAGS	0x86	Read Flags	4	≥3
<i>page 123</i>	RD_MFK_PARAM	0x59	Read SEW MFK21 Parameter	6	≥3

11.2.1 Values for results

	<i>Value</i>	<i>Place</i>	<i>Meaning</i>
OK	00 ₁₆	–	execution without fault
HI_NG	11 ₁₆	HI	general fault
HI_OPCODE	12 ₁₆	HI	illegal value in command
HI_LENGTH	13 ₁₆	HI	length of the command interface is too short
HI_ACCESS	14 ₁₆	HI	no access right
EC_NG	21 ₁₆	EC	general fault"
EC_SND	22 ₁₆	EC	slave (source addr) not detected
EC_SD0	23 ₁₆	EC	slave 0 detected
EC_SD2	24 ₁₆	EC	slave (target addr) not detected
EC_DE	25 ₁₆	EC	delete error
EC_SE	26 ₁₆	EC	set error
EC_AT	27 ₁₆	EC	address temporary
EC_ET	28 ₁₆	EC	extended ID1 temporary
EC_RE	29 ₁₆	EC	read (extended ID1) error

11.3 Commands of the Command Interface

11.3.1 AS-i 16-bit data

11.3.1.1 Overview of the commands

Values for command

<i>see page</i>	<i>Command</i>	<i>Value</i>	<i>Meaning</i>	<i>Req Len</i>	<i>Res Len</i>
<i>page 84</i>	RD_7X_IN	50 ₁₆	Read 1 16-bit slave profile in.data	3	10
<i>page 85</i>	WR_7X_OUT	51 ₁₆	Write 1 16-bit slave profile out.data	11	2
<i>page 85</i>	RD_7X_OUT	52 ₁₆	Read 1 16-bit slave profile out.data	3	10
<i>page 86</i>	RD_7X_IN_X	53 ₁₆	Read 4 16-bit slave profile in.data	3	34
<i>page 86</i>	WR_7X_OUT_X	54 ₁₆	Write 4 16-bit slave profile out.data	35	2
<i>page 87</i>	RD_7X_OUT_X	55 ₁₆	Read 4 16-bit slave profile out.data	3	34
<i>page 87</i>	OP_RD_16BIT_IN_CX	4C ₁₆	Read 16 channels 16-bit slave in.data	3	34
<i>page 88</i>	OP_WR_16BIT_IN_CX	4D ₁₆	Write 16 channels 16-bit slave in.data	36	2

11.3.1.2 Read 1 16-bit Slave in.Data (RD_7X_IN)

With this command, the four 16 bit channels of an AS-i input slave according to the slave profile (S-7.3, S-7.4, S-7.5, S-7.A.8, S.A.9, S-7.A.A) can be read.

 Note	<p>A-Slaves map the data on channels 1 and 2. B-Slaves map the data on channels 3 and 4. Only values among 1 and 31 can be taken as a slave address.</p>
--	--

Issue date - 20.4.2007

Request								
byte	2 ⁷	2 ⁶	2 ⁵	2 ⁴	2 ³	2 ²	2 ¹	2 ⁰
1	50 ₁₆							
2	T	–	circuit					
3	–		0	slave address				
Response								
byte	2 ⁷	2 ⁶	2 ⁵	2 ⁴	2 ³	2 ²	2 ¹	2 ⁰
1	50 ₁₆							
2	T	result						
3	channel 1, high byte							
...	...							
10	channel 4, low byte							

11.3.1.3 Write 1 16-bit Slave out.Data (WR_7X_OUT)

With this command, the four 16 bit channels of an AS-i output slave according to the slave profile (S-7.3, S-7.4, S-7.5, S-7.A.8, S.A.9, S-7.A.A) can be written.

Request								
byte	2 ⁷	2 ⁶	2 ⁵	2 ⁴	2 ³	2 ²	2 ¹	2 ⁰
1	51 ₁₆							
2	T	–	circuit					
3	–		0	slave address				
4	channel 1, high byte							
...	...							
11	channel 4, low byte							
Response								
byte	2 ⁷	2 ⁶	2 ⁵	2 ⁴	2 ³	2 ²	2 ¹	2 ⁰
1	51 ₁₆							
2	T	result						

11.3.1.4 Read 1 16-bit Slave out.Data (RD_7X_OUT)

With this command, the four 16 bit channels of an AS-i output slave according to the slave profile (S-7.3, S-7.4, S-7.5, S-7.A.8, S.A.9, S-7.A.A) can be read out of the AS-i/DeviceNet Gateway.

Request								
byte	2 ⁷	2 ⁶	2 ⁵	2 ⁴	2 ³	2 ²	2 ¹	2 ⁰
1	52 ₁₆							
2	T	–	circuit					
3	–		0	slave address				

Response								
byte	2^7	2^6	2^5	2^4	2^3	2^2	2^1	2^0
1	52_{16}							
2	T	result						
3	channel 1, high byte							
...	...							
10	channel 4, low byte							

11.3.1.5 Read 4 16-bit Slave in.Data (RD_7X_IN_X)

With this command, the four 16-bit channels of 4 AS-i input slaves with successive addresses according to slave profile (S-7.3, S-7.4, S-7.5, S-7.A.8, S.A.9, S-7.A.A) can be read.

Request								
byte	2^7	2^6	2^5	2^4	2^3	2^2	2^1	2^0
1	53_{16}							
2	T	-	circuit					
3	-		0	1st slave address				

Response								
byte	2^7	2^6	2^5	2^4	2^3	2^2	2^1	2^0
1	53_{16}							
2	T	result						
3	1st slave, channel 1, high byte							
...	...							
34	4th slave, channel 4, low byte							

11.3.1.6 Write 4 7.3 Slave out.Data (WR_7X_OUT_X)

With this command the four 16-bit channels of four AS-i output slaves with successive addresses according to slave profile (S-7.3, S-7.4, S-7.5, S-7.A.8, S.A.9, S-7.A.A) can be written.

Request								
byte	2^7	2^6	2^5	2^4	2^3	2^2	2^1	2^0
1	54_{16}							
2	T	-	circuit					
3	-		0	1st slave address				
4	1st slave, channel 1, high byte							
...	...							
35	4th slave, channel 4, low byte							

Issue date - 20.4.2007

Response								
byte	2 ⁷	2 ⁶	2 ⁵	2 ⁴	2 ³	2 ²	2 ¹	2 ⁰
1	54 ₁₆							
2	T	result						

11.3.1.7 Read 4 7.3 Slave out.Data (RD_7X_OUT_X)

With this command, the four 16-bit channels of four AS-i output slaves with successive addresses according to slave profile (S-7.3, S-7.4, S-7.5, S-7.A.8, S.A.9, S-7.A.A) can be read.

Request								
byte	2 ⁷	2 ⁶	2 ⁵	2 ⁴	2 ³	2 ²	2 ¹	2 ⁰
1	55 ₁₆							
2	T	–	circuit					
3	–		0	1st slave address				

Response								
byte	2 ⁷	2 ⁶	2 ⁵	2 ⁴	2 ³	2 ²	2 ¹	2 ⁰
1	55 ₁₆							
2	T	result						
3	1st slave, channel 1, high byte							
...	...							
34	4th slave, channel 4, low byte							

11.3.1.8 Read 16 channels 16-bit Slave in.Data (OP_RD_16BIT_IN_CX)

With this command, the 16 channels of the 16-bit input-data for slaves with successive addresses according to slave profile (S-7.3, S-7.4, S-7.5, S-7.A.8, S.A.9, S-7.A.A) can be read

Request								
Byte	2 ⁷	2 ⁶	2 ⁵	2 ⁴	2 ³	2 ²	2 ¹	2 ⁰
1	4C ₁₆							
2	T	–	circuit					
3	1. slave							
4	1. channel							

Response								
Byte	2^7	2^6	2^5	2^4	2^3	2^2	2^1	2^0
1	4C ₁₆							
2	T	result						
3	1. slave, channel 1, high byte							
4	1. slave, channel 1, low byte							
...	...							
33	16. channel, high byte							
34	16. channel, low byte							

11.3.1.9 Write 16 channels 16-bit slave out.Data (OP_WR_16BIT_IN_CX)

With this command, the 16 channels of the 16-bit input-data for slaves with successive addresses according to slave profile (S-7.3, S-7.4, S-7.5, S-7.A.8, S.A.9, S-7.A.A) can be written.

Request								
Byte	2^7	2^6	2^5	2^4	2^3	2^2	2^1	2^0
1	4D ₁₆							
2	T	circuit						
3	1. slave							
4	1. channel							
5	1. slave, 1. channel, high byte							
6	1. slave, 1. channel, low byte							
...	...							
35	16. channel, high byte							
36	16. channel, low byte							

Response								
Byte	2^7	2^6	2^5	2^4	2^3	2^2	2^1	2^0
1	4D ₁₆							
2	T	result						

11.3.2 Commands acc. to Profile S-7.4/S-7.5

11.3.2.1 Overview of the commands

Values for command

see page	Command	Value	Meaning	Req Len	Res Len
page 89	WR_74_75_PARAM	5A ₁₆	Write S-7.4/S-7.5-slave parameter	≥6	2
page 90	RD_74_75_PARAM	5B ₁₆	Read S-7.4/S-7.5-slave parameter	4	≥3
page 91	RD_74_75_ID	5C ₁₆	Read S-7.4/S-7.5-slave ID string	4	≥3
page 91	RD_74_DIAG	5D ₁₆	Read S-7.4/S-7.5-slave diagnosis string	4	≥3

11.3.2.2 WR_74_75_PARAM

Description:

- with this function the parameter string of a slave according to profile S-7.4 is being written

or

- the data transfer with a slave according to profile S-7.5 is started.

If it is about a slave according to profile 7.5, data have to be registered into the buffer in the same form, as they have to be sent by AS-i.

Since the string can be longer than the command interface, it will partly be written into the buffer and then be transferred to the slave.

n is the length of the part of the string which should be written into the buffer from index i on.

If $i \equiv 0$, then the string is being transferred to the slave.

Request								
byte	2 ⁷	2 ⁶	2 ⁵	2 ⁴	2 ³	2 ²	2 ¹	2 ⁰
1	5A ₁₆							
2	T	–	circuit					
3	slave address							
4	i							
5	n							
6	buffer byte i							
...	...							
n+5	buffer byte i+n-1							

Response								
byte	2 ⁷	2 ⁶	2 ⁵	2 ⁴	2 ³	2 ²	2 ¹	2 ⁰
1	5A ₁₆							
2	T	results						

11.3.2.3 RD_74_75_PARAM

Description:

- with this function the parameter string of a slave according to profile S-7.4 is being read

or

- the slave response according to profile S-7.5 is being read.

If it is about a slave according to profile 7.5, so have the data in the response buffer the following meaning:

FFh 00h: Transfer is still active

FFh xxh: Transfer finished with error

The first byte in the buffer not equal FFH: slave response. The response is in the same form registered in the buffer and transmitted over AS-i.

Since the string can be longer than the command interface, it is written into the buffer. The content of the buffer can read in parts from index i.

The first byte of the buffer is the length of the read string.

If $i \equiv 0$, the string is being read from the slave, otherwise the function responses out of the memory; the data can be read consistently.

Request								
byte	2^7	2^6	2^5	2^4	2^3	2^2	2^1	2^0
1	$5B_{16}$							
2	T	-	circuit					
3	slave address							
4	i							

Response								
byte	2^7	2^6	2^5	2^4	2^3	2^2	2^1	2^0
1	$5B_{16}$							
2	T	result						
3	buffer byte i							
...	...							
n+2	buffer byte i+n-1							

11.3.2.4 RD_74_75_ID

With this function the ID string of a slave according to profile S-7.4 or the 16-bit slave configuration according to profile 7.5 is being read. Since the string can be longer than the command interface, it is written into the buffer. The content of the buffer can read in parts from index i .

The first byte of the buffer is the length of the read string.

If $i \equiv 0$, the string is being read from the slave, otherwise the function responses out of the memory, the data can be read consistently.

Request								
byte	2^7	2^6	2^5	2^4	2^3	2^2	2^1	2^0
1	$5C_{16}$							
2	T	–	circuit					
3	slave address							
4	i							

Response								
byte	2^7	2^6	2^5	2^4	2^3	2^2	2^1	2^0
1	$5C_{16}$							
2	T	result						
3	buffer byte i							
...	...							
$n+2$	buffer byte $i+n-1$							

By a 7.5 slave is the request always 1. The response byte contains the cyclic 16-bit slave configuration according to S-7.5 profile (analog/transparent bits are cancelled). If the response is 08h, that means that the cyclic 16-bit configuration could not be detected.

11.3.2.5 RD_74_DIAG

With this function the diagnosis string of a slave according to profile S-7.4 is being read. Since the string can be longer than the command interface, it is written into the buffer. The content of the buffer can be read in parts from index i .

The first byte of the buffer indicates the length of the read string.

If $i \equiv 0$, the string is being read from the slave, otherwise the function responses out of the memory, the data can be read consistently.

Request								
byte	2^7	2^6	2^5	2^4	2^3	2^2	2^1	2^0
1	$5D_{16}$							
2	T	–	circuit					
3	slave address							
4	i							

Response								
byte	2^7	2^6	2^5	2^4	2^3	2^2	2^1	2^0
1	5D ₁₆							
2	T	result						
3	buffer byte i							
...	...							
n+2	buffer byte i+n-1							

11.3.3 Acyclic commands

11.3.3.1 Overview of the commands

Values for command

see page	Command	Value	Meaning	Req Len	Res Len
page 92	WRITE_ACYC_TRANS	4E ₁₆	Write acyclic transfer	≥7	2
page 94	READ_ACYC_TRANS	4F ₁₆	Read acyclic transfer	5	≥2

11.3.3.2 WRITE_ACYCLIC_TRANS

This function activates different arts of acyclic transfer (S-7.4, S-7.5 and safety monitor). The results have to be read out with READ_ACYCLIC_TRANS. Even though this function runs in the background and doesnt hold the master during the transmission, it ist intended to act as a substitute for (RD_74_75_PARAM, WR_74_75_PARAM, RD_74_75_ID, RD_74_DIAG and „Safety at Work“- monitor diagnnestic).

Since the transferred data can be longer than the command interface, it is written into the buffer. The content of the buffer can be read in parts from index.

n is the length of the part string, that (from Index (i)) should be written in the buffer. The transmission proceeds, if i=0.

Request								
Byte	2^7	2^6	2^5	2^4	2^3	2^2	2^1	2^0
1	4Eh							
2	circuit							
3	slave							
4	buffer Index (i) high							
5	buffer Index (i) low							
6	command ¹							
7	number of(n)							
8	data							
...	...							
x	data+n							

Issue date - 20.4.2007

1. Following commands are supported:
 - 1: S-7.4 ID string Read (no sent data required).
 - 2: S-7.4 Diag String Read (no sent data required).
 - 3: S-7.4 Param String Read (no sent data required).
 - 4: S-7.4 Param String Write (buffer contains sent string).
 - 5: S-7.5 Transfer. Buffer contains sent string in the same form, as the telegram, that have to be sent over AS-i.
 - 6: S-7.5 Cyclic 16-Bit Slave Configuration Read (analog/transparent bits are cancelled in the response). The cyclic 16-bit configuration cannot be detected, if the response is 08h.
 - 7: Safety Monitor sorted Read (no sent data required).
 - 8: Safety Monitor unsorted (all devices) Read (no sent data required).

 Note	Please view <chapter 11.4.2 Monitor Diagnosis> for further information.
--	---

Response								
Byte	2^7	2^6	2^5	2^4	2^3	2^2	2^1	2^0
1	$4E_{16}$							
2	response							

11.3.3.3 READ_ACYCLIC_TRANS

With this call the response of the transfer command (started with WRITE_ACYCLIC_TRANS) is read out.

The first byte in the response buffer indicates the current command.

FF₁₆ means transfer still active, FE₁₆ means transfer interrupted with errors.

The both following bytes (high,low) set the length of the response buffer.

It is always recommended to read the data starting with the index $i = 0$.

Request								
Byte	2 ⁷	2 ⁶	2 ⁵	2 ⁴	2 ³	2 ²	2 ¹	2 ⁰
1	4F ₁₆							
2	circuit							
3	slave							
4	buffer index (i) high							
5	buffer index (i) low							

Response								
Byte	2 ⁷	2 ⁶	2 ⁵	2 ⁴	2 ³	2 ²	2 ¹	2 ⁰
1	4F ₁₆							
2	response							
3	data							
...	...							
x	data+n							

The response data have the same format, as by commands RD_74_75_PARAM, RD_74_75_ID and „safety at work“-monitor diagnostics.

11.3.4 AS-i Diagnosis

11.3.4.1 Overview of the commands

Values for command

see page	Command	Value	Meaning	Req Len	Res Len
page 95	GET_LISTS	30 ₁₆	Get LDS, LAS, LPS, Flags	2	29
page 97	GET_FLAGS	47 ₁₆	Get_Flags	2	5
page 98	GET_DELTA	57 ₁₆	Get list of config. diff.	2	10
page 99	GET_LCS	60 ₁₆	Get LCS	2	10
page 99	GET_LAS	45 ₁₆	Get_LAS	2	10
page 100	GET_LDS	46 ₁₆	Get_LDS	2	10
page 101	GET_LPF	3E ₁₆	Get_LPF	2	10
page 101	GET_LOS	61 ₁₆	GET_LOS	2	10
page 102	SET_LOS	62 ₁₆	SET_LOS	10	2
page 103	GET_TECA	63 ₁₆	Get transm.err.counters	2	34
page 104	GET_TECB	64 ₁₆	Get transm.err.counters	2	34
page 104	GET_TEC_X	66 ₁₆	Get transm.err.counters	4	≥3
page 105	READ_FAULT_DETECTOR	10 ₁₆	Read Fault Detector	2	4
page 106	READ_DUPLICATE_ADDR	11 ₁₆	Read List of Duplicate Addresses	2	10

11.3.4.2 Get Lists and Flags (Get_LPS, Get_LAS, Get_LDS, Get_Flags) (GET_LISTS)

With this call, the following entries are read out of the AS-i/DeviceNet Gateway:

- The list of active AS-i slaves (LAS)
- The list of detected AS-i slaves (LDS)
- The list of projected AS-i slaves (LPS)
- The flags according to the AS-i slave specification

Request								
byte	2 ⁷	2 ⁶	2 ⁵	2 ⁴	2 ³	2 ²	2 ¹	2 ⁰
1	30 ₁₆							
2	T	O	circuit					

Response (if O ≡ 0)								
byte	2 ⁷	2 ⁶	2 ⁵	2 ⁴	2 ³	2 ²	2 ¹	2 ⁰
1	30 ₁₆							
2	T	result						
3	7A	6A	5A	4A	3A	2A	1A	0A
...	LAS							
10	31B	30B	29B	28B	27B	26B	25B	24B
11	7A	6A	5A	4A	3A	2A	1A	0A
...	LDS							
18	31B	30B	29B	28B	27B	26B	25B	24B
19	7A	6A	5A	4A	3A	2A	1A	0A
...	LPS							
26	31B	30B	29B	28B	27B	26B	25B	24B
27	-							Pok
28	OR	APF	NA	CA	AAv	AAs	S0	Cok
29	-					AAe	OL	DX

Response (if O ≡ 1)								
byte	2 ⁷	2 ⁶	2 ⁵	2 ⁴	2 ³	2 ²	2 ¹	2 ⁰
1	30 ₁₆							
2	T	result						
3	0A	1A	2A	3A	4A	5A	6A	7A
...	LAS							
10	24B	25B	26B	27B	28B	29B	30B	31B
11	0A	1A	2A	3A	4A	5A	6A	7A
...	LDS							
18	24B	25B	26B	27B	28B	29B	30B	31B
19	0A	1A	2A	3A	4A	5A	6A	7A
...	LPS							
26	24B	25B	26B	27B	28B	29B	30B	31B
27	-							Pok
28	OR	APF	NA	CA	AAv	AAs	S0	Cok
29	-					AAe	OL	DX

Pok Periphery_Ok
 S0 LDS.0
 AAs Auto_Address_Assign
 AAv Auto_Address_Available
 CA Configuration_Active
 NA Normal_Operation_Active
 APF APF
 OR Offline_Ready

Issue date - 20.4.2007

Cok Config_Ok
 AAe Auto_Address_Enable
 OL Offline
 DX Data_Exchange_Active

11.3.4.3 Get Flags (GET_FLAGS)

With this call, the following entry is read out of the AS-i/DeviceNet Gateway: the flags according to the AS-i slave specification.

Request								
byte	2 ⁷	2 ⁶	2 ⁵	2 ⁴	2 ³	2 ²	2 ¹	2 ⁰
1	47 ₁₆							
2	T	-	circuit					
Response								
byte	2 ⁷	2 ⁶	2 ⁵	2 ⁴	2 ³	2 ²	2 ¹	2 ⁰
1	47 ₁₆							
2	T	response						
3								Pok
4	OR	APF	NA	CA	AAv	AAe	S0	Cok
5	-					AAe	OL	DX

- Pok Periphery_Ok
This flag is set when no AS-i slave is signaling a peripheral fault.
- S0 LDS.0
This flag is set when an AS-i slave with address 0 exists.
- AAe Auto_Address_Assign
This flag is being set when the automatic address programming is possible (in other words, AUTO_ADDR_ENABLE = 1; no "incorrect" slave connected to the AS-i).
- AAv Auto_Address_Available
This flag is set when the automatic address programming can be executed, exactly one AS-i slave is currently out of operation.
- CA Configuration_Active
The flag is set in configuration mode and reset in protected mode.
- NA Normal_Operation_Active
This flag is set when the AS-i master is in normal operation.
- APF AS-i Power Fail
This flag is set when the voltage on the AS-i cable is too low.
- OR Offline_Ready
The flag is set when the offline phase is active.

Cok Config_Ok

This flag is set when the desired (configured) and actual configuration match.

AAe Auto_Address_Enable

This flag indicates whether the automatic address programming is enabled (bit = 1) or disabled (bit = 0) by the user.

OL Offline

This flag is set when the mode should be changed to OFFLINE or when this mode has already been reached.

DX Data_Exchange_Active

If the "Data_Exchange_Active" flag is set, the data exchange between AS-i master and slaves is available in the data exchange phase. If this bit is not set the data exchange is not available. The read ID telegrams are transmitted to the slave.

The bit is set if the AS-i master enters the offline phase.

11.3.4.4 Get Delta List (GET_DELTA)

The delta list contains the list of slave addresses with configuration errors.

Request								
byte	2^7	2^6	2^5	2^4	2^3	2^2	2^1	2^0
1	57_{16}							
2	T	0	circuit					

Response (if O ≡ 0)								
byte	2^7	2^6	2^5	2^4	2^3	2^2	2^1	2^0
1	57_{16}							
2	T	result						
3	7A	6A	5A	4A	3A	2A	1A	–
...	...							
10	31B	30B	29B	28B	27B	26B	25B	24B

Response (if O ≡ 1)								
byte	2^7	2^6	2^5	2^4	2^3	2^2	2^1	2^0
1	57_{16}							
2	T	result						
3	0	1A	2A	3A	4A	5A	6A	7A
...	...							
10	24B	25B	26B	27B	28B	29B	30B	31B

11.3.4.5 Get list of corrupted Slaves (GET_LCS and GET_LCS_R6 (6CH))

The call GET_LCS_R6 (6CH) differs to the call GET_LCS in the half long LCS list. With the bit 2^5 is selected if the upper (=1) or lower (=0) part of the LCS is read. Read first with 2^5 in order to create a local copy of the LCS. Reading with bit $2^5=1$ transmits the upper part of the copy.

With the call GET_LCS, the List of Corrupted Slaves (LCS) is read out of the AS-i/DeviceNet Gateway.

Request								
byte	2^7	2^6	2^5	2^4	2^3	2^2	2^1	2^0
1	60_{16}							
2	T	O	circuit					

Response (if $O \equiv 0$)								
byte	2^7	2^6	2^5	2^4	2^3	2^2	2^1	2^0
1	60_{16}							
2	T	result						
3	7A	6A	5A	4A	3A	2A	1A	0A
...	...							
10	31B	30B	29B	28B	27B	26B	25B	24B

Response (if $O \equiv 1$)								
byte	2^7	2^6	2^5	2^4	2^3	2^2	2^1	2^0
1	60_{16}							
2	T	result						
3	0A	1A	2A	3A	4A	5A	6A	7A
...	...							
10	24B	25B	26B	27B	28B	29B	30B	31B

11.3.4.6 Get list of activated Slaves (GET_LAS)

With this call, the following entry is read out of the AS-i/DeviceNet Gateway: The list of activated slaves (LAS).

Request								
byte	2^7	2^6	2^5	2^4	2^3	2^2	2^1	2^0
1	45_{16}							
2	T	O	circuit					

Response (if O ≡ 0)								
byte	2 ⁷	2 ⁶	2 ⁵	2 ⁴	2 ³	2 ²	2 ¹	2 ⁰
1	45 ₁₆							
2	T	result						
3	7A	6A	5A	4A	3A	2A	1A	0A
...	...							
10	31B	30B	29B	28B	27B	26B	25B	24B

Response (if O ≡ 1)								
byte	2 ⁷	2 ⁶	2 ⁵	2 ⁴	2 ³	2 ²	2 ¹	2 ⁰
1	45 ₁₆							
2	T	result						
3	0A	1A	2A	3A	4A	5A	6A	7A
...	...							
10	24B	25B	26B	27B	28B	29B	30B	31B

11.3.4.7 Get list of detected AS-i Slaves (GET_LDS)

With this call, the following entry is read out of the AS-i/DeviceNet Gateway: The list of detected AS-i slaves (*LDS*).

Request								
byte	2 ⁷	2 ⁶	2 ⁵	2 ⁴	2 ³	2 ²	2 ¹	2 ⁰
1	46 ₁₆							
2	T	O	circuit					

Response (if O ≡ 0)								
byte	2 ⁷	2 ⁶	2 ⁵	2 ⁴	2 ³	2 ²	2 ¹	2 ⁰
1	46 ₁₆							
2	T	result						
3	7A	6A	5A	4A	3A	2A	1A	0A
...	...							
10	31B	30B	29B	28B	27B	26B	25B	24B

Response (if O ≡ 1)								
byte	2 ⁷	2 ⁶	2 ⁵	2 ⁴	2 ³	2 ²	2 ¹	2 ⁰
1	46 ₁₆							
2	T	result						
3	0A	1A	2A	3A	4A	5A	6A	7A
...	...							
10	24B	25B	26B	27B	28B	29B	30B	31B

Issue date - 20.4.2007

11.3.4.8 Get list of peripheral faults (GET_LPF)

With this call, the list of peripheral faults (*LPF*) signaled by the AS-i slaves is read out from the AS-i master. The LPF is updated cyclically by the AS-i master. If and when an AS-i slave signals faults of the attached peripherals (for example broken wire) can be found in the description of the AS-i slave.

Request								
byte	2 ⁷	2 ⁶	2 ⁵	2 ⁴	2 ³	2 ²	2 ¹	2 ⁰
1	3E ₁₆							
2	T	O	circuit					

Response (if O ≡ 0)								
byte	2 ⁷	2 ⁶	2 ⁵	2 ⁴	2 ³	2 ²	2 ¹	2 ⁰
1	3E ₁₆							
2	T	result						
3	7A	6A	5A	4A	3A	2A	1A	0A
...	...							
10	31B	30B	29B	28B	27B	26B	25B	24B

Response (if O ≡ 1)								
byte	2 ⁷	2 ⁶	2 ⁵	2 ⁴	2 ³	2 ²	2 ¹	2 ⁰
1	3E ₁₆							
2	T	result						
3	0A	1A	2A	3A	4A	5A	6A	7A
...	...							
10	24B	25B	26B	27B	28B	29B	30B	31B

11.3.4.9 Get list of offline Slaves (GET_LOS)

With this call, the list of slaves causing the offline phase when a configuration error occurs in being read out (List of Offline Slaves, *LOS*).

The user can choose the reaction of the master when a configuration error occurs. The master can be switched off line when an important slave causes a configuration error; less important slaves can send an error to the host, AS-i however will not be switched offline.

Request								
byte	2^7	2^6	2^5	2^4	2^3	2^2	2^1	2^0
1	61_{16}							
2	T	O	circuit					

Response (if O = 0)								
byte	2^7	2^6	2^5	2^4	2^3	2^2	2^1	2^0
1	61_{16}							
2	T	result						
3	7A	6A	5A	4A	3A	2A	1A	0A
...	...							
10	31B	30B	29B	28B	27B	26B	25B	24B

Response (if O = 1)								
byte	2^7	2^6	2^5	2^4	2^3	2^2	2^1	2^0
1	61_{16}							
2	T	result						
3	0A	1A	2A	3A	4A	5A	6A	7A
...	...							
10	24B	25B	26B	27B	28B	29B	30B	31B

11.3.4.10 Set list of offline Slaves (SET_LOS and SET_LOS_R6 (6Dh))

The call **SET_LOS_R6 (6D₁₆)** differs to the call GET_LOS in the half long LOS list.

With the bit 2^5 is selected if the upper (=1) or lower (=0) part of the LOS is written.

With this call, the list of slaves causing the offline phase when a configuration error occurs in being defined (List of Offline Slaves, LOS).

The user can choose the reaction of the master when a configuration error occurs. The master can be switched offline when an important slave causes a configuration error; less important slaves can send an error to the host, AS-i however will not be switched offline.

Request (if O = 0)								
byte	2^7	2^6	2^5	2^4	2^3	2^2	2^1	2^0
1	62_{16}							
2	T	O	circuit					
3	7A	6A	5A	4A	3A	2A	1A	0A
...	...							
10	31B	30B	29B	28B	27B	26B	25B	24B

Issue date - 20.4.2007

Request (if O ≡ 1)								
byte	2 ⁷	2 ⁶	2 ⁵	2 ⁴	2 ³	2 ²	2 ¹	2 ⁰
1	62 ₁₆							
2	T	1	circuit					
3	0A	1A	2A	3A	4A	5A	6A	7A
...	...							
10	24B	25B	26B	27B	28B	29B	30B	31B

Response								
byte	2 ⁷	2 ⁶	2 ⁵	2 ⁴	2 ³	2 ²	2 ¹	2 ⁰
1	62 ₁₆							
2	T	result						

11.3.4.11 Get transm.err.counters (GET_TECA)

 Note	In order to get the real number of transcription errors, multiply the value with 2
--	--

With this call the error counters of all single slaves/A-slaves can be read (see chapter 9).

With every reading out of the counts, the error counters will be restarted.

The counts are being read out via the corresponding host interface and will be deleted with every read access. The counter's value is limited to 254. 255 will cause a counter overflow.

The counts could be independent of the counters, which are displayed in the display of the gateway.

Request								
byte	2 ⁷	2 ⁶	2 ⁵	2 ⁴	2 ³	2 ²	2 ¹	2 ⁰
1	63 ₁₆							
2	T	-	circuit					

Response								
byte	2 ⁷	2 ⁶	2 ⁵	2 ⁴	2 ³	2 ²	2 ¹	2 ⁰
1	63 ₁₆							
2	T	result						
3	APF							
4	slave 1A							
...	...							
34	slave 31A							

11.3.4.12 Get transm.err.counters (GET_TECB)

 Note	In order to get the real number of transcription errors, multiply the value with 2
--	--

With this call, the counts of the error counters for B-slaves are being read out (see chapter 9).

With every reading out of the counts, the error counters will be restarted.

The counts are being read out via the corresponding host interface and will be deleted with every read access. The counter's value is limited to 254. 255 will cause a counter overflow.

The counts could be independent of the counters, which are displayed in the display of the gateway.

Request								
byte	2^7	2^6	2^5	2^4	2^3	2^2	2^1	2^0
1	64_{16}							
2	T	-	circuit					

Response								
byte	2^7	2^6	2^5	2^4	2^3	2^2	2^1	2^0
1	64_{16}							
2	T	result						
3	APF							
4	slave 1B							
...	...							
34	slave 31B							

11.3.4.13 Get transm.err.counters (GET_TEC_X)

Beginning with a definite slave address, the counts of the n error counters are being read out with this call.

With every reading out the counts, the error counters will be restarted.

The counts are being read out via the corresponding host interface and will be deleted with every read access. The counter's value is limited to 254. 255 will cause a counter overflow.

The counts could be independent of the counters, which are displayed in the display of the gateway.

Request								
byte	2 ⁷	2 ⁶	2 ⁵	2 ⁴	2 ³	2 ²	2 ¹	2 ⁰
1	66 ₁₆							
2	T	–	circuit					
3	1. slave address							
4	number of counters							

Response								
byte	2 ⁷	2 ⁶	2 ⁵	2 ⁴	2 ³	2 ²	2 ¹	2 ⁰
1	66 ₁₆							
2	T	result						
3	counter 1							
...	...							
n	counter n - 2							

11.3.4.14 Read fault detector (READ_FAULT_DETECTOR)

With this call all informations of the AS-i detector are read out. In the first byte are stored the values transferred in the moment, in the second all values since the last deleting. By it it is possible to recognize immediate, no more existing before messages also. The second byte is deleted by reading.

Request								
byte	2 ⁷	2 ⁶	2 ⁵	2 ⁴	2 ³	2 ²	2 ¹	2 ⁰
1	10 ₁₆							
2	T	–	circuit					

Response								
byte	2 ⁷	2 ⁶	2 ⁵	2 ⁴	2 ³	2 ²	2 ¹	2 ⁰
1	10 ₁₆							
2	T	result						
3	DA	ST	US	ES	24 V	reserved		
4	DA	ST	US	ES	24 V	reserved		

DA duplicate address

ST noise

US over voltage

ES earth fault

24 V failure of the redundant 24V

11.3.4.15 Read list of duplicate addresses (READ_DUPLICATE_ADDR)

With this call the list of slaves with duplicate addresses (the assignment of one address to two slaves) is read out.

Request								
byte	2^7	2^6	2^5	2^4	2^3	2^2	2^1	2^0
1	11_{16}							
2	T	O	circuit					

Response (if O ≡ 0)								
byte	2^7	2^6	2^5	2^4	2^3	2^2	2^1	2^0
1	11_{16}							
2	T	result						
3	7A	6A	5A	4A	3A	2A	1A	0A
...	...							
10	31B	30B	29B	28B	27B	26B	25B	24B

Response (if O ≡ 1)								
byte	2^7	2^6	2^5	2^4	2^3	2^2	2^1	2^0
1	11_{16}							
2	T	result						
3	0A	1A	2A	3A	4A	5A	6A	7A
...	...							
10	24B	25B	26B	27B	28B	29B	30B	31B



Note

Further diagnosis functions for "Safety at Work" and for availability (resp. for warnings) of integrated sensors are detailed explained in the chapter "Functional profiles" (chapter 11.4).

11.3.5 Configuration of AS-i Master

11.3.5.1 Overview of the commands

Values for command

<i>see page</i>	<i>Command</i>	<i>Value</i>	<i>Meaning</i>	<i>Req Len</i>	<i>Res Len</i>
<i>page 107</i>	SET_OP_MODE	0C ₁₆	Set_Operation_Mode	3	2
<i>page 108</i>	STORE_CDI	07 ₁₆	Store_Actual_Configuration	2	2
<i>page 108</i>	READ_CDI	28 ₁₆	Read_Actual_Configuration	3	4
<i>page 109</i>	SET_PCD	25 ₁₆	Set_Permanent_Config	5	2
<i>page 109</i>	GET_PCD	26 ₁₆	Get_Permanent_Config	3	4
<i>page 110</i>	SET_LPS	29 ₁₆	SET_LPS	11	2
<i>page 111</i>	GET_LPS	44 ₁₆	Get_LPS	2	10
<i>page 112</i>	STORE_PI	04 ₁₆	Store_Actual_Parameter	2	2
<i>page 112</i>	WRITE_P	02 ₁₆	Write_Parameter	4	3
<i>page 113</i>	READ_PI	03 ₁₆	Read_Parameter	3	3
<i>page 113</i>	SET_PP	43 ₁₆	Set_Permanent_Parameter	4	2
<i>page 114</i>	GET_PP	01 ₁₆	Get_Permanent_Parameter	3	3
<i>page 114</i>	SET_AAE	0B ₁₆	Set_Auto_Address_Enable	3	2
<i>page 117</i>	SLAVE_ADDR	0D ₁₆	Change_Slave_Address	4	2
<i>page 116</i>	WRITE_XID1	3F ₁₆	Write_Extended_ID-Code_1	3	2

11.3.5.2 Set operation mode (SET_OP_MODE: Set_Operation_Mode)

This call switches between configuration mode and protected mode. In protected mode, only AS-i slaves entered in the LPS and whose expected and actual configurations match, are being activated.

In other words: The slaves are being activated if the I/O configuration and the ID codes of the detected AS-i slaves are identical to the configured values.

In configuration mode, all detected AS-i slaves (except for AS-i slave "0") are activated. This also applies to AS-i slaves for which there are differences between the expected and actual configuration.

The "OPERATION MODE" bit is stored permanently; in other words, it is retained after a cold/warm restart.

When you change from configuration mode to protected mode, the AS-i master will do a warm restart (change to the offline phase followed by a change to the online mode).



Note

If an AS-i slave with address "0" is entered in the LDS, the AS-i/DeviceNet gateway cannot change from configuration mode to protected mode.

Request								
byte	2 ⁷	2 ⁶	2 ⁵	2 ⁴	2 ³	2 ²	2 ¹	2 ⁰
1	0C ₁₆							
2	T	-	circuit					
3	operation mode							

Response								
byte	2 ⁷	2 ⁶	2 ⁵	2 ⁴	2 ³	2 ²	2 ¹	2 ⁰
1	0C ₁₆							
2	T	result						

Meaning of bit operation mode:

- 0 = protected mode
- 1 = configuration mode

11.3.5.3 Store actual configuration (STORE_CDI)

With this call, the (actual) configuration data (I/O configuration, ID code, extended ID1 code and extended ID2 code) of all AS-i slaves are stored permanently in the EEPROM as the (expected) configuration data. The list of activated AS-i slaves (*LAS*) is adopted in the list of permanent AS-i slaves (*LPS*).

When this command is executed, the AS-i master changes to the offline phase and then changes back to the normal mode (warm restart on the AS-i master).

This command can only be executed in the configuration mode.

Response								
byte	2 ⁷	2 ⁶	2 ⁵	2 ⁴	2 ³	2 ²	2 ¹	2 ⁰
1	07 ₁₆							
2	T	result						

11.3.5.4 Read actual configuration (READ_CDI)

With this call, the following configuration data of an addressed AS-i slave obtained by the AS-i master on the AS-Interface are read.

- I/O configuration
- ID code
- Extended ID1 code
- Extended ID2 code

The configuration data are specified by the manufacturer of the AS-i slave.

Request								
byte	2 ⁷	2 ⁶	2 ⁵	2 ⁴	2 ³	2 ²	2 ¹	2 ⁰
1	28 ₁₆							
2	T	-	circuit					
3	-		B	slave address				

Issue date - 20.4.2007

Response								
byte	2 ⁷	2 ⁶	2 ⁵	2 ⁴	2 ³	2 ²	2 ¹	2 ⁰
1	28 ₁₆							
2	T	result						
3	xID2				xID1			
4	ID				IO			

Meaning of bit B:

B = 0 Single AS-i slave or A-slave

B = 1 B-slave

11.3.5.5 Set permanent configuration (SET_PCD)

This call sets the following configuration data for the addressed AS-i slave:

- I/O configuration
- ID code
- Extended ID1 code
- Extended ID2 code

The configuration data are stored permanently on the EEPROM of the AS-i/DeviceNet gateway and are used as the expected configuration by the AS-i master in the protected mode. The configuration data are specified by the manufacturer of the AS-i slave.

If the addressed AS-i slave does not support an extended ID code 1/2, the value F_{hex} must be specified.

When this command is executed, the AS-i master changes to the offline phase and then changes back to the normal mode (warm restart).

This command can only be executed in the configuration mode.

Request								
byte	2 ⁷	2 ⁶	2 ⁵	2 ⁴	2 ³	2 ²	2 ¹	2 ⁰
1	25 ₁₆							
2	T	–	circuit					
3	–		B	slave address				
4	xID2				xID1			
5	ID				IO			

Response								
byte	2 ⁷	2 ⁶	2 ⁵	2 ⁴	2 ³	2 ²	2 ¹	2 ⁰
1	25 ₁₆							
2	T	result						

Meaning of bit B:

B = 0 Single AS-i slave or A-slave

B = 1 B-slave

11.3.5.6 Get extended permanent configuration (GET_PCD)

This call reads the following configuration data (configured data) of an addressed AS-i slave stored on the EEPROM of the AS-i master:

- I/O configuration
- ID code
- Extended ID1 code
- Extended ID2 code

The configuration data are specified by the manufacturer of the AS-i slave.

Request								
byte	2 ⁷	2 ⁶	2 ⁵	2 ⁴	2 ³	2 ²	2 ¹	2 ⁰
1	26 ₁₆							
2	T	–	circuit					
3	–		B	slave address				
Response								
byte	2 ⁷	2 ⁶	2 ⁵	2 ⁴	2 ³	2 ²	2 ¹	2 ⁰
1	26 ₁₆							
2	T	result						
3	xID2				xID1			
4	ID				IO			

Meaning of bit B:

- B = 0 Single AS-i slave or A-slave
- B = 1 B-slave

11.3.5.7 Set list of projected slaves (SET_LPS and SET_LPS_R6 (6Bh))

The command **SET_LPS_R6 (6Bh)** differs from the command **SET-LPS** in:

- no empty byte (3)
- half so long LPS list

With the bit 2⁵ is selected if the upper (=1) or lower (=0) part of the LCS is read.

With this call, the list of configured AS-i slaves is transferred for permanent storage in the EEPROM of the master.

When this command is executed, the AS-i master changes to the offline phase and then changes back to the normal mode (warm restart).

This command can only be executed in the configuration mode.

Request (if O ≡ 0)								
byte	2 ⁷	2 ⁶	2 ⁵	2 ⁴	2 ³	2 ²	2 ¹	2 ⁰
1	29 ₁₆							
2	T	0	circuit					
3	00 ₁₆							

Issue date: 20.4.2007

Request (if O ≡ 0)								
byte	2 ⁷	2 ⁶	2 ⁵	2 ⁴	2 ³	2 ²	2 ¹	2 ⁰
4	7A	6A	5A	4A	3A	2A	1A	–
...	...							
11	31B	30B	29B	28B	27B	26B	25B	24B

Request (if O ≡ 1)								
byte	2 ⁷	2 ⁶	2 ⁵	2 ⁴	2 ³	2 ²	2 ¹	2 ⁰
1	29 ₁₆							
2	T	1	circuit					
3	00 ₁₆							
4	–	1A	2A	3A	4A	5A	6A	7A
...	...							
11	24B	25B	26B	27B	28B	29B	30B	31B

Response								
byte	2 ⁷	2 ⁶	2 ⁵	2 ⁴	2 ³	2 ²	2 ¹	2 ⁰
1	29 ₁₆							
2	T	result						

11.3.5.8 Get list of projected slaves (GET_LPS)

With this call, the following entry is read out of the AS-i/DeviceNet Gateway: The list of projected AS-i slaves (*LPS*).

Request								
byte	2 ⁷	2 ⁶	2 ⁵	2 ⁴	2 ³	2 ²	2 ¹	2 ⁰
1	44 ₁₆							
2	T	O	circuit					

Response (if O ≡ 0)								
byte	2 ⁷	2 ⁶	2 ⁵	2 ⁴	2 ³	2 ²	2 ¹	2 ⁰
1	44 ₁₆							
2	T	result						
3	7A	6A	5A	4A	3A	2A	1A	0A
...	...							
10	31B	30B	29B	28B	27B	26B	25B	24B

Response (if O ≡ 1)								
byte	2 ⁷	2 ⁶	2 ⁵	2 ⁴	2 ³	2 ²	2 ¹	2 ⁰
1	44 ₁₆							
2	T	result						
3	0A	1A	2A	3A	4A	5A	6A	7A

Response (if O = 1)								
byte	2 ⁷	2 ⁶	2 ⁵	2 ⁴	2 ³	2 ²	2 ¹	2 ⁰
...	...							
10	24B	25B	26B	27B	28B	29B	30B	31B

11.3.5.9 Store actual parameters (STORE_PI)

With this call, the configured parameters stored on the EEPROM are overwritten with the current, permanently stored (actual) parameters; in other words, the current parameters of all AS-i slaves are stored.

Request								
byte	2 ⁷	2 ⁶	2 ⁵	2 ⁴	2 ³	2 ²	2 ¹	2 ⁰
1	04 ₁₆							
2	T	-	circuit					

Response								
byte	2 ⁷	2 ⁶	2 ⁵	2 ⁴	2 ³	2 ²	2 ¹	2 ⁰
1	04 ₁₆							
2	T	result						

11.3.5.10 Write parameter (WRITE_P)

The AS-i slave parameter value transferred with the command is passed on to the addressed AS-i slave.

The parameter is stored in the AS-i/DeviceNet Gateway only temporarily and is not stored as a configured parameter in the EEPROM!

The AS-i slave transfers its current parameter value in the response (parameter echo). This can deviate from the value that has just been written according to the AS-i master specification.

Request								
byte	2 ⁷	2 ⁶	2 ⁵	2 ⁴	2 ³	2 ²	2 ¹	2 ⁰
1	02 ₁₆							
2	T	-	circuit					
3	-		B	slave address				
4	-				parameter			

Response								
byte	2 ⁷	2 ⁶	2 ⁵	2 ⁴	2 ³	2 ²	2 ¹	2 ⁰
1	02 ₁₆							
2	T	result						
3	-				slave response			

Issue date - 20.4.2007

Meaning of bit B:

B = 0 Single AS-i slave or A-slave

B = 1 B-slave

11.3.5.11 Read parameter (READ_PI: Read_Parameter)

This call returns the current parameter value (actual parameter) of an AS-i slave sent by the AS-i/DeviceNet Gateway. This value must not be confused with the parameter echo that is supplied by the AS-i slave as a response to the write_p job.

This command can not be used for a directly reading of an AS-i parameter out of an AS-i slave.

Request								
byte	2 ⁷	2 ⁶	2 ⁵	2 ⁴	2 ³	2 ²	2 ¹	2 ⁰
1	03 ₁₆							
2	T	–	circuit					
3	–		B	slave address				

Response								
byte	2 ⁷	2 ⁶	2 ⁵	2 ⁴	2 ³	2 ²	2 ¹	2 ⁰
1	03 ₁₆							
2	T	result						
3	–			PI				

Meaning of bit B:

B = 0 Single AS-i slave or A-slave

B = 1 B-slave

11.3.5.12 Set permanent parameter (SET_PP)

With this call, a parameter value for the specified AS-i slave is configured. The value is stored permanently in the EEPROM of the gateway.

The configured parameter value is transferred only when the AS-i slave is activated after turning on the power supply on the AS-i/DeviceNet Gateway.

Request								
byte	2 ⁷	2 ⁶	2 ⁵	2 ⁴	2 ³	2 ²	2 ¹	2 ⁰
1	43 ₁₆							
2	T	–	circuit					
3	–		B	slave address				
4	–			PP				

Response								
byte	2 ⁷	2 ⁶	2 ⁵	2 ⁴	2 ³	2 ²	2 ¹	2 ⁰
1	43 ₁₆							
2	T	result						

11.3.5.13 Get permanent parameter (GET_PP)

With this call, a slave-specific parameter value stored on the EEPROM of the AS-i/ DeviceNet Gateway is read.

Request								
byte	2 ⁷	2 ⁶	2 ⁵	2 ⁴	2 ³	2 ²	2 ¹	2 ⁰
1	01 ₁₆							
2	T	–	circuit					
3	–		B	slave address				

Response								
byte	2 ⁷	2 ⁶	2 ⁵	2 ⁴	2 ³	2 ²	2 ¹	2 ⁰
1	01 ₁₆							
2	T	result						
3	–			PP				

Meaning of bit B:

B = 0 Single AS-i slave or A-slave

B = 1 B-slave

11.3.5.14 Set auto address enable (SET_AAE)

This call can enable or disable the "automatic address programming" function.

The AUTO_ADDR_ENABLE bit is stored permanently; in other words, it is retained after a warm/hot restart on the AS-i master.

Request								
byte	2 ⁷	2 ⁶	2 ⁵	2 ⁴	2 ³	2 ²	2 ¹	2 ⁰
1	0B ₁₆							
2	T	–	circuit					
3	Auto_Address_Enable							

Response								
byte	2 ⁷	2 ⁶	2 ⁵	2 ⁴	2 ³	2 ²	2 ¹	2 ⁰
1	0B ₁₆							
2	T	result						

11.3.5.15 Change slave address (SLAVE_ADDR)

With this call, the AS-i address of an AS-i slave can be modified.

This call is mainly used to add a new AS-i slave with the default address "0" to the AS-Interface. In this case, the address is changed from "AS-i slave address old" = 0 to "AS-i slave address new".

This change can only be made when the following conditions are fulfilled:

1. An AS-i slave with "AS-i slave address old" exists.
2. If the old AS-i slave address is not equal to 0, an AS-i slave with address "0" cannot be connected at the same time.
3. The "AS-i slave address new" must have a valid value.
4. An AS-i slave with "AS-i slave address new" must not exist.

 Note	When the AS-i slave address is changed, the AS-i slave is not reset, in other words, the output data of the AS-i slave are retained until new data are received at the new address.
--	---

Request								
byte	2 ⁷	2 ⁶	2 ⁵	2 ⁴	2 ³	2 ²	2 ¹	2 ⁰
1	0D ₁₆							
2	T	–	circuit					
3	–		B	source address				
4	–		B	target address				

Response								
byte	2 ⁷	2 ⁶	2 ⁵	2 ⁴	2 ³	2 ²	2 ¹	2 ⁰
1	0D ₁₆							
2	T	result						

Meaning of bit B:
 B = 0 Single AS-i slave or A-slave
 B = 1 B-slave

11.3.5.16 Write AS-i slave extended ID1 (WRITE_XID1)

With this call, the extended ID1 code of an AS-i slave with address "0" can be written directly via the AS-i cable. The call is intended for diagnostic purposes and is not required in the normal master mode.

The AS-i master passes the extended ID1 code on to the AS-i slave without any plausibility check.

Request								
byte	2 ⁷	2 ⁶	2 ⁵	2 ⁴	2 ³	2 ²	2 ¹	2 ⁰
1	3F ₁₆							
2	T	–	circuit					
3	–				xID1			
Response								
Byte	2 ⁷	2 ⁶	2 ⁵	2 ⁴	2 ³	2 ²	2 ¹	2 ⁰
1	3F ₁₆							
2	T	result						

11.3.6 Other commands

11.3.6.1 Overview of the commands

Values for command

see page	Command	Value	Meaning	Req Len	Res Len
page 116	Other commands				
page 117	IDLE	00 ₁₆	No request	2	2
page 117	READ_IDI	41 ₁₆	Read IDI	2	36
page 118	WRITE_ODI	42 ₁₆	Write ODI	34	2
page 118	READ_ODI	56 ₁₆	Read ODI	2	34
page 119	SET_OFFLINE	0A ₁₆	Set_Off-Line_Mode	3	2
page 120	SET_DATA_EX	48 ₁₆	Set_Data_Exchange_Active	3	2
page 120	BUTTONS	75 ₁₆	Disable Pushbuttons	3	2
page 120	FP_PARAM	7D ₁₆	„Functional Profile“ Param.	≥3	≥2
page 121	FP_DATA	7E ₁₆	„Functional Profile“ Data	≥3	≥2
page 122	INVERTER	7C ₁₆	Configure Inverter Slaves	12	4
page 122	MB_OP_CTRL_WR_FLAGS	0x85	Write Flags	≥5	2
page 123	MB_OP_CTRL_RD_FLAGS	0x86	Read Flags	4	≥3
page 123	RD_MFK_PARAM	0x59	Read SEW MFK21 Parameter	6	≥3

11.3.6.2 IDLE

When the value of "command" is zero, no request will be fulfilled.

Request								
byte	2 ⁷	2 ⁶	2 ⁵	2 ⁴	2 ³	2 ²	2 ¹	2 ⁰
1	00 ₁₆							
2	T	–	circuit					

Response								
byte	2 ⁷	2 ⁶	2 ⁵	2 ⁴	2 ³	2 ²	2 ¹	2 ⁰
1	00 ₁₆							
2	T	result						

11.3.6.3 Read input data image (READ_IDI)

With this call, the input data values of all AS-i slaves are read out of the AS-i/DeviceNet Gateway in addition to the cyclic data exchange. Though the command READ_IDI transmits all execution control flags (byte 3 and byte 4).

Request								
byte	2 ⁷	2 ⁶	2 ⁵	2 ⁴	2 ³	2 ²	2 ¹	2 ⁰
1	41 ₁₆							
2	T	–	circuit					

Response								
byte	2 ⁷	2 ⁶	2 ⁵	2 ⁴	2 ³	2 ²	2 ¹	2 ⁰
1	41 ₁₆							
2	T	result						
3	–							Pok
4	OR	APF	NA	CA	AAv	AAAs	s0	Cok
5	–				slave 1A			
6	slave 2A				slave 3A			
...			
36	slave 30B				slave 31B			

Pok Periphery_Ok
 S0 LDS.0
 AAAs Auto_Address_Assign
 AAv Auto_Address_Available
 CA Configuration_Active
 NA Normal_Operation_Active
 APF APF
 OR Offline_Ready
 Cok Config_Ok

11.3.6.4 Write output data image (WRITE_ODI)

With this call the output data values of all AS-i slaves are written in addition to the cyclic data exchange.

Request								
byte	2^7	2^6	2^5	2^4	2^3	2^2	2^1	2^0
1	42_{16}							
2	T	–	circuit					
3	–				slave 1A			
4	slave 2A				slave 3A			
...			
34	slave 30B				slave 31B			

Response								
byte	2^7	2^6	2^5	2^4	2^3	2^2	2^1	2^0
1	42_{16}							
2	T	result						

11.3.6.5 Read output data image (READ_ODI)

With this call, the output data values of all AS-i slaves is being read out of the AS-i/ DeviceNet Gateway.

Request								
byte	2^7	2^6	2^5	2^4	2^3	2^2	2^1	2^0
1	56_{16}							
2	T	–	circuit					

Response								
byte	2^7	2^6	2^5	2^4	2^3	2^2	2^1	2^0
1	56_{16}							
2	T	result						
3	–				slave 1A			
	slave 2A				slave 3A			
...			
34	slave 30B				slave 31B			

11.3.6.6 Set offline mode (SET_OFFLINE)

This call switches between online and offline mode.

The online mode is the normal operating state for the AS-i master. The following jobs are processed cyclically:

- During the data exchange phase, the fields of the output data are transferred to the slave outputs for all AS-i slaves in the LAS. The addressed AS-i slaves submit the values of the slave inputs to the master when the transfer was free of errors.
- This is followed by the inclusion phase in which existing AS-i slaves are searched and newly added AS-i slaves are entered in the LDS or LAS.
- In the management phase, jobs by the user such as writing parameters are executed.

In the offline mode, the AS-i/DeviceNet Gateway processes jobs by the user only. (Jobs that involve the immediate addressing of an AS-i slave are rejected with an error). There is no cyclic data exchange with the AS-i slaves.

When offline, the AS-i circuit is in a safe state.

The OFFLINE = TRUE bit is not permanently stored; in other words, following a cold/warm restart, the AS-i/DeviceNet Gateway is once again in the online mode.

Request								
byte	2 ⁷	2 ⁶	2 ⁵	2 ⁴	2 ³	2 ²	2 ¹	2 ⁰
1	0A ₁₆							
2	T	–	circuit					
3	Off-Line							

Response								
byte	2 ⁷	2 ⁶	2 ⁵	2 ⁴	2 ³	2 ²	2 ¹	2 ⁰
1	0A ₁₆							
2	T	result						

The master changes to the offline phase, if there is a 1 written in byte 3.

The master will change to online mode if there is a 0 written in byte 3.

11.3.6.7 Release data exchange (SET_DATA_EX)

Request								
byte	2^7	2^6	2^5	2^4	2^3	2^2	2^1	2^0
1	48_{16}							
2	T	-	circuit					
3	Data_Exchange_Active							

Response								
byte	2^7	2^6	2^5	2^4	2^3	2^2	2^1	2^0
1	48_{16}							
2	T	result						

11.3.6.8 BUTTONS

With this call, the use of the buttons can be enabled/disabled.

Request								
byte	2^7	2^6	2^5	2^4	2^3	2^2	2^1	2^0
1	75_{16}							
2	T	-	circuit					
3	Buttons disabled							

Response								
byte	2^7	2^6	2^5	2^4	2^3	2^2	2^1	2^0
1	75_{16}							
2	T	result						

11.3.6.9 FP_PARAM

This command is used for parametrization of "functional profiles".

The content of the request and response bytes depends on the called function (see chapter 11.4).

Request								
byte	2^7	2^6	2^5	2^4	2^3	2^2	2^1	2^0
1	$7D_{16}$							
2	T	-	circuit					
3	function							
4	request byte 1							
...	...							
n	request byte n-3							

Response								
byte	2 ⁷	2 ⁶	2 ⁵	2 ⁴	2 ³	2 ²	2 ¹	2 ⁰
1	7D ₁₆							
2	T	result						
3	response byte 1							
...	...							
n	response byte n-2							

11.3.6.10 FP_DATA

This command is used for the data exchange with "functional profiles".

The content of the request and response bytes depends on the called function (see chapter 11.4).

Request								
byte	2 ⁷	2 ⁶	2 ⁵	2 ⁴	2 ³	2 ²	2 ¹	2 ⁰
1	7E ₁₆							
2	T	-	circuit					
3	function							
4	request byte 1							
...	...							
n	request byte n-3							

Response								
byte	2 ⁷	2 ⁶	2 ⁵	2 ⁴	2 ³	2 ²	2 ¹	2 ⁰
1	7E ₁₆							
2	T	result						
3	response byte 1							
...	...							
n	response byte n-2							

11.3.6.11 Inverter

With this call, an AS-i slave for frequency inverters is switched from cyclical mode to the transmission mode of four 16-bit values, in order to operate again with the selected AS-i destination parameter.

Request								
byte	2^7	2^6	2^5	2^4	2^3	2^2	2^1	2^0
1	$7C_{16}$							
2	T	-	circuit					
3	slave address							
4	destination parameter							
5	value 1, high byte							
6	value 1, low byte							
7	value 2, high byte							
8	value 2, low byte							
9	value 3, high byte							
10	value 3, low byte							
11	value 4, high byte							
12	value 4, low byte							

Response								
byte	2^7	2^6	2^5	2^4	2^3	2^2	2^1	2^0
1	$7C_{16}$							
2	T	result						

11.3.6.12 Write Flag

Use this command to write the flag of a control program.

The control program of devices with control functions takes on data from the interface.

Request								
Byte	2^7	2^6	2^5	2^4	2^3	2^2	2^1	2^0
1	0x85							
2	T	-	circuit					
3	introductory address							
4	number n							
5	number 1							
...	...							
n	number n							

Response								
Byte	2^7	2^6	2^5	2^4	2^3	2^2	2^1	2^0
1	0x85							

Issue date: 20.4.2007

Response								
Byte	2 ⁷	2 ⁶	2 ⁵	2 ⁴	2 ³	2 ²	2 ¹	2 ⁰
2	T	result						

11.3.6.13 Read Flag

Use this command to read out the flags of a control program.

The control program of devices with control functions takes on data from the interface.

Request								
Byte	2 ⁷	2 ⁶	2 ⁵	2 ⁴	2 ³	2 ²	2 ¹	2 ⁰
1	0x86							
2	T	–	circuit					
3	introductory address							
4	number n							

Response								
Byte	2 ⁷	2 ⁶	2 ⁵	2 ⁴	2 ³	2 ²	2 ¹	2 ⁰
1	0x86							
2	T	result						
3	data 1							
...								
n	data n							

11.3.6.14 READ_MFK_PARAM

Use this command to read multiple commands of a SEW MFK21 slave.

Request								
Byte	2 ⁷	2 ⁶	2 ⁵	2 ⁴	2 ³	2 ²	2 ¹	2 ⁰
1	0x59							
2	T	–	circuit					
3	slave							
4	index high							
5	index low							
6	number (n)							

Response								
Byte	2 ⁷	2 ⁶	2 ⁵	2 ⁴	2 ³	2 ²	2 ¹	2 ⁰
1	0x59							
2	T	result						
3	prm byte (index)							
4	prm byte (index+1)							
n+2	prm byte (index+n-1)							

Issue date - 20.4.2007

11.4 Functional profiles

11.4.1 "Safety at Work" List 1

 Note	<p>This function has been implemented only for reasons of the downwards compatibility.</p> <p>By AS-i 3.0 Masters, the state of the "safety input slaves" is specified on the image of the input data (0000 released).</p>
--	--

Function: 00₁₆

List of "safety-directed input slaves" ("AS-i Safety at Work"), whose safety function is released.

Safety-directed input slaves have the profile S-7.B or S-0.B (IO = 0 or 7, ID = B, see chapter 11.3.5.4: Read Actual Configuration).

The "Safety at Work" list 1 is a bit list which contains a bit for each possible slave address (1 - 31). This list is written in the bytes 5 until 8 in the response of the command of the command interface. Additionally, the response contains the ec-flags of the AS-i master in the bytes 3 and 4 (see chapter 11.3.4.3: "Get Flags").

The bits of the "Safety at Work" list 1 are set if the safety function of the slave is activated (e.g. emergency button pressed). The bit is only set at security slaves when both contacts are released, otherwise the bits have the value 0. "Normal" (non-security) slaves also have the value 0.

Since the safety monitor is also being activated when a safety slave is missing or if the AS-i circuit is shut off (offline active), the ec-flags will also be transmitted. It is sufficient however to monitor the group error message Cok (configuration error). As long as no configuration error, the list of the "safety-directed input slaves" can be used.

Configured safety slaves which are not available, and available slaves sending a wrong coder order, will not be entered in this list.

With the bit "O", the sequence of the bits within the "Safety at Work" list 1 can be chosen.

```

Cok  Config_Ok
S0   LDS.0
AAs  Auto_Address_Assign
AAv  Auto_Address_Available
CA   Configuration_Active
NA   Normal_Operation_Active
APF  APF
OR   Offline_Ready
Pok  Periphery_Ok
    
```

Example for O ≡ 0:

```

Configuration OK,
periphery OK (no peripheral fault),
2 safety slaves with released safety function,
AS-Interface addresses 4 and 10
    
```

1 safety slave with unreleased safety function,
AS-Interface address 5.

Reponse: 7E 00 01 25 10 04 00 00

Function: 0D₁₆

There is a funktion **0D₁₆** in addition to the funktion **00₁₆** . The funktion **0D₁₆** has no EcFlags in the response. The response falls short for 2 bytes.

Request								
Byte	2 ⁷	2 ⁶	2 ⁵	2 ⁴	2 ³	2 ²	2 ¹	2 ⁰
1	7E ₁₆							
2	T	O	circuit					
3	0Dh							

Response (by O ≡ 0)								
Byte	2 ⁷	2 ⁶	2 ⁵	2 ⁴	2 ³	2 ²	2 ¹	2 ⁰
1	7E ₁₆							
2	T	response						
3	7	6	5	4	3	2	1	–
4	15	14	13	12	11	10	9	8
5	23	22	21	20	19	18	17	16
6	31	30	29	28	27	26	25	24

Response (by O ≡ 1)								
Byte	2 ⁷	2 ⁶	2 ⁵	2 ⁴	2 ³	2 ²	2 ¹	2 ⁰
1	7E ₁₆							
2	T	response						
3	–	1	2	3	4	5	6	7
4	8	9	10	11	12	13	14	15
5	16	17	18	19	20	21	22	23
6	24	25	26	27	28	29	30	31

11.4.2 "Safety at Work" Monitor diagnosis

Function: 02₁₆

Since the "Safety at Work" monitor can generate more than 32 Byte diagnosis data, these must be read with several command interface calls. The byte 5 declares the start index in the field of the diagnosis data.

If the start index is 0, new data is fetched from the monitor. Otherwise, the function will respond out of the memory; the data can be read consistently.

11.4.2.1 Setting of the AS-i diagnosis



Note

The function **unsorted diagnosis** is available only with monitors in the version 2.0 and higher.

The function **sorted diagnosis** is available with all monitors.

The setting of the AS-i diagnosis takes place in the window "Information about monitor and bus" of the configuration software **asimon** for the AS-i safety monitor.

- Call up the menu *Edit/Information about monitor and bus*

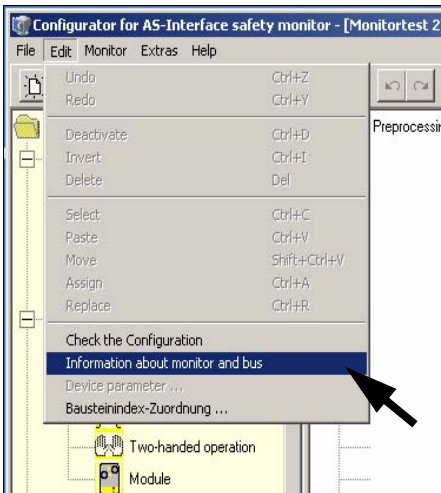

Fig. 1. Calling of Information about monitor and bus

- Set the function range in the window *Information about monitor and bus*

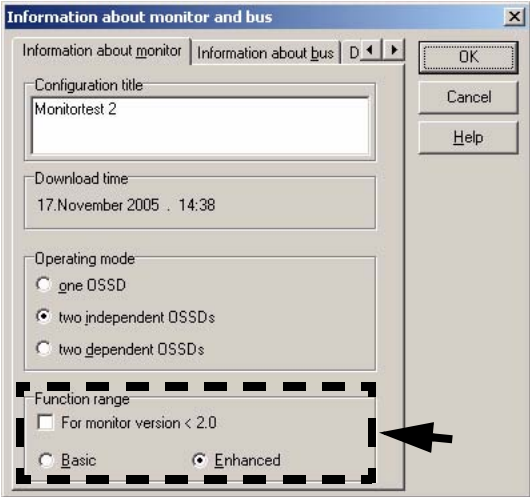

Fig. 2. Setting of function range

- Select in the window *Information about monitor and bus* the tab *Diagnosis/Service*
- Select within the range *Data selection sorted* (sorted by OSSD) or *unsorted* (all devices)

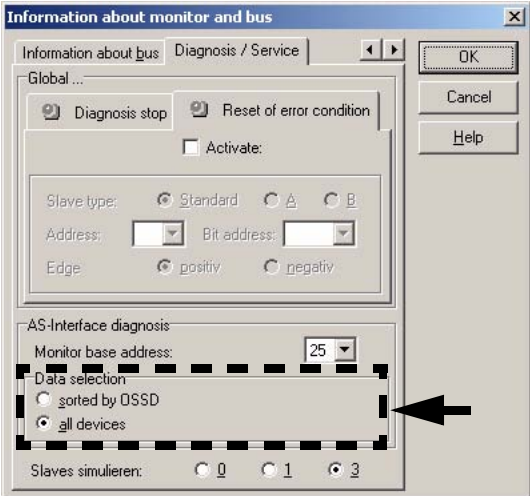

Fig. 3. Data selection (sorted/unsorted)

Issue date - 20.4.2007

11.4.2.2 Enhanced diagnosis

Since the "Safety at Work" monitor diagnosis is longer than the maximum size of the command interface, it must be read with several adjacent requests.

The byte 5 ('index') declares the start index in the array of diagnostic data. If this start index is 0, the whole diagnosis is fetched from the monitor and stored to an internal buffer. Otherwise, the AS-i Master will respond out of the internal buffer. Thus, even though several requests are necessary to read the whole buffer, data integrity is maintained.

Request								
byte	2^7	2^6	2^5	2^4	2^3	2^2	2^1	2^0
1	$7E_{16}$							
2	T	L^1	U^2	circuit				
3	02_{16}							
4	slave address							
5	index							

1. $L=1$ long diagnosis for advanced monitor
2. $U=1$ unsorted diagnosis (all devices)

Response								
byte	2^7	2^6	2^5	2^4	2^3	2^2	2^1	2^0
1	$7E_{16}$							
2	T	result						
3	diagnosis byte #index+0							
4	diagnosis byte #index+1							
...	...							
n	diagnosis byte #index+n-3							

The diagnosis array is set up as follows:

Safety Monitor Diagnosis Array "basic function range" and "sorted by OSSD"								
byte	2^7	2^6	2^5	2^4	2^3	2^2	2^1	2^0
0	00 ₁₆							
1	state of monitor							
2	state of OSSD1							
3	state of OSSD2							
4	number of devices not green, OSSD1							
5	number of devices not green, OSSD2							
6	device index 32, OSSD1							
7	color of device 32, OSSD1							
8	device index 33, OSSD1							
9	color of device 33, OSSD1							
...	...							
68	device index 63, OSSD1							
69	color of device 63, OSSD1							
70	device index 32, OSSD2							
71	color of device 32, OSSD2							
...	...							
132	device index 63, OSSD2							
133	color of device 63, OSSD2							

Safety Monitor Diagnosis Array "enhanced function range" and "sorted by OSSD"								
byte	2^7	2^6	2^5	2^4	2^3	2^2	2^1	2^0
0	00 ₁₆							
1	state of monitor							
2	state of OSSD1							
3	state of OSSD2							
4	number of devices not green, OSSD1							
5	number of devices not green, OSSD2							
6	device index 32, OSSD1							
7	color of device 32, OSSD1							
8	device index 33, OSSD1							
...	...							
133	color of device 95, OSSD1							
134	device index 32, OSSD2							
...	...							
261	color of device 95, OSSD2							

Issue date - 20.4.2007

Safety Monitor Diagnosis Array "basic function range" and "all devices"								
byte	2 ⁷	2 ⁶	2 ⁵	2 ⁴	2 ³	2 ²	2 ¹	2 ⁰
0	00 ₁₆							
1	state of monitor							
2	state of OSSD1							
3	state of OSSD2							
4	number of devices not green							
5	—							
6	device index 32							
7	color of device 32							
8	device index 33							
9	color of device 33							
...	...							
68	device index 63							
69	color of device 63							
70	device index 32							
71	assignment of device 32 to OSSD							
...	...							
132	device index 63							
133	assignment of device 63 to OSSD							

Safety Monitor Diagnosis Array "enhanced function range" and "all devices"								
byte	2 ⁷	2 ⁶	2 ⁵	2 ⁴	2 ³	2 ²	2 ¹	2 ⁰
0	00 ₁₆							
1	state of monitor							
2	state of OSSD1							
3	state of OSSD2							
4	number of devices not green							
5	—							
6	device index 32							
7	color of device 32							
8	device index 33							
...	...							
133	color of device 95							
134	device index 32							
135	assignment of device 32 to OSSD2							
...	...							
261	assignment of device 95 to OSSD							

Issue date: 20.4.2007

Possible assignment:

00₁₆: preprocessing

01₁₆: OSSD 1

02₁₆: OSSD 2

03₁₆: OSSD 1+2

80₁₆: device does not exist

See the "Safety at Work" monitor documentation for a description of the codes used for monitor state, OSSD state, device colors and assignments to OSSDs.

11.4.3 Integrated AS-i Sensors: Warnings

Function: 03₁₆

List of integrated AS-i sensors according to profile S-1.1 (without extended addressing) or profile S-3.A.1 (with extended addressing), by which the input data bit D1 ("Warning") being deleted.

For creating of this list CDI and IDI are used only. Integrated AS-i slaves which are projected but not existing therefore are not entered here.

Request								
byte	2 ⁷	2 ⁶	2 ⁵	2 ⁴	2 ³	2 ²	2 ¹	2 ⁰
1	7E ₁₆							
2	T	O	circuit					
3	03 ₁₆							

Response (if O ≡ 0)								
byte	2 ⁷	2 ⁶	2 ⁵	2 ⁴	2 ³	2 ²	2 ¹	2 ⁰
1	7E ₁₆							
2	T	result						
3	7A	6A	5A	4A	3A	2A	1A	0
...	...							
10	31B	30B	29B	28B	27B	26B	25B	24B

Response if O ≡ 1)								
byte	2 ⁷	2 ⁶	2 ⁵	2 ⁴	2 ³	2 ²	2 ¹	2 ⁰
1	7E ₁₆							
2	T	result						
3	0	1A	2A	3A	4A	5A	6A	7A
...	...							
10	24A	25A	26A	27A	28A	29A	30A	31A

11.4.4 Integrated AS-i sensors: Availability

Function: 04₁₆

List of the integrated slaves according to profile S-1.1 whose input data bits D2 ("Availability") are deleted.

For creating this list, CDI and IDI are used only. Integrated AS-i slaves which are projected but not existing therefore are not entered here.

Request								
byte	2 ⁷	2 ⁶	2 ⁵	2 ⁴	2 ³	2 ²	2 ¹	2 ⁰
1	7E ₁₆							
2	T	O	circuit					
3	04 ₁₆							

Response (if O ≡ 0)								
byte	2 ⁷	2 ⁶	2 ⁵	2 ⁴	2 ³	2 ²	2 ¹	2 ⁰
1	7E ₁₆							
2	T	result						
3	7	6	5	4	3	2	1	0
...	...							
6	31	30	29	28	27	26	25	24

Response (if O ≡ 1)								
byte	2 ⁷	2 ⁶	2 ⁵	2 ⁴	2 ³	2 ²	2 ¹	2 ⁰
1	7E ₁₆							
2	T	result						
3	0	1	2	3	4	5	6	7
...	...							
6	24	25	26	27	28	29	30	31

11.4.5 Language-select

Function 0E₁₆

Use this function to set the display language.

Set:

Request								
Byte	2 ⁷	2 ⁶	2 ⁵	2 ⁴	2 ³	2 ²	2 ¹	2 ⁰
1	7D ₁₆							
2	T	-	circuit					
3	0E ₁₆							
4	language ¹							

1. Value: 0= default (no changes), 1= english, 2= german, 3= french, 4= italian, 5= spain.

Issue date - 20.4.2007

Response								
Byte	2 ⁷	2 ⁶	2 ⁵	2 ⁴	2 ³	2 ²	2 ¹	2 ⁰
1	7D ₁₆							
2	T	result						

Read:

Request								
Byte	2 ⁷	2 ⁶	2 ⁵	2 ⁴	2 ³	2 ²	2 ¹	2 ⁰
1	7E ₁₆							
2	T	-	circuit					
3	0E ₁₆							

Response								
Byte	2 ⁷	2 ⁶	2 ⁵	2 ⁴	2 ³	2 ²	2 ¹	2 ⁰
1	7E ₁₆							
2	T	result						
3	language ¹							

1. Value: 0= default (no changes), 1= english, 2= german, 3= french, 4= italian, 5= spanish.

11.4.6 Replacement of Safety Slaves input data

Function 0F₁₆

Use this function to replace safety slaves input data with "interpretation data". If the function is active, so have safety slaves input data the following meaning:

Bit 0,1: 00=channel 1 has released 11=channel 1 has not released.

Bit 2,3: 00=channel 2 has released, 11=channel 2 has not released.

 Note	This command replaces the old command MB_FP_LSS_ENABLE
--	--

Set:

Request								
Byte	2 ⁷	2 ⁶	2 ⁵	2 ⁴	2 ³	2 ²	2 ¹	2 ⁰
1	7D ₁₆							
2	T	-	circuit					
3	0F ₁₆							
4	safety slaves ¹							

1. Value: 0= no substitute value, 1=substitute value for safety slaves

Response								
Byte	2^7	2^6	2^5	2^4	2^3	2^2	2^1	2^0
1	$7D_{16}$							
2	T	result						

Read:

Request								
Byte	2^7	2^6	2^5	2^4	2^3	2^2	2^1	2^0
1	$7E_{16}$							
2	T	-	circuit					
3	$0F_{16}$							

Response								
Byte	2^7	2^6	2^5	2^4	2^3	2^2	2^1	2^0
1	$7E_{16}$							
2	T	result						
4	safety slaves ¹							

1. Value: 0= no substitute value, 1=substitute value for safety slaves

11.4.7 List of Safety Slaves

Function 10_{16}

Use this function to find out the addresses of safety slaves.

Read:

Request								
Byte	2^7	2^6	2^5	2^4	2^3	2^2	2^1	2^0
1	$7D_{16}$							
2	T	O^1	circuit					
3	10_{16}							

1. O = orientation

Response (by $O \equiv 0$)								
Byte	2^7	2^6	2^5	2^4	2^3	2^2	2^1	2^0
1	$7D_{16}$							
2	T	result						
3	7	6	5	4	3	2	1	0
...	...							
6	31	30	29	28	27	26	25	24

Issue date - 20.4.2007

Response (bei O ≡ 1)								
Byte	2 ⁷	2 ⁶	2 ⁵	2 ⁴	2 ³	2 ²	2 ¹	2 ⁰
1	7D ₁₆							
2	T	result						
3	0	1	2	3	4	5	6	7
...	...							
6	24	25	26	27	28	29	30	31

11.5 Command Interface examples

You can find actual command interface examples in the download area of the homepage.

11.5.1 Reading 16-bit input values

Command RD_7X_IN: Reading of 16-bit input values.

Meaning of the bytes:

Request: RD_7X_IN	
Byte 1	50 _{hex} (RD_7X_IN)
Byte 2	00 _{hex} (master 1, single master)
Byte 3	1D _{hex} (slave address 29)
Byte 4	00 _{hex}
...	...
Byte 12	00 _{hex}

Response	
Byte 1	00 _{hex} (or old values)
Byte 2	00 _{hex} (or old values)
Byte 3	00 _{hex} (or old values)
Byte 4	00 _{hex} (or old values)
...	...
Byte 12	00 _{hex} (or old values)

The call of the command interface has not been answered with the valid values since the toggle bit has not been set.

Set of toggle bit:

Request	
Byte 1	50 _{hex}
Byte 2	80 _{hex} (toggle bit, result)
Byte 3	1D _{hex} (slave address 29)
Byte 4	00 _{hex}
...	...

Issue date - 20.4.2007

Request	
Byte 12	00 _{hex}

Result: See chapter 11.2.1 "Values for results"

Response	
Byte 1	50 _{hex}
Byte 2	80 _{hex} (toggle bit, master1)
Byte 3	16-bit channel 1 high byte _{hex}
Byte 4	16-bit channel 1 low byte _{hex}
Byte 5	16-bit channel 2 high byte _{hex}
Byte 6	16-bit channel 2 low byte _{hex}
Byte 7	16-bit channel 3 high byte _{hex}
Byte 8	16-bit channel 3 low byte _{hex}
Byte 9	16-bit channel 4 high byte _{hex}
Byte 10	16-bit channel 4 low byte _{hex}
Byte 11	00 _{hex} not used
Byte 12	00 _{hex} not used

To get the input data again, the T-bit has to be reset again.

11.5.2 Store current configuration to the AS-i master

1. Switch master to configuration mode
2. Write the current slave configuration to the master
3. Switch master to protected mode
4. Wait until master is in normal (protected) operation mode

12-byte management

1. Switch master to config mode

Request: SET_OP_MODE	
Byte 1	0C _{hex} (SET_OP_MODE)
Byte 2	00 _{hex} (T = 0, master 1, single master)
Byte 3	01 _{hex} (= config mode)
Byte 4	00 _{hex}
...	...
Byte 12	00 _{hex}

Response	
Byte 1	00 _{hex} (or old values)
Byte 2	00 _{hex} (or old values)
...	...
Byte 12	00 _{hex} (or old values)

Issue date - 20.4.2007

No result because toggle bit = 0.

Set the toggle bit:

Request: SET_OP_MODE	
Byte 1	0C _{hex} (SET_OP_MODE)
Byte 2	80 _{hex} (T = 1, master 1, single master)
Byte 3	01 _{hex} (= config mode)
Byte 4	00 _{hex}
...	...
Byte 12	00 _{hex}

Response	
Byte 1	0C _{hex}
Byte 2	80 _{hex} (T = 1, result = 0)
Byte 3	00 _{hex} (or old values)
...	...
Byte 12	00 _{hex} (or old values)

Master is now in configuration mode.

Result = 0 ⇒ No error, for other result codes see chapter 11.2.1 "Values for results".

2. Write the actual slave configuration to the master

Request: STORE_CDI	
Byte 1	07 _{hex} (STORE_CDI)
Byte 2	00 _{hex} (T = 0, master 1, single master)
Byte 3	00 _{hex}
...	...
Byte 12	00 _{hex}

Response	
Byte 1	00 _{hex} (or old values)
Byte 2	00 _{hex} (or old values)
...	...
Byte 12	00 _{hex} (or old values)

No result because toggle bit = 0.

Set the toggle bit:

Request: STORE_CDI	
Byte 1	07 _{hex} (STORE_CDI)
Byte 2	80 _{hex} (T = 0, master 1, single master)
Byte 3	00 _{hex}
...	...
Byte 12	00 _{hex}

Response	
Byte 1	00 _{hex}
Byte 2	80 _{hex} (T = 1, result = 0)
Byte 3	00 _{hex} (or old values)
...	...
Byte 12	00 _{hex} (or old values)

The current configuration data has been written.

3. Set master to protected mode

Request: SET_OP_MODE	
Byte 1	0C _{hex} (SET_OP_MODE)
Byte 2	00 _{hex} (T = 0, master 1, single master)
Byte 3	00 _{hex} (= protected mode)
Byte 4	00 _{hex}
...	...
Byte 12	00 _{hex}

Response	
Byte 1	00 _{hex} (or old values)
Byte 2	00 _{hex} (or old values)
...	...
Byte 12	00 _{hex} (or old values)

No result because toggle bit = 0.

Set the toggle bit:

Request: SET_OP_MODE	
Byte 1	0C _{hex} (SET_OP_MODE)
Byte 2	80 _{hex} (T = 1, master 1, single master)
Byte 3	00 _{hex} (= protected mode)
Byte 4	00 _{hex}
...	...
Byte 12	00 _{hex}

Response	
Byte 1	0C _{hex}
Byte 2	80 _{hex} (T = 1, result = 0)
Byte 3	00 _{hex} (or old values)
...	...
Byte 12	00 _{hex} (or old values)

The master has now been ordered to switch to the protected mode. It must be maintained now until the master changes into the operation mode.

4. Wait until master is in normal operation mode (and protected mode)

Reading out the flags until NA (Normal Operation Active) has been set.

Request: GET_FLAGS	
Byte 1	47 _{hex} (GET_FLAGS)
Byte 2	00 _{hex} (T = 0, master 1, single master)
Byte 3	00 _{hex}
...	...
Byte 12	00 _{hex}

Response	
Byte 1	00 _{hex} (or old values)
Byte 2	00 _{hex} (or old values)
...	...
Byte 12	00 _{hex} (or old values)

No result because toggle bit = 0.

Setting the toggle bit:

Request: GET_FLAGS	
Byte 1	47 _{hex} (GET_FLAGS)
Byte 2	00 _{hex} (T = 0, master 1, single master)
Byte 3	00 _{hex}
Byte 4	00 _{hex}
...	...
Byte 12	00 _{hex}

Response								
Byte 1	47 _{hex}							
Byte 2	80 _{hex} (T = 1, result = 0)							
Byte 3	-	-	-	-	-	-	-	POK
Byte 4	OR	APF	NA	CA	AAv	AAs	S0	COK
Byte 5						AAe	OL	DX
Byte 6	00 _{hex}							
...	...							
Byte 12	00 _{hex}							

The flag NA has to be set before the application is started. In case it is not set, the flags have to be read out until this flag has been set to 1.

The flag NA indicates that the master is in normal operation mode.

Normal operation mode is necessary to run the application safely.

11.5.3 Store new configuration for all slaves

1. Switch master in configuration mode
2. Write slave configuration to master
3. Write new list of projected slaves (*LPS*)
4. Write permanent parameter (*PP*) to master
5. Switch master to protected mode
6. Wait until master is in normal operation Mode (and protected mode)

12-byte management

1. Set master in config mode

Request: SET_OP_MODE	
Byte 1	0C _{hex} (SET_OP_MODE)
Byte 2	00 _{hex} (T = 0, master 1, single master)
Byte 3	01 _{hex} (= config mode)
Byte 4	00 _{hex}
...	...
Byte 12	00 _{hex}

Issue date - 20.4.2007

Response	
Byte 1	00 _{hex} (or old values)
Byte 2	00 _{hex} (or old values)
Byte 3	00 _{hex} (or old values)
Byte 4	00 _{hex} (or old values)
...	...
Byte 12	00 _{hex} (or old values)

No result because toggle bit = 0.

Set the toggle bit:

Request: SET_OP_MODE	
Byte 1	0C _{hex} (SET_OP_MODE)
Byte 2	80 _{hex} (T = 1, master 1, single master)
Byte 3	01 _{hex} (= config mode)
Byte 4	00 _{hex}
...	...
Byte 12	00 _{hex}

Response	
Byte 1	0C _{hex}
Byte 2	80 _{hex} (T = 1, result = 0)
Byte 3	00 _{hex} (or old values)
Byte 4	00 _{hex} (or old values)
...	...
Byte 12	00 _{hex} (or old values)

The master is now in configuration mode.

Result: See chapter 11.2.1 "Values for results".

2. Write single configuration to master

Writing a configuration of an AS-i slave to the master.

For example:

16-bit input 4 CH at address 4 (Slave datasheet)

ID: 3_{hex}

ID2: E_{hex}

IO: 7_{hex}

ID1: F_{hex}

Request: SET_PCD	
Byte 1	25 _{hex} (SET_PCD)
Byte 2	00 _{hex} (T = 0, master 1, single master)
Byte 3	04 _{hex} (slave address to write to master)
Byte 4	EF _{hex} (ID + IO to configurate)
Byte 5	37 _{hex} (xID2 + xID1 to configurate)
Byte 6	00 _{hex}
...	...
Byte 12	00 _{hex}

Response	
Byte 1	00 _{hex} (or old values)
Byte 2	00 _{hex} (or old values)
Byte 3	00 _{hex} (or old values)
Byte 4	00 _{hex} (or old values)
...	...
Byte 12	00 _{hex} (or old values)

No result because toggle bit = 0.

Set the toggle bit:

Request: SET_PCD	
Byte 1	0C _{hex} (SET_PCD)
Byte 2	80 _{hex} (T = 1, master 1, single master)
Byte 3	04 _{hex} (slave address to write to master)
Byte 4	EF _{hex} (ID + IO to configurate)
Byte 5	37 _{hex} (ID + IO to configurate)
Byte 6	00 _{hex}
...	...
Byte 12	00 _{hex}

Response	
Byte 1	25 _{hex}
Byte 2	80 _{hex} (T = 1, result = 0)
Byte 3	00 _{hex} (or old values)
Byte 4	00 _{hex} (or old values)
...	...
Byte 12	00 _{hex} (or old values)

The single slave configuration for the 16-bit module is written.

This command must be repeated for all 31 A-slaves and all 31 B-slaves. If you don't connect a slave to an address, write F_{hex} for ID, IO, ID1, ID2.

3. Write new list of projected slaves

Write the complete LPS of your AS-i circuit.

Every bit in the LPS corresponds to one slave after the following scheme:

- Byte0/Bit 0:slave 0/0A - can not be set!
 - Byte1/Bit 1:slave 1/1A
 - ...
 - Byte3/Bit 7:slave 31/31A
 - Byte4/Bit 0:slave 0B - can not be set!
 - Byte4/Bit 1:slave 1B
 - ...
 - Byte7/Bit 7:slave 31B
- The slave is projected if the bit is set.

Example above: 16-bit module at address 4 ⇒ Set bit 4/byte 0:

Request: SET_LPS	
Byte 1	29 _{hex} (SET_LPS)
Byte 2	00 _{hex} (T = 0, master 1, single master)
Byte 3	00 _{hex}
Byte 4	10 _{hex} (LDS byte 0)
Byte 5	00 _{hex} (LDS byte 1)
...	...
Byte 11	00 _{hex} (LDS byte 7)
Byte 12	00 _{hex}

Response	
Byte 1	00 _{hex} (or old values)
Byte 2	00 _{hex} (or old values)
...	...
Byte 12	00 _{hex} (or old values)

No result because toggle bit = 0.

Setting the toggle bit:

Request: SET_LPS	
Byte 1	29 _{hex}
Byte 2	80 _{hex} (T = 1, master 1, single master)
Byte 3	00 _{hex}
Byte 4	10 _{hex} (LDS byte 0)
Byte 5	00 _{hex} (LDS byte 1)
...	...
Byte 11	00 _{hex} (LDS byte 7)
Byte 12	00 _{hex}

Response	
Byte 1	29 _{hex}
Byte 2	80 _{hex} (T = 1, result = 0)
Byte 3	00 _{hex} (or old values)
...	...
Byte 12	00 _{hex} (or old values)

The new list of protected slaves (LPS) is written.

4. Write permanent parameter (power on parameter) to master

Example as above: 16-bit module at address 4 with PP = 07_{hex}

Request: SET_PP	
Byte 1	43 _{hex} (SET_PP)
Byte 2	00 _{hex} (T = 0, master 1, single master)
Byte 3	04 _{hex} (slave address to write to master)
Byte 4	07 _{hex} (PP to write (use low nibble))
Byte 5	00 _{hex} (LDS byte 1)
...	...
Byte 12	00 _{hex}

Response	
Byte 1	00 _{hex} (or old values)
Byte 2	00 _{hex} (or old values)
...	...
Byte 12	00 _{hex} (or old values)

No result because toggle bit = 0

Setting the toggle bit:

Request: SET_PP	
Byte 1	43 _{hex} (SET_PP)
Byte 2	80 _{hex} (T = 0, master 1, single master)
Byte 3	04 _{hex} (slave address to write to master)
Byte 4	07 _{hex} (PP to write (use low nibble))
Byte 5	00 _{hex}
...	...
Byte 12	00 _{hex}

Response	
Byte 1	43 _{hex}
Byte 2	80 _{hex} (T = 1, Result = 0)
Byte 3	00 _{hex}
...	...
Byte 12	00 _{hex}

The permanent parameter for the 16-bit module is written.

This command must be repeated for all 31 A-slaves and all 31 B-slaves. If you don't connect a slave to an address, write the default value to the master (F_{hex}) as a permanent parameter.

5. Switch Master to Protected Mode

Request: SET_OP_MODE	
Byte 1	0C _{hex} (SET_OP_MODE)
Byte 2	00 _{hex} (T = 0, master 1, single master)
Byte 3	00 _{hex} (= protected mode)
Byte 4	00 _{hex}
...	...
Byte 12	00 _{hex}

Response	
Byte 1	00 _{hex} (or old values)
Byte 2	00 _{hex} (or old values)
...	...
Byte 12	00 _{hex} (or old values)

No result because toggle bit = 0.

Setting the toggle bit:

Request: SET_OP_MODE	
Byte 1	0C _{hex} (SET_OP_MODE)
Byte 2	80 _{hex} (T = 1, master 1, single master)
Byte 3	00 _{hex} (= protected mode)
Byte 4	00 _{hex}
...	...
Byte 12	00 _{hex}

Response	
Byte 1	0C _{hex}
Byte 2	80 _{hex} (T = 1, result = 0)
Byte 3	00 _{hex} (or old values)
...	...
Byte 12	00 _{hex} (or old values)

The master has now been ordered to switch to protected mode.

6. Wait until master is in normal (protected) operation mode

Read out the flags, until the NA (Normal Operation Active) has been set.

Request: GET_FLAGS	
Byte 1	47 _{hex} (GET_FLAGS)
Byte 2	00 _{hex} (T = 0, master 1, single master)
Byte 3	00 _{hex}
...	...
Byte 12	00 _{hex}

Response	
Byte 1	00 _{hex} (or old values)
Byte 2	00 _{hex} (or old values)
...	...
Byte 12	00 _{hex} (or old values)

No result because toggle bit = 0.

Setting the toggle bit:

Request: GET_FLAGS	
Byte 1	47 _{hex} (GET_FLAGS)
Byte 2	00 _{hex} (T = 0, master 1, single master)
Byte 3	00 _{hex}
Byte 4	00 _{hex}
...	...
Byte 12	00 _{hex}

Response								
Byte 1	47 _{hex}							
Byte 2	80 _{hex} (T = 1, result = 0)							
Byte 3	-	-	-	-	-	-	-	POK
Byte 4	OR	APF	NA	CA	AAv	AAs	S0	COK
Byte 5						AAe	OL	DX
Byte 6	00 _{hex}							
...	...							
Byte 12	00 _{hex}							

The flag NA has to be set before the application is started. In case it is not set, the flags have to be read out until this flag has been set to 1.

The flag NA indicates that the master is in normal operation mode.

Normal operation mode is necessary to run the application safely.

The flag NA indicates that the master is in the normal operating mode which is necessary for the application to run safely.

12 Commissioning Tools and Accessories

The Windows based software "AS-i Control Tools" is designed to make the commissioning of the AS-i/DeviceNet Gateway so easy as possible.

The software communicates with the AS-i/DeviceNet Gateway using a DeviceNet Master Simulator with USB interface or the integrated RS 232 diagnostic interface.

12.1 Windows software AS-i Control Tools

The Windows software "AS-i Control Tools" enables you to configure the AS-i circuit in a very comfortable way.

1. For this purpose plug in the Master Simulator to the CAN-connector of the AS-i/DeviceNet Gateway and connect the device over the RS 232 interface with a fully covered cable to a USB interface of your PC.
2. Start the AS-i-Control-Tools.
3. Call the command Master | New.

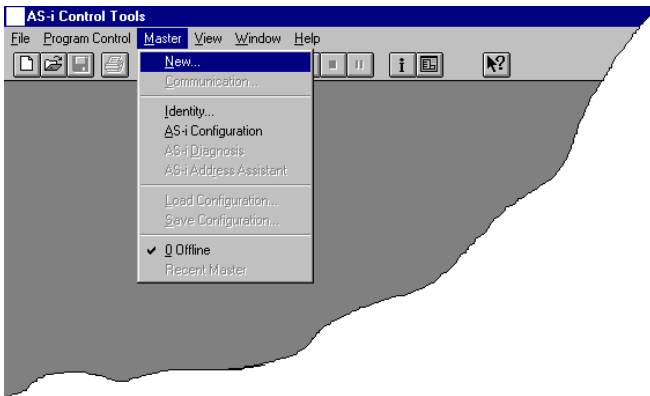

4. Choose DeviceNet as protocol.

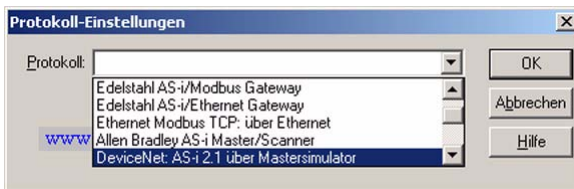

AS-i DeviceNet Gateway Commissioning Tools and Accessories

5. Do the appropriate settings. (e.g. USB interface, bus-address, baud rate, AS-i circuit <1>)



6. Call the command Master | AS-i configuration.
The AS-i configuration editor will be started. All detected and projected AS-i slaves are displayed in this window.
7. Click on a slave entry to open the dialog box slave configuration.



Changing a slave address, setting AS-i parameters or AS-i configuration data is possible here. Additionally, inputs and outputs can be tested.

AS-Interface Commissioning Tools and Accessories

- Click in the main menu on the second button from the right side to acquire a graphic presentation of the "AS-i Control Tools".

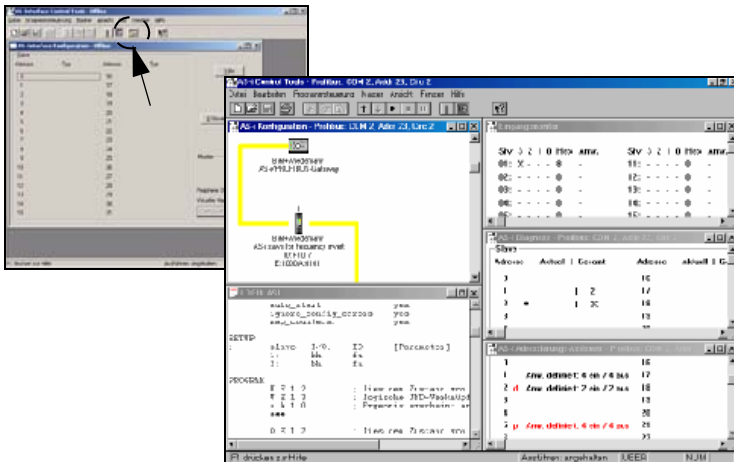

A very easy approach to configure the AS-i circuit is connecting each AS-i slave to the line and setting the AS-i slave address one after the other. After that press the button "Store configuration" to adopt the detected AS-i circuit to the AS-i master as projected data.

Furthermore you can use the **AS-i Address Assistant**. This tool automatically changes the address of an AS-i slave to the desired address after connecting the slave to the AS-i line. The desired AS-i configuration can be created offline before and then be stored to a file. When building up the plant you only have to connect the AS-i slaves to the AS-i line one after the other.

Further descriptions to all features of the software can be obtained from the integrated help.

13 Appendix: Codes indicated by the Display

In the basic state of the configuration mode, the display shows the addresses of all detected slaves at a rate of two per second one after the other. A blank display indicates that the *LDS* is empty, no slaves were detected.

In the basic state of the protected operating mode, the display is either blank or displays the address of a faulty assignment (see chapter 6.1.1).

During manual address programming, the slave address display has a different meaning (see chapter 6.2.7).

All displayed numbers bigger than 31 which can not be interpreted as a slave address are status or error messages of the master. They have the following meanings:

39	Advanced AS-i diagnostics: After pressing the 'set'-button a short-time AS-i power failure occurred.
40	The AS-i master is in offline phase.
41	The AS-i master is in detection phase.
42	The AS-i master is in activation phase.
43	The AS-i master starts the normal operating mode.
70	Hardware error: The AS-i master's EEPROM cannot be written.
71	Wrong PIC-type.
72	Hardware error: wrong PIC-processor.
73	Hardware error: wrong PIC-processor.
74	Checksum error in the EEPROM.
75	Error in the internal RAM.
76	Error in the external RAM.
77	AS-i control software error: Stack overflow (AS-i control II)
78	AS-i control software error: Checksum error in the control program.
80	Error while attempting to exit the configuration mode: A slave with address zero exists.
81	General error while changing a slave address.

82	The front panel operation is blocked. Until repowering-up the device can only be accessed from the host via the interface.
83	Program reset of the AS-i Control programm: The AS-i Control programm is being read out of EEPROM and copied into the RAM.
88	Display test while starting up the AS-i master
90	Error while changing a slave address in protected operating mode: No slave with address 0 existing.
91	Error while changing slave address: Target address is already used.
92	Error while changing slave address: New address could not be set.
93	Error while changing slave address: New address could only be stored volatily in the slave.
94	Error while changing the slave address in protected operating mode: Slave has wrong configuration data.
95	The error 95 is caused by a superfluous slave and not by a missing slave. That is why the slave address is occupied by this superfluous slave. (In the protected mode the slave addresses which caused any configuration error can be displayed by pressing the SET button. AS-i master without graphical display are not able to differentiate between a missing slave, an incorrect slave or a redundant slave. All incorrect addresses are displayed. By pressing the SET button 5 sec. the displayed address starts to flash. Pressing the SET button again the master attempts to program the slave at the address 0 to the incorrect address.)

14 Appendix: Installation instructions

14.1 **1 Master**
VBG-DN-K20-D
190324

AS-i 3.0 DeviceNet-Gateway in Edelstahl
AS-i 3.0 DeviceNet Gateway in Stainless Steel
Passerelle AS-i 3.0 DeviceNet en boîtier inox
Gateway AS-i 3.0 DeviceNet d'acciaio inox
Pasarela AS-i 3.0 DeviceNet en acero inoxidable

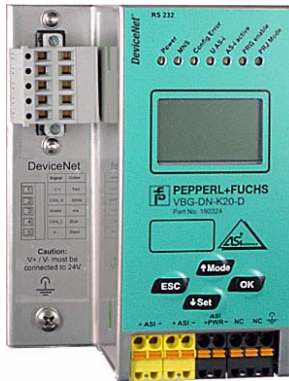

Dokumentation AS-i 3.0 DeviceNet-Gateway (deutsch)
Documentation AS-i 3.0 DeviceNet Gateway (english)



Die Geräte dürfen nur von Fachpersonal aufgebaut, angeschlossen und in Betrieb genommen werden! / Only qualified staff is allowed to mount, connect and set up the modules! / Les modules ne doivent être montés, raccordés et mis en service que par du personnel qualifié! / Gli apparecchi possono essere montati, collegati e messi in funzione soltanto da personale specializzato! / Los aparatos sólo pueden ser montados, conectados y puestos en servicio por personal técnico especializado!

14.1.1 Dimensions

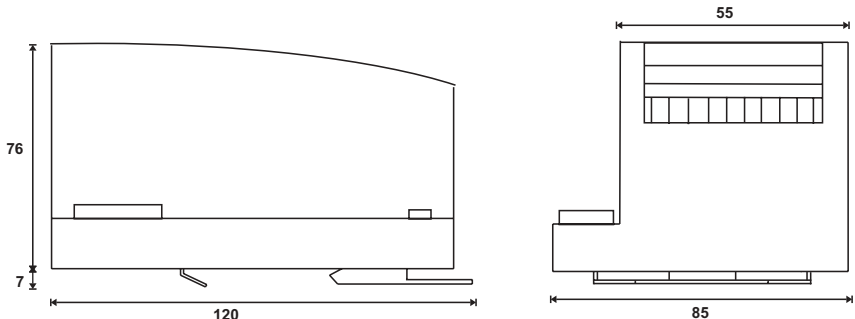

Issue date - 20.4.2007

14.1.2 Front view and connections

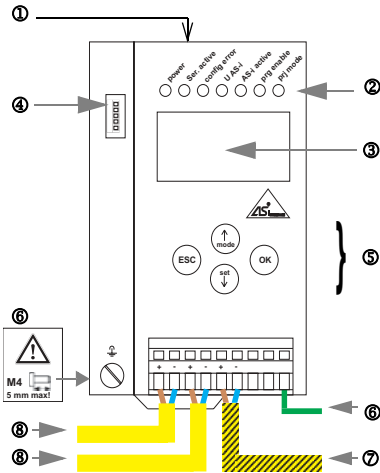

- ⑦ AS-i-Netzteil/AS-i power supply/Alimentation AS-i/Alimentatore AS-i/Alimentación AS-i
- ⑧ AS-i-Kreis/AS-i circuit/Bus AS-i/Circuito AS-i /Circuito AS-i

- ① RS 232-Anschluss
- ② LED-Statusanzeige
- ③ LCD-Anzeige
- ④ CAN-Anschluss
- ⑤ Tasten für Handbedienung
- ⑥ Erde

- ① RS 232 connection
- ② LED status display
- ③ LCD display
- ④ CAN connection
- ⑤ Buttons for hand operation
- ⑥ Ground

- ① Raccordement RS 232
- ② Affichage d'état DEL
- ③ Affichage LCD
- ④ Raccordement CAN
- ⑤ Boutons pour commande manuelle
- ⑥ Terre

- ① Collegamento RS 232
- ② Visualizzazione di stato LED
- ③ Visualizzazione LCD
- ④ Collegamento CAN
- ⑤ Pulsanti per le impostazioni manuali
- ⑥ Terra

Signal	Color
V+	rot/ red/ rouge/ rosso/ rojo
CAN_H	weiss/ white/ blanc/ bianco/ blanco
Shield	n/a
CAN_L	blau/ blue/ bleu/ blu/ azul
V-	schwarz/ black/ noir/ nero/ negro

Temperature rating for cable: 60/75°C
Use copper conductors only
1 x 0.5 - 1.5 mm² (16AWG/kcmil: min. 24/max. 12)
Operating temperature: 0°C ... +55°C

Hinweis/Hint/Remarque/Indicazione/Nota

Am Kabel für das Netzteil dürfen keine Slaves oder Repeater angeschlossen werden.
Am Kabel für den AS-i-Anschluss dürfen keine AS-i-Netzteile oder weitere Master angeschlossen werden.
V+ / V- muss an 24V angeschlossen werden.

At the cable for power supply no slaves or repeaters may be attached.

At the cable for AS-i circuit no power supplies or further masters may be attached.
V+ / V- must be connected to 24V.

Au câble pour l'alimentation aucun esclave ou répéteur ne peut être raccordé.

Au câble pour le circuit AS-i aucune alimentation ou autre maître ne peut être raccordé.
V+ / V- nécessite une alimentation de 24V.

Al cavo per l'alimentazione nessun slave o ripetitore può essere fissato.

Al cavo per il circuito AS-i nessun alimentatore o altro master può essere fissato.
V+ / V- deve essere collegato a 24V.

En el cable de la alimentación AS-i no se deben conectar esclavos o repetidores.

En el cable del circuito AS-i no se debe conectar ninguna fuente de poder AS-i u otro master.
V+ / V- se deben conectar a 24V.

- ① Conexión RS 232
- ② LED visualización
- ③ Display LCD
- ④ Conexión CAN
- ⑤ Teclas para accionamiento manual
- ⑥ Tierra

14.1.3 Startup

14.1.3.1 Switching to advanced display mode

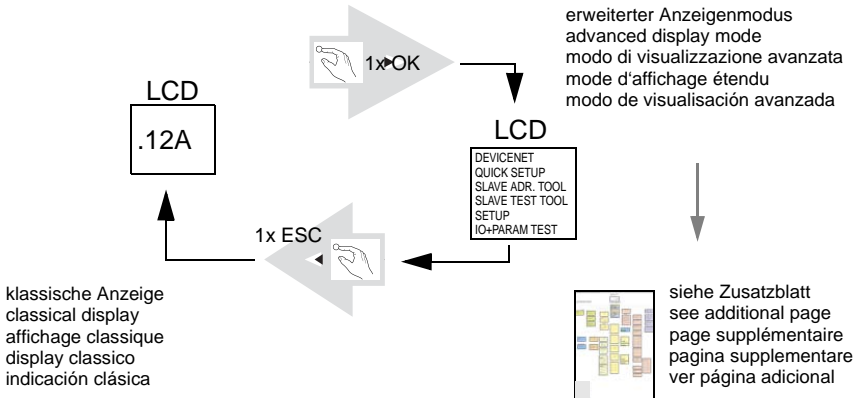

14.1.3.2 Setting the MAC ID

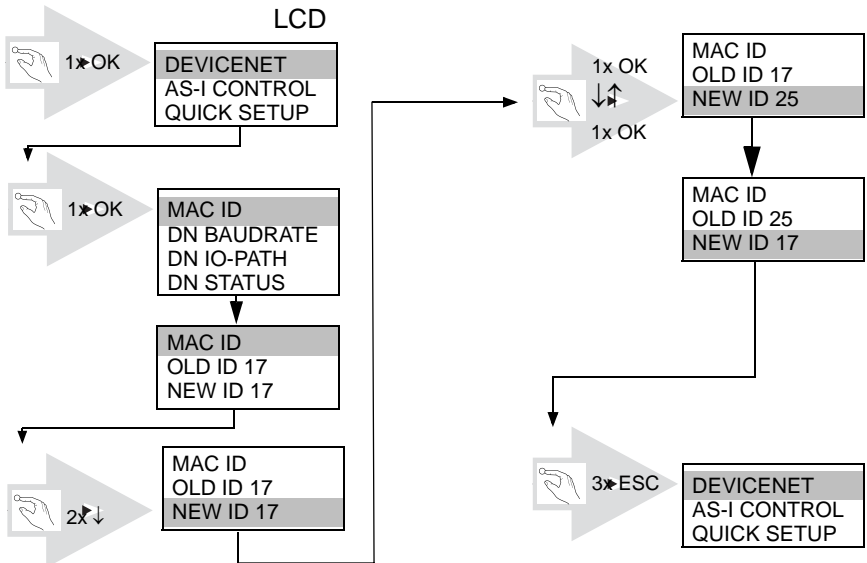

14.1.3.3 Setting the Baud Rate

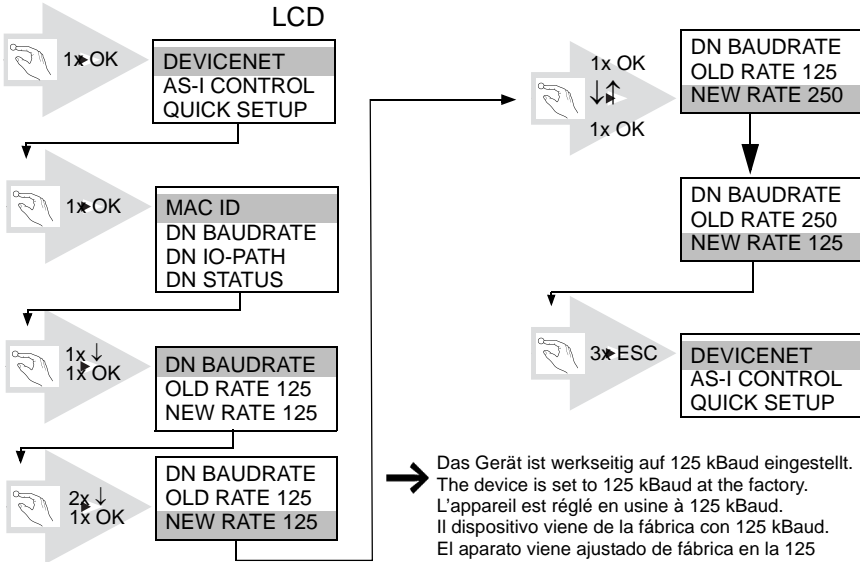

14.1.4 Connecting AS-i Slaves

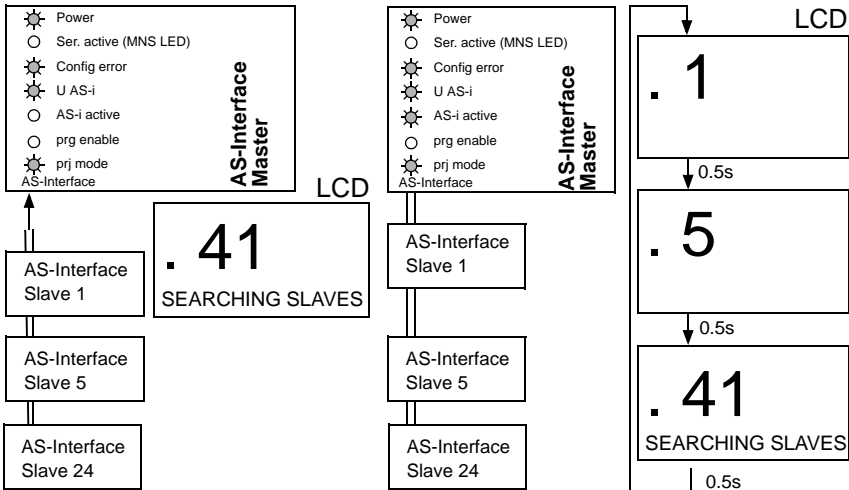

Issue date - 20.4.2007

14.1.5 Quick Setup

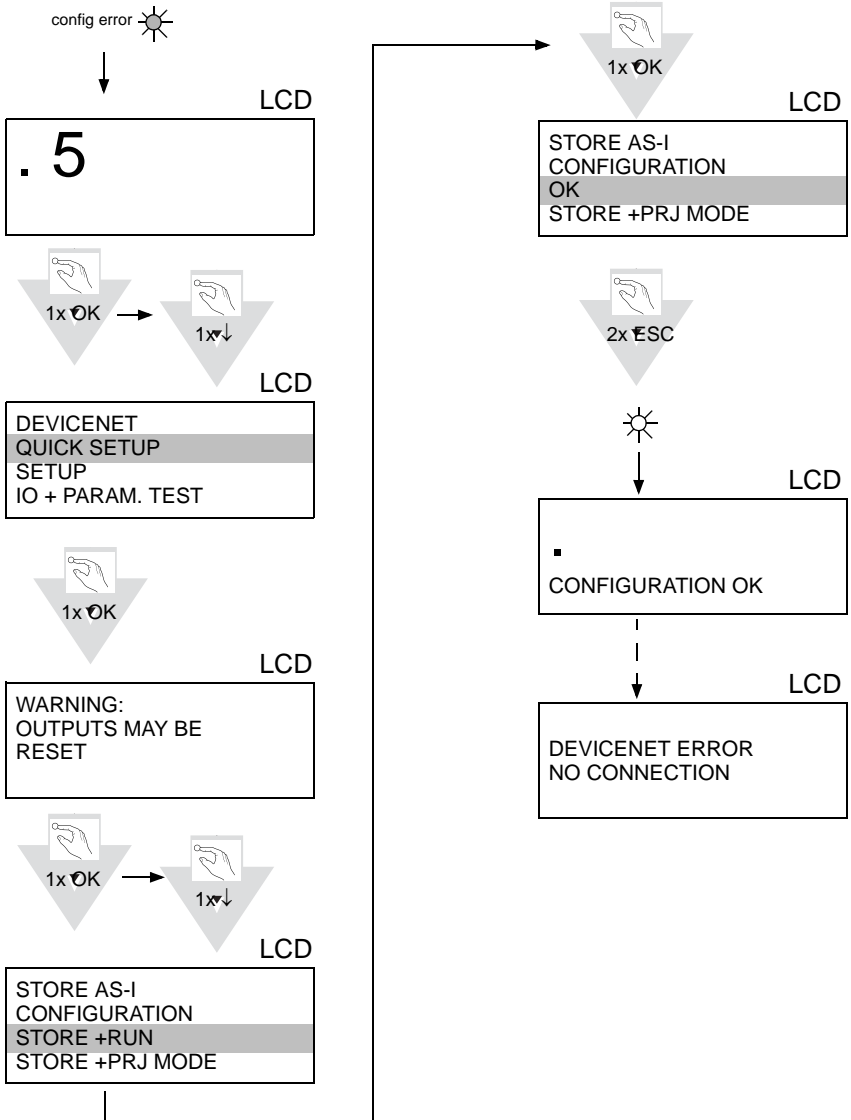

14.1.6 Error tracing

14.1.6.4 Faulty slaves

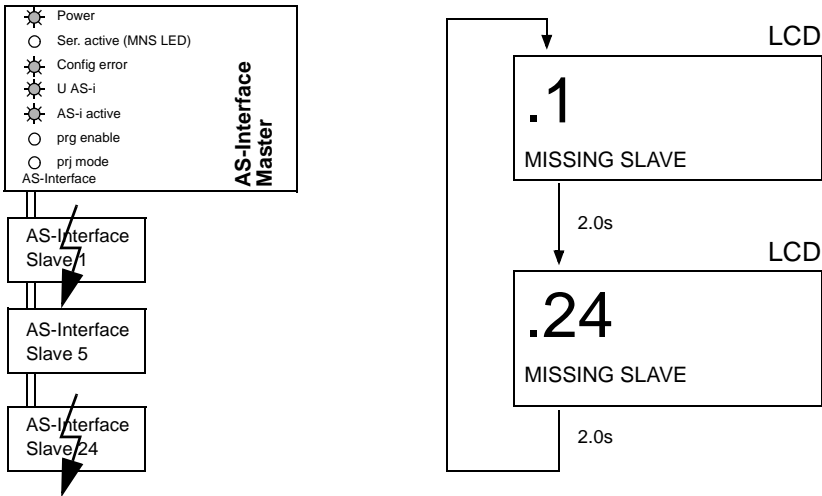

14.1.6.5 Error display (last error)

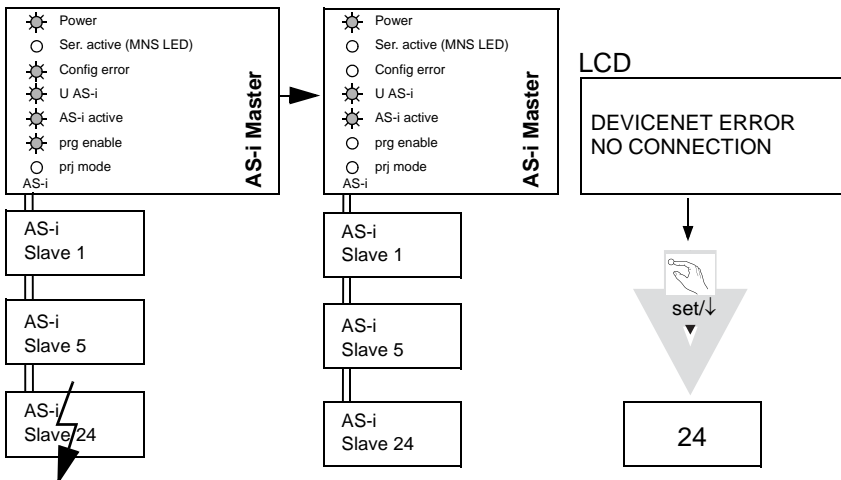

14.1.7 Addressing

14.1.7.6 Programming slave 2 to address 6

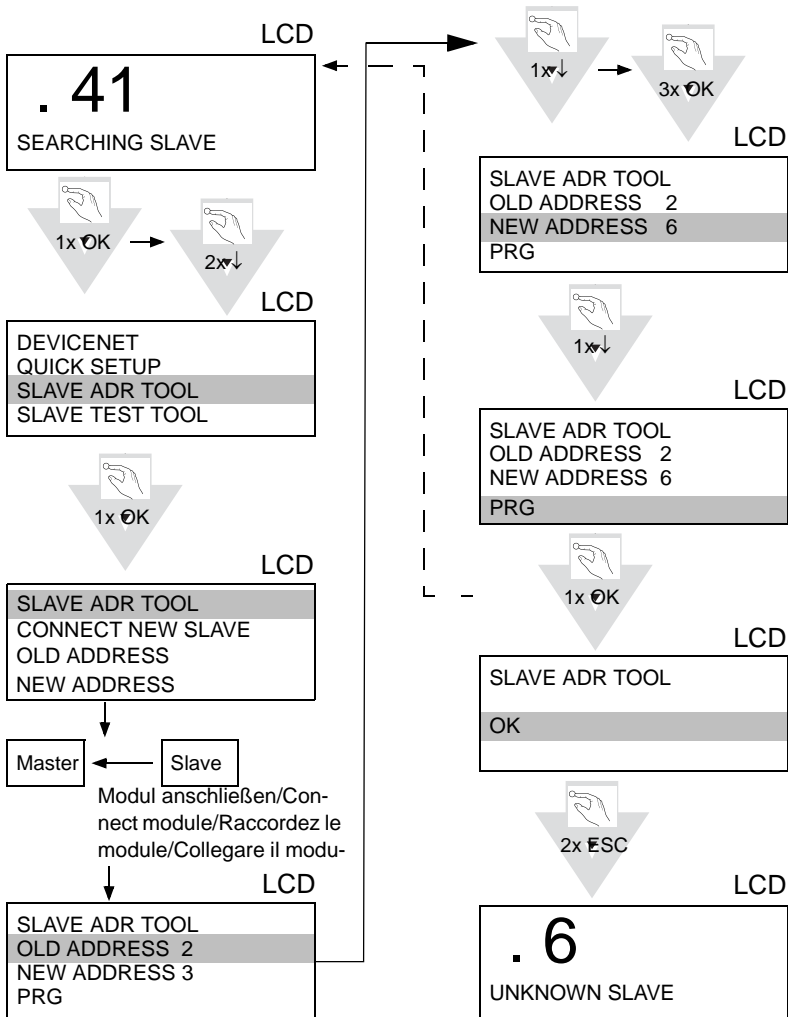

14.1.8 Montage

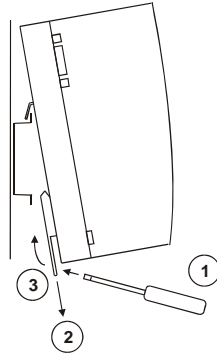
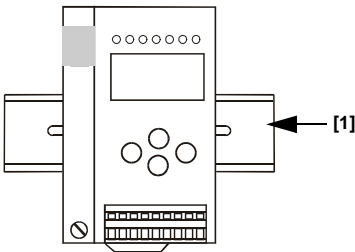

on mounting plate with 35 mm top-hat rail ①

14.1.9 ZubehörAccessories

- PC-Software "AS-i-Control-Tools" mit seriellem Kabel zum Anschluss der AS-i Master in Edelstahl / Software "AS-i-Control-Tools" with serial cable for connection of the AS-i Master in Stainless Steel / Logiciel "AS-i-Control-Tools" avec câble série pour la connexion du maître AS-i en acier inox / Software PC "AS-i-Control-Tools" con cavo seriale per il collegamento del master AS-i d'acciaio inox / Software de PC "AS-i-Control-Tools" con cable serial para la conexión del Maser AS-i en acero inoxidable.
- DeviceNet-Mastersimulator / DeviceNet-Master Simulator / Simulateur maître DeviceNet / Simulatore master DeviceNet / DeviceNet-Simulador principal.
- Kabel für AS-i-CAN-Gateways / Cable for AS-i Gateways with CAN interface / Câble pour passerelle AS-i/CAN / Cavo per gateway AS-i / CAN / cable para AS-i CAN interfaz.
- AS-i Netzteil 4 A / AS-i Power Supply 4 A / Alimentation AS-i 4 A / Alimentazione AS-i 4 A / Fuente de poder AS-i 4 A.

**14.2 2 Master
VBG-DN-K20-DM
D # 190325**

**AS-i 3.0 DeviceNet-Gateway in Edelstahl
AS-i 3.0 DeviceNet Gateway in Stainless Steel
Passerelle AS-i 3.0 DeviceNet en boîtier inox
Gateway AS-i 3.0 DeviceNet d'acciaio inox
Pasarela AS-i 3.0 DeviceNet en acero inoxidable**



Dokumentation AS-i 3.0 DeviceNet-Gateway (deutsch)
Documentation AS-i 3.0 DeviceNet Gateway (english)



Attention

Die Geräte dürfen nur von Fachpersonal aufgebaut, angeschlossen und in Betrieb genommen werden! / Only qualified staff is allowed to mount, connect and set up the modules! / Les modules ne doivent être montés, raccordés et mis en service que par du personnel qualifié! / Gli apparecchi possono essere montati, collegati e messi in funzione soltanto da personale specializzato! / Los aparatos sólo pueden ser montados, conectados y puestos en servicio por personal técnico especializado!

14.2.1 Dimensions

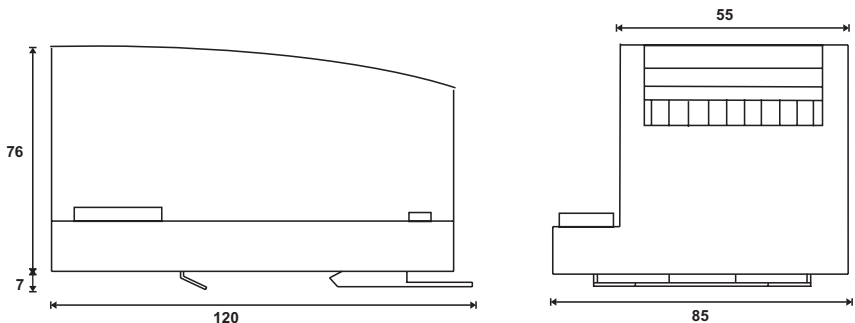

Issue date - 20.4.2007

14.2.2 Front view and connections

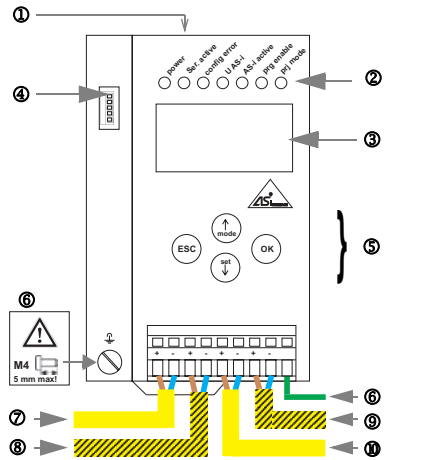

- ⑦ AS-i-Kreis 1/AS-i circuit 1/Bus AS-i 1/AS-i Circuito 1/ AS-i Circuito 1
 - ⑧ AS-i-Netzteil Kreis 1/AS-i power supply circuit 1/Alimentation bus AS-i 1/Alimentazione AS-i circuito 1/Alimentación AS-i circuito 1
 - ⑨ AS-i-Netzteil Kreis 2/AS-i power supply circuit 2/Alimentation bus AS-i 2/Alimentazione AS-i circuito 2/Alimentación AS-i circuito 1
 - ⑩ AS-i-Kreis 2/AS-i circuit 2/Bus AS-i 2/ Circuito AS-i2/ Circuito AS-i 2
- Operating temperature: 0°C ... +55°C

- | | |
|---|---|
| <ul style="list-style-type: none"> ① RS 232-Anschluss ② LED-Statusanzeige ③ LCD-Anzeige ④ CAN-Anschlüsse ⑤ Tasten für Handbedienung ⑥ Erde | <ul style="list-style-type: none"> ① RS 232 connection ② LED status display ③ LCD display ④ CAN connection ⑤ Buttons for hand operation ⑥ Ground |
| <ul style="list-style-type: none"> ① Raccordement RS 232 ② Affichage d'état DEL ③ Affichage LCD ④ Raccordement CAN ⑤ Boutons pour commande manuelle ⑥ Terre | <ul style="list-style-type: none"> ① Collegamento RS 232 ② Visualizzazione di stato LED ③ Visualizzazione LCD ④ Collegamento CAN ⑤ Pulsanti per le impostazioni manuali ⑥ Terra |

	Signal	Color
④	1	V+ rot/ red/ rouge/ rosso/ rojo
	2	CAN_H weiss/ white/ blanc/ bianco/ blanco
	3	Shield n/a
	4	CAN_L blau/ blue/ bleu/ blu/ azul
	5	V- schwarz/ black/ noir/ nero/ negro

Temperature rating for cable: 60/75°C
Use copper conductors only
1 x 0.5 - 1.5 mm² (16AWG/kcmil: min. 24/max. 12)

Hinweis/Hint/Remarque/Indicazione/Nota

AS-i-Kreis 1 und 2 werden aus AS-i-Netzteilen versorgt. Am Kabel für das Netzteil dürfen keine Slaves oder Repeater angeschlossen werden.
Am Kabel für den AS-i-Anschluss dürfen keine AS-i-Netzteile oder weitere Master angeschlossen werden.
V+ / V- muss an 24V angeschlossen werden.

AS i circle 1 and 2 are supplied from AS-i power supplies. At the cable for power supply no slaves or repeaters may be attached.
At the cable for AS-i circuit no power supplies or further masters may be attached.
V+ / V- must be connected to 24V.

Les bus AS-i 1 et 2 sont alimentés à partir de l'alimentation AS-i.
Au câble pour l'alimentation aucun esclave ou répéteur ne peut être raccordé.
Au câble pour le circuit AS-i aucune alimentation ou autre maître ne peut être raccordé.
V+ / V- nécessite une alimentation de 24V.

I circuiti AS-i 1 e 2 sono alimentati dall'alimentatore AS-i.
Al cavo per l'alimentazione nessun slave o ripetitore può essere fissato.
Al cavo per il circuito AS-i nessun alimentatore o altro master può essere fissato.
V+ / V- deve essere collegato a 24V.

Los circuitos AS-i 1 y 2 son alimentados de la fuente de poder AS-i.
En el cable de la alimentación AS-i no se deben conectar esclavos o repetidores.
En el cable del circuito AS-i no se debe conectar ninguna fuente de poder AS-i u otro master.
V+ / V- se deben conectar a 24V.

- | | |
|---|---|
| <ul style="list-style-type: none"> ① Conexión RS 232 ② LED visualización ③ Display LCD ④ Conexión CAN ⑤ Teclas para accionamiento manual ⑥ Tierra | <ul style="list-style-type: none"> ① Conexión RS 232 ② LED visualización ③ Display LCD ④ Conexión CAN ⑤ Teclas para accionamiento manual ⑥ Tierra |
|---|---|

Issue date - 20.4.2007

14.2.3 Startup

14.2.3.7 Switching to advanced display mode

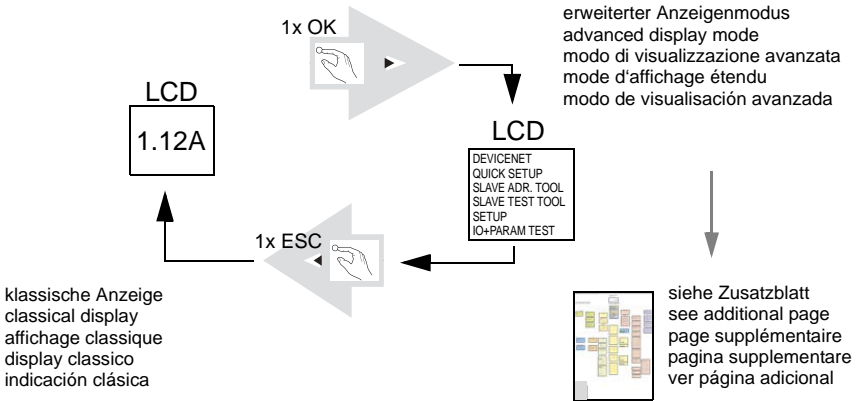

14.2.3.8 Setting the MAC ID

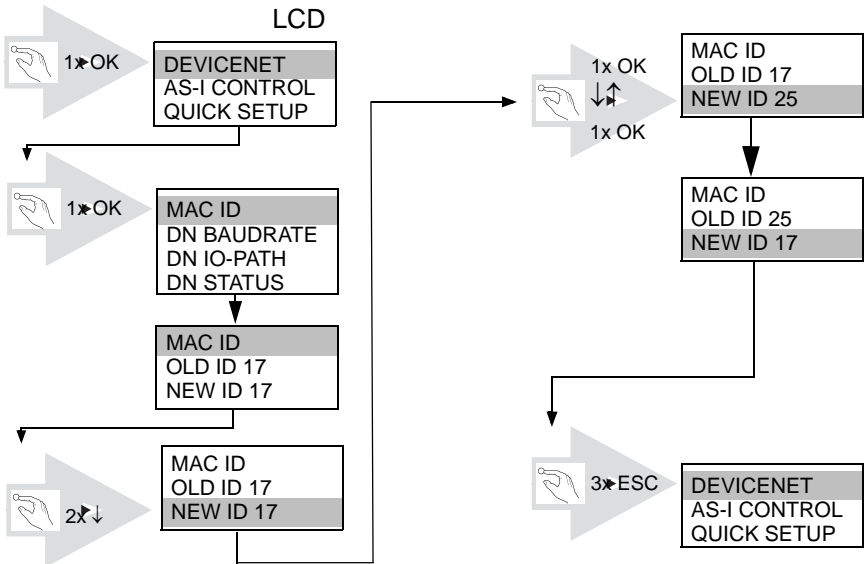

Issue date - 20.4.2007

14.2.3.9 Setting the Baud Rate

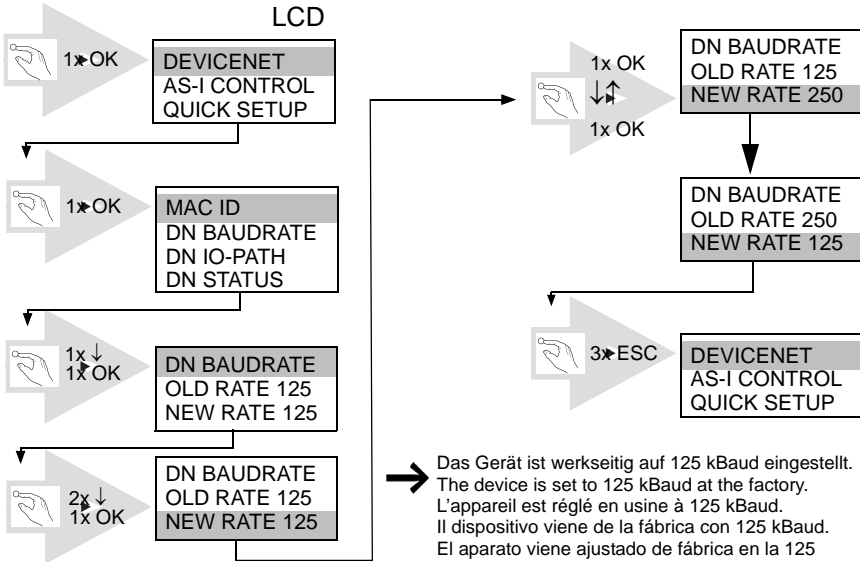

14.2.4 Connecting AS-i Slaves

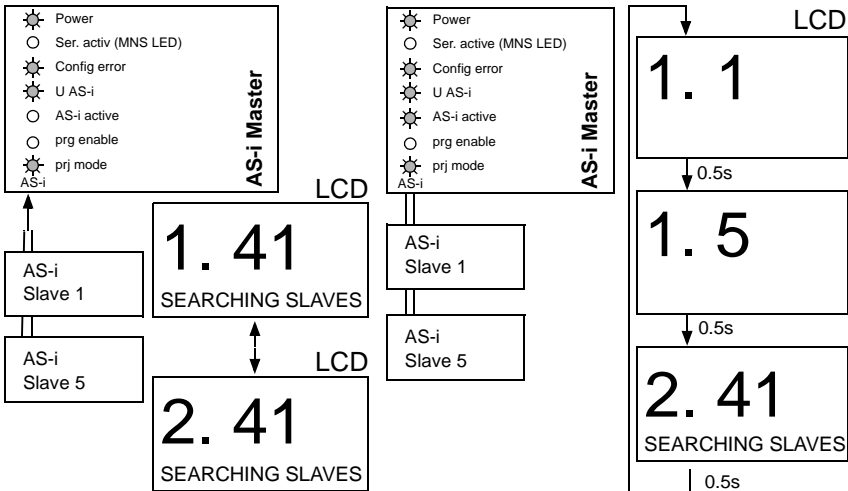

14.2.5 Quick Setup

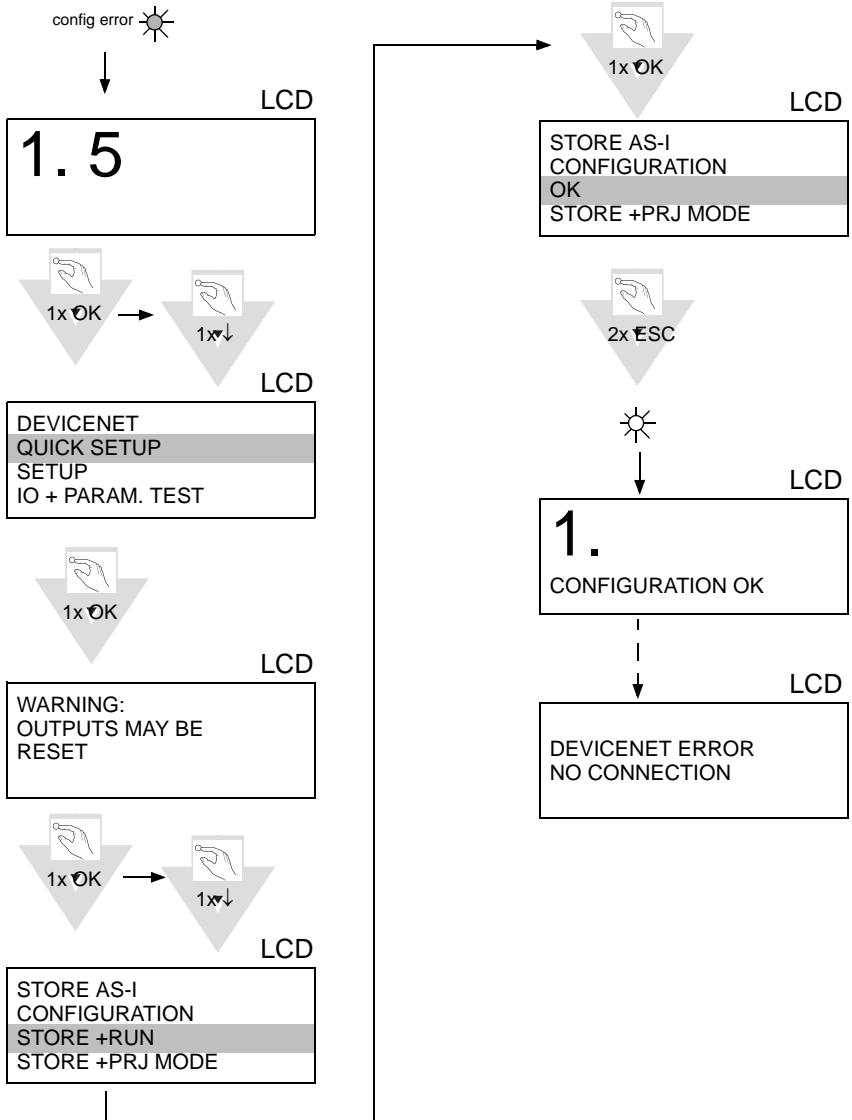

14.2.6 Error tracing

14.2.6.10 Faulty slaves



14.2.6.11 Error display (last error)

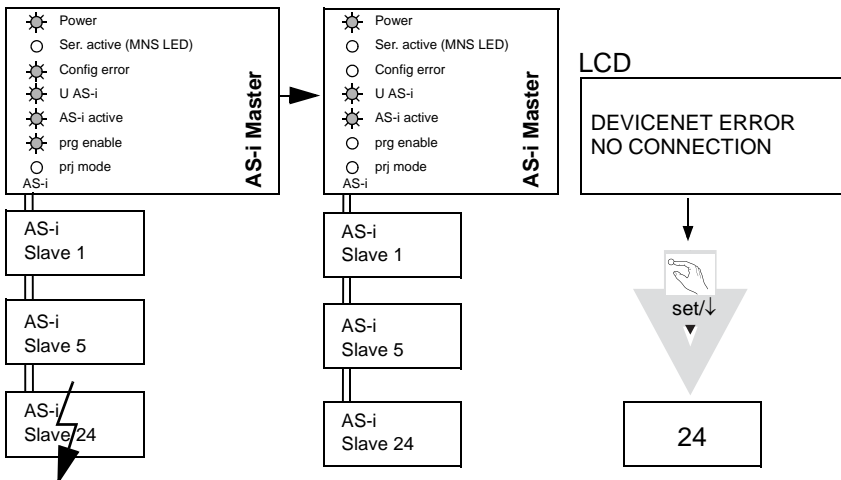

14.2.7 Addressing

14.2.7.12 Programming slave 2 to address 6

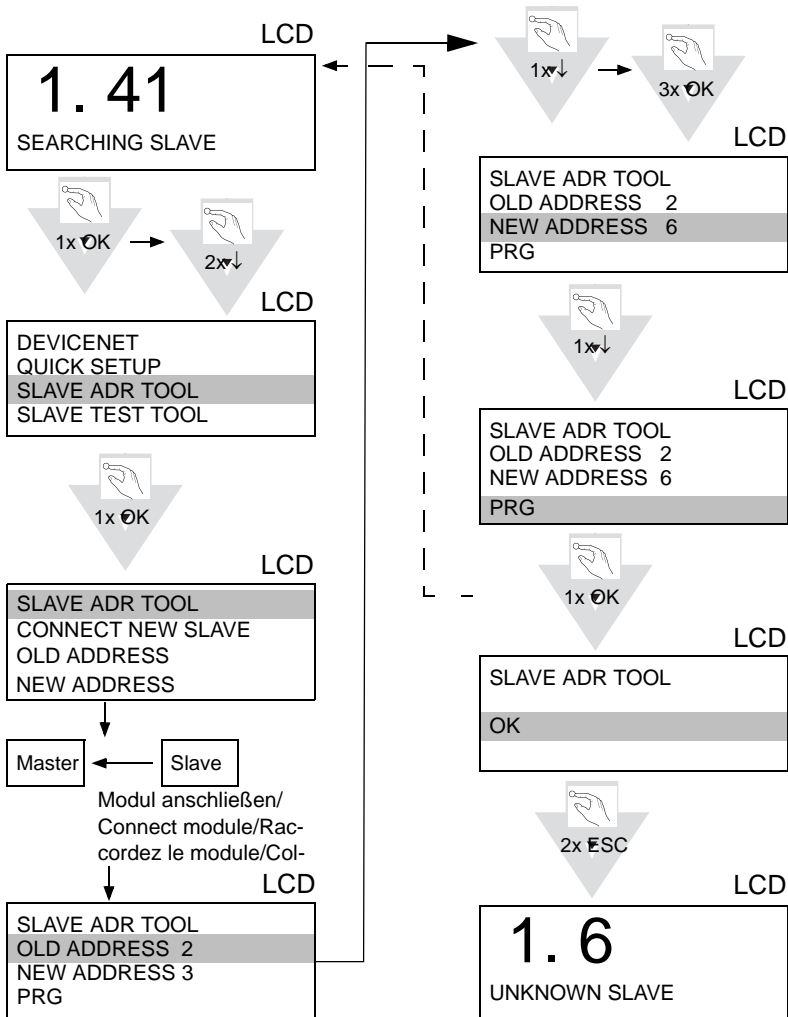

14.2.8 Montage

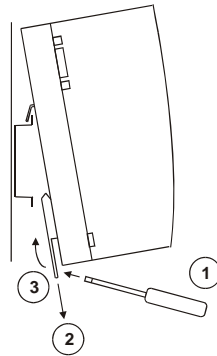
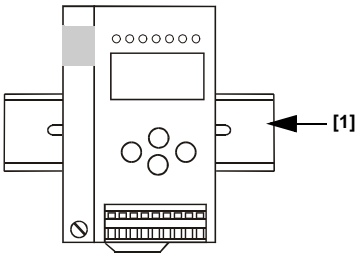

on mounting plate with 35 mm top-hat rail ①

14.2.9 Accessories

- PC-Software "AS-i-Control-Tools" mit seriellem Kabel zum Anschluss der AS-i Master in Edelstahl / Software "AS-i-Control-Tools" with serial cable for connection of the AS-i Master in Stainless Steel / Logiciel "AS-i-Control-Tools" avec câble série pour la connexion du maître AS-i en acier inox / Software PC "AS-i-Control-Tools" con cavo seriale per il collegamento del master AS-i d'acciaio inox / Software de PC "AS-i-Control-Tools" con cable serial para la conexión del Maser AS-i en acero inoxidable.
- DeviceNet-Mastersimulator / DeviceNet-Master Simulator / Simulateur maître DeviceNet / Simulatore master DeviceNet / DeviceNet-Simulador principal.
- Kabel für AS-i-CAN-Gateways / Cable for AS-i Gateways with CAN interface / Câble pour passerelle AS-i/CAN / Cavo per gateway AS-i / CAN / cable para AS-i CAN interfaz.
- AS-i Netzteil 4 A / AS-i Power Supply 4 A / Alimentation AS-i 4 A / Alimentazione AS-i 4 A / Fuente de poder AS-i 4 A.

15 Appendix: integration into Rockwell PLC

This chapter shows exemplarily the integration of an AS-i/DeviceNet Gateway into a Rockwell PLC.

The example exists out of a Rockwell PLC, a SDN 1756 card as DeviceNet scanner and an AS-i 3.0 DeviceNet Gateway with a connected AS-i circuit as well as the software package „RSNetWorx for DeviceNet“.

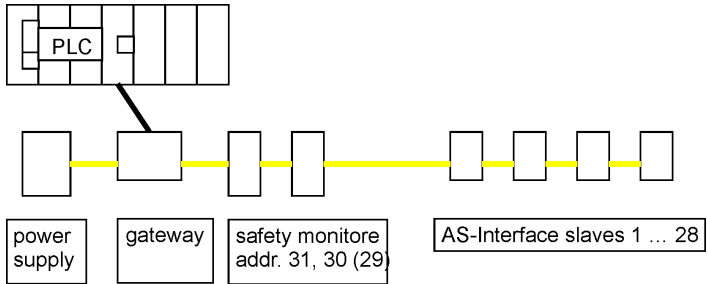

Configuration example (scheme)

For integration of the gateway into a Rockwell PLC it is necessary first to configure the AS-i 3.0 DeviceNet gateway (adjusting the node address and the DeviceNet baudrate). After this configuration the gateway can be integrated into the PLC.

15.1 Configuration of the AS-i DeviceNet Gateway

15.1.1 Adjusting the Node Address in the DeviceNet Circuit

- Connect the gateway to AS-i power supply.
- Connect the ASI-network cable(s) to the gateway, switch on AS-i power supply.
- Call the configuration menu of the gateway by pressing the "OK" button.

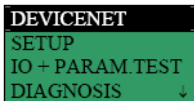

- Press the "OK" button.

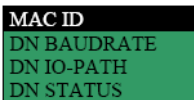

- Press the "OK" button.

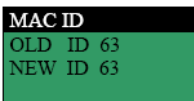

- Change to line "NEW ID" by pressing the button "set/↓" twice.

```
MAC ID
OLD ID 63
NEW ID 63
```

- Press the "OK" button.
- Change the first digit by pressing the buttons "set/↓" or "mode/↑".
- Press the "OK" button.
- Change the second digit by pressing the buttons "set/↓" or "mode/↑".
- Press the "OK" button.

```
MAC ID
OLD ID 02
NEW ID 02
```

(example)

- To leave the configuration menu, press three times the "ESC" button.
Now the gateway works with a new ID.

15.1.2 Adjusting the DeviceNet Baudrate

- Call the configuration menu of the gateway by pressing the "OK" button.

```
DEVICENET
SETUP
IO + PARAM TEST
DIAGNOSIS ↓
```

- Press the "OK" button.

```
MAC ID
DN BAUDRATE
DN IO-PATH
DN STATUS
```

- Change to line "DN BAUDRATE" by pressing the button "set/↓".

```
MAC ID
DN BAUDRATE
DN IO-PATH
DN STATUS
```

- Press the "OK" button.

```
DN BAUDRATE
OLD RATE 125
NEW RATE 125
```

- Change to line "NEW RATE" by pressing the button "set/↓" twotimes.

```
DN BAUDRATE
OLD RATE 125
NEW RATE 125
```

- Press the "OK" button.
- Change the baudrate by pressing the buttons "set/↓" or "mode/↑".
- To acknowledge your choice, press the "OK" button.

```
DN BAUDRATE
OLD RATE 500
NEW RATE 500
```

(example)

- To leave the configuration menu, press three times the "ESC" button.
Now the gateway works with a new baudrate.

15.1.3 Adjusting the DeviceNet I/O Path

- Call the configuration menu of the gateway by pressing the "OK" button.

```
DEVICENET
SETUP
IO + PARAM.TEST
DIAGNOSIS ↓
```

- Press the "OK" button.

```
MAC ID
DN BAUDRATE
DN IO-PATH
DN STATUS
```

- Change to line "DN IO-PATH" by pressing the button "set/↓" twice.

```
MAC ID
DN BAUDRATE
DN IO-PATH
DN STATUS
```

- Press the "OK"-button.

```
DN IO-PATH
OLD P:100 C:136
NEW P:100 C:136
```

- Change to line "NEW" by pressing the button "set/↓" twice.

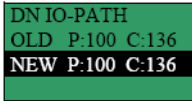

- Press the "OK" button.
- Change the instance ID (P) by pressing the buttons "set/↓" or "mode/↑".
- To acknowledge your choice, press the "OK" button.
- Change the complementary ID (C) by pressing the buttons "set/↓" or "mode/↑".
- To acknowledge your choice, press the "OK" button.

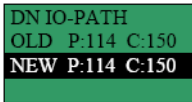

(example)

- To leave the configuration menu, press three times the "ESC" button.
Now the gateway works with a new I/O path.

15.2 Configuring the AS-i Gateway in the DeviceNet Scanner

15.2.1 Configuring the AS-i Gateway in the DeviceNet Scanner by using RSLinx

- Open RSLinx.

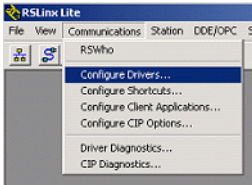

- "Communications" → "Configure Drivers ...".

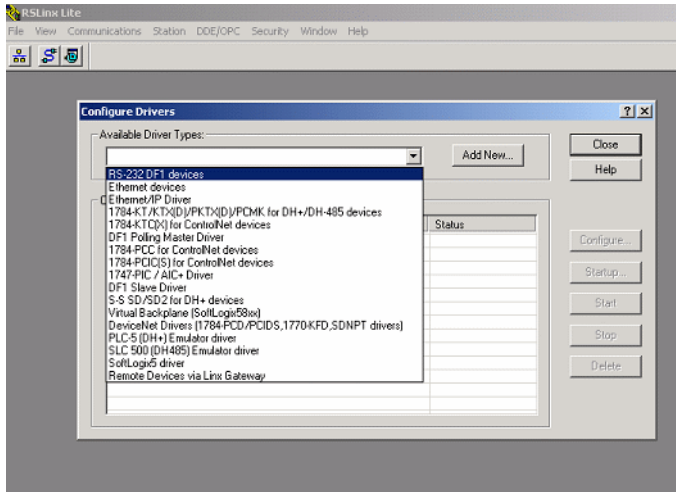

- Select the driver you need and click on "Add New ...".
- Configure the driver.

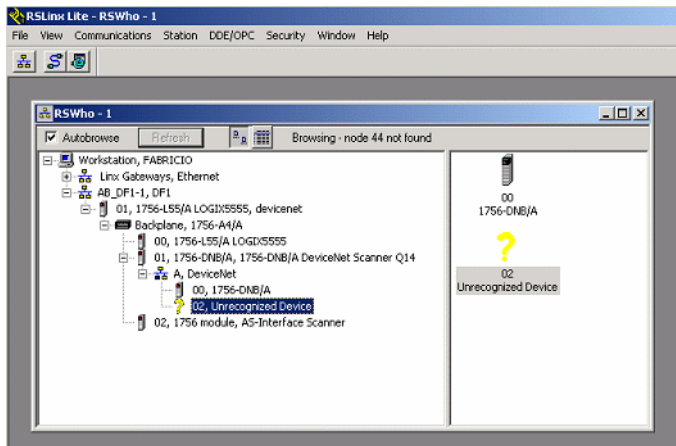

- Check in "RS-Who", whether your driver is configured or not. (If you find an unrecognized device, you have not integrated the EDS file. You can download the EDS file from the homepage of Bihl+Wiedemann - <http://www.bihl-wiedemann.de> → "Download Area" → "GSD and EDS Files"
 - EDS file for AS-i/DeviceNet Gateway with graphic display (single master), specification 2.1, art. no. BW1334"
 - EDS file for AS-i/DeviceNet Gateway with graphic display (double master), specification 2.1, art. no. BW1335"
 How to integrate the EDS file is shown in the next steps.)

15.2.2 Configuring the AS-i Gateway in the DeviceNet Scanner by using RSNNetWorx

- Open RSNNetWorx.
- Press F10.

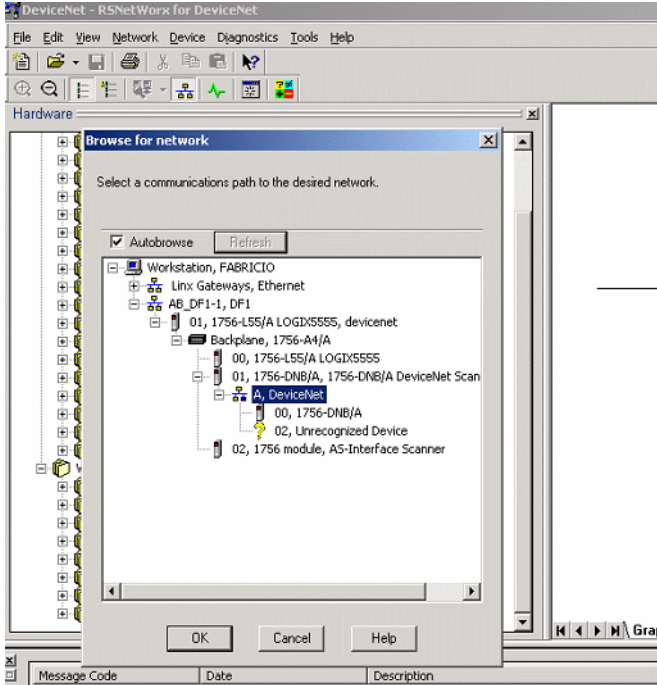

- Select your DeviceNet path and click on "OK".

15.2.2.1 Configuring the EDS File

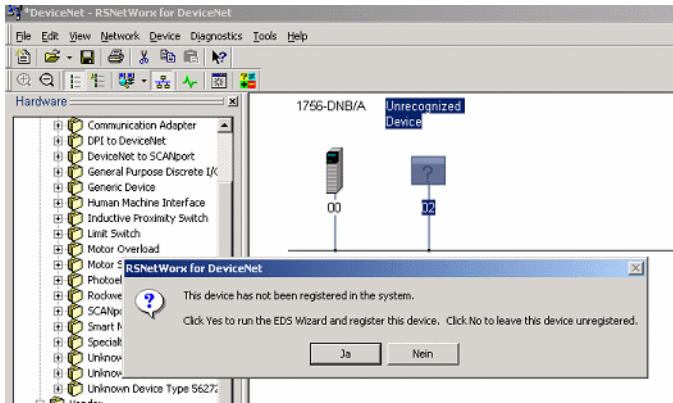

- Double-click on the "Unrecognized Device" and click "Yes" on the opening window.

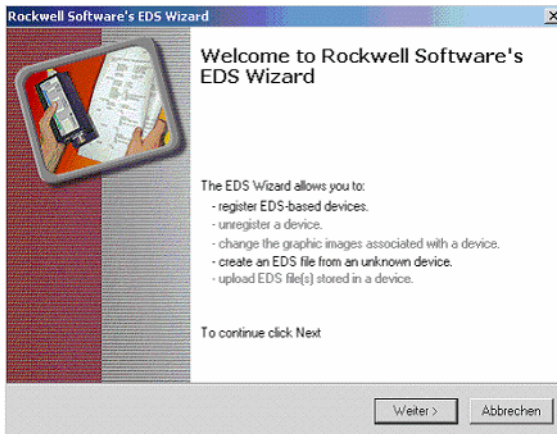

- Click "Next".

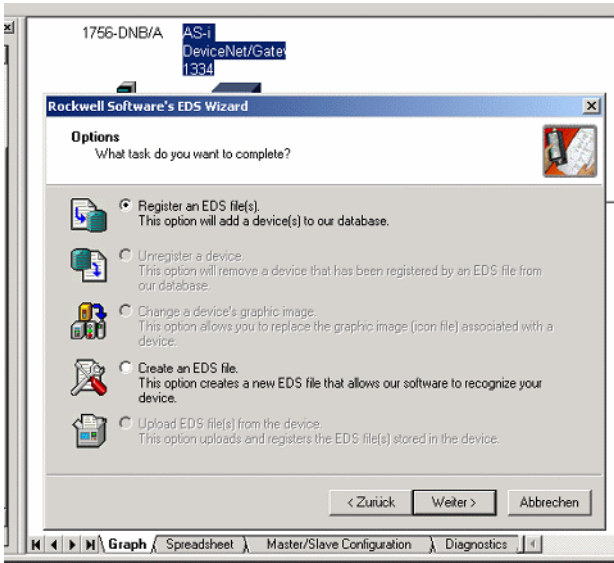

- Click "Register an EDS file(s)".
- Click "Next".

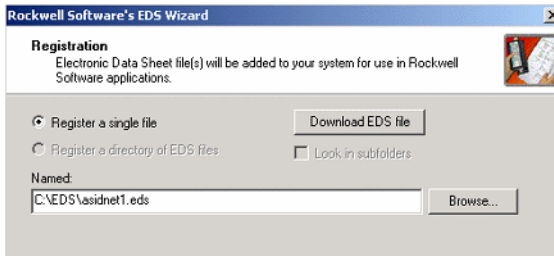

- Click on "Browse ..." and choose the folder, where you have stored the EDS file.
- Click "Next".

AS-i DeviceNet Gateway Appendix: integration into Rockwell PLC

- Ignore the warning and click "Next".

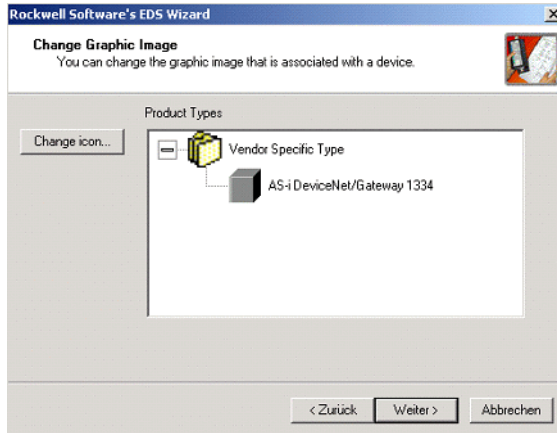

- Click twice "Next" and then "Finish".

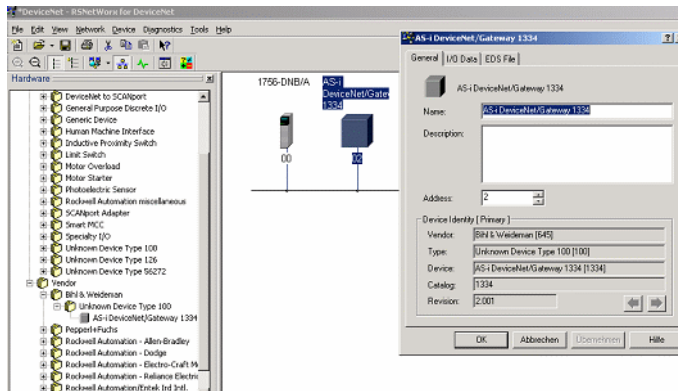

(Now your gateway is detected, if you double-click on the device, you can check information).

15.2.2.2 Configuring the Node Address and the Data Rate

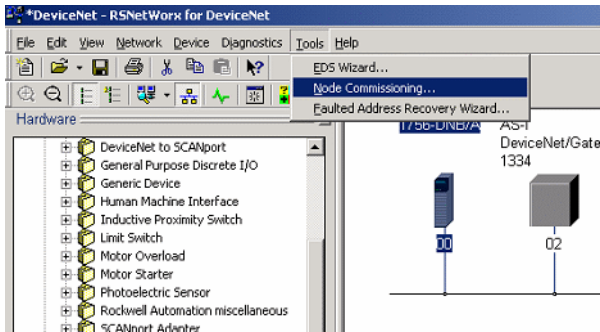

- Click on → "Tools" → "Node Commissioning ...".



- Click on "Browse ...".

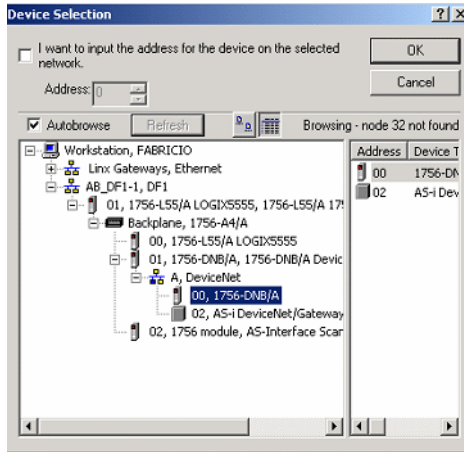

- Double-Click on your scanner-icon.

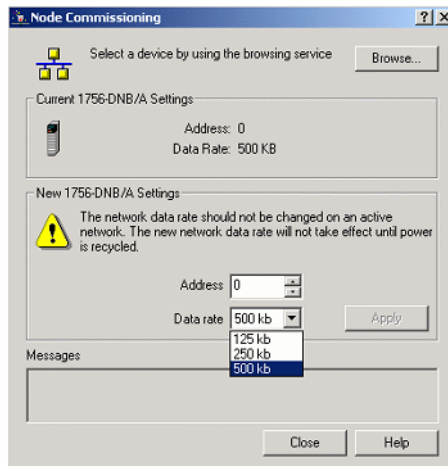

(Now you can change your address and data rate. Remember that the data rate of the DeviceNet scanner has to be the same as the baudrate of the AS-i scanner.).

15.2.2.3 Configuring the Scanlist

- Double-click on your DeviceNet scanner.

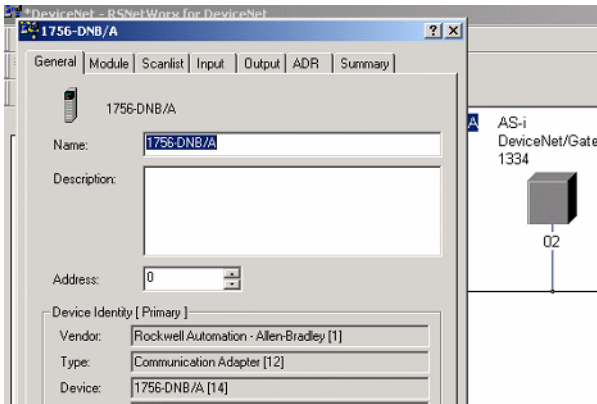

- Click on "Module".

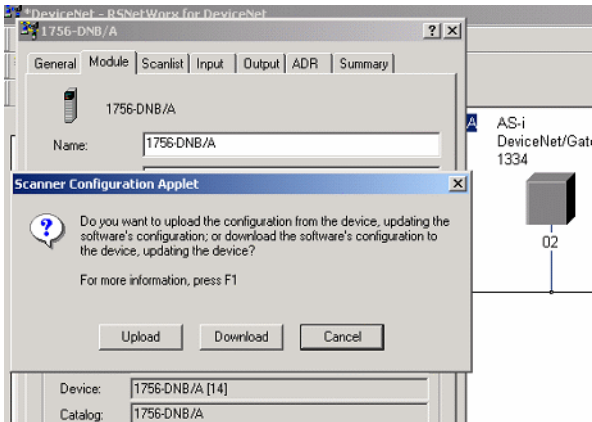

- Click on "Upload".

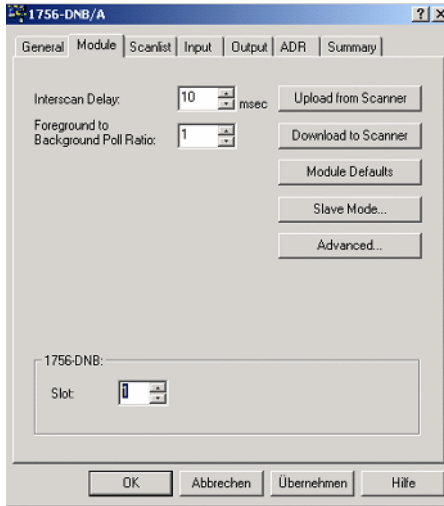

- Check the 1756-DNB slot number.
- Click on "Scanlist".

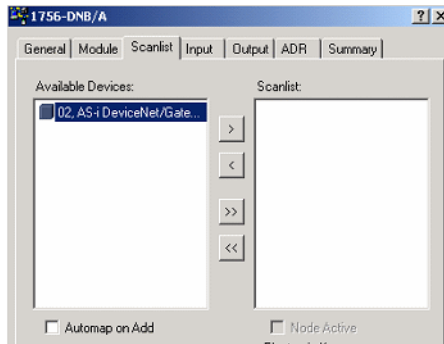

- Uncheck "Automap on Add".

- Click the double-arrow.

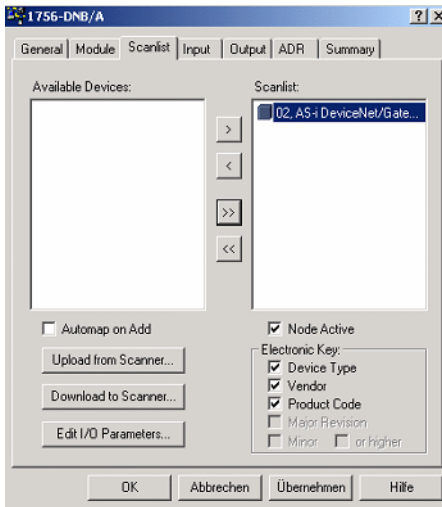

- Click on "Edit I/O Parameters ...".

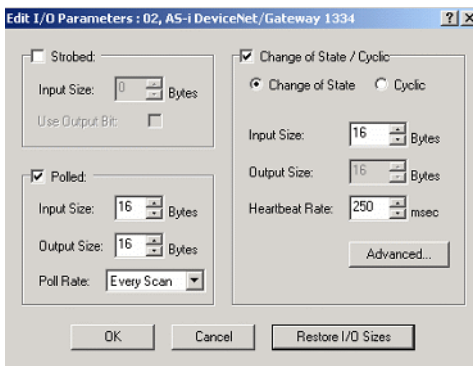

- Uncheck "Change of State / Cyclic".

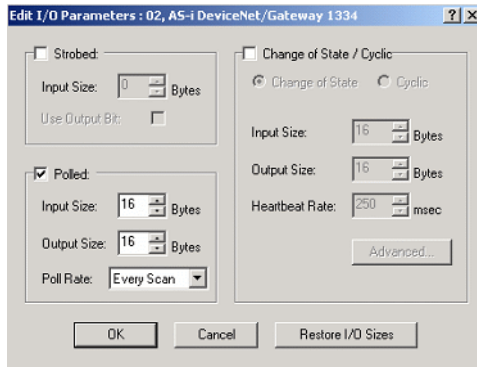

- Click "OK".

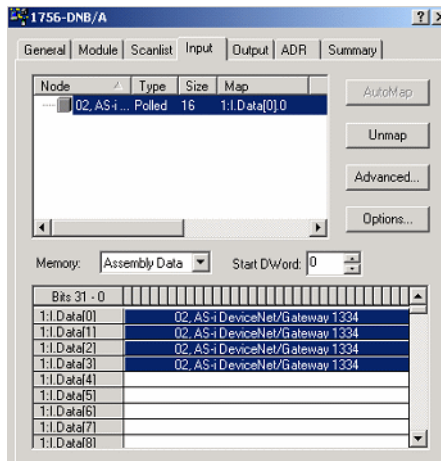

- Click on "Input".
- Check, where your input data is mapped.
- Click on "Output".
- Check, where your output data is mapped.
- Click "Apply".
- Download your changes.

Now your AS-i gateway is configured.

15.3 Configuring the I/O Path

If you like more I/O data mapped in the plc controller tags, you have to configure the AS-i gateway.

For example:

You like map the data of all binary AS-i slaves, the 16-bit data of slaves 29 ... 31 and the data of the long mailbox.

Choose the "Instance ID" 114 and the "Complementary ID" 150.

```
DN IO-PATH
OLD P:114 C:150
NEW P:114 C:150
```

(See chapter 15.1.3 of this documentation)

Adjust the input and output size by RSNetWorx.

("Input Size: 92 Bytes"; "Output Size: 92 Bytes").

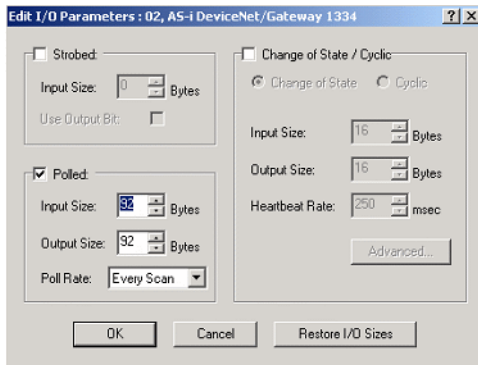

(See chapter 15.2.2.3 of this documentation)

Check where your I/O data is mapped by RSNetWorx.

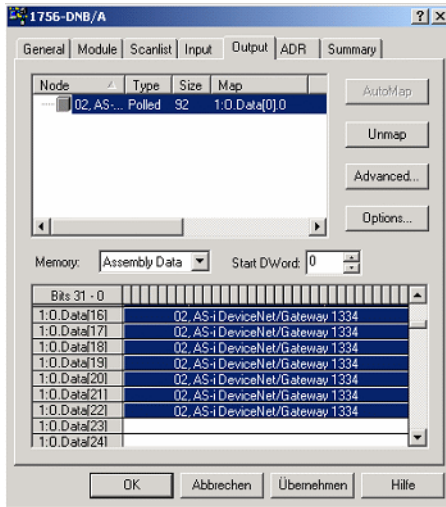

(See chapter 15.2.2.3 of this documentation.)

In our case the data is mapped in the controller tags of RS Logix 5000:

Local:1:I.Data[0] ... Local:1:I.Data[22]
 Local:1:O.Data[0] ... Local:1:O.Data[22]

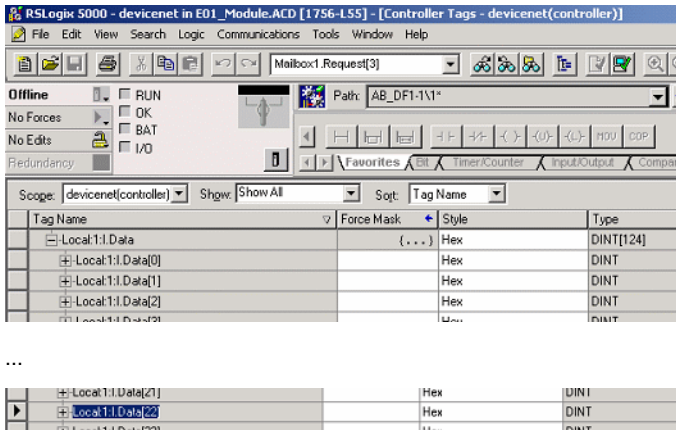

AS-Interface Appendix: integration into Rockwell PLC

Here for our example three tables, which shows you the meaning of the data.

	Digital AS-i Slaves							
	Tag	Bit No.	AS-i address	Tag	Bit No.	AS-i address		
ControlLogix ControlTags	A slaves: 1:1.Data(0)	0-3	1	A slaves: 1:1.Data(0)	0-3	1		
		4	ConfigError		4	Offline		
		5	APF		5	LOS-m-b		
		6	Pery.Fault		6	Conf.Mode		
		7	Conf.Active		7	Prot.Mode		
		B slaves: 1:1.Data(4)	8-11		3	B slaves: 1:1.Data(4)	8-11	3
			12-15		2		12-15	2
			16-19		5		16-19	5
			20-23		4		20-23	4
	24-27		7	24-27	7			
	28-31		6	28-31	6			
	A slaves: 1:1.Data(1)		0-3	9	A slaves: 1:1.Data(1)		0-3	9
			4-7	8			4-7	8
		8-11	11	8-11		11		
		12-15	10	12-15		10		
		B slaves: 1:1.Data(5)	16-19	13		B slaves: 1:1.Data(5)	16-19	13
			20-23	12			20-23	12
			24-27	15			24-27	15
	28-31	14	28-31	14				
	A slaves: 1:1.Data(2)	0-3	17	A slaves: 1:1.Data(2)	0-3	17		
		4-7	16		4-7	16		
		8-11	19		8-11	19		
		12-15	18		12-15	18		
		B slaves: 1:1.Data(6)	16-19		21	B slaves: 1:1.Data(6)	16-19	21
			20-23		20		20-23	20
			24-27		23		24-27	23
	28-31	22	28-31	22				
	A slaves: 1:1.Data(3)	0-3	25	A slaves: 1:1.Data(3)	0-3	25		
		4-7	24		4-7	24		
		8-11	27		8-11	27		
		12-15	26		12-15	26		
		B slaves: 1:1.Data(7)	16-19		29	B slaves: 1:1.Data(7)	16-19	29
20-23			28		20-23		28	
24-27			31		24-27		31	
28-31		30	28-31		30			

Issue date - 20.4.2007

AS-i DeviceNet Gateway

Appendix: integration into Rockwell PLC

		16-Bit AS-i Slaves					
		Tag	Bit No.	AS-i address	Tag	Bit No.	AS-i address
ControlLogix ControlTags	1:I.Data(8)	0-7	31 ch1 LB	1:O.Data(8)	0-7	31 ch1 LB	
		8-15	31 ch1 HB		8-15	31 ch1 HB	
		16-23	31 ch2 LB		16-23	31 ch2 LB	
		24-31	31 ch2 HB		24-31	31 ch2 HB	
	1:I.Data(9)	0-7	31 ch3 LB	1:O.Data(9)	0-7	31 ch3 LB	
		8-15	31 ch3 HB		8-15	31 ch3 HB	
		16-23	31 ch4 LB		16-23	31 ch4 LB	
		24-31	31 ch4 HB		24-31	31 ch4 HB	
	1:I.Data(10)	0-7	30 ch1 LB	1:O.Data(10)	0-7	30 ch1 LB	
		8-15	30 ch1 HB		8-15	30 ch1 HB	
		16-23	30 ch2 LB		16-23	30 ch2 LB	
		24-31	30 ch2 HB		24-31	30 ch2 HB	
	1:I.Data(11)	0-7	30 ch3 LB	1:O.Data(11)	0-7	30 ch3 LB	
		8-15	30 ch3 HB		8-15	30 ch3 HB	
		16-23	30 ch4 LB		16-23	30 ch4 LB	
		24-31	30 ch4 HB		24-31	30 ch4 HB	
	1:I.Data(12)	0-7	29 ch1 LB	1:O.Data(12)	0-7	29 ch1 LB	
		8-15	29 ch1 HB		8-15	29 ch1 HB	
		16-23	29 ch2 LB		16-23	29 ch2 LB	
		24-31	29 ch2 HB		24-31	29 ch2 HB	
	1:I.Data(13)	0-7	29 ch3 LB	1:O.Data(13)	0-7	29 ch3 LB	
		8-15	29 ch3 HB		8-15	29 ch3 HB	
		16-23	29 ch4 LB		16-23	29 ch4 LB	
		24-31	29 ch4 HB		24-31	29 ch4 HB	

LB = low byte; HB = high byte

AS-Interface Appendix: integration into Rockwell PLC

		Mailbox					
		Tag	Bit No.	Response	Tag	Bit No.	Request
Control Logix Controller Tags	1:I.Data(14)	0-7	command	1:O.Data(14)	0-7	command	
		8-14	circuit		8-13	circuit	
		15	toggle bit		14	-	
		16-23	resp.byte1		15	toggle bit	
		24-31	resp.byte2		16-23	req.byte1	
	1:I.Data(15)	0-7	resp.byte3	1:O.Data(15)	0-7	req.byte3	
		8-15	resp.byte4		8-15	req.byte4	
		16-23	resp.byte5		16-23	req.byte5	
		24-31	resp.byte6		24-31	req.byte6	
	1:I.Data(16)	0-7	resp.byte7	1:O.Data(16)	0-7	req.byte7	
		8-15	resp.byte8		8-15	req.byte8	
		16-23	resp.byte9		16-23	req.byte9	
		24-31	resp.byte10		24-31	req.byte10	
	1:I.Data(17)	0-7	resp.byte11	1:O.Data(17)	0-7	req.byte11	
		8-15	resp.byte12		8-15	req.byte12	
		16-23	resp.byte13		16-23	req.byte13	
		24-31	resp.byte14		24-31	req.byte14	
	1:I.Data(18)	0-7	resp.byte15	1:O.Data(18)	0-7	req.byte15	
		8-15	resp.byte16		8-15	req.byte16	
		16-23	resp.byte17		16-23	req.byte17	
		24-31	resp.byte18		24-31	req.byte18	
	1:I.Data(19)	0-7	resp.byte19	1:O.Data(19)	0-7	req.byte19	
		8-15	resp.byte20		8-15	req.byte20	
		16-23	resp.byte21		16-23	req.byte21	
		24-31	resp.byte22		24-31	req.byte22	
	1:I.Data(20)	0-7	resp.byte23	1:O.Data(20)	0-7	req.byte23	
		8-15	resp.byte24		8-15	req.byte24	
		16-23	resp.byte25		16-23	req.byte25	
		24-31	resp.byte26		24-31	req.byte26	
	1:I.Data(21)	0-7	resp.byte27	1:O.Data(21)	0-7	req.byte27	
		8-15	resp.byte28		8-15	req.byte28	
		16-23	resp.byte29		16-23	req.byte29	
		24-31	resp.byte30		24-31	req.byte30	
	1:I.Data(22)	0-7	resp.byte31	1:O.Data(22)	0-7	req.byte31	
8-15		resp.byte32	8-15		req.byte32		
16-23		resp.byte33	16-23		req.byte33		
24-31		resp.byte34	24-31		req.byte34		

Issue date - 20.4.2007

16 Appendix: integration into Rockwell PLC PLC5

This chapter shows exemplarily the integration of an AS-i/DeviceNet gateway into a Rockwell PLC PLC5.

The example exists out of a Rockwell PLC PLC5, a SDN 1771 card as DeviceNet scanner and an AS-i 3.0 DeviceNet Gateway with connected AS-i circuit as well as the software package „RSNetWorx for DeviceNet“.

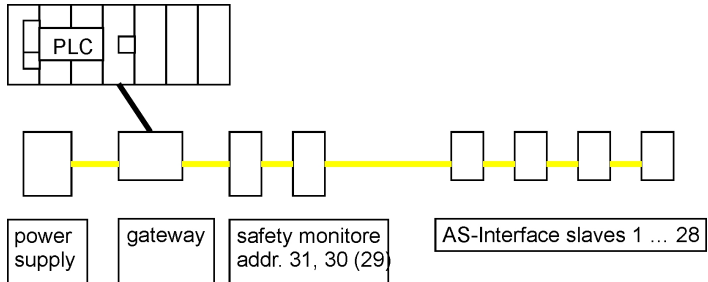

Configuration example (scheme)

For integration of the gateway into a Rockwell PLC PLC5 it is necessary first to configure the AS-i 3.0 DeviceNet gateway (adjusting the node address and the DeviceNet baudrate). After this configuration the gateway can be integrated into the PLC.

16.1 Configuration of the AS-i 3.0 DeviceNet Gateway

16.1.1 Adjusting the Node Address in the DeviceNet Circuit

1. Connect the gateway to power supply (24 V DC).
2. connect the AS-i network cable(s) to the gateway, switch on AS-i power supply.
3. Call the configuration "mode/diagnostics" menu at the gateway by pressing the "OK"-button.
4. Highlight the line "DeviceNet" by pressing "mode/↑" and select with the "OK" button. Now select "MAC ID" and confirm with the "OK" button.
5. At the display is now to be seen: "MAC ID", "OLD ID" and "NEW ID", showing the actual node address in the DeviceNet network.
6. Change to line "NEW ID" by pressing the button "set/↓".
7. Go to edit mode by pressing "OK".
8. Now the flashing tenfold number of the node address can be changed by pressing the buttons "mode/↑" and "set/↓". After confirming by the "OK" button you can adjust the flashing lower number of the address.
9. Once the node address is correctly, save it as the actual by pressing the "OK"-button.
10. Leave the menu by pressing "ESC".

Now the DeviceNet address is adjusted and stored in the gateway.

16.1.2 Adjusting the DeviceNet Baudrate

1. Go to menu "DeviceNet".
2. Go to mark "DN BAUDRATE" by pressing "set/↓", confirm with "OK".
3. Now the display shows the actual DeviceNet baudrate (i. e. 125, 250 or 500).
4. Change to the line "NEW RATE" by pressing "set/↓" and go to edit mode by pressing "OK".
5. Select the wanted baudrate by "↑↓" and acknowledge with "OK".
6. Leave the menu "configuration/diagnostics" by three times pressing "ESC".

Now the gateway changes the operation mode to run mode.

16.2 Communication of the Gateway to the PLC

The data exchange with the PLC mostly is done in polling mode. Here are transmitted even 16 bytes of input and 16 bytes of output data.

The gateway has to be configured in the DeviceNet scanner. If using a PLC 5 controller, this means a SDN 1771 DeviceNet scanner module. For getting the communication between the controller and the DeviceNet scanner established, you have to program blocktransfer operations in the controllers logic.

By the length of the blocktransfers they are defined as DeviceNet I/O polling messages.

The scanner interpretes blocktransfers with a length of 62, 61, ... 57 words as "I/O message polling" transfers automatically. A 64 word long transfer, however, is used for "explicit messaging I/O" functionality, which is usually not needed:

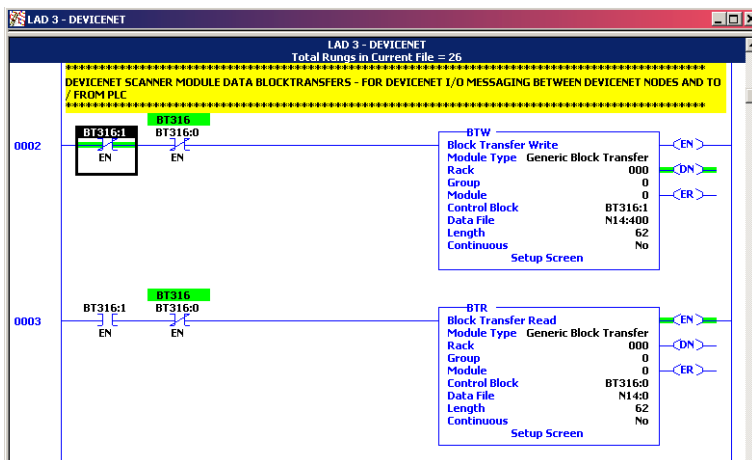

Blocktransfers write/read in the PLC program

Issue date - 20.04.2007

In the example a 62 word blocktransfer is used to transfer AS-i data via the gateway to the controller and vice versa. The configuration of the data transfer has to be done in the RSNetwork for DeviceNet software as follows:

- Import the EDS file of the gateway in "RSNetwork for DeviceNet"
- Implement the SDN 1771 and the gateway into the *.dnt file
- Open the scanlist of the SDN 1771 scanner module and add the gateway to the scanlist
- Verify the I/O mapping of the gateway in the SDN 1771 module:
 - Confirm the gateway as polled I/O with 16 bytes RX and 16 bytes TX
 - Select the datatable in the 62 word blocktransfer (example: starting at word 0)

In the example the datatable for the 62 word blocktransfer is set as follows:

BTR to N14:0	Inputs (data from AS-i)
BTW to N14:400	Outputs (data from AS-i)

The data table for both blocktransfers begins at the address 0. This word 0 generally is used for internal purposes, and so the AS-i data are to be found starting at word 1. The gateway uses in each case 16 bytes for read and write data, which are structured as follows:

AS-Interface

Appendix: integration into Rockwell PLC PLC5

	Read (Inputs from AS-i Slaves)			Write (Outputs to AS-i Slaves)		
	Word	Bit No.	AS-i Address	Word	Bit No.	AS-i Address
PLC data table	N14:1	0-3	1	N14:401	0-3	1
		4	ConfigError		4	Offline
		5	APF		5	LOS-m-b
		6	Pery.Fault		6	Conf.Mode
		7	Conf.Active		7	Prot.Mode
		8 - 11	3		8 - 11	3
		12 - 15	2	12 - 15	2	
	N14:2	0 - 3	5	N14:402	0 - 3	5
		4 - 7	4		4 - 7	4
		8 - 11	7		8 - 11	7
		12 - 15	6		12 - 15	6
	N14:3	0 - 3	9	N14:403	0 - 3	9
		4 - 7	8		4 - 7	8
		8 - 11	11		8 - 11	11
		12 - 15	10		12 - 15	10
	N14:4	0 - 3	13	N14:404	0 - 3	13
		4 - 7	12		4 - 7	12
		8 - 11	15		8 - 11	15
		12 - 15	14		12 - 15	14
	N14:5	0 - 3	17	N14:405	0 - 3	17
		4 - 7	16		4 - 7	16
		8 - 11	19		8 - 11	19
		12 - 15	18		12 - 15	18
	N14:6	0 - 3	21	N14:406	0 - 3	21
		4 - 7	20		4 - 7	20
		8 - 11	23		8 - 11	23
		12 - 15	22		12 - 15	22
	N14:7	0 - 3	25	N14:407	0 - 3	25
		4 - 7	24		4 - 7	24
		8 - 11	27		8 - 11	27
12 - 15		26	12 - 15		26	
N14:8	0 - 3	29	N14:408	0 - 3	29	
	4 - 7	28		4 - 7	28	
	8 - 11	31		8 - 11	31	
	12 - 15	30		12 - 15	30	

16.3 Configuring the AS-i Gateway in the DeviceNet Scanner

Import the EDS file of the AS-i gateway in "RSNetWorx for DeviceNet". In the menu "Hardware" choose "Bihl & Wiedeman - Communication Adapter" and add the device to the DeviceNet structure.

The gateway now can be addressed and configured: right click or double-click on it to open the menu "Properties".

Issue date - 20.04.2007

and at least the interface addresses for input and output data blocktransfers are determined. In generally they are predefined to start at N9:0.

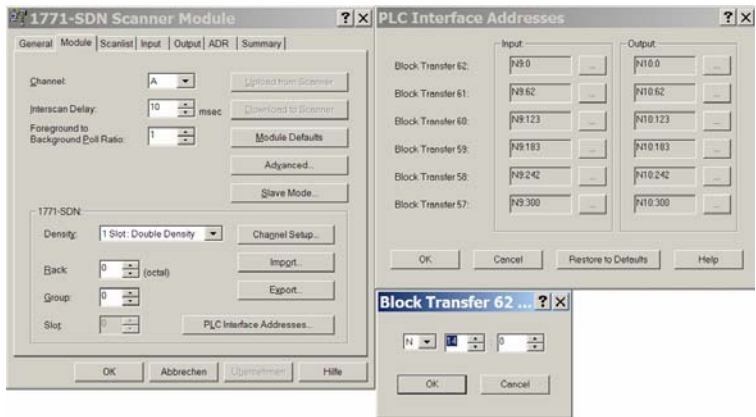

Configure data exchange presets and interface addresses

Appendix: integration into Rockwell PLC PLC5

In the folder "Scanlist" the gateway is now selected in the available devices table and added by clicking ">" and "apply" into the module's scanlist. The field "Automap on Add" should be activated at this time:

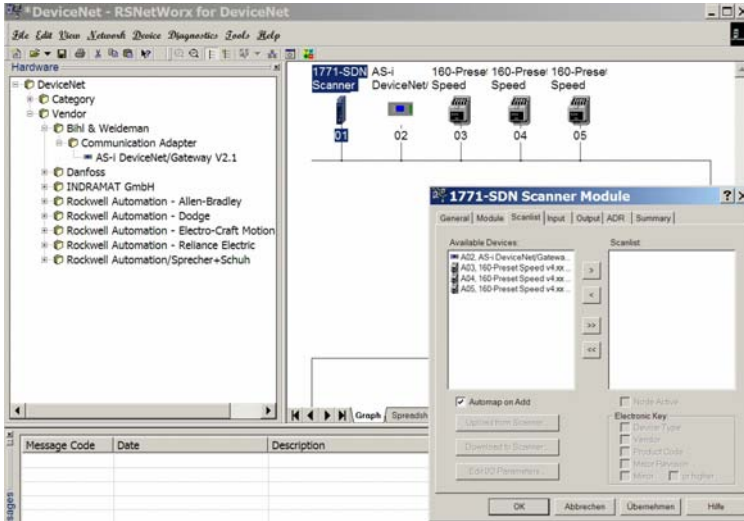

Insert gateway into the scanlist of the DeviceNet module

AS-i DeviceNet Gateway

Appendix: integration into Rockwell PLC PLC5

The folder "Edit I/O Parameters" allows defining the method of data exchange: polled, change of state or strobed. Usually "polled" is chosen, and change of state is deactivated:

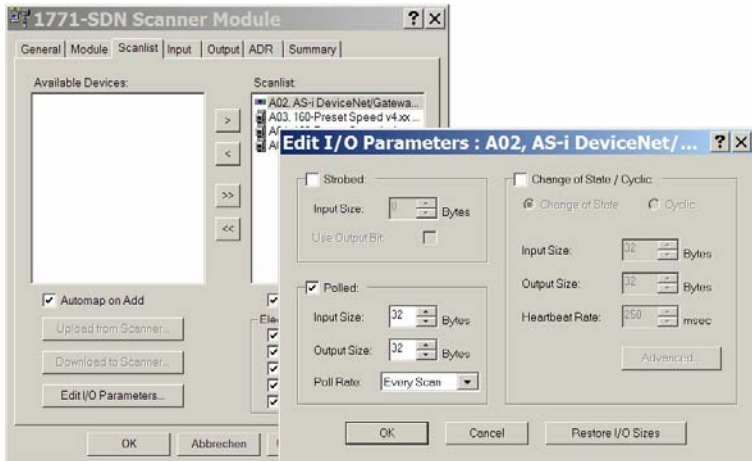

Defining data exchange

The address range for input and output data were automatically reserved by adding the gateway to the scanner module's scanlist with activated "Automap" function. The range is to be found in the folders "Input" respective "Output". If needed, they can be adjusted:



Folder "Input"

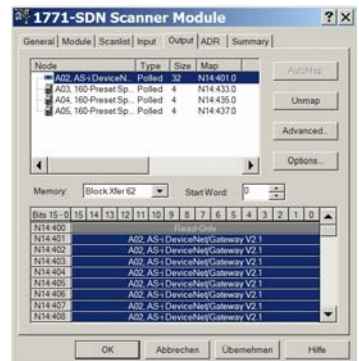

Folder "Output"

Finally, save the DeviceNet structure in RSNetwork for DeviceNet and download it to the network.

17 Glossary: AS-i Terms

A/B slave

AS-i slave with extensible addressing: The address range of an A/B slave runs from 1A to 31A and from 1B to 31B. As the master needs the fourth output data bit for switching between A and B address, A/B slaves only have three output data bits maximum.

Activation phase

In the activation phase the detected slaves are activated by sending the parameter. This is indicated by a "42" on the Master's Display. This phase takes only 10 ms, tops, to short to be displayed.

AS-i power fail

Voltage drop on the AS-i line; by falling below an assigned value the master changes to the ⇒ *Off-line phase*.

Inclusion phase

After the data exchange with all AS-i slaves the master is searching for new slaves. For this purpose an detection telegram is sent to one AS-i address and in case of an answer the master tries to read the ⇒ *actual configuration* of the slave. Depending on the mode (⇒ *protected mode* or ⇒ *configuration mode*) and on the actual configuration the detected slave will be activated.

After each data exchange with all AS-i slaves only one detection telegram is sent to one slave address. So the AS-i cycle is always one telegram longer as expected from the number of activated slaves (⇒ LAS).

Autoprogram flags

Auto Address Enable; flag from the Host to the AS-i Master

With this flag, automatic addressing can be enabled or inhibited.

This flag is stored non-volatile in the Master.

Auto Address Assign, Auto Address Possible; flag from the AS-i Master to the Host

The automatic programming is not inhibited and there is no configuration error.

A failing slave could be addressed automatically.

Auto Address Available, flag from the AS-i Master to the Host

Exactly one AS-i slave is missing and the automatic programming is not inhibited.

If a slave with the address 0 and the profile of the missing slave is connected, it receives the address of the missing slave automatically.

IO-Code

The first digit of the slave profile indicates the number of inputs and outputs of the slave. A 4I/4O slave e.g. is associated to "7", a slave with 4 digital Inputs to "0".

Detection phase

In the detection phase at start-up the master is scanning for AS-i slaves. It remains in this phase until at least one slave is detected. If the master remains in the detection phase this means that no slave was found. The reason for this may be a wrong power supply or a wiring error.

The detection phase is displayed by code "41".

Protected mode

In protected mode only those slaves are activated which are registered in the ⇒ *LPS* and whose actual configuration matches with the target configuration.

See ⇒ *configuration mode*. This mode is intended for the normal operation, since all AS-i protective measures are activated.

ID code

The ID code is unchangeably set by the manufacturer of the AS-i slave. The AS-i Association defines the ID codes assigned to a certain category of slaves. All ⇒ *A/B slaves* e.g. possess the ID code "A".

ID1 code, extended ID1 code

The ID1 code is specified by the manufacturer of the slave. In contrast to the other codes defining the profile this code can be modified by the master or by an addressing unit. The user should make use of this possibility only in exceptional cases, otherwise ⇒ *configuration errors* may occur.

To make the distinction between the A and the B addresses in the case of A/B slaves, the bit with the highest value of the ID1 code is used. That is why only the three lowest bits are relevant for these slaves. Since this code has been introduced with the new AS-i specification 2.1, it is also called extended ID1 code.

ID2 code, extended ID2 code

The ID2 code is unchangeably set by the manufacturer of the slave. The AS-i Association defines the ID2 codes assigned to a certain category of slaves. All two-channel 16-bit input slaves with the profile S-7.3 possess the ID2 code "D". Since this code has been introduced with the new AS-i specification 2.1, it is also called extended ID2 code.

Actual configuration

The configuration data of all slaves detected by the master. The configuration data of one slave, the ⇒ *slave profile*, consists of:

⇒ *IO code*, ⇒ *ID code*, ⇒ *extended ID1code 1*, ⇒ *extended ID2 code*.

Actual parameter

The AS-i parameter that have been sent last to the AS-i slave, in contrary to ⇒ *permanent parameters*.

Configuration Error/Config Error

An configuration error is indicated, when target and actual configuration of the connected slaves do not match. The following cases may result in configuration errors:

Missing slave:A slave entered in the \Rightarrow *LPS* is not available

Erroneous type of slave:The \Rightarrow *slave profile* of the connected slave does not comply with the configured one.

Unknown slave:A connected slave is not entered in the \Rightarrow *LPS*.

LAS - List of Activated Slaves

The master exchanges IO data with the slaves entered in the LAS. In the protected mode only those detected slaves (\Rightarrow *LDS*) are activated which are expected by the master and are entered in the \Rightarrow *LPS*. In the configuration mode all slaves entered in the \Rightarrow *LDS* are activated.

LDS - List of Detected Slaves

All slaves from which the master was able to read the \Rightarrow *slave profile* are entered in the LDS.

LPF - List of Peripheral Faults

There is a list of peripheral faults only for masters fulfilling the new specification 2.1. This list includes an entry for each slave that signals a \Rightarrow *peripheral fault*.

LPS - List of Projected Slaves

The list of projected slaves includes all slaves expected by the master. All entries of the \Rightarrow *LDS* are taken over to the LPS by storing the actual configuration (except for a not addressed slave with the address 0).

Offline phase

In the offline phase all input and output data is reset. This phase is entered at start-up of the master, after a \Rightarrow *AS-i power fail*, and at the transition of the \Rightarrow *configuration mode* to the \Rightarrow *protected mode*.

Furthermore the master can actively be put into the offline phase with the offline flag.

During the offline phase, masters with a display show code "40".

Peripheral fault

A peripheral fault is shown on the master and on the slave by a red flashing LED. Depending on the slave type it is possible to visualize an overflow, an overload of the sensor's power supply or another fault regarding the peripheral equipment of the slave.

Permanent configuration

The configuration data of all expected slaves stored in the master (\Rightarrow *slave profile*). If the permanent configuration differs from the \Rightarrow *actual configuration*, there is a configuration error.

Permanent parameter

The parameter stored in the master that are sent to the slave after start-up of the master in the \Rightarrow *activation phase*.

Configuration mode

During the configuration mode the master exchanges data with all connected slaves, no matter which of the slaves are projected. In this mode it is possible to commission a system without being obliged to configure it before.

See also \Rightarrow *protected mode*.

Single slave

Compared to an \Rightarrow *A/B slave* a single slave can only be addressed from the address 1 to 31; the fourth data output bit can be used. All slaves of the older specification 2.0 are single slaves.

There are also slaves fulfilling the new specification 2.1 that are single slaves, e.g. the newer 16-bit slaves.

Slave profile

The configuration data of a slave consisting of:

\Rightarrow *IO code*, \Rightarrow *ID code*, \Rightarrow *extended ID1 code*, \Rightarrow *extended ID2 code*.

The slave profile is to differentiate between the different slave categories. It is specified by the AS-i Association and preset by the slave manufacturer.

AS-i 2.0 slaves do not have extended ID1 and ID2 codes. In this case an AS-i master 2.1 enters "F" the extended ID1 and the extended ID2 code.

FACTORY AUTOMATION – SENSING YOUR NEEDS



Worldwide Headquarters

Pepperl+Fuchs GmbH
68307 Mannheim · Germany
Tel. +49 621 776-0
E-mail: info@de.pepperl-fuchs.com

USA Headquarters

Pepperl+Fuchs Inc.
Twinsburg, Ohio 44087 · USA
Tel. +1 330 4253555
E-mail: sales@us.pepperl-fuchs.com

Asia Pacific Headquarters

Pepperl+Fuchs Pte Ltd.
Company Registration No. 199003130E
Singapore 139942
Tel. +65 67799091
E-mail: sales@sg.pepperl-fuchs.com

www.pepperl-fuchs.com

 **PEPPERL+FUCHS**
SENSING YOUR NEEDS

Subject to modifications
Copyright PEPPERL+FUCHS • Printed in Germany

TDOCT1111B_ENG / 195392
08/2009