

Startup

SK-PROFIBUS SPI3 Profibus-DP Interface

Contents

1	Important information.....	2
1.1	General information.....	2
1.2	Safety instructions.....	3
1.3	Symbols used in this manual	4
2	Scope of supply – software	5
2.1	Device master file for the SPI3 module: thdp0091.gsd.....	5
2.2	TERMEX ^{PRO} demo projects for EXTEC terminals	5
2.3	Demo projects for the S7-300/400 series	5
2.4	STEP5 demo project.....	6
3	S7 PROFIBUS-DP interface.....	7
3.1	General.....	7
3.2	Prerequisites	7
3.3	Cable connections.....	7
3.4	Configuration.....	8
3.4.1	Configuring TERMEX 2xx/3xx/7xx.....	8
3.4.2	DP slave address for SPI3.....	8
3.4.3	Siemens S7 via Profibus-DP	9
3.4.4	S7 programming	11
3.4.5	Connection of several SPI3 DP slaves	16
3.5	Testing the demo projects.....	16
3.5.1	Loading a demo project in the S7	16
3.5.2	Loading a demo project onto the terminal	17
3.5.3	Visualizing the data exchange	18
3.5.4	Optimum response times.....	19
3.6	Problems with the S7-Profibus-DP interface	21
4	Problems with the S7 interface.....	22
4.1	PROFIBUS connection between the PLC and the SPI3.....	22
4.2	Serial connection between the SPI3 and the terminal.....	22
4.3	Including and accessing the SPI3 module	23
5	S5-PROFIBUS interface.....	25
6	Appendix	26
6.1	Communication settings.....	26
6.1.1	TERMEX 2xx/3xx	26
6.1.2	TERMEX 7xx	28
6.2	Connecting cables.....	30
6.2.1	TERMEX 2xx/3xx	30
6.2.2	TERMEX 750	31
6.3	Block diagrams.....	32
6.3.1	TERMEX 2xx/3xx connected to ENT-DC	32
6.3.2	TERMEX 750 connected to SK-LWL.....	32
6.4	Communication with 2 SPI3 DP slaves.....	33

1 Important information

1.1 General information

Copyright © 2004 by Pepperl+Fuchs - EXTEC GmbH
All rights reserved.

The publisher reserves the right to alter the information and data contained in this manual without prior notice. Unless otherwise indicated, the company names as well as other names and data used in the examples are purely fictitious.

The publisher may have registered patents or pending patent applications for subject matter covered in the manual. This manual does not give you license to these patents.

Limited warranty:

No warranty is provided for the accuracy of the information contained in this manual. As mistakes cannot be entirely avoided despite taking the greatest of care, we would be grateful to receive information about any errors you may discover. The publisher disclaims all legal responsibility or liability for errors as well as for subsequent damages and claims.

Microsoft, MS, MS-DOS, Windows 2000, Windows XP Professional; Windows XP embedded are registered trademarks of the Microsoft Corporation.

How to contact Pepperl+Fuchs - EXTEC GmbH:

Should you encounter any problems with the SK-Profibus SPI family, please consult this "Technical Manual" first of all. If you are still unable to solve the problems after studying the above information carefully, you can contact Pepperl+Fuchs - EXTEC GmbH directly as follows:

- 1) Internet: <http://www.extec.de>
- 2) E-mail: support@extec.de
- 3) Support hotline: Tel. +49 (0)711/31 54 55 12
- 4) Write to the address below

If you need to contact the EXTEC support hotline, please make sure you have this "Technical Manual" handy!



Latest information, new products, support, updates, etc.

You can call up the latest information about EXTEC products on the Support page of our web site (Internet address: <http://www.extec.de>)

or ask to be put on the mailing list for the **EXTEC NEWSLETTER**, our regular circular which will then be sent to you automatically. Please consult the EXTEC web site for details of how to subscribe.

Publisher:

Pepperl+Fuchs - EXTEC GmbH
Schorndorfer Straße 55
D-73730 Esslingen

1.2 Safety instructions

- ⇒ These devices are only allowed to be installed and operated by trained and qualified personnel who have received suitable instruction in their use.
- ⇒ These devices represent state-of-art technology. They are only allowed to be connected to systems that have been approved by EXTEC Oesterle GmbH.
- ⇒ Never open the devices yourself. They are only allowed to be opened by authorized Pepperl+Fuchs - EXTEC GmbH personnel.
Pepperl+Fuchs - EXTEC GmbH is not liable for any resulting damages.
- ⇒ The devices are not allowed to be modified or otherwise altered in any way.
Pepperl+Fuchs - EXTEC GmbH is not liable for any resulting damages.
- ⇒ Please study the "**Technical Manual**" carefully prior to starting up the devices.
- ⇒ The most recent version of the "**Technical Manual**" is always valid. It is available for downloading on our web site: <http://www.extec.de>.
- ⇒ The operating voltage of the devices **must not exceed the limits** indicated in the **technical data** section of the "**Technical Manual**". In the event of failure to comply, **Pepperl+Fuchs - EXTEC GmbH is not liable for any resulting damages.**
- ⇒ The relevant **specifications for hazardous areas** (VDE 0160, VDE 0165, EN 50014 - 50039) and **accident prevention regulations (UVV)** must be observed.

The technical data specified for the hazardous area corresponds to the certified values for the European EEx approval. The user is responsible for ensuring that the devices are suitable for their intended application and for the prevailing ambient conditions.

No warranty can be given by Pepperl+Fuchs - EXTEC GmbH in this connection.

Data subject to change without notice

1.3 Symbols used in this manual



Warning: -> The specified technical data must be complied with. Failure to do so may result in dangerous situations or damage.

Caution: -> Careful installation is necessary: Do not replace electrical fuses with fuses from other manufacturers. Failure to comply may result in dangerous situations or damage.

Important: -> The product may be impaired or damaged as a result of external influences.



Safe area: -> Assembly and installation are only permitted in the **safe area**. All power cables used in the hazardous area (**Zone 1** and **Zone 2**) must be of the **DATL-A** type.

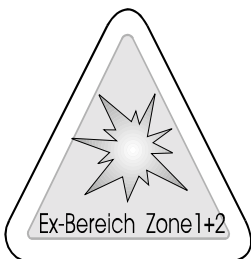

Important: Hazardous area (Zones 1+2) -> All safety requirements, the **test certificates for hazardous areas** and the **Ex** and **VDE** specifications relating to operation of the devices in the **hazardous area (Zones 1 and 2)** must be complied with.

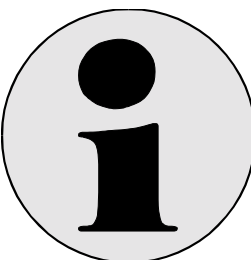

Additional information: -> Information and instructions that should be observed **additionally**.



Pressure load: -> Severe mechanical **pressure** or **shock loads** may damage the devices.

kein mechanischer Druck

2 Scope of supply – software

The following files and projects are included in the scope of supply of the software for the SPI3 module:

2.1 Device master file for the SPI3 module: thdp0091.gsd

The device master file **thdp0091.gsd** in the *EXTEC\SK_PROFIBUS_SPI3\STEP7\GSD* folder contains configuration data for the SPI3 serial port. It must be copied to the *Siemens\Step7\S7data\Gsd* folder in order to tell STEP 7, the Siemens Simatic software, that a new external field device (in this case the SPI3 module) is to be added to the hardware catalog.

File name	Size	Changed	Version	HW Rel.	SW Rel.
thdp0091.gsd	49,493 bytes	06.05.2002	2.2	1.0	1.3

2.2 TERMEX^{PRO} demo projects for EXTEC terminals

The *EXTEC\SK_PROFIBUS_SPI3\Examples* folder contains appropriate TERMEX^{PRO} demo projects designed to familiarize you with the functions and operation of the SPI in combination with an S7 PLC and an EXTEC terminal.

The subdirectories in this folder contain the TERMEX^{PRO} demo projects for the various EXTEC terminals, as shown in the table below:

Demo project	Suitable for terminals	Terminal type
T220cpy	TERMEX 220, 320 (former models: TERMEX 200, 300)	Text terminal
T230cpy	TERMEX 230, 330 (former models: TERMEX 210, 310)	Graphic terminal
T770cpy	TERMEX 770 (former model: TERMEX 750)	color-graphic terminal

The demo projects allow you to enter data on the terminal in DW78 (SET variable). This value is transferred from the terminal via the SPI3 to an S7 PLC using the 3964R/RK512 protocol. Data words DW84..., DW198, which are output on the terminal, contain the values of the corresponding data block that has been created in the PLC (ACTUAL variables).

In conjunction with the demo projects described below for the S7-300 (and S7-400) series, these projects can be used to visualize communication between the terminal, the SPI3 and the PLC. In particular, they enable the probable response times to be estimated.

2.3 Demo projects for the S7-300/400 series

All four S7 demo projects were created with SIMATIC Manager V 5.1 SP3. Since the projects are basically identical, we shall only provide a brief description of the differences in the following:

Project	Folder	CPU	RK512 interpretation	Remarks
Ex315FB103	Ex315D1	315-2AF02-0AB0	OB 1	SPI3 demo
Ex315FB103_2	Ex315D2	315-2AF02-0AB0	OB 35	2x SPI3 demo
Ex413FB103	Ex413D1	413-2XG01-0AB0	OB 1	SPI3 demo
Ex315FB103OB35	Ex315R1	315-2AF02-0AB0	OB 35	Starting point for user applications

The S7 demo projects are located in the *EXTEC\SK_PROFIBUS_SPI3\STEP7\Examples* folder. Please use the GSD file described in section 2.1.

The SPI3 DP-Slave Modul_C1CF01 is responsible for reading and writing 32 bytes in the configured slave I/O area. The OBs, FBs and DBs are basically identical for all projects. You can of course also copy them to user projects:

1. **Ex315FB103OB35:** Minimum project to demonstrate a typical configuration of an S7-315-2DP. It provides an ideal starting point for customizing. Communication with the TERMEX takes place in OB 35.
2. **Ex315FB103:** S7 demo project for the S7-315-2DP. In conjunction with the TERMEX^{PRO} demo projects (refer to section 2.2) it visualizes the data exchange between the PLC and the terminal. Communication takes place in OB 1. FC 1, which copies the contents of DB2.DW78 to data words DB2.DW84, DB2.DW90, ... DB2.DW198, is called at the end of OB 1, however.
3. **Ex315FB103_2:** S7 demo project for the S7-315-2DP with 2x SPI3 DP slaves for 2x TERMEX on an S7 PLC. In conjunction with the TERMEX^{PRO} demo projects (refer to section 2.2), it shows how terminals can be connected via two SPI3 modules. Communication can take place alternatively in OB 35. FC 1, which copies the contents of DB2.DW78 to data words DB2.DW84, DB2.DW90, ... DB2.DW198, is called in OB 1.
4. **Ex413FB103:** Similar to Ex315FB103 but for the S7-413-2DP.

The Ex315FB103, Ex315FB103_2 and Ex413FB103 demo projects can be used to calculate the response times for a particular installation or configuration (terminal <-> S7 PLC).

Note: In order to visualize data communications, you should load one of the S7 demo projects (Ex315FB103 or Ex413FB103) on the S7 side and one of the projects described in section 2.2 on the terminal side (refer to section 3.5).

2.4 STEP5 demo project

The *EXTEC\SK_PROFIBUS_SPI3\STEP5* folder contains files for connecting the SPI3 module via STEP 5. Please refer to section 5.

3 S7 PROFIBUS-DP interface

This section contains a detailed description of the configuration of the Siemens S7 PLC and the TERMEX 2xx/3xx/7xx when connected to the Profibus-DP interface via the SPI3 module.

3.1 General

The TERMEX 2xx/3xx/750 is the communication master. It uses the 3964R protocol to communicate with the SPI-3, which forwards requests to the S7 via the PROFIBUS.

These requests are processed by the S7 in a cyclically called function block FB 103 and answered over the PROFIBUS. The SPI3 converts the data packets back to the 3964R protocol for the TERMEX 2xx/3xx/7xx.

Note: The Trebing & Himsted documentation refers to FB 200, FB 201 and FB 202. These function blocks are not required for the PROFIBUS-DP interface described here. FB 103 is used to convert the RK512 protocol instead.

T&H offers FB 106 in combination with new modules for Release 12 of the SPI3 (see housing rear). These modules are not yet supported by us!

Note on addressing:

The S7 world is *byte-oriented*, not *word-oriented* like the S5 world, in other words if data word DW78 is addressed in the terminal, byte 156 and byte 157 rather than the high and low bytes of data word DW78 are actually selected.

3.2 Prerequisites

Hardware	Software
<ul style="list-style-type: none"> • S7-CPU (i.e. CPU 315 -2DP or CPU 413-2DP for demo projects) • PROFIBUS cable with connectors • EXTEC Profibus interface SK-PROFIBUS-DP-SPI3-HS (also referred to as SPI3) • SPI 3-ENT-DC interface cable (refer to sections 6.2.1.2 and 6.2.2.2) • EXTEC mains buffer stage ENT-DC (TERMEX 2xx/3xx) or SK-LWL (TERMEX 7xx) • PC cable for mains buffer stage (refer to sections 6.2.1.1 and 6.2.2.1) • Ex-i supply cable • TERMEX 2xx/3xx/7xx terminal • PC or programmer for configuring, parameterizing and programming the S7 PLC (i.e. PC-MPI adapter) 	<ul style="list-style-type: none"> • Step7 V5.1 SP3 • EXTEC Loader for TERMEX^{PRO} demo projects (contained on the CD supplied by EXTEC or downloadable from www.extec.de) • Function block FB 103 for STEP7 (required for the 3964R/RK512 interpretation) • SPI3 device data: <code>thdp0091.gsd</code> (supplied by EXTEC)

3.3 Cable connections

You must set up a connection to a PC with the Simatic STEP 7 software in order to configure the S7 PLC or the SPI3 module. Proceed as follows to do so:

1. Connect a free serial port on your PC to the Siemens S7 PLC via the **MPI adapter**. You can then enter settings on the S7 PLC or the SPI3 module.
2. Connect the SPI3 module (on the PROFIBUS side) to the S7 PLC via the PROFIBUS by means of a standard bus connector (**PROFIBUS cable**).
3. Now connect the SPI3 module (on the RS232 side) to the ENT-DC (or the SK-LWL) using a special **SPI3 interface cable**. Please refer to section 6.2.1.2 (or 6.2.2.2) in the Appendix for the pin assignment of this cable.
4. Finally, connect the TERMEX 2xx/3xx/7xx to the ENT-DC (or the SK-LWL) using the **cables** provided for this purpose.
5. The SPI3 and the ENT-DC/SK-LWL require a 24 V DC power supply.

The following devices thus communicate with one another:

PC<->MPI adapter<->PLC<->SPI3<->ENT-DC<->TERMEX 2xx/3xx/7xx.

Fig. 1 is a schematic diagram of the cable connections. Please refer to the block diagrams in section 6.3 for the final cable connections after completing the configuration.

Notes:

- If your SPI3 is installed at the beginning or end of the PROFIBUS line, you will need terminating resistors. In this case, please always use a standard PROFIBUS connector with an integrated terminating resistor. We recommend ERNI or Siemens connectors.
- Please refer to section 6.2 for the assignment of the connecting cables.

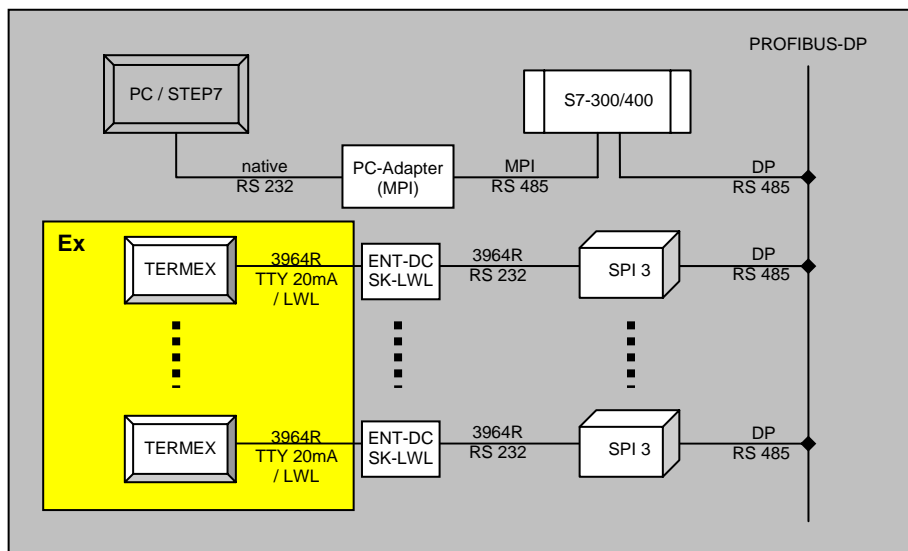

Fig. 1: Schematic diagram

3.4 Configuration

Various hardware settings are required before the Siemens PLC can communicate with the EXTEC TERME X 2xx/3xx/7xx operator and display terminal via the serial port (SPI3 module). Software adaptations may be necessary to code and data blocks.

3.4.1 Configuring TERME X 2xx/3xx/7xx

The TERME X 2xx/3xx/7xx must be set to the 3964R/RK512 protocol in the SETUP. The terminal uses this protocol to communicate with the SPI3 module in the master role (refer to sections 6.1.1 and 6.1.2), which converts the data between the PROFIBUS and the serial port.

The serial port must also be configured in the SETUP. We recommend the following settings:

- Baud rate: 19,200 baud (max. 57,600 baud for TERME X 7xx)
- Data bits: 8
- Parity: Even
- Stop bits: 1

Demo: We advise you to leave the default value for the DB set to 2 in the terminal SETUP for the purpose of our demo projects. The data exchange between the terminal and the PLC can then be directly visualized with the help of the variable table VAT 1 (STEP7 software, refer to section 3.5.3).

3.4.2 DP slave address for SPI3

The PROFIBUS-DP address (03-99) must be set while the SPI3 is deenergized with two rotary switches on the SPI3 module. We recommend the address 03 for our demo project.

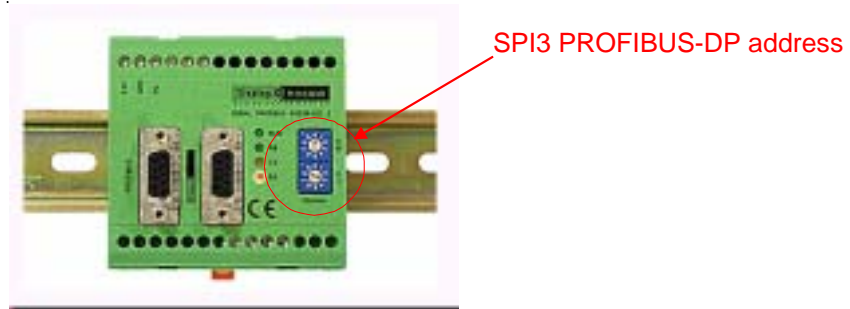

Fig. 2: Setting the DP slave address

Notes:

- PROFIBUS addresses 00 to 02 are reserved. Please only set addresses between 03 and 99.
- The SPI3 only updates the PROFIBUS address after a cold restart. Either set the PROFIBUS address when the SPI3 is deenergized or interrupt the power supply briefly after setting it.
- The RS232 side of the SPI3 module (baud rate, parity, etc.) must be configured using the STEP 7 software. The data is loaded into the SPI3 via the S7 PLC!

Demo: We recommend the PROFIBUS-DP address 03 for our demo projects.

3.4.3 Siemens S7 via Profibus-DP

The Simatic STEP 7 software is used for the hardware configuration of the S7 PLC. This configuration tells the system which modules (CPU as DP master and field device as DP slave) are used in which I/O areas as well as the PROFIBUS network settings (baud rate, parity, transmission mode, etc.) and the DP slave parameters (PROFIBUS address, baud rate).

Please proceed as follows:

1. Install the STEP 7 software.
2. Copy the device master file **thdp0091.gsd** to the *Siemens\Step7\S7data\Gsd* folder.
3. Create a new project using the STEP 7 Wizard.
4. Enter the following settings in the hardware configuration of STEP 7:
 - a. Add the PROFIBUS bar to the DP master by right-clicking the DP master and selecting *Insert DP Master System* in the context menu.
 - b. In the main menu, now select *<Options/Update GSD File>* to import the device master file (GSD) for the serial port.
 - c. The Hardware Catalog (which can be activated by selecting *<View/Catalog>* in the main menu) contains the DP slave module **SPI3** in PROFIBUS DP/Other field devices/Gateway/.

This module can now be dragged and dropped onto the PROFIBUS bar.

The DP slave address which is set here must coincide with the SPI PROFIBUS address assigned in section 3.4.2 (address 03 in the demo project)!!!

- d. Now open the SPI 3 subdirectory, select **MODUL_C1CFCF01_____** (for sending and receiving 32 bytes), drag it to the first entry in the rack and drop it there (see Fig. 3).

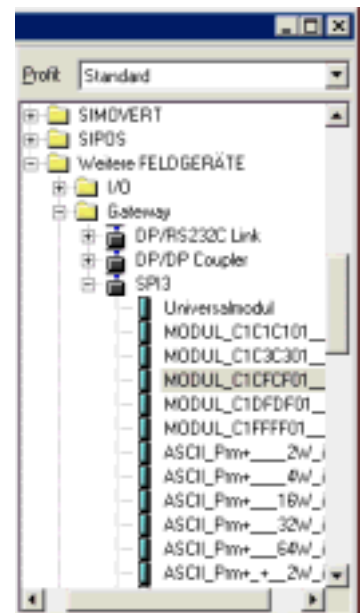

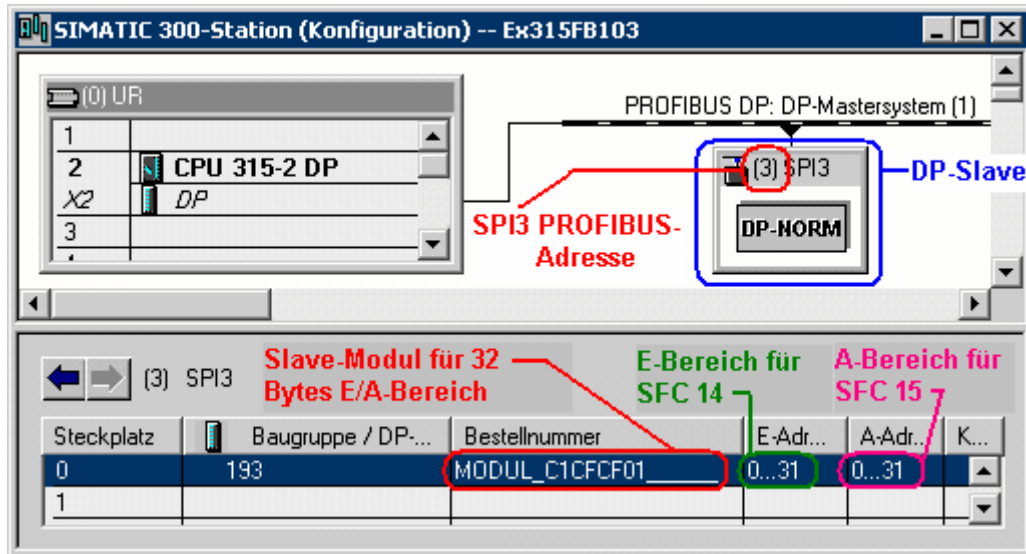

Fig. 3: Hardware configuration of the SPI3

- By double clicking on `MODUL_C1CF01`, you can set the configured **DP slave I/O addresses** of the SPI3 (see Fig. 4).
- You can also set the **serial parameters** (RS232 side) for the SPI3 by double clicking on `MODUL_C1CF01` (see Fig. 5).



Fig. 4: I/O address

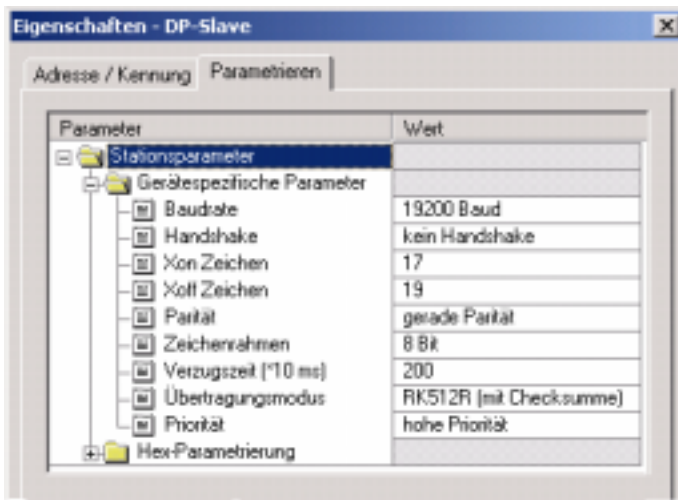

Fig. 5: Serial parameters for the SPI3

- By double clicking on the configured CPU, you can now assign the CPU's **MPI address**. If you only have one CPU, the default value for the MPI address is 2.
- The next step is to parameterize the PROFIBUS of the DP master. Double click on the DP master in the rack (top left) and enter the PROFIBUS address 2 (recommended). You can also check or display the following Profibus properties here (transmission rate: e.g. 1.5 Mbit/s).
- After the hardware has been configured, the configuration must be saved and compiled (select *Station/Save and Compile* in the menu bar). Download the hardware configuration to the CPU (select *Target System/Download to Module* in the menu bar).

The green PB LED on the SPI3 module should now remain permanently lit (see Fig. 6). If it does not, the hardware has not been configured correctly. Please refer to sections 3.6 and 4 for troubleshooting instructions.

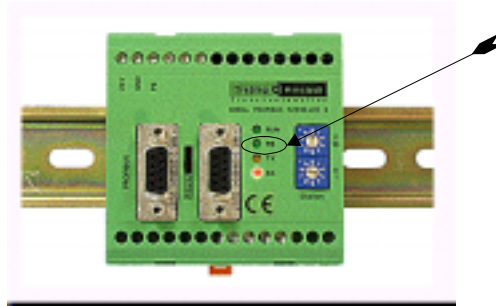

Fig. 6: Testing the PROFIBUS connection

3.4.4 S7 programming

As described above, the terminal acts as the 3964R/RK512 master and sends its requests to the PLC via the SPI3. The steps involved are described in brief below:

1. The terminal sends a 3964R/RK512 telegram to the SPI3 via the serial port.
2. The SPI3 packs the 3964R telegram in the PROFIBUS protocol and sends it to the PLC over the PROFIBUS.
3. The PLC reads the data on the PROFIBUS in order to obtain the original 3964R telegram.
4. FB 103, which works cyclically in the PLC, interprets the telegram and responds as a slave (in accordance with the 3964R/RK512 specification).
5. If (3964R) data must be returned to the terminal, it is now sent to the SPI3 over the PROFIBUS. It is forwarded from there to the serial port of the terminal.

Notes:

- From a logical viewpoint, all the SPI3 does is pack and unpack the serial data transparently in the PROFIBUS protocol.
- A suitable buffer stage (ENT-DC or SK-LWL) is of course installed between the terminal in the hazardous area and the SPI3 in the safe area. This stage has no influence on the logical sequence described above, however.

S7 programming for the SPI3 is described in detail below with the help of the **Ex315FB103OB35** demo project supplied by us in the *EXTEC\SK_PROFIBUS_SPI3\STEP7\Examples\Ex315R1* subdirectory. This project provides a very good starting point for user projects.

The following table lists the blocks that are required for the demo projects:

Block	Function	Description
OB 1	Program cycle	
OB 35	Cyclic interrupt	Calls FB 103 and SFC 14/15 cyclically
OB 80	Cycle time fault	Prevents the CPU from switching to the STOP state if a time fault occurs
OB 82	Diagnostic interrupt	Prevents the CPU from switching to the STOP state if an error is detected by a diagnostics-capable module
OB 100	Startup	Executes a RESET of the SPI3
OB 101	Restart	Executes a RESET of the SPI3 (S7-400 only)
OB 121	Programming error	Checks whether a DB exists (PLC trick)
FB 103/ DB 103	3964R/RK512 interpretation	Function block for interpreting/responding to 3964R/RK512 telegrams (as a slave)
DB 2	Data block for useful data	Data block mirrored in the terminal
DB 37	Receiving buffer for FB 103	Buffer for RK512 telegrams to be received
DB 38	Sending buffer for FB 103	Buffer for RK512 telegrams to be sent
SFC 14	Read from DP slave	Reads consistent data from the PROFIBUS
SFC 15	Write to DP slave	Writes consistent data to the PROFIBUS
VAT 1	Variable table	Used to visualize communications

The basic principle of the **Ex315FB103OB35** demo project is summarized below:

3.4.4.1 Cyclic interrupt OB 35

FB 103 is the heart of the cyclic 3964R/RK512 interpretation. It is called by OB 35 – a timer OB – at equidistant intervals. OB 35 is also responsible for reading and writing consistent data to and from the corresponding DP norm slave – the SPI3:

OB 35 : "Cyclic Interrupt"

```
EXTEC profibus demo for communicating via SPI3 with TERMEX terminals
```

Network 1: Data input

```
Read consistent data of a DP norm slave
```

```
CALL SFC 14 // "DPRD_DAT"
LADDR :=W#16#0 // DP slave input address
RET_VAL:=MW70 // Return value
RECORD :=P#M 0.0 BYTE 32 // Start input data; number of bytes
NOP 0
```

Network 2: Data processing

```
Interpret RK512 telegrams
```

```
CALL FB 103 , DB103
A_Anfang :=P#M 34.0 // See network 3: input data
E_Anfang :=P#M 0.0 // See network 1: output data
DB_Empfangen:=DB37 // Receiving buffer
DB_Senden :=DB38 // Sending buffer
S5_KOMP :=TRUE // TERMEX uses S5 addressing mode
EA_Laenge :=32 // Number of bytes to process
ANZW :=MW76
NOP 0
```

Network 3: Data output

```
Write consistent data to a DP norm slave
```

```
CALL SFC 15 // "DPWR_DAT"
LADDR :=W#16#0 // DP slave output address
RECORD :=P#M 34.0 BYTE 32 // Start output data; number of bytes
RET_VAL:=MW72 // Return value
NOP 0
```

The data transfer to and from the SPI3 over the PROFIBUS takes place in networks 1 and 3:

- In network 1, 32 data bytes are read from the SPI3 with the help of **SFC 14**, starting at the input address W#16#0, and copied into the range from M0.0 to M31.0. The return value is written in MW70.
- Network 3 copies 32 data bytes from the range between M34.0 and M65.0 to the output address starting at W#16#0 with the help of **SFC 15**. This data is then transferred to the SPI3. The return value is written in MW72.

The 3964R/RK512 telegrams are evaluated in FB 103 (together with DB 103), which is called in network 2. The telegram that is "dissected" on the PROFIBUS side is pieced together again on the RS232 side. It has the following call parameters:

Parameter	Meaning
A_Anfang	Start of the address range of the output bytes (see network 3)
E_Anfang	Start of the address range of the input bytes (see network 1)
DB_Empfangen	Data block for storing received RK512 telegrams for FB 103

DB_Senden	Data block for storing RK512 telegrams to be sent for FB 103
S5_KOMP	S5 compatibility (because addressing differs for S5 and S7) <ul style="list-style-type: none"> • 0 : Processed data word = requested data word DW2 = DW2 • 1 : Processed data word = requested data word *2 DW4 = DW2 * 2
EA_Laenge	Read/write length of the configured DP slaves (see SPI3 module)
ANZW	ANZW is a return value Bit 0: A telegram is received (out) Bit 1: A telegram is sent (out) Bit 4: Reset job (inout) – should be set in order to reset the SPI3 module

The response speed of the terminal connected via the SPI3 is determined by two main factors:

1. Data transmission rate between the SPI3 and the terminal
2. Number of interpretations of FB 103 together with calls of SFC 14/15

A maximum limit is imposed on the first of these factors by the laws of physics: the terminals operate with a maximum transmission rate of 19,200 baud (exception: TERMEX 7xx with 57,600 baud). As described later, this limits the response speed to approximately 1 second.

The load on the CPU has a crucial influence on the second factor. If not enough CPU time is available to call FB 103 (together with SFC 14/15), the 3964R telegrams are processed with a delay. The update rate of the data block is therefore slower and so is the response speed of the terminal.

The variant with the timer OB (OB 35) was developed in order to separate 3964R communication with the SPI3 from other CPU tasks as far as possible: communication with the terminal takes place at fixed times. **The cyclic interrupt of OB 35 has been set to 10 ms in the hardware configurator to optimize performance.**

Notes:

- If OB 35 is already assigned, these calls can also be accommodated in OB 1, which works cyclically.
- To avoid prevent response times, however, it is important to ensure that FB 103 is called regularly – especially with cycle times of 50 ms or more: in this case, FB 103 should be called in OB 1 several times together with SFC 14/15.
- With older SPI3 modules (< Release 12, see housing rear), there should be an interval of at least 5 ms between FB 103 calls. As far as we know, there is no lower limit of this kind for new modules (Release 12 or higher).

Our demo projects are merely intended as a guide and as a suitable starting point for user projects. Please refer to the full original documentation from Trebing & Himsted for a more in-depth description.

3.4.4.2 Communication data block DB 2

Data is exchanged between the terminal and the PLC via a communication data block. The number of the data block that is used in the terminal can be freely selected in the terminal SETUP between 2 and 255. It comprises 256 data words (or 512 bytes).

The same data block must be used on the PLC side to replicate the terminal DB.

Demo: DB 2 is used as the communication DB for our demo projects. This is also the factory setting of the terminal.

Note: The TERMEX 7xx has two consecutive communication DBs. **Both** OBs must therefore be created on the PLC side!

3.4.4.3 Startup OB 100

OB 100 is responsible for ensuring a correct startup of the PLC. OB 100 is called when the PLC is switched on. It can be correctly initialized simply by triggering a reset on the SPI3. Bit 4 of the condition code word must be set for this purpose (see OB 35, network 2, ANZW). This bit is automatically reset after the SPI3 has been reset.

OB 100 : "Startup"

Necessary for S7-300 and S7-400. The reset job for the SPI3 is started.

Network 1: Start reset job

If bit4 of M77 is set to 1 (see FB103/ANZW:=M76), a reset procedure is started. After a successful reset, bit4 is reset to 0.

```

U      M      77.4
ON     M      77.4
S      M      77.4           // Increment reset flag for SPI3

```

3.4.4.4 Restart OB 101 (S7-400 only)

The OB 101 is responsible for ensuring a correct restart of the PLCs in the 400 series. It should be included in addition to OB 100.

The information contained in section 3.4.4.3 applies here analogously. In particular, OB 101 is programmed identically to OB 100 (network 1 of OB 100 = network 1 of OB 101).

3.4.4.5 Programming Error OB 121

Since there is no way with the S7-300 of checking an existing DB, we use a small trick based on an error telegram instead:

OB 121 is called if an attempt is made to access a DB that does not exist. This OB generates an error telegram by overwriting DBB0 with 0xFF in DB_Send (in this case, DB 38 – see network 2 of OB 35):

OB 121 : "Programming error"

A programming error occurred.
In this example: Access to a non-existent DB.

Network 1: Send error to SPI3

Causes an error telegram to be sent to the SPI3.

```

AUF   DB      38
L     B#16#FF
T     DBB     0

```

3.4.4.6 Changing the I/O area

The following modifications are necessary before you can change the position or size of the module I/O area:

1. First of all, select the appropriate SPI3 module from the hardware catalog. To do so, replace Modul_C1CFCF01 with another module with the required I/O size (refer to section section 3.4.3, 4c). Please note the specification of your PLC!

The hardware catalog also contains other modules with different I/O sizes. Please pay attention to the I/O unit (BYTES/WORDS) which is used in the hardware configurator to specify the I/O size!

SPI3 module in hardware catalog	I/O size in bytes
Modul_C1C1C101	4
Modul_C1C3C301	8

Modul_C1CFCF01	32
Modul_C1DFDF01	64
Modul_C1FFFF01	128

- Set the start address of the module I/O area (by double clicking on the new module). Since the start addresses of the input and output are identical, we speak of a single I/O address.
- The I/O address specified in step 2 must now be entered in **OB 35** for network 1 and network 3. The following command:

```
LADDR := W#16#xxx // DP slave input/output address
```

must be changed accordingly for each network. Please note, however, that xxx must be entered here in HEX format.

- The length of the source and target areas of the useful data which is read/written must now be adapted in OB 35. Adapt the following command:

```
RECORD := P#M ?? .0 BYTE xxx
```

for xxx to the appropriate I/O size (see step 1) in network 1 and network 3 (decimal input). Change the following value in network 2 according to the new I/O length:

```
EA_Laenge := xx // Read / write length of the configured slave
```

- Finally, you must check whether the source and target areas for the useful data which is read and written overlap. These areas are set in OB 35 in network 2 with the two variables A_Anfang and E_Anfang. Adapt the areas there if necessary.
- The target area E_Anfang set in step 5 must moreover coincide with the target area in network 1, while the source area A_Anfang must coincide with the source area in network 3. Adapt the following commands:

```
RECORD := P#M xx .0 BYTE ???
```

for xx according to the settings in network 2.

Fig. 7 shows the relationship between addresses and I/O areas.

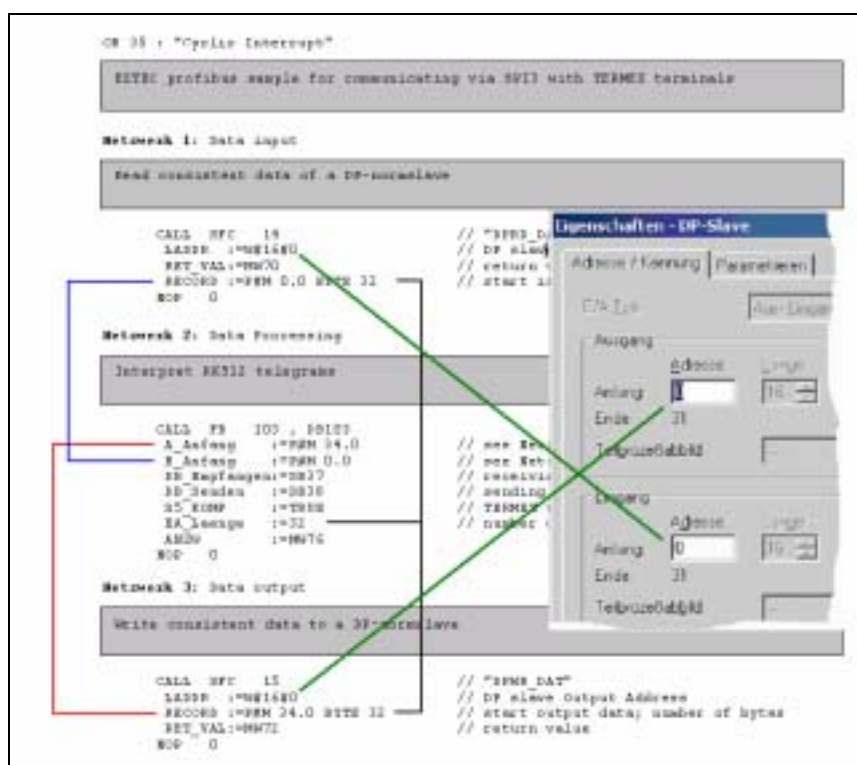

Fig. 7: Changing I/O area

3.4.5 Connection of several SPI3 DP slaves

How to connect two terminals via two SPI3 modules is described in brief below. Please note the following differences compared to communication with one terminal:

1. A second SPI3 module must be attached to the PROFIBUS in the Hardware Manager.
2. FB 103 (function block for sending and receiving telegrams using the RK512 protocol) needs a separate instance data block (in this example: DB 103 and DB 104) and two internal buffer data blocks (DB 37+38 and DB 39+40) for each SPI3 module that is attached to the PROFIBUS. You can thus duplicate the internal data blocks DB 37/38 and the instance data block DB 103 supplied by EXTEC with the copy and rename commands in the SIMATIC Manager.
3. The return values ANZW of the separate FB 103 calls must be set to different flag words.
4. The A_Anfang and E_Anfang addresses of the two DP slaves must be set to different ranges.

Refer to section 6.4 for a possible implementation of **OB 35** with two SPI DP slaves.

The same procedure applies analogously if there are more than two DP slaves. The maximum number of slaves is mainly determined by the available I/O area of the PLC.

3.5 Testing the demo projects

After you have successfully completed the hardware configuration of your S7 station, you can use the enclosed demo projects.

The demo projects are divided into two distinct parts: one part runs on the S7 and the other in the terminal.

Note: Please note that the demo projects described below (Ex315FB103 and Ex413FB103) use OB 1 to call FB 103 cyclically. We recommend the Ex315FB103OB35 project, however, as a starting point for user projects: this project calls FB 103 in OB 35. The communication speed is thus independent of the CPU cycle.

3.5.1 Loading a demo project in the S7

Open one of the two demo projects in the SIMATIC Manager parallel to your newly created project: Ex315FB103 (S7-300) or Ex413FB103 (S7-400).



Mark all blocks there in the S7 program directory (OB 1..., VAT 1) and copy them to your new project. If this does not work, please consult your S7 documentation.

Then set the rotary switch on the PLC to the **RUN-P** position, **reset** the CPU and load the **complete** (new) **project** in the S7.

The new project differs from the reference implementation described in section 3.4.4 in the following ways:

- FB 103 is not called together with SFC 14/15 in the timer OB (**OB 35**) but in the cyclic OB 1. OB 80 is therefore no longer required.
- FC 1, which copies the contents of DB2.DBW156 to data words DB2.DBW168, DB2.DBW180, ..., DB2.DBW396 (every 12 bytes), is new.

FC1 : Titel:

Copies DB2.DBW156 to DB2.DBW168, ..., DB2.DBW396 (step 12 bytes).
Equivalent on the TERMEX side to DW78, ... DW198 (step 6 words).

Network 1: Title:

Comment:

```

AUF DB      2
L      P#156.0
T      #Address          // Address := 156
L      0
T      #Step              // Step := 0

loop: L      #Address

```

```

LAR1
+AR1 P#12.0
TAR1
T #Address // Address += 12

L #Address
LAR1
L DBW 156 // Dopy DBW156 to DBW#address
T DBW [AR1,P#0.0]
L #Step
L 1
+I
T #Step // Increment step

L #Step
L 20
<I // Step<20? (or address>396)
SPB loop // Yes: Continue with loop
BEA // No: Copying finished// copy data

```

- FC 1 is called in network 4 of OB 1.

Network 4: Test function (for demonstration only!)

```
Copy DB2.DBW156 to DB2.DBW162, DB2.DBW168, ...
```

```

U M 77.1 // Return value of FB103: Sending telegram?
S M 200.0

U M 200.0
CALL FC 1 // Copy data

```

- The variable table VAT 1 for visualizing communication is new.

Notes:

- If you are working with another CPU and/or CP, you may need to adapt the OBs, FBs and DBs “manually” as described in section 3.4.4.
- If you set a communication data block other than DB 2 on the TERMEX 2xx/3xx/7xx (as in our example), you will have to configure this block in the PLC. Take data block DB 2 as a model and configure your communication data block in the same way.
- If you are using an S7-400 CPU, you should use the restart OB 101. Otherwise, communication problems may occur (refer to section 3.4.4.4).

3.5.2 Loading a demo project onto the terminal

The most important points to remember about TERMEX^{PRO} demo projects are outlined below:

- DW78 is configured in the demo projects as a SET variable, i.e. you can enter values on the keyboard.
- Data words DB84...DW198 are ACTUAL variables, i.e. these variables cannot be changed by user inputs. They simply serve to display values.

DW84, ..., DW198 of the data block (e.g. DB 2) that is mirrored in the terminal by the PLC, in other words, are only output whereas user inputs are made in DW78.

The demo projects have different start screens, depending on the terminal type (see Fig. 8-Fig. 10).

Please check the list below before you load a demo project onto the terminal:

- The EXTEC protocol must be activated in the terminal SETUP – if not, you cannot load a new project onto the terminal.
- The PC on which the demo project is installed must be correctly connected to the ENT-DC (or SK-LWL).
- The serial port of the terminal must be set to the following values: 19,200 baud, 8, even, 1.
- Load the demo project corresponding to the terminal type in TERMEX^{PRO} (refer to section 2.2).
- Compile the project and load it onto the terminal using the EXTEC Loader.

The ON LED (green) on the terminal lights up permanently and you see the start screen.

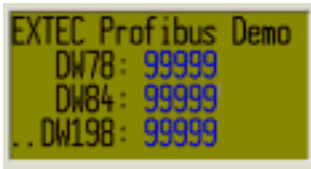

Fig. 8: TERMEX 220/320

T230cpu .exp			
Profibus Demo			
IN	78:99999		
OUT	78:99999	84:99999	90:99999
	96:99999	102:99999	108:99999
	114:99999	120:99999	126:99999
	132:99999	138:99999	144:99999
	150:99999	156:99999	162:99999
	168:99999	174:99999	180:99999
	186:99999	192:99999	198:99999

Fig. 9: TERMEX 230/330

Profibus Demo	
DW78: 99999	
DW78: 99999	DW98: 99999
DW102: 99999	DW114: 99999
DW126: 99999	DW138: 99999
DW150: 99999	DW162: 99999
DW174: 99999	DW186: 99999
DW198: 99999	

Fig. 10: TERMEX 770

Carry out the following steps after the demo project has been successfully loaded onto the terminal:

1. Change the protocol to **3964R/RK512** in the terminal SETUP.
2. Disconnect the serial programming cable of the PC from the ENT-DC (SK-LWL).
3. Instead, connect the ENT-DC (SK-LWL) to the SPI3 using a special cable (refer to sections 6.2.1.2 and 6.2.2.2).

You can now test communication between the terminal and the PLC:

- The two Rx/Tx LEDs blink on the ENT-DC (SK-LWL).
- The red COM LED goes out on the terminal.
- When you enter a value on the terminal and confirm it by pressing ENTER, this value appears in the other data words.

No communication errors will occur providing all three conditions are satisfied!

If not, please check points 1 to 3 above as appropriate. If communication errors still occur, refer to sections 3.6 and 4.

3.5.3 Visualizing the data exchange

Before you visualize the data exchange with the help of the variable table VAT 1 created in the SIMATIC Manager, you should check the following configuration:

- a) The PC must be connected to the MPI port on the S7 by means of the MPI adapter. The wiring arrangement should correspond to the schematic diagram in Fig. 1.
- b) The terminal must be set to the 3964R/RK512 protocol.
- c) The rotary switch on the PLC must be set to the RUN-P position.

The terminal should now be able to communicate correctly with the S7 CPU, i.e. on the SPI3:

1. If the PB LED is permanently lit => the PROFIBUS connection between the PLC and the SPI3 is functioning correctly.
2. If the RUN LED is permanently lit => communication between the SPI3 and the terminal is error-free.
3. If the Rx and Tx LEDs light each other => 3964R/RK512 telegrams are being transferred correctly.

Proceed as follows to visualize the data exchange:

- Open the variable table VAT 1 (by double clicking on VAT 1 in the tree view of the SIMATIC Manager: *SIMATIC XXX Station/CPU XXX/S7 Program/Blocks*).
- Make a connection to the directly connected CPU (select the following

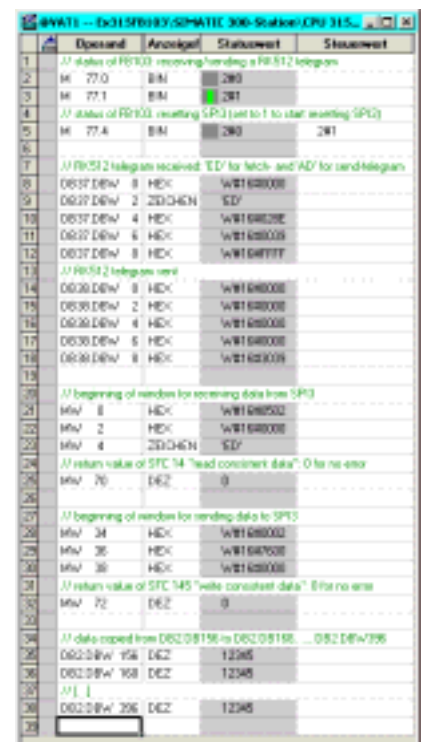

command in the main menu of the variable table: *Target System/Connect To/Directly Connected CPU*).

- Activate *Variable/Observe* to visualize the selected variables:
 - Flags M77.0 and M77.1 indicate reception or transmission of an RK512 telegram
 - DB 37 and DB 38 map the RK512 telegrams in the PLC
 - MW70/72 indicate the error states of read/write operations on the PROFIBUS
 - DB2.DBW156(396) corresponds to DB 78 (198) in the terminal

If a value is now entered on the connected terminal (DW78), the other data words shown on the display should have the same value after a few seconds.

The internal steps can be summarized as follows:

1. The value of DW78 is copied to the PLC (DB2.DBW156).
2. When FC 1 is called there, it copies this value to DB2.DBW168, ..., DB2.DBW396.
3. DB 2 is completely mirrored in the terminal and output there.

3.5.4 Optimum response times

As mentioned in section 3.4.4.1 above, the response speed¹ of the overall installation is determined by two main factors:

1. **Data transmission rate between the SPI3 and the terminal**

This speed is restricted to 19,200 baud by the technical specification of the terminals (exception: TERMEX 7xx with 57,600 baud).

2. **Number of interpretations of FB 103 together with calls of SFC 14/15**

The more interpretations that are possible in FB 103 per time unit, the more RK512 telegrams can be processed, in other words the number of data block synchronizations per time unit increases automatically. Conversely, fewer interpretations by FB 103 mean a delayed PLC response to the 3964R telegram received from the terminal.

Since the S7 programmer has very little influence on the maximum permissible data transmission rate between the SPI3 and the terminal, the only way to improve the response speed is to increase the number of FB 103 calls per second.

This can lead to problems, however, because too many FB 103 calls (together with SFC 14/15) are liable to place an excessive load on the CPU. If the CPU is insufficiently powerful or if the interpretations with FB 103 are inefficiently programmed, the response behavior will inevitably suffer.

Providing enough CPU time is available, however, the response speed (time to transfer data from the terminal to the PLC and back to the terminal) is likely to be around 1 second.

We strongly advise you to structure your S7 project in the same way as the Ex315FB103OB35 demo project:

FB 103 should be called together with SFC 14/15 in the timer OB (**OB 35**). 3964R communication via the SPI3 is thus independent of the CPU cycle times of OB 1.

Calling OB 35 every 10 ms represents an acceptable compromise between fast response times (1 s) and minimal CPU load due to communications (see hardware configuration: double click on CPU, cyclic interrupt of OB 35 every 10 ms).

Note:

The interval between two FB 103 calls should normally be between 5 and 50 ms in order to ensure an acceptable response time! Other values may be preferable in isolated cases.

3.5.4.1 *Subjective measurement based on the demo projects*

The demo projects supplied by us are designed to familiarize you with the principle of response times. Please note that these response times are the fastest achievable.

¹ Time required to transfer the data block from the terminal to the PLC and back to the terminal again

The delay between entering a value and filling in the table is approximately 1-2 seconds in this example if FB 103 is called every 5 ms.

3.5.4.2 Detailed measurements

Table 1 shows the typical response times for different FB 103 cycle times and baud rates between the terminal and the SPI3:

FB 103 Cycle [ms]	Response times [s] -- Modul_C1CFCF01 (32 bytes)					
	1200 baud	2400 baud	4800 baud	9600 baud	19200 baud	57600 baud
5	8	4	2,5	1,5	1	<1
18	8	5	3	2	1,5	1,5
60	10	7	5	4	4	4
125	13	10	9	9	9	9
250	20	19	19	19	19	19
410	31	31	31	31	31	31
500	36	36	36	36	36	36

Table 1: Response times with a constant module size

Note: A COM error occurs on the terminal with cycle times >500 ms.

The grayed fields show that the response time cannot be improved by increasing the baud rate. The call cycle of FB 103 is undoubtedly where the bottleneck occurs!

Once again, it is easy to see that the update rate is more important than the baud rate: there is no great benefit to be derived by increasing the baud rate from 19,200 to 57,600.

Poor response times are usually due to insufficient FB 103 calls. We recommend calling FB 103 at least every 10 ms.

Table 2 also reveals that the response time of the 64-byte module is no better than that of the 32-byte module. The 32-byte module is, however, clearly superior to the 8-byte module.

FB 103 Cycle [ms]	Response times [s] -- 19200 baud		
	8 bytes	32 bytes	64 bytes
	Modul_C1C3C301	Modul_C1CFCF01	Modul_C1DFDF01
4	2	1	1
16	4	1,5	1,5
64	10	4	4
256	Timeout	19	19

Table 2: Response times with a constant baud rate

It is thus possible to make the following unequivocal statement:

Modul_C1CFCF01 with a 32-byte I/O area offers the optimum response time in combination with EXTEC terminals! This module should therefore always be used.

3.6 Problems with the S7-Profibus-DP interface

You can find detailed troubleshooting instructions for the S7 interface in section **Fehler! Verweisquelle konnte nicht gefunden werden.** A few common problems are described here:

Problem	Cause	Remedy
The S7 CPU has the following LED states: <ul style="list-style-type: none"> ○ PB LED blinks ○ SF DP LED is lit ○ BUSF LED blinks (red) The CPU outputs the following message: <i>"Module is configured but does not exist"</i> .	<ul style="list-style-type: none"> a) The PROFIBUS-DP address on the SPI3 has been set incorrectly for the configured PROFIBUS-DP address. b) The PROFIBUS-DP address on the SPI3 was changed while the device was energized. 	<ul style="list-style-type: none"> a) Check the DP slave address of the SPI3 in the hardware configurator and if necessary match it to the DP address set on the SPI3. b) Disconnect the supply voltage briefly from the SPI3, then restore it again.
The device master file has been copied to the <i>Siemens/Step7/S7data/Gsd</i> folder as described in the manual. However, the SPI3 folder cannot be found in the hardware catalog.	The hardware catalog has not been updated.	Select <i>Options/Update GSD File</i> in the hardware configuration menu. You should then be able to locate the send and receive modules in SPI3.
The PLC and the SPI3 module appear to be functioning perfectly (the RUN+PB LEDs are lit on the SPI3), yet some of the values displayed on the terminal are incorrect. The message <i>"Communication Lost"</i> may appear on the terminal every few seconds.	<ul style="list-style-type: none"> a) Old SPI3 release b) Too many FB 103 calls 	<ul style="list-style-type: none"> a) Check the release (on the rear of the SPI3). Release 12 is OK. b) Call FB 103 at most every 5 ms (use the timer OB if necessary).
The red error LED on the S7-400 is lit and will not go out.	There is an error in the Siemens S7-400 CPU firmware.	Download new firmware from Siemens and install it in the module.
The following message appears at regular intervals in the diagnostic buffer of the S7: <i>"Standard slave module faulty"</i> .	The terminal is overloaded and cannot respond to 3964R telegrams within the specified time. This error occurs, for example, if a large number of windows are open in one screen [or windows with the "blinking" (on/off) attribute.	Try to optimize the screens (see Termex ^{PRO} Manual): <ul style="list-style-type: none"> a) Combine several windows into one (e.g. with inline variables). b) Avoid complex window operations (e.g. the window attribute "blinking").
S7-400: The PB LED is lit and the RUN LED blinks on the SPI3.	The SPI3 is not reset when the S7-400 is warm-started.	Include OB 101 as described in section 3.4.4.4.
Communication is interrupted after a power failure.	A power failure on the SPI3 causes the CPU to be switched to the STOP state if OB 86 does not exist.	Include OB 86 (no statements are necessary). Possibly also include OB 87 (communication error).
A <i>Communication Lost</i> error appears on the TERMEX 7xx.	The TERMEX 7xx uses 2 DBs but you created only one.	Create a second DB in the STEP 7 software.

4 Problems with the S7 interface

4.1 PROFIBUS connection between the PLC and the SPI3

Start by making the PROFIBUS connection between the PLC and the SPI3 module. It is assumed that:

- The PLC and the SPI3 are supplied with power,
- The PLC and the SPI3 are connected together by means of a PROFIBUS cable,
- The hardware configuration has been loaded into the S7 with the STEP7 software.

If the **PB LED** on the SPI3 lights up permanently, the PROFIBUS connection between the PLC and the SPI3 has been made correctly.

This means, in particular, that:

1. The DP master system has been parameterized correctly (refer to 3.4.3, especially 4h),
2. The DP slave address has been parameterized correctly on the SPI3 (refer to 3.4.3, especially 4c),
3. The PROFIBUS address has been set correctly on the SPI3 (refer to 3.4.2),
4. The PROFIBUS is wired correctly (terminating resistances, cable lengths etc.).

If, however, the PB LED blinks or if it does not light up at all, please check points 1-4 above.

Important: If the PROFIBUS address is altered on the SPI3, the SPI3 must be briefly deenergized. Otherwise, the new PROFIBUS address will not be accepted!

Fig. 11 is a table of PB LED blink codes that has been reproduced from the Trebing & Himstedt manual (SPI3 manufacturer). It contains useful information for diagnosing errors or faults.





LED off	LED short	LED medium	LED long	LED on
				
LED always off	LED is 1/4 off 1/4 on	LED is 1/2 off 1/2 on	LED is 3/4 off 1/4 on	LED always on
PB LED code	Status	Significance	Remedy	
PB LED off	Correct data transfer rate could not be determined	– No PROFIBUS master in the network	– Connect up the DP master – Check the wiring	
PB LED short	No DP master available	– A master is available but it is not a DP master – A master is available but communication is not taking place with PROFIBUS-DP	– Check DP configuration of the master – Check address setting on the SPI 3	
PB LED medium	Incorrect parameter	– Parameter telegram faulty	– Check the DP parameter telegram, use the correct GSD file	
PB LED long	Incorrect configuration	– Configuration telegram faulty	– Check the number of modules (only one module is allowed in the configuration)	
PB LED on	Data exchange OK	– Data exchange is currently taking place	– SPI 3 working correctly	

Fig. 11: Blink codes of the PB LED on the SPI3

4.2 Serial connection between the SPI3 and the terminal

Now make the serial connection between the SPI3 and the terminal. It is assumed in the following that:

- The PLC, SPI3, ENT-DC (SK-LWL) and terminal are supplied with power,

- The PB LED on the SPI3 is permanently lit (refer to section 4.1),
- The SPI3 is correctly wired to the ENT-DC (SK-LWL) buffer stage,
- The terminal is correctly connected to the ENT-DC (SK-LWL).

If the **Rx LED** lights up intermittently on the SPI3, the physical connection between the terminal and the SPI3 has been made correctly.

If, on the other hand, the Rx LED does not flicker at all, please check the following points:

1. The terminal and the ENT-DC (SK-LWL) must be supplied with **power**,
2. The **active protocol** for the terminal must be set to 3964R/RK512 (refer to sections 6.1.1.2 and 6.1.2.2),
3. The **cable** between the terminal and the ENT-DC (SK-LWL) must be connected.

The most important question here is: Does the Rx LED on the ENT-DC (SK-LWL) flicker? If not, check the wiring between the terminal and the ENT-DC (SK-LWL). If in doubt, use only EXTEC connecting cables.

It is assumed in the following that the Rx LED on the SPI3 is flickering, in other words the physical connection between the terminal and the SPI3 has been made correctly.

If the **RUN LED** on the SPI3 lights up permanently, the serial port parameters between the SPI3 and the terminal have been set correctly.

This means that the interfaces of the SPI3 and the terminal have been set correctly: the baud rate, parity and stop bit settings are correct both in the SPI module on the PLC side and in the terminal SETUP.

If, on the other hand, the RUN LED blinks, the blink codes described in **Fig. 12** could provide assistance:

RUN LED code	Status	Significance	Remedy
RUN LED off	SPI 3 not ready	– 24 V supply not present	– Check external power supply – Check the wiring
RUN LED short	Interface error	– Interface parameters invalid	– Check the parity (e.g. you have chosen 7 data bits without parity although 7 data bits requires parity)
RUN LED medium	Send error	– Error when sending	– Check the wiring – Check whether the partner station is ready (this error should only occur with 3964 and derived protocols)
RUN LED long	Receive error	– Error when receiving	– Check character format and data transfer rate of partner station
RUN LED on	Communication OK	– Serial partner communicating correctly with the SPI 3	– SPI 3 working correctly

Fig. 12: Blink codes of the RUN LED on the SPI3

4.3 Including and accessing the SPI3 module

This section describes how to ascertain whether the RK512 interpreter on the PLC is interpreting correctly. It is assumed in the following that:

- The PROFIBUS connection between the PLC and the SPI3 (refer to section 4.1), and

- The serial connection between the SPI3 and the terminal (refer to section 4.2),

are functioning correctly.

With regard to the LEDs on the SPI3, this means that PB and RUN are permanently lit while Rx and Tx flicker (lit intermittently).

Note: The Rx LED flickers because the terminal polls the communication data block of the PLC in its role as 3964R/RK512 master.

The data, which is already present on the PROFIBUS, must now be further processed as follows (please check each point in the list and compare with demo projects):

1. SFC 14, FB 103 and SFC 15 must be called in OB 1 (or OB 35) (refer to section 3.4.4.1)
2. The load addresses (LADDR) of SFC 14/15 must coincide with the I/O addresses of the configured DP slave (in this case: SPI3) (refer to section 3.4.3, para. 4e and section 3.4.4.6, para. 3 with **Fig. 7**)
3. The correct DP slave module must be installed; we strongly advise the module that sends/receives 32 bytes: Modul_C1CF01_____!
4. The source and target areas of SFC 14/15 must be sufficiently large without any overlap and they must coincide with the call in FB 103 (see **Fig. 7** in section 3.4.4.6)
5. All the required DBs must be defined
6. The CPU must not have been switched to the STOP state

Note: The variable table VAT 1 supplied by us may provide useful troubleshooting assistance.

If, after carefully checking all the above points, communication between the SIEMENS PLC and the TERMEX terminal still does not work, please contact either **Trebing & Himstedt GmbH** or **SIEMENS AG** directly.

Company	Internet address
EXTEC Oesterle GmbH	www.extec.de
Siemens AG - Automation and Drives	www.ad.siemens.com
Trebing & Himstedt GmbH	www.t-h.de

5 S5-PROFIBUS interface

With the S5-PROFIBUS interface, the master and slave are configured using the **COM-Profibus** tool. COM-Profibus Version 3.1 supports the existing device master file. One minor modification is necessary for Version 5.0, however: the `User_Prm_Data_Len` parameter in the device master file must be changed from 32 to 20 to avoid problems with the configurator. (T&H)

The hardware configuration is identical to that for the S7-PROFIBUS interface.

The data exchange software is included with the example supplied by EXTEC. It is designed for a CPU941 with an IM308C communications module. Various FBs for 2 or 4-word transmission with the ASCII or 3964R/RK512 protocol are also enclosed.

Since there are only a few functionalities that support the DP interface for this CPU (e.g. regarding the restart characteristics), you should reload the interface configuration data into the CPU if you encounter any problems. Please also check the following points:

1. Test the LED for the backup battery and replace it if necessary (the configuration data is lost).
2. In DB 1: Either reset the DP parameters or set them to *No*.
3. Wait until the master is switched on before calling communications modules.
4. If none of this helps, try reloading the configuration data for the DP interface into the CPU.

6 Appendix

6.1 Communication settings

6.1.1 TERMEX 2xx/3xx

6.1.1.1 Change port parameters

We recommend setting the following port parameters in order to operate the terminals on the PROFIBUS with the SPI3:

- Baud rate: 19200
- Parity: Even
- Data bits: 8
- Stop bits: 1

Proceed as follows to change the serial port settings on the terminal:

1. **Trigger a reset**

You can trigger a reset directly on the terminal at any time with the following shortcut:

<SHIFT↑> <ENTER> 9

2. **Change to the terminal SETUP**

Press <SHIFT> F1 when the power-up message is displayed.



This takes you directly to the SETUP MAIN MENU.

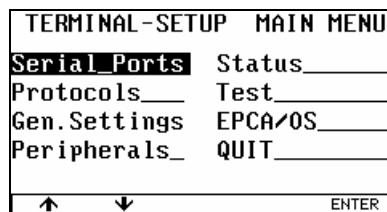

3. **Set the serial port**

Press ENTER to select the marked "Serial_Ports" field.

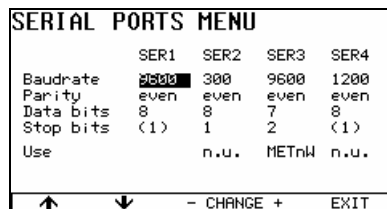

6.1.1.2 Change protocol

The protocol type must be changed to **3964R/RK512** in order to operate the terminals on the PROFIBUS with the SPI3. Proceed as follows to do so:

1. **Trigger a reset**

You can trigger a reset directly on the terminal at any time with the following shortcut :

<SHIFT↑> <ENTER> 9

2. **Change to the terminal SETUP**

Press <SHIFT> F1 when the power-up message is displayed.



This takes you directly to the SETUP MAIN MENU. Use the cursor keys ↓ (F2) to mark “Protocols” as the active field instead of “Serial_Ports” (active = inverse representation):

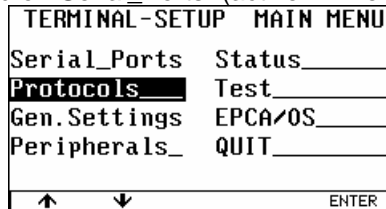

3. **Set the 3964R/RK512 protocol**

Press **ENTER** to select the marked “Protocols” field. This opens the PROTOCOLS MENU, in which you can select one of the protocols that are operated at SER1 (- **CHANGE** + changes the values in the active field):

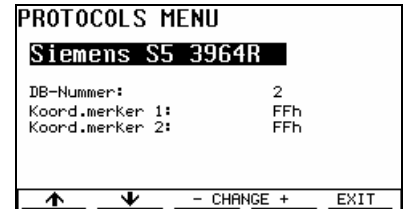
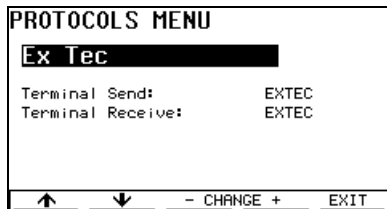

Change the active protocol to 3964R/RK512.

4. **Select a data block**

The 3964R/RK512 protocol describes communication with a (Siemens) communication module according to the 3964R procedure (RK512 interpreter). The number of the communication data block that is used in the PLC must be set as the **DB number** (2...255). The default values of the two coordination flags (FFh) should not be changed.

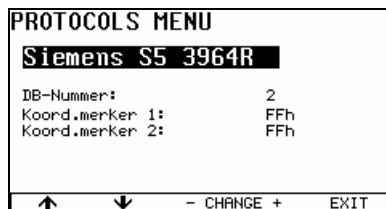

5. **Close the terminal SETUP and save the new settings**

EXIT (F5) exits the “Protocols” menu. QUIT in the main menu followed by “Save changes” saves the new settings permanently.

6.1.2 TERMEX 7xx

6.1.2.1 Change port parameters

We recommend setting the following port parameters in order to operate the terminals on the PROFIBUS with the SPI3:

- Baud rate: 19200 (max. 57600 baud)
- Parity: Even
- Data bits: 8
- Stop bits: 1

Proceed as follows to change the serial port settings on the terminal:

1. Trigger a reset

You can trigger a reset directly on the terminal at any time with the following shortcut:

<SHIFT↑> <ENTER> 9

2. Change to the terminal SETUP

Press F1 when the power-up message is displayed. This takes you directly to the SETUP MAIN MENU.



3. Set the serial port

Press F5  to go directly to the SERIAL PORTS MENU.

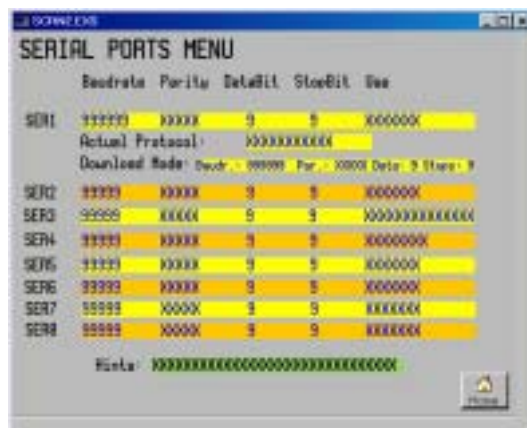

You can specify both the settings for each serial port and the active protocol via serial port 1 in this menu.

6.1.2.2 Change protocol

The protocol type must be changed to **3964R/RK512** in order to operate the terminals on the PROFIBUS with the SPI3. Proceed as follows to do so:

1. **Set the active protocol**

Start by carrying out steps 1-3 as described in section **Fehler! Verweisquelle konnte nicht gefunden werden.** When the SERIAL PORTS MENU opens, set the active protocol to 3964R/RK512 and close the menu again!

2. **Protocol-specific setups**

Now select the "Protocols" command in the SETUP MAIN MENU:



This opens the PROTOCOLS MENU, in which you can set the number of the communication data block (2..255). The default values of the two coordination flags Coord. Flag 1 and 2 (FFh) should not be changed.

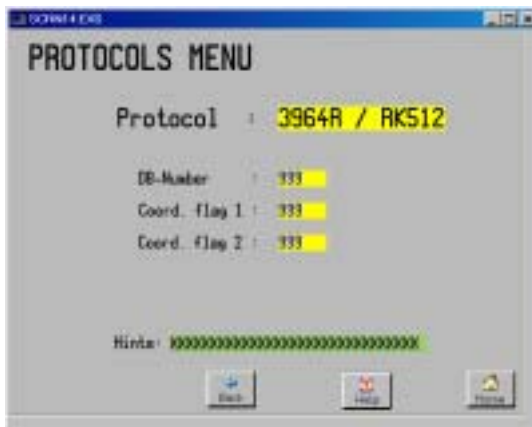

Note: Please note that (unlike the TERMEX 2xx/3xx) the TERMEX 770 has two data blocks: the data block specified in the SETUP and the continuation data block. Don't forget to create the continuation data block in your PLC as well!

3. **Close the terminal SETUP and save the new settings**

Don't forget to close the SETUP and save the new settings.

6.2 Connecting cables

6.2.1 TERMEX 2xx/3xx

6.2.1.1 S-ENT/PC-9

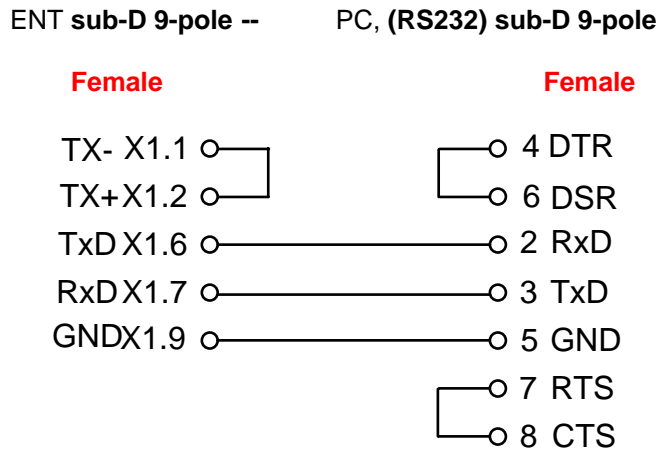

Note:

The Tx jumper for the 20 mA interface in the ENT-DC-1 must be set to "active".
The Rx jumper setting is not relevant (see ENT-DC Technical Manual).

6.2.1.2 S-ENT/SPI3

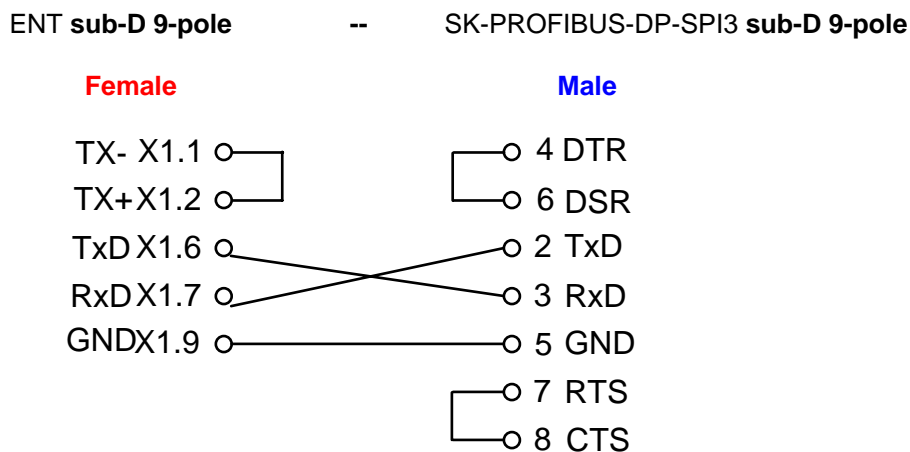

Note:

The Tx jumper for the 20 mA interface in the ENT-DC-1 must be set to "active".
The Rx jumper setting is not relevant (see ENT-DC Technical Manual).

6.2.2 TERMEX 750

6.2.2.1 S-TERM/RS232-PC-M25-F9

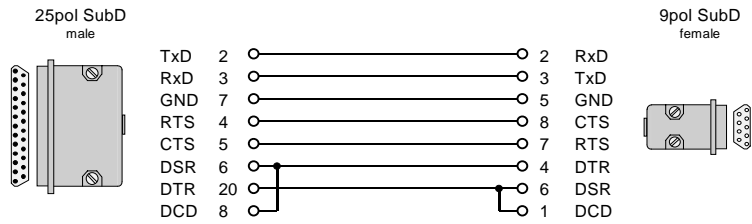

Suitable for connecting:

SK-LWL, X1 host interface (TERMEX 7xx) <-> PC (RS232)

6.2.2.2 S-TERM/RS232-DE-M25-M9

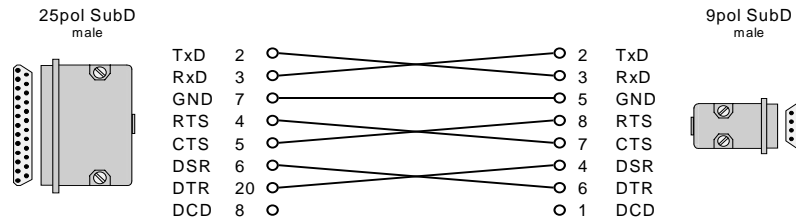

Suitable for connecting:

SK-LWL, X1 host interface (TERMEX 7xx) <-> SK-PROFIBUS-DP-SPI3

6.3 Block diagrams

6.3.1 TERMEX 2xx/3xx connected to ENT-DC

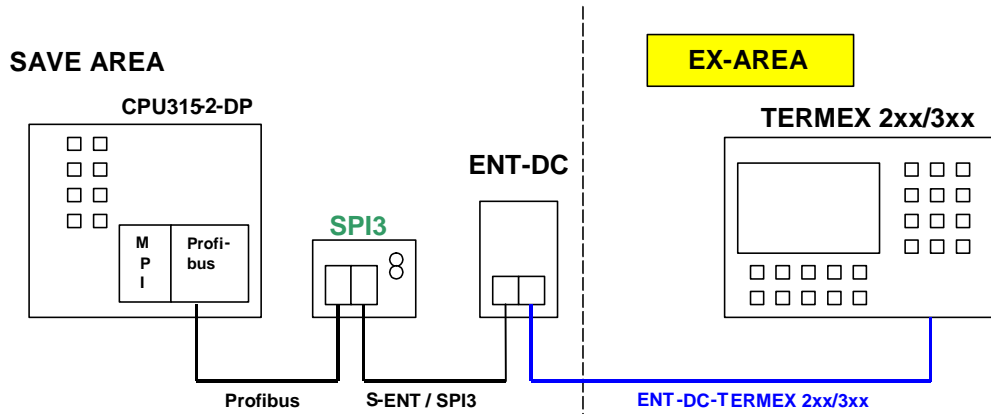

6.3.2 TERMEX 750 connected to SK-LWL

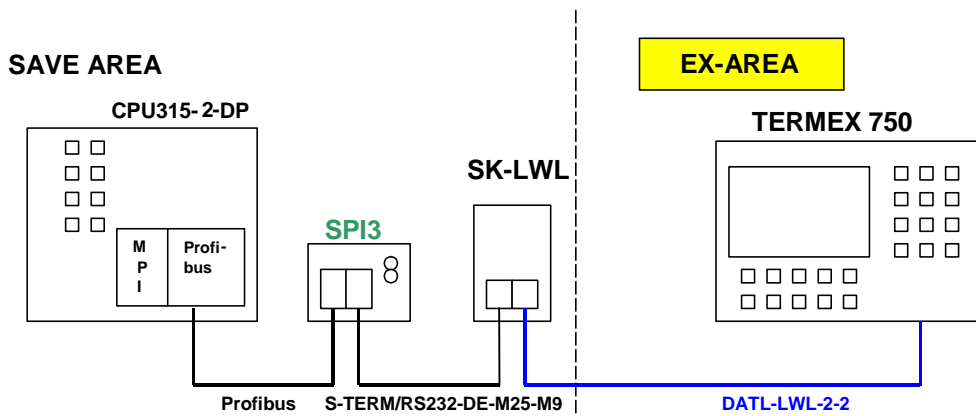

6.4 Communication with 2 SPI3 DP slaves

OB 35 : "Cyclic interrupt"

Network 1: Data input - SLAVE 1

Read consistent data of a DP norm slave

```
CALL SFC 14 // "DPRD_DAT"
LADDR :=W#16#0 // DP slave input address
RET_VAL:=MW70 // Return value
RECORD :=P#M 0.0 BYTE 32 // Start input data; number of bytes
NOP 0
```

Network 2: Data processing - SLAVE 1

Interpret RK512 telegrams

```
CALL FB 103 , DB103
A_Anfang :=P#M 34.0 // See network 3: input data
E_Anfang :=P#M 0.0 // See network 1: output data
DB_Empfangen:=DB37 // Receiving buffer
DB_Senden :=DB38 // Sending buffer
S5_KOMP :=TRUE // TERMEX uses S5 addressing mode
EA_Laenge :=32 // Number of bytes to process
ANZW :=MW76
NOP 0
```

Network 3: Data output - SLAVE 1

Write consistent data to a DP norm slave

```
CALL SFC 15 // "DPWR_DAT"
LADDR :=W#16#0 // DP slave output address
RECORD :=P#M 34.0 BYTE 32 // Start output data; number of bytes
RET_VAL:=MW72 // Return value
NOP 0
```

Network 4: Data input - SLAVE 2

Read consistent data of a DP norm slave

```
CALL SFC 14 // "DPRD_DAT"
LADDR :=W#16#20 // DP slave input address
RET_VAL:=MW80 // Return value
RECORD :=P#M 96.0 BYTE 32 // Start input data; number of bytes
NOP 0
```

Network 5: Data processing - SLAVE 2

Interpret RK512 telegrams

```
CALL FB 103 , DB104
A_Anfang :=P#M 128.0 // See network 3: input data
E_Anfang :=P#M 96.0 // See network 1: output data
DB_Empfangen:=DB39 // Receiving buffer
DB_Senden :=DB40 // Sending buffer
S5_KOMP :=TRUE // TERMEX uses S5 addressing mode
EA_Laenge :=32 // Number of bytes to process
ANZW :=MW86
NOP 0
```

Network 6: Data output - SLAVE 2

Write consistent data to a DP norm slave

```
CALL SFC 15 // "DPWR_DAT"
LADDR :=W#16#20 // DP slave output address
RECORD :=P#M 128.0 BYTE 32 // Start output data; number of bytes
RET_VAL:=MW82 // Return value
NOP 0
```