



Fieldbus Diagnostics

***“Fieldbus
made visible”***

Fieldbus Diagnostics

***“Fieldbus
made visible”***



Preface

No PAM without ADM...

Prof. Klaus Bender

*Head of the Institute of Information Technology at the TU Munich and
Chairman of the Profibus User Organization*

The future is digital!

Dr.-Ing. Gunther Kegel

CEO of Pepperl+Fuchs GmbH

Availability as the primary cost-driving process

Dr. rer. nat Christine Eckert, Journalist, Communication for science and technology

Control is better than Confidence

Dr. rer. nat Christine Eckert, Journalist, Communication for science and technology

Accelerated Commissioning

Dr. rer. nat Christine Eckert, Journalist, Communication for science and technology

User Statements

Dr. Thomas Hauff, Group Leader, Automation Center, BASF

*Oliver Weigel, Member of the automation center and European contact on the theme of the Fieldbus
in the technical community at BASF and member of the NAMUR Working Group 2.6 – Fieldbus*

Wilfried Schmieder, Engineering Additives – Frankfurt Chemesty, Sanofi-Aventis

Michael Klein, Administrator Automation at Sanofi-Aventis

*Dr. Niels Kiupel, responsible for control and instrumentation
at the Degussa coatings & colorants plant at Herne/Witten*

*Michael Pelz, EMR Operations Engineer in the Pigments & Additives Division of Clariant Products (D)
and Chairman of NAMUR Working Group 2.6 – Fieldbus*

*Sven Seintsch, Test Laboratory BIS Process Technology in the Höchst Industrial Park,
Working Group Leader, Fieldbus of the IGR (Community of interests – Control Systems Technology)*

Dr. Thomas Tauchnitz, Manager EMR Planning for Frankfurt Injectables with Sanofi-Aventis

The Fieldbus, the unknown entity?

Interview with

Dipl.-Ing. Jürgen George, Manager Marketing and Stratetic Planning, Pepperl+Fuchs GmbH

Interview

Dr. Gunther Kegel, Member of the Fieldbus Foundation Board of Directors

Jörg Schneider, Chairman of Working Group Sales & Marketing of PACTware Consortium e.V.

Methods for Planning, Installation, Commissioning and Diagnosis of Fieldbus Installation

Andreas Hennecke, Product Marketing Manager Fieldbus Technology, FieldConnex®, Pepperl+Fuchs GmbH

*Sven Seintsch, Test Laboratory BIS Process Technology in the Höchst Industrial Park,
Working Group Leader, Fieldbus of the IGR (Community of interests – Control Systems Technology)*

Thomas Kasten, Marketing Communication Manager, Pepperl+Fuchs GmbH

In control of Fieldbus – Advanced Diagnostic Module for the FieldConnex® Power Hub System

Thomas Kasten, Product Marketing Manager Fieldbus Technology, FieldConnex®, Pepperl+Fuchs GmbH





Preface

No PAM without ADM...

... or “You cannot improve what you cannot see,” postulated John Berra, president of Emerson, in his Plant Asset Management (PAM) presentation at the NAMUR annual conference 2006. Indeed, new types of progressive functions in the control systems are required for this “seeing” of specific changes in production plants. But unfortunately, without adequate instrumentation technology, the plant changes will not be recognized until it is far too late. Predictive maintenance to increase plant availability and hence improve profitability – one of the most important prerequisites for industrial production in countries with high wage bills – can only recommend far-sighted measures if it can actually “see” and diagnose the changes.

Traditionally, this diagnosis is focused on the classical process technology. It makes sense for reasons of cost to use the existing installed measuring stations, even for the plant diagnosis. But the plant parameters of most interest for the PAM are those that cannot be easily acquired with the standard instrumentation technology, but which can be calculated, for example, using suitable models. If necessary a number of PAM-specific measuring stations must be added in order to gain a complete “view” of the plant and to facilitate an evaluation of the plant characteristics. So much for the state of the art.

In the assessment of the wear of plant components the focus must not only closely spotlight the mechanics and the sensor systems. The electrical systems also change due to ageing, corrosion, electromagnetic effects in the environment and mechanical loading. In respect of the conventional 4 ... 20 mA technology with its point-to-point connection, which can only be monitored with difficulty and expense, the introduction of the digital fieldbus has now brought enormous progress in terms of accuracy, EMC faults and also monitoring capability. Indeed the bus has become a central and therefore critical plant component, but many measuring systems are connected to it and so the bus monitoring costs have to be related to this context.

Of course it requires specific know-how for the systematic diagnosis of physical fieldbus quality parameters, such as signal jitter and noise, dynamic signal level, terminating resistances and contact problems.

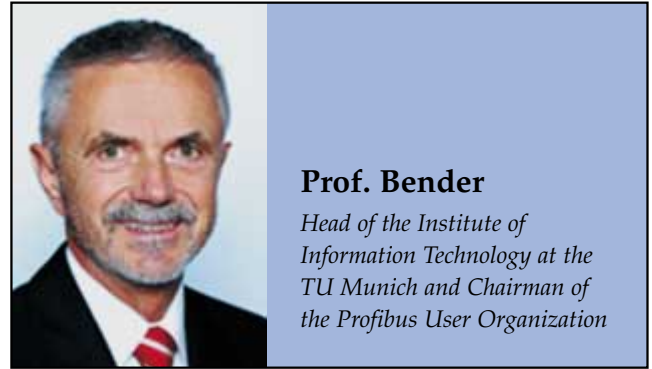

Prof. Bender

Head of the Institute of Information Technology at the TU Munich and Chairman of the Profibus User Organization

Also the human factor contributes to undesired changes during maintenance work and extensions. Reversed connections, forgotten connections, incorrect or poor contacts must be detected and signaled immediately in order to avoid plant stoppages.

Now, with the Advanced Diagnostic Module (ADM) Pepperl+Fuchs has set the standard and closed a gap in the continuous monitoring of the most important physical quality parameters of IEC 61158-2 standardized fieldbuses in process technology. The ADM „sees“ continuously the electrical and periodic behaviour of the whole bus system and also that of all the connected components in all life cycle phases of the production plant. Thus the ADM can immediately establish both planning and installation faults at the commissioning stages and also during maintenance and extension work. It also discovers creeping signal changes due to unavoidable wear so early, that in the context of preventive maintenance work the cause of the fault can be eliminated in good time before a plant stoppage is involved.

Naturally enough, the ADM does not come without cost. But this relatively small investment at a centralized location so obviously increases plant availability, that the economics of the system are easily demonstrated. Because “you can only improve what you can see”. A powerful Plant Asset Management system must also see the fieldbus, therefore ...

... no PAM without ADM!



The future is digital!

Published in atp 11/2006

It's over: At this year's photokina there were no innovations for analog cameras – photography is now exclusively digital. It will become ever more difficult in the future for the lovers of conventional analog cameras to just pop out and purchase a color film from the kiosk around the corner, let alone select a film with a particular light sensitivity. And in other areas of technology the same trend is apparent: Digital telephones, digital music, digital television, etc.



And process automation? The stubborn conviction to resist the use of digital communication on the field level persists in this area. The 4 ... 20 mA interface is not only an operating byword; its future seems secure. Will the manufacturers of field devices be able to drive on innovations independent of considerations of the interface? Are multi-sensor field devices, which are integrated into autonomous decentralized control circuits and exchange complex maintenance and diagnostic data conceivable without digital communication? Well, hardly – even the future of field devices in process automation is digital. The component costs for analog signal transfer and calibration already exceed the costs of powerful micro-controllers, which not only image the digital communication, but above all represent the platform for the implementation of innovative product ideas.

The idea that with the introduction of digital technologies the overall system complexity always increases significantly is also a fallacy. Complexity arises due to unsatisfactorily defined interfaces within the automation systems and, above all, between these systems and the user. Technology must, on the contrary,

be used to provide a deeper knowledge for some users without overloading other user groups with information in the process.

The diagnosis of the physical layer of a fieldbus system serves as an almost perfect example. Some extol the virtue of the analog 4 ... 20 mA philosophy which, on account of its robust nature, did not at first require a diagnosis of the physical transfer, while others complain about the profusion of electrically measured values and transfer data, which provides the diagnosis of the fieldbus physics. Both are on the wrong track! On the one hand, even a 4 ... 20 mA transfer device must be calibrated many times during its life to ensure the highest accuracy and on the other hand a correctly designed operating interface reduces the diagnosis and alarm signaling for the plant operator to an absolute minimum and provides the automation engineer equipped with the appropriate knowledge access to a large amount of additional data.

The future of field device interconnection is digital, but not necessarily more complex.

Dr.-Ing. Gunther Kegel
CEO of Pepperl+Fuchs GmbH
Mannheim



Availability as the primary cost-driving process

Fieldbus Diagnostics minimizes plant shut-downs

The days in which automation was primarily seen as a means to increase profits by reducing staff costs, are definitely over, emphasized Dr. Norbert Kuschnerus, president of the Namur board of directors in his opening words at the 2006 annual conference. Speaking about asset management, he added: "Today, it is possible to optimize production processes, as well as all cost and profit related parameters. Especially in regions with expensive and highly qualified personnel, optimization of production processes is vital and a key factor to maintain and increase international competitiveness."

According to Namur, automation system providers are in a position to make an essential contribution to these goals. Despite the fact that in 2001 already, Namur has published respective recommendations, plant asset management is still at its beginnings. Already at the annual conference in 1997, this year's sponsor, Emerson Process Management – at that time still known as Fisher Rosemount – has made participants familiar with this subject. Yet, as a filled house with 450 conference atten-

dees indicated, interest in asset management still seems to be at as high as ever.

Uncover the Invisible

Generally speaking, asset management and the related activities are used to maintain and increase the value of manufacturing equipment across its complete life cycle. With plant-oriented asset management, everything focuses on continuous operation. Several Namur representatives have tried to find a precise definition and came up with the conclusion that plant asset management includes everything from monitoring and maintaining the target functions of all components to forecasting and securing availability and minimizing repair costs on the basis of specified values and models. This puts the system components and not the process itself into the center of attention. Added value is primarily expected by securing availability and minimizing maintenance costs.

To reach these goals, plant operators need additional "eyes and ears". It is, as Berra, president of Emerson Process Management, stated in his presentation: "You cannot improve, what you cannot see." With these words,

he addressed exactly the point, where the Advanced Diagnostic Module for fieldbus diagnostics from Pepperl+Fuchs comes in. According to one of our colleagues, this module may be viewed as the small brother of asset management. Small but smart, since fieldbus diagnostic is able to offer insight into the physical layer of the fieldbus, thereby visualizing the actual foundation of digital communication. It is able to detect installation errors during commissioning and generates an alarm, as soon as typical fieldbus parameters reach a critical threshold.

Test results proving the point

During the first afternoon workshop, Michael Pelz, representative of the work group 2.6 fieldbus, reported about a project, dalled "Diagnosis and troubleshooting at the physical layer of fieldbus systems" and informed of the results gained by the Rheinhold & Mahla test laboratory. Replacing Sven Seintsch, who could not attend the meeting due to illness, Pelz reported that fieldbus diagnostics passed the acid test in the laboratory with excellence

and proved to be absolutely stable when faced with simulated "initial faults", such as EMC faults or installation errors like a missing terminator. No aging symptoms were observed during the test period. "I visited the test laboratory repeatedly and observed how they put the segments under stress", Pelz explained: "They carried out all kinds of examinations to determine the "tolerance limit" of a bus system. I did not expect such a positive result and I am really glad about it." Actual problems with the bus were only encountered with a combination of several errors. This means that a solid installation without hidden initial faults is the best basis for a stable system. In addition, such a solid installation needs to be demonstrable for the user. Starting the right way during the commissioning phase will result in a reliable fieldbus ready for further expansion.

Another aspect of fieldbus diagnostic is monitoring the facilities during expansions or modifications. It allows the user to verify immediately whether all values are as good as before or whether a problem has been introduced. The testlab at the



Industriepark Höchst has used the tool to analyze 200 actual Profibus PA and Profibus FF segments.

Another interesting aspect is integration of fieldbus diagnostics in the power supply, as the work group manager explains: "This enables predictive maintenance, meaning, the diagnosis tools are active online, making regular manual verifications obsolete. The systems will only generate an error message, if jitter, noise, or other quality parameters exceed certain thresholds."

The ideal procedure consists of defining reasonable thresholds, verifying the bus, setting it into operation and then forgetting it, as far as maintenance is concerned. The Namur work group analyzing fieldbuses considers the use of diagnostic tools to be very useful and plans to initiate a corresponding recommendation. "One of our plants has been working without any problem for one year. Yet, by using the diagnosis tool, we were able to discover some of the indicated initial faults," admitted Pelz, EMR engineer of the Pigments & Additives Division of Clariant Produkte (D), in a subsequent discussion. He added: "We are very satisfied with the stationary version which was retrofitted for test purposes. That's why we will keep the installation by all means and can also recommend it for the future."

Better now than too late

The diagnosis of the physical layer of fieldbus systems met a high level of interest at the annual Namur conference and resulted in positive feedback. Sanofi-Aventis contracted Reinhold & Mahla as service provider to check some of their plants for faults. "In a way, the physical layer is the telephone wire which transmits the data. If it does not perform correctly, we don't even need to think about other applications," explained Dr. Thomas Tauchnitz. He is manager of EMR planning for Frankfurt Injectables at Sanofi-Aventis and carries the golden honor pin of Namur since last year. "The diagnosis is vital in order to be sure that the physical layer performs not simply sufficiently but with long-lasting reliability. Especially after major changes or modifications, I consider checking it as an absolutely necessary." Dr. Niels Kiupel, responsible for the EMR of Coatings & Colorants in the Degussa Herne/Witten plant, knows the tool from Pepperl+Fuchs from practical applications. He plans to use the tool for all new fieldbus systems or plant expansions. "The diagnosis of the physical layer is of vital importance for us, since it represents the only real chance to detect errors at fieldbus level," stated Kiupel. "Conventional analyses via current and voltage

measurements are of no real help. If there is no diagnosis, one is left to trial and error if the fieldbus does not work any more." In our digital age this represents a rather antiquated method. Especially so, since plant asset management targets at increased availability as the primary factor to increase the value of a production system. Dr. Thomas Hauff, group manager at the Center for Automation Systems of BASF AG, considers reduced commissioning time and constant monitoring during operation to be of vital importance for diagnosis of the physical layer: "The user purchases the device and does not require separate measurements during commissioning because the complete branch is already monitored constantly. Consequently, the operator will get the permanent benefit at reduced cost, since a part of the investment already paid off during commissioning."

One Shutdown avoided will make a difference

Despite all benefits, it must be expected that the added costs caused by the diagnosis modules will be a point of discussion during the planning phase. Dr. Gunther Kegel, Managing Director at Pepperl+Fuchs, takes a very pragmatic position: "One cannot define an asset management System (AMS) – and Advanced Diagnostic is part

of it – via the investment costs. Formerly, there was no AMS, and even if I would sell it for 1 Euro it would represent increased costs. The primary issue is: How many shut-downs will be avoided by the tool?" Therefore, most presentations at the Namur conference centered around life cycle costs. Added costs will payback soon, if the user is able to use diagnosis of the physical layer to detect such problems as cable degradation, humidity penetration and detachment of cable shields at an early stage. "Some of the world's biggest refineries will loose up to 17 billion dollars during a shut-down of one day only. This easily demonstrates how much system operators could actually invest into fieldbus diagnostics to only avoid one single shutdown," explained Kegel. He added: "Naturally, nobody will calculate in such a way, but the example demonstrates that discussions are actually turning into the wrong direction."

*Dr. Christine Eckert
Journalist, Communication
for science and technology*

Phone +49 6151 272771
christine.eckert@t-online.de

Control is better than Confidence

Diagnostic tool makes the fieldbus transparent and increases availability

Physical Layer of the Fieldbus made Transparent

Diagnostic tool allows a predictive maintenance and leads to an increased availability

Up until now, fieldbus has been relatively unknown. Existing users did not have a tool which would make the physical layer of the fieldbus visible and which would also highlight and provide solutions to any problems, occurring. For 4...20 mA signals, there are enough software and hardware tools to spare, but it is only the fieldbus which allows an economical monitoring of the physical layer. The Advanced Diagnostic Module by Pepperl+Fuchs facilitates the handling with digital communication and creates confidence in the technology. Thanks to predictive maintenance, the plant availability can be substantially increased.

Similarly to conventional technology, the fieldbus uses modulations of current to transfer information and also energy. Since several devices use the same cable, the signals have to be transmitted in data packages. With the Advanced Diagnostic Modules (ADM), Pepperl+Fuchs has launched a tool which simplifies signal tracing, allows a timely interpretation of signal changes and the installation of a predictive maintenance program. The manufacturer offers the module as an option for power supply systems. This module is able to simultaneously and constantly monitor up to four segments.

Small but Smart

For a long time, field devices have been furnishing information on their own status. In many cases, the precise knowledge of all device data already allows predictive maintenance. The user knows exactly, for example, that a certain valve has to be checked within six months at the latest. Today, the process control systems dispose of several diagnostic functions. They can recognize, for example, whether all data packages or telegrams reached the control system or whether a field device excluded itself from the cyclic data traffic however, the cause for the loss of the telegram remains concealed. This is where the diagnostic module from Pepperl+Fuchs becomes advantageous. The clever software monitors the piece of fieldbus for which, an adequate tool has not previously been in existence: the physical layer which is responsible for the communication between the field device and the DCS. In the past, the user could only react and take corresponding measures after they had encountered a problem. In addition, for fault diagnosis, it was required to bring



Dr. rer. nat Christine Eckert

*Journalist, Communication
for science and technology*

several pieces of equipment on site, such as a simple voltmeter and an unmanageable oscilloscope. Pepperl+Fuchs have succeeded in integrating all of the functions required for a reliable diagnosis in one small standard module.

Trouble-Shooting – Easy to do

During commissioning, the corresponding software, the diagnostic manager, provides for a correct installation, if the design of the fieldbus has been optimized. An occurring problem, its cause and location can be easily identified and a solution is quickly found. Moreover, the program minimizes the repetition of tasks, thus resulting in huge time savings, with significant reductions in start-up time and the added benefit of reduced costs.

Through continuous online monitoring during operation the module informs the plant operator about the current physical conditions of the physical layer and of the supply unit and warns against possible faults. In the case of a fault, the module supplies clear information facilitating decision-making and analyzes the problem. Decisions can then be made as to whether immediate action is required, or whether the problem can wait until the next change of shift or until the next scheduled plant shut-down.

The maintenance crew has direct access to all diagnostic information of the module and therefore, quick trouble-shooting is possible. Is the terminator still in existence or are the clamps corroded? These are two causes which can be clearly excluded in a visual inspection of the plant. If the fault, however, is due to a defective field device or a bad shield, this can only be detected with an oscilloscope on the basis of the form of the signal. Pepperl+Fuchs offer special 1-day or 2-day training courses for the correct handling of the integrated measuring devices.



The Jitter makes the Difference

The ADM measures voltage, current, jitter, noise and symmetry of the connected segments and it automatically determines, e. g., the min. or max. signal levels for the system and for each individual field device. The corresponding software will generate a warning if a calculated or defined warning threshold is exceeded. Pressing a button generates a complete protocol. By this means, it is possible to prove and document all parameters relevant for a fieldbus in a time-saving manner without expenditure.

It was a long and meticulous work for the developers at Pepperl+Fuchs to design the complex measurement circuits for jitter. The tool of the Mannheim company is currently the only diagnostic module which is able to determine this decisive parameter for the quality of a fieldbus signal. The jitter is so important because an excessive deviation from the ideal value might finally result in the loss of a bit. The consequence would be as follows: The validation mechanism of the fieldbus telegram reacts and rejects the complete telegram. As a result, there are repetitions with negative impacts on the control circuits. The worst-case scenario would be a complete communication failure and shut-down of the system. The diagnostic module by Pepperl+Fuchs avoids such a situation, thanks to timely warnings. The ADM minimizes unscheduled plant shut-downs, it increases the availability and it reduces the operational expenditures of the systems. The use of diagnostic modules pays off quickly – only one unscheduled shut-down saved during the life-cycle of a plant is enough to amortize the investment.

Scheduled Shut Down

The integrated history function, which records and saves all measured min. and max. values within a defined unit of time, makes it possible to observe the measured parameters over an extended period of time. Subsequently, the values can be represented graphically in a trend function and monitored. On the basis of this information, it is possible to interpolate when a deviation could result in a problem, exactly as it is the case for the field device. If, for example, within a period of 2 years the min. signal level of a field device is reduced from 500 mV to 400 mV due to a creeping change a projection can be made that this value will reduce to 300 within further 2 years, and still 2 years later, the value probably will violate the specification. This means that a real problem will occur after four years. There is enough time left to inspect the device more in detail during the next scheduled plant shut-down.

Another advantage of the tool by Pepperl+Fuchs: For the transmission of diagnostic data it does not use the fieldbus itself. A separate diagnostic bus is used for this purpose. First, the higher transmission rates ensure a quicker transmission of data, e. g.: of the oscillograms. Second, a reliable communication is guaranteed in the event of a serious problem or during trouble-shooting. In the near future, Pepperl+Fuchs intend to make the diagnostic information available for PROFIBUS PA via the segment coupler directly on PROFIBUS DP. This would also save the separate wiring for the diagnostic bus.

A profitable Investment

The response at last year's Interkama on the ADM was tremendous. Pilot customers in Germany, Great Britain, and Australia are already operating the diagnostic module. For an Australian project, the tool actually tipped the scale. A British customer has been extremely satisfied. During commissioning, with the help of the module, he could localize a software incompatibility between a field device and the process control system. This enabled him to eliminate the fault at an early stage and to save lots of time and money. The investment in the Advanced Diagnostic Modules by Pepperl+Fuchs will pay off for the users thanks to an accelerated commissioning and a considerable increase in availability.

Dr. Christine Eckert
Journalist, Communication
for science and technology



Accelerated Commissioning

Diagnostic module facilitates handling fieldbus and generates new service offerings

The Advanced Diagnostic Module by Pepperl+Fuchs accelerates the commissioning of fieldbus systems, faults are detected earlier, and the system availability is increased due to predictive maintenance. Automatically generated documentation creates a clear situation for the handing-over of the system – both for the commissioning company and for the customer. The fields of application of the supplier-independent, mobile version of the efficient diagnostic tool might inspire many a service provider to offer various services which up until now, were absolutely unfeasible.

A good installation is the best basis of reliable digital communication. This is the conclusion of the Reinhard & Mahla test laboratory during the current examinations on trouble-shooting at the physical layer of fieldbus systems. Therefore, it is important that existing faults are detected during the commissioning but, how can you ensure this and how can you guarantee the best possible design of the physical layer of a fieldbus of the individual segments? For this purpose, the use of state-of-the-art diagnostic tools as offered by Pepperl+Fuchs are recommended. The Advanced Diagnostic Module (ADM) toolsuite examines the physical layer of the fieldbus during the installation and warns against faults before a device fails during operation.

The Advanced Diagnostic Module by Pepperl+Fuchs combines all functions for fast and efficient detection of usual causes of faults. The module does not only detect interfering signal levels but also insufficient signal levels, wrong device polarity or grounding faults. Wrong wiring, short circuit or excessive resistance do not pose any problems for this clever tool. The commissioning personnel are immediately informed by a corresponding indication should any difficulties occur during the commissioning. In this way, the faults can be restricted with the software, and the problem can be eliminated.

Following the definition of tags, the Advanced Diagnostic Module will display an overview with practical information on voltage, symmetry, noise, jitter and min. or max. signal levels of the respective segment. Subsequently, the software calculates individual warning values for each single field device and is designed such that continuous operation of the seg-

ment will always be ensured. After the measurement, a complete protocol including all min./max. values will be generated automatically - for the system and for each connected field device. In this way, fieldbus signals can be completely evidenced and documented.

Transparency Par Excellence

The documentation creates a transparent situation for the handing-over, both for the commissioning party, i. e. contractor, system integrator, technical service provider or the manufacturer of the process control system, and for the end user. Problems occurring later can be easily compared with the result during the handing-over, and a reasonable cause analysis can be carried out. For service providers, this reduces warranty costs and consequential damages. Commissioning costs are reduced by the higher degree of automation because measurement values do not have to be recorded manually anymore which used to be a time-consuming process.

Moreover, with the ADM, the actual power reserve of each fieldbus segment can be precisely determined during commissioning. From this, you can deduct the user's margin left within the specification. For every field device and segment, the actual load and the signal strength can be measured directly at the clamps of the power supply.

Experience has shown that every process plant will be retrofitted many times during its life cycle, or will be expanded by some measuring points and as a matter of course, the operating company will carry out maintenance work at times. Every modification can have a lasting effect on the physical layer of the fieldbus and so the module turns out to be very useful. The diagnostic module now allows the measurement of the current operating states in regular intervals. The software detects deviations which in the long term could result in a fault, it automatically transmits a warning message and renders proactive trouble-shooting support.

The Jitter as Quality Factor no. 1

In principle, three parameters – jitter, signal level, and noise – can be used as quality factors for fieldbus networks because their limit values are clearly defined in the fieldbus standard IEC 61158-2. However, the examinations carried out by the Reinhard&Mahla test laboratory showed that the jitter is particularly suited for



monitoring of the physical layer of the fieldbus. The jitter measurement is extremely complex, and the developers at Pepperl+Fuchs have mastered this challenge.

The edge of an ideal fieldbus signal describing the logic state of a bit theoretically comes exactly in the middle of the bit time. The point in time at which the signal edge passes the supply voltage level is called zero crossing. In practice, the existing inductances and capacitances of the connected devices and of the power supply system, the cables and the connection system influence the signal. Moreover, the topology, i. e. cable length and number and distribution of the field devices plays a role. Therefore, it is inevitable that the zero crossing in real systems varies and this is called jitter. Important fact is: If its values becomes excessive, the signal edge will leave the measuring window in which the receiver measures the polarity of the edge, and a bit will get lost. Algorithms ensuring data transmission will detect this fact and will reject the telegram as defective. There will be repetitions, if required, and the complete communication process may even stop. The process control system will record occurring telegram repetitions, but it is not able to check the signal quality of the individual parameters.

The diagnosis of the physical layer and the ability to measure jitter enables clear attribution to possible causes of faults, such as a creeping change in the capacitance of the terminators or corroded clamps. Some problems require the user to carry out a more profound examination of the problem. In some cases, only the integrated oscilloscope may be able to give information on a defective field device.

Diagnosis opens up a new Range of Service Offerings

For the specific requirements of different target groups, Pepperl+Fuchs offers the Advanced Diagnostic Module in two designs. There is a stationary and a mobile version. The stationary version is intended for users who wish to control the physical layer of their fieldbus segments. It plugs into a free slot of the power supply system and it is able to monitor up to four segments simultaneously:

- It is used to verify the physical layer of the fieldbus during commissioning
- With warnings and alarms, it informs about abnormal changes of the physical layer – incl. creeping changes

- It can be used for troubleshooting in case of complex faults
- It also allows external access, e. g. via Internet

If a Pepperl+Fuchs power supply system isn't used, at least the mobile version of the ADM can be used. With the exception of some points, it has the same functionality as the stationary module.

At any rate, diagnostic modules open up completely new service concepts. For example, in future a service provider could offer his customers the option to carry out a complete measurement of the physical layer of the plants. Inspections in regular intervals could minimize unscheduled plant shut-down. The report on the state of the fieldbus systems in regular intervals creates confidence in the technology. Service 24/7 for acute problems is imaginable. A remote maintenance via Internet for users who decided in favour of continuous online diagnosis of the physical layer could extremely facilitate the repair work – a service which also could be offered on a worldwide basis.

The ADM by Pepperl+Fuchs:

- 1. Saves plenty of time during commissioning**
- 2. Creates a quick remedy in case of problems**
- 3. Minimizes cost-intensive, unscheduled plant shut-down periods**
- 4. Considerably increases the system availability**

For service providers, it is possible to accelerate the commissioning and to hand over the system on schedule. Moreover, with the mobile diagnostic tools companies could offer many new after-sales services including maintenance and repair and open up an additional market potential for themselves.

Dr. Christine Eckert
Journalist, Communication
for science and technology



Dr. Thomas Hauff

Group Leader, Automation Center, BASF



Since up to 20 field devices are connected in a single fieldbus network, a failure frequently involves a number of components. When diagnosing the physical layer, it should be appreciated, that up to now the options available for physical layer diagnosis comprised mainly the measurement of current

and voltage and measurement using an oscilloscope. The interpretation of these “classic” methods demanded a degree of expert knowledge and was relatively expensive.

The new diagnostic modules simplify the diagnosis and at the same time provide better diagnostic information.

The principal advantages of the stationary diagnostic modules are: 1. Reduction of the commissioning time for fieldbus segments and 2. Diagnosis of the fieldbus during operation. This means that the user purchases the diagnostic modules and no longer needs to make separate measurements during commissioning, e.g. with an oscilloscope. Commissioning can take place just with the diagnostic modules, which reduces the expense of commissioning to simply operating the respective diagnostic module. Commissioning can therefore be undertaken by ordinary commissioning personnel and the use of separate fieldbus specialists is no longer required. Through these advantages during commissioning the operator wins on going benefits, i.e. the diagnosis of the fieldbus during actual operation at reduced costs, since the diagnostic modules have already amortized a part of the investment.

Oliver Weigel

Member of the automation center and European contact on the theme of the Fieldbus in the technical community at BASF and member of the NAMUR Working Group 2.6 – Fieldbus



As shown in current investigations, the effects of ageing on the fieldbus are less than was originally presumed and therefore diagnosis of the effects of ageing during actual operation is not the main area of application of the new diagnostic modules. The main use is the simple checkout of the system,

particularly during frequent operation and modification on the fieldbus. Another advantage is that in the event of an acute fault on the fieldbus, the information provided by the diagnostic module enables maintenance personnel to start the repair sooner, equipped with more fault analysis data. These advantages should significantly reduce the time taken on the repair.

The diagnostic modules are, in any case, of interest on all plants where high availability and/or continuous operation are involved, because as a rule in these plants the costs of downtime are very high. On batch plants, faults can often be eliminated at the end of a production run. And batch plants are frequently modified; therefore the diagnostic modules can even contribute to a reduction in downtime when there are major changes to the fieldbus. In principle, the decisive factors for the use of the diagnostic modules for the physical layer are always the class of plant and the level of availability required from it.

In integrating the diagnostic modules into the process control system it is important that the elementary requirements of NE 105, with reference to device integration and the requirements regarding presentation in NE 107 are taken into account. It is desirable for the future, that the diagnostic functionality becomes an automatic component of the system and that it will no longer be necessary to purchase it as an add on.

Wilfried Schmieder

Engineering Additives - Frankfurt Chemesty, Sanofi-Aventis



The investigations in the test laboratory at Rheinhold & Mahla showed, that the fieldbus quickly settled down. But there are, for example, problems that had not been revealed until the diagnosis of the physical layer.

Interestingly, the investigation has shown, that the data telegrams of different device

manufacturers do not appear as they should. At present we must accept the errors but react appropriately in new projects. From the point of view of the operator the transfer on the bus runs satisfactorily stable, in particular since its design is specifically targeted at the avoidance of the infringement of physically possible limits. Apart from the devices, up to now faults have essentially arisen only from the initial installation or from modifications. The fault quota from the installation is, in parts 10% and in some cases higher. Due to the stability of PA communication and the usual frequent changes to our plant, for the present we are making once only checks with priority being given to the physical layer, through the thorough application of mobile diagnostic modules. Even if an ageing effect should occur, it would be a long time before the system behaves out of specification, and this would certainly be detected at an early stage during plant modifications. In any case, permanent monitoring will be incorporated on the latest generation of power supplies. In particular, we do not want to perform additional time and cost-intensive checks. On installation, every device must itself detect whether the communication of this frame is OK and then output an OK or signal a fault. Users do not need cyclic protocols, which are continuously telling us that all is well. On the fieldbus, self-monitoring or function checking should be a matter of course – up to now a real deficiency. From the point of view of the user there was no long-term path to an integrated basic functionality – without additional cost. Then the Advanced Diagnostic Modules from Pepperl+Fuchs delivered to its customer's real added value!

Michael Klein

Administrator Automation at Sanofi-Aventis



As a practioner, who is around the plant every day, I regard the cyclic monitoring of the physical layer as extremely sensible.

Parts of out plant are operating in very aggressive atmospheres. Screwed connections are never 100% tight and corrosion is likely either short term or long term. Therefore I would not run

the risk of merely carrying out regular routine checks. But neither time nor money allows us to be constantly checking critical components. I would like to know whether the bus or a network deteriorates over a period of time. We have not experienced any major failures over 2-3 years, but what about over 10 years? Ageing of the bus is not normally noticeable. Any changes in the measured values would become apparent in the case of permanent monitoring. At the moment we can only take an instantaneous snapshot with the mobile diagnostic module. In order to detect a trend, many snapshots would have to be taken over the year or the plant monitored continuously. Above all, the maintenance personnel would then aware of when they must respond. At present, alarm signals relate simply to the standard program of a device. Up to now there have been none at all on the fieldbus. It is a pity that this functionality was not available in previous generations of equipment. But Pepperl+Fuchs have done wonders in providing these extensive diagnostic functions in such a small module: Hats off!



Dr. Niels Kiupel

responsible for control and instrumentation at the Degussa coatings & colorants plant at Herne/Witten



The diagnosis of the physical layer is of essential significance to us, since it presents the sole possibility of searching for errors on the fieldbus.

Conventional analyses by means of current and voltage measurements are no longer helpful here. If the fieldbus is functioning we don't have a problem,

but if it fails, we then have to adopt a "trial and error" approach. With the Fieldbus diagnostics we at last have a tool with which we can analyze the bus and isolate possible causes or contributory causes of the fault. Without this tool that is either not possible or only possible to a limited extent. Such a tool should be integrated via a simple and defined interface and should scan the bus segment automatically. It is also important that a scope function is available, which permits a graphical analysis to be obtained – similar to that of an oscilloscope. And it is also desirable to have a "task manager", so that a repeated automatic check-out can be made to detect change processes on a time basis. Since the analysis is made by maintenance personnel and not by fieldbus developers, the operation of these aids should be as simple as possible and the software should provide clear indications of the possible sources of faults. The diagnostic modules that were brought onto the market last year satisfy all known requirements. Therefore we will employ physical layer diagnosis in the future on all new fieldbus systems and when adding plant extensions and indeed we already have such a module in use. Additional costs that arise are not problematic, so long as these are of the order of those involved in instrumentation for the conventional technology. It is only when the costs are seen to be on a higher level that this is regarded as a real disadvantage, because the simple truth is, that every system should have its own means of fault analysis.

Michael Pelz

EMR Operations Engineer in the Pigments & Additives Division of Clariant Products (D) and Chairman of NAMUR Working Group 2.6 – Fieldbus



Our plants are subject to continuous change. We extend and improve them and expose them to diverse environmental effects. So the fieldbus is relatively highly loaded – perhaps even at risk. The test laboratory of Reinhold&Mahla has now investigated the stability of the physical layer with the use of

modern diagnostic tools. The results are extremely positive. We already have the Advanced Diagnostic Module from Pepperl+Fuchs in use in the ruby plant at Clariant in the Höchst industrial park for test purposes. Although the plant has been extended many times, it has operated for over one year in a perfectly stable condition. Despite this we have found initial faults (e.g. installation faults) with the help of the module. Now the bus is "clean" and a high availability and safety is guaranteed – a comforting feeling! Naturally, the additional costs of such diagnostic tools must remain within context, but the user gains fast and centralized data access through the on-line monitoring. With a handheld device you have to go on site at specified intervals of time, take measurements, store the data and then evaluate it. If the costs of personnel involvement are compared with the investment costs, it quickly becomes clear that a fixed module for permanent monitoring makes sense. In my view it pays to install a fixed tool. Then I don't have to think about when I must make the next measurement. And not least, of course, because a condition-oriented repair becomes possible by this means. From our experience I can only recommend the tools for the diagnosis of the physical layer. Clariant is planning a plant extension with fieldbus technology in the Höchst industrial plant, in which diagnosis will be employed right from the start.

Sven Seintsch

Test Laboratory BIS Process Technology in the Höchst Industrial Park, Working Group Leader, Fieldbus of the IGR (Community of interests – Control Systems Technology)



The fieldbus systems now operating have shown that the fieldbus is a much more stable communication medium than many have believed. And now, with the introduction of the Physical Layer (PL) Diagnosis, installation errors and very gradual changes can be detected, which could lead to a fault in the long term. In

addition, the diagnostic modules can now determine the reserve at which fault-free operation of the electrical system is still possible. In our investigations we have found another, perhaps unanticipated ancillary effect: The diagnosis of the fieldbus clearly reveals the weaknesses of many field devices. This leads to the situation, in which the manufacturers will have to improve their field devices. We have the relatively high fault tolerance and robust nature of the physical layer to thank, that devices operating on the edge of the PL specification have thus far caused no communication problems. Such components will in future be immediately detected during the diagnosis of the fieldbus. Thus the user will be able to select and use the best and most stable communication devices.

Another aspect for which a particularly stable PL is required is that of the use of fieldbus systems for safety tasks. The safety-aligned fieldbus protocols make use of the same infrastructure as the conventional field devices.

This leads to a particularly stable PL, since it is only in this way that the demanding requirements for bit error rates on these systems are achieved and the availability of the plant is secured. Permanent monitoring by stationary diagnostic modules is particularly suited to this task.

Dr. Thomas Tauchnitz

Manager EMR Planning for Frankfurt Injectables with Sanofi-Aventis



The physical layer is the telephone wire over which the data flows. And if this is not functioning, I certainly don't want to have to start thinking about other applications. The diagnosis is necessary in order to be certain, that the physical layer of the system is functioning, and not just more or less function-

ing, but reliably and sustainably. We have tested our existing fieldbus system using the advanced diagnostic module from Pepperl+Fuchs and found several errors in the physical layer. Despite this the bus is running. The errors were not functionally restrictive, but could have become a problem at a later stage if, for example, yet more stations had been added to the bus. It was therefore important and correct to have the system thoroughly checked out in the Reinhold&Mahla test laboratory and the faults eliminated. In my opinion it is adequate to check out systems with the diagnostic module after major expansions and revisions have been made. I don't think it is necessary to have the module running continuously. However, this does also depend on how far the system is from its limits. So long as the bus is operated well within its physical limits we can live with a certain amount of deterioration. For example, the physical characteristics of the cables deteriorate to some extent with time, but not in an extreme manner and certainly not overnight. And at present our system is far away from any such restrictions. If the system is running at the limit of the bus physical layer, for example due to long lengths of cable and the number of devices, then a small deterioration can have a dramatic impact – and it would then make sense to apply permanent diagnosis. Indeed: The costs of a checkout with the diagnostic modules are low in comparison to unplanned system downtime.



The Fieldbus, the unknown entity?

Interview with Juergen George, Pepperl+Fuchs

Published in MessTec Automation, Edition 11/2006 and CHEManager 2/2007

How reliable, or in other words, how good is the actual availability of the fieldbus? In between all the discussions in recent years the user has meantime often become uncertain – because along with the uses of fieldbus technology there are automatically questions relating to its behavior with age. At the Annual General Meeting of Namur this year, Herr Pelz, Chairman of the NAMUR Working Group “Fieldbus” presented a study relating to the chemical and pharmaceutical industry, which was conducted by Herr Seintsch of Rheinhold & Mahla Prüflabor (Test laboratory). The fieldbus is reliable! And with fieldbus diagnostics it is becoming even more reliable and easier to comprehend and to operate.

Why does the world of processing need a fieldbus diagnostic tool?

J. George: On the one hand for the commissioning of the fieldbus systems: The planners and commissioning engineers required a fieldbus expert at their side, at least up to the point at which the system is running free of faults. With a good diagnostic module it is possible to see just which items are running correctly and which require further attention. Corrections can then be undertaken in a targeted way. The whole process of commissioning is simplified.

The second argument in favor of a diagnostic tool relates to the overall life cycle of the installed fieldbus system. The investigations mentioned above have shown, that the fieldbus, when it initially has started to operate, is very stable and available – “reliable”, but under certain circumstances with minimal operating reserves. The system sometimes can handle three terminators instead of two, and it runs. But then suppose, for example in an aggressive atmosphere, terminal corrosion sets in or EMC problems arise due to problems with cable installation or the screening concept ... then the whole segment may fail in an unpredictable and abrupt way. Imagine the situation in which an extension has been planned from the start – additional devices shall be coupled to the bus in future. Even with such unidentified problems the segment is running reliably. However, the additional devices are then added and the bus fails. With the diagnostic tool the operator will know about the quality of the data transfer and will be warned in good time of the impending



risk. The cost of a good diagnostic tool is certainly small when compared with the benefits – for example the avoidance of unplanned plant downtime.

How has the diagnosis of a fieldbus system previously taken place?

J. George: It was always quite clear that you don't get very far just armed with an ohmmeter. Trained specialists have to be employed. In simple cases handhelds could be used, but in more complicated and difficult to explain phenomena bus monitors and/or oscilloscopes become indispensable. And these have to be handled by experts. In other words: A large number of measurements and measuring instruments are required, which even in combination were not able to present a complete image of the state of the fieldbus physics.

What does your tool in detail and how does it differ from comparable systems on the market?

J. George: The Advanced Diagnostic Module is a plugin module for the FieldConnex® Power Hub. It monitors the fieldbus physics online and in real time. It continuously measures all the parameters that are of relevance to the fieldbus and each field device. The trip values for all warnings and alarms are stored in the module and so it is now possible to obtain information on changes in the signal quality in the control system. The plant operator normally receives information in advance before a field device goes out of business. That really is a first!

The module saves history for up to two years. So long term effects, possibly due to ageing, can be traced and analyzed. In addition, the data can be very conveniently exported as a text file or directly to Excel. The soft-

ware (Diagnostic Manager) contains additional functions, which essentially ease the operation of the fieldbus: For example, there is a Commissioning Wizard. This guides the user through simple menus of the type recognizable from typical Windows presentations and enables many operations to be executed in just a few minutes: The complete validation of the fieldbus segment and the connected field devices; the setting of the trip values for all relevant alarm parameters required for operation; the automatic configuration of the diagnostic bus and all connected modules. All fieldbus segments are conveniently and efficiently operated from a workstation. And, of course, the associated documentation is available in both printed and electronic formats.

Which typical faults can be detected with your system?

J. George: It starts with simple items, such as an incorrect termination or a short-circuit between a signal cable and the screen, but goes on to cover more difficult to locate faults such as noise and excessive jitter caused by individual fieldbus components, the transient characteristics of individual stations and incompatibilities between individual components. In practice it has been found that only 2 in 100 segments actually need to be corrected during commissioning.

But, lets make it quite clear! The fieldbus is “reliable” and the diagnostic tool is not required just to detect any faults that may occur. It has very much more to do with detecting long-term changes in the physical layer parameters and visualizing them at a point in time when they have not actually become a problem. The aim is to provide information on changes while the parameters are still within the permissible range. The key phrase here is preventive maintenance to make the fieldbus even more reliable and therefore even more available.

You said at the start, that the files are displayed on a maintenance computer. How does that work? Does it mean additional cabling? Is an additional bus required for the transfer of the diagnostic data?

J. George: You can imagine, that with such a large number of measurements a considerable volume of data accrues, particularly if the integrated oscilloscope is used. With this volume of data we do not want to cause additional load on the control communication and yet we want to display the data as soon as possible. A simple two wire bus in the cabinet with an

RS485 interface is used to interconnect the diagnostic modules. Using a simple converter, which we can also supply, this signal can be transformed to the Ethernet. So you can see: We use here very robust and proven and tested technology, which is also cost-effective.

It may also be the case that you do not want to directly use the medium you have just diagnosed for data transfer. We offer a transparent coupler for Profibus DP and PA. And we can now make a distinction here: Profibus PA is monitored by the Advanced Diagnostic Module. We are currently working on a solution, with which the diagnostic data for the physics of the PA bus are transferred via a so-called tunneling via DP. This is possible because it involves two separate cables.

Are the diagnostic data evaluated directly in the control system or is additional software required?

J. George: The plant operator does indeed have some understanding of the fieldbus, but in day-to-day operation it is not of great interest to him. The diagnostic module provides OPC data via an open interface. OPC has become established as a standard in the world of control technology for the transfer of data between different systems. These group signals are integrated in the control system. The plant operator merely receives the warning that the fieldbus needs to be checked.

With this information the maintenance personnel can then scrutinize the information in detail at their workstation to see which trip value violations have led to the warning. It is particularly important that the service personnel now make appropriate decisions and plan the appropriate course of action to be taken while the plant is still running satisfactorily. In most cases with the appropriate knowledge about the state of the communication it should be possible to take the appropriate action at the next planned servicing, re-equipping or plant modification. You see: The fieldbus tolerates almost any fault, even e.g. a single-sided short-circuit. The important thing is that this initial fault is detected and can be eliminated before a further fault arises. So the fieldbus is not only reliable in the way it functions, but is also easy to comprehend and manage by commissioning engineers, plant operators and maintenance personnel. So everyone benefits!



Dr. Gunther Kegel

Member of the Fieldbus Foundation Board of Directors



If we take a closer look now at the maintenance and repair structures – for example in the chemical industry – it becomes clear, that one technician has the task of looking after between 500 and 1000 instrument circuits, or so-called loops. With around 1000 available working hours in the year, he is able to devote between

one and 2 hours on average to each circuit – adequate to maintain the plant in a safe operating condition.

We have heard at the last main assembly of NAMUR, that in the future one technician will have to attend to the maintenance of maybe up to 2000 loops and looking even further ahead, even up to 4000 loops. With the targeted 4000 measuring stations per man it will at the least have to be possible to exclude problems with the physical layer from the start.

This is where “Fieldbus Advanced Diagnostics” come into play. Only by this means is it possible to ensure – effectively at the touch of a button – that at least on the level of the Fieldbus topology and wiring, no faults have occurred.

In the future there may be an even more intensive pressure on maintenance, with ever fewer personnel. This is the clear intention, not just on the basis of costs, but also for quality and safety reasons. Plants are always unsafe when they are operated outside their intended envelope, as for example may occur during repair measures. It is at this time that the plant reaches its highest possible state of unreliability. It is also for this reason that the aim must be to significantly reduce the number of unplanned maintenance and repair procedures and to avoid – whenever possible – dangerous conditions when parts of the plant are run under abnormal conditions. Intelligent tools like the “Fieldbus Physical Layer Advanced Diagnostics” can help to detect threatening error functions in such good time, that the necessary remedial work can take place during an already planned plant stoppage. It is in this way that modern diagnostic tools make a contribution to plant safety and the cost efficiency of repair and maintenance.

Dr.-Ing. Gunther Kegel is CEO of Pepperl+Fuchs GmbH and chairman of the European Executive Advisory Council of the Fieldbus Foundation.

Jörg Schneider

Chairman of Working Group Sales & Marketing of PACTware Consortium e.V.



On around one third of all plants the operators now employ fieldbus technology – whether on pilot plants or full-scale projects. Pepperl+Fuchs is involved in over 50% of these plants. The latest major international order was the new refinery by Reliance, the first large fieldbus system in India, with 50,000 fieldbus

devices – an enormous project and a real challenge – because the technicians are still not in a position to properly install the physical layer. If the quality of the plant installation is not verified before commissioning, it will be our worst nightmare. The plant is so widely spread out, that it will simply be impossible to avoid faults without intelligent means such as the Advanced Diagnostics Module. The personnel involved have little experience and in addition must work under extreme ambient conditions, because the plant lies directly on the water, where they must cope with salt and sulphate mist, as one can imagine. The operating conditions are extreme and the equipment ages quickly. Cables and dampness under such conditions become a problem far earlier than in a factory under central European conditions. The following certainly applies here: If a fieldbus system is to emerge from the installation phase without faults, very careful and attentive working is required. In the longer term and with improved practice many physical layer problems will disappear. However, at this point in time, without the extended diagnosis, the users do not know how to set about the search for faults.

Jörg Schneider is Regional Sales Director Germany of Pepperl+Fuchs GmbH



Methods for Planning, Installation, Commissioning and Diagnosis of Fieldbus Installations

Andreas Hennecke
Pepperl+Fuchs GmbH
Königsberger Allee 87
68307 Mannheim
Germany

Sven Seintsch
R&M Industrieservice Höchst GmbH
Industriepark Höchst, D 710
65926 Frankfurt am Main
Germany

Thomas Kasten
Pepperl+Fuchs GmbH
Königsberger Allee 87
68307 Mannheim
Germany

Abstract - The break-through and acceptance of serial digital communication in the process industry was caused by providing high power to the fieldbus trunk. Serial communication between as many as 32 devices on one segment offers many advantages. The de-facto fieldbus standards for both PROFIBUS PA (PA) and FOUNDATION Fieldbus H1 (FF) are based on IEC 61158-2. The experiences of the first fully operational major production plants in the chemical and pharmaceutical industry show that plant-wiring concepts, shielding, training and the right tools are essential to gain the benefits of fieldbus technology. This paper describes working practice for all phases of the project: planning, commissioning, plant start-up, operation and online troubleshooting of fieldbus systems. Strategies are described that enable users to maximize the benefits of fieldbus technology.

Index Terms — Fieldbus, diagnosis, FOUNDATION Fieldbus, PROFIBUS PA, MBP, installation, commissioning, start-up, troubleshooting, High-Power Trunk, Ex-protection

I. Introduction

Fieldbus installations are replacing conventional technology not only in greenfield applications. New users to fieldbus technology often consider using it for smaller system modifications, plant expansions or simply as a field test. The FuRIOS study [1] verified the technical and commercial viability and many plants are in operation. Working with fieldbus inspired manufacturers to provide equipment for checking and testing fieldbus installations.

This paper briefly reviews fieldbus topologies that have been discussed in various publications and summarizes experiences gained in all parts of the process plant's life cycle. Necessary terminology describing the physical layer is introduced and various tools for fieldbus work are described. The paper concludes with troubleshooting examples that illustrate the fact that fieldbus is indeed a stable and useful tool for application in process plants.

II. Fieldbus Topologies

Fieldbus installations utilizing one of the two leading communications protocols, namely FOUNDATION Fieldbus and PROFIBUS PA are widely accepted in applications requiring Ex-protection. The fieldbus connects field devices such as sensing equipment and actuators with each other as well as with higher-level control systems. Both the communication signal and electrical energy powering the field devices are transmitted via the same shielded, twisted-pair cable as described in IEC 61158-2.

Though this standard describes various topologies,

current installations give preference to a trunk-and-spur topology as shown in Figure 1: Trunk-and-spur fieldbus topology. The majority of users prefer connection of only one device per spur for clean system design and simplified work in the field.

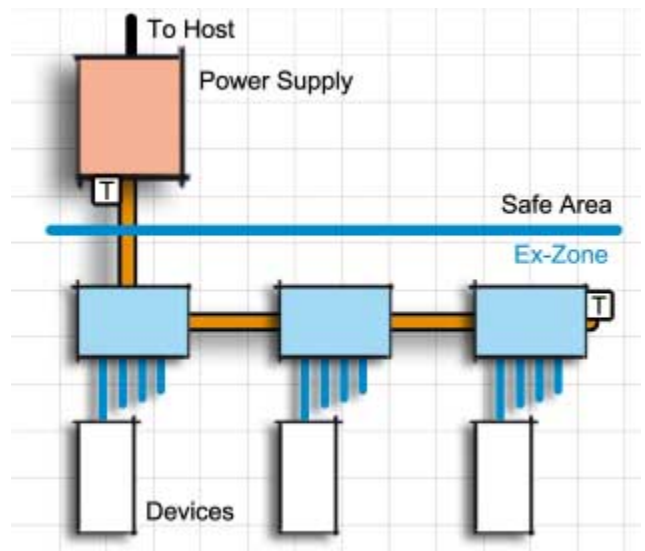

Figure 1: Trunk-and-spur fieldbus topology

A. Certification for Ex-Applications

Various concepts are known for simple validation of appropriate Ex-protection. FISCO [2] and Entity are the most popular in use today and described in more detail in IEC-standards IEC 60079-27 and IEC 60079-11. Cable length and number of devices connected are limited in order to achieve Ex-protection.

The high-powered trunk expands on FISCO and Entity: Unlimited energy of up to 31 V and 500 mA or more powers the trunk, which then requires protected wiring method. At the same time, active fieldbus installation technology such as segment protectors or fieldbus barriers provides non-incendive or intrinsically safe connection of spurs to the trunk.

This energy limited topology allows for hot working on the spur and the field device without requiring access to the trunk. This technology enables maximum cable lengths and the highest number of connected devices at the same time. Additionally, each segment is protected from short-circuit conditions on any spur.

Ex-protection is certified utilizing FISCO or Entity for each spur with the active component acting as power supply and the field device as power drain. Details pertaining to high power on the trunk are described in [3].

B. Advantages of Fieldbus

Fieldbus installations benefit from integration of field device data into the control system, leading to reduced capital and operations expenditures:

- Increased accuracy of measurements
- Remote configuration capabilities
- Availability of field device diagnostic data
- Reduction of many aspects of planning and installation

State of the Asset Management systems access diagnostic information of field devices. Self-supervision status of field devices is transmitted to the DCS. This includes information about device failure, out-of-spec behavior or required maintenance. Educated decisions by operations and maintenance staff increase system reliability and availability and reduce maintenance cost and number/duration of unplanned shut down.

C. Disadvantages of Fieldbus Installations

Up to 31 field devices are connected in parallel to the same fieldbus cable and utilize serial communication for transmission of data. This leads to certain disadvantages inherent to fieldbus compared to conventional technology. Users are learning to deal with these.

1. In conventional technology one cable is used per field device. Loss of communication to just one device is considered tolerable. A fault on one fieldbus segment with multiple connected devices will almost certainly cause a process upset.

2. Where a multi-meter device was sufficient to measure 4...20 mA signals, serial communication defines a new set of measurements that is not easy to detect due to the fact that data transmission signals are modulated onto the power supply.

3. Engineering, planning, installation, maintenance and project management must familiarize themselves with serial communication and its requirements.

III. Planning and Installation

Today a variety of commercial and free software tools exist enabling users to plan a working fieldbus topology. With simple drag-and-drop menus the user specifies power supplies used, cable lengths and number and type of field devices. The software determines feasibility by calculating voltage drop and current load. In a short amount of time, the fieldbus topology planning including the number of segments, cable lengths, and other items are completed.

With regards to cable installation of the trunk IEC 60079-14 states that cabling must be protected from

- Mechanical damage
- Chemical influences
- Corrosion and
- Temperature

It is the same protection as applied for installation of lighting appliances and Ex d devices. Additionally, local regulations may demand stronger requirements, which must be observed. As of this date a generally applicable international standard or guideline is not available.

Experience shows that the following aspects, if observed, generate a large payoff:

(1) Train installation personnel to gain an understanding of fieldbus technology and requirements. Wiring methods and installation material as well as field device connections will be new to most technicians;

(2) Always use cable conforming to known specifications. The most common cause for problems with fieldbus is cabling with impedance out of specification;

(3) Carefully validate installation and wiring. A particularly important factor for long-term stability of fieldbus communication is the proper use of shielding and grounding. It must be planned to achieve desired EMI-protection. Hard grounding at both ends is often used, when the plant is built in a small area such as a building block. Capacitive or one-sided grounding is implemented for process plants spread over a wide area. There is no solution that fits all applications as too many factors influence this decision. [4]

(4) Test the application before installation in the field. Novice users, in particular, will gain significant experience from laboratory testing. This point generates large savings, when experience gained can be applied immediately during installation and commissioning and many hours of troubleshooting are saved.

IV. Fieldbus Signals and Measurements

Signal and power are transmitted using the Manchester bus powered protocol (MBP). A signal current is modulated onto the power supply resulting in a transmitted signal voltage of 0.75...1.00 V p-p from the 50-ohm impedance created by the bus termination. The received signal must be greater than 0.15 V p-p. This allows for a signal loss up to a factor of 5. Rising and falling edges code logic 0 and 1.

A. Physical-layer Measurements

Signal level: Figure 2 shows a fieldbus signal level with 900 mV peak to peak. Rising and falling time is 6.4 micro sec. as measured with the vertical bars on the screen. The voltage is measured between the two leads of the twisted-pair cable. Measurement: Milli-Volts per device.

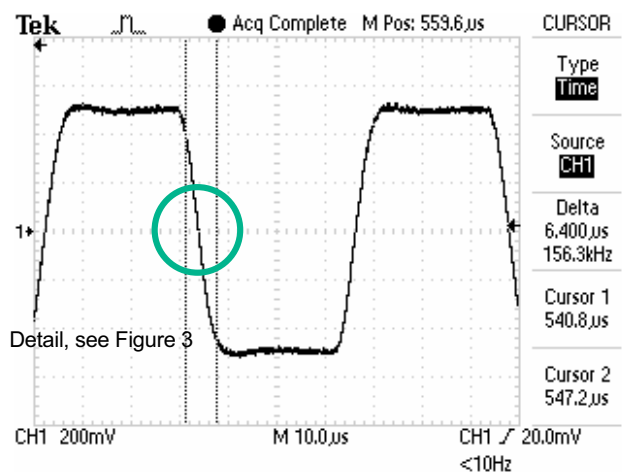

Figure 2: Near perfect signal shape

Unbalance: Where one of the leads has a resistive connection to ground the signal will be offset. This is referred to as unbalance to ground. Measurement: Percent per segment.

Noise – An undesired, random or patterned signal that is induced onto the fieldbus. It is measured as voltage.

Patterned noise typically stems from other electronic equipment such as frequency converters. Measurement: Milli-Volts per device and segment.

Jitter – The rising or falling edge of each bit is expected at regular time intervals, called bit time. During a very small time window the receiver will measure the data signal and expect the edge transmitting the bit. The deviation of the time from the expected time is called Jitter. High Jitter will cause bit errors and therefore telegrams to be lost. Most influences on fieldbus communication lead to Jitter, making it a central measurement for fieldbus diagnosis. Measurement: Milli-Second per device and segment.

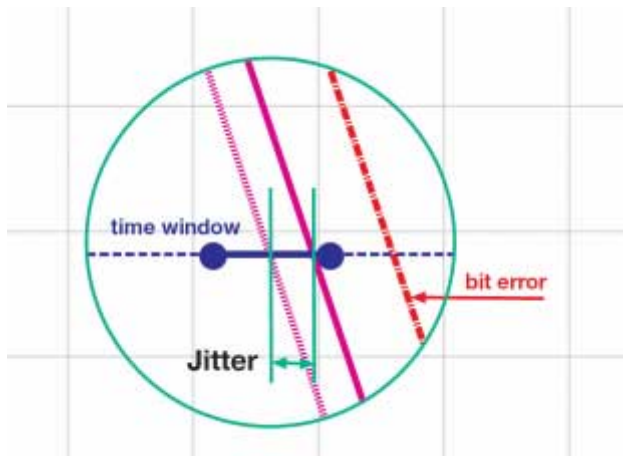

Figure 3: Jitter measured as deviation from the ideal zero crossing

B. Communication

Statistics regarding fieldbus communication are typically counters for:

- Segment live list
- CRC error counter (Cyclic Redundancy Check)
- Frame error counter (Frame = Telegram)
- Number of received frames

C. Resistance to Disturbance

Fieldbus works. Consider this somewhat fatal condition: An Unbalance of 100 % is a solid connection of one lead to ground. Power supply and data transmission will continue to function properly as both are transmitted as potential between the two leads. Only a second fault, such as the other lead connecting to ground will cause a short-circuit and communication failure. In most cases, the situation is not as trivial as in this example:

- Shorts are actually impedances that may be caused by water ingress or component aging.
- Loose wire strands reduce resistance to EMI.
- Improper bus termination causes extra load for the signal level or
- Devices are connected with the wrong polarity.

Fieldbus can be viewed as having a budget for fault tolerance. Each bullet mentioned will take some of this budget, and when more than one condition exists without detection, the communication may become unstable. This is illustrated in the examples shown later.

D. Tools for Fieldbus Diagnosis

Tools for measuring fieldbus signals are distinguished as:

Bus tester: A simple, typically hand-held device for measurement of resistance, signal level, noise and supply voltage.

Bus analyzer: It verifies field device communication. The bus analyzer is a passive device on the fieldbus. It decodes telegrams and monitors for transmit timing and telegram types. It enables the user to verify content of telegrams as well as proper request and response cycles.

Oscilloscope: The oscilloscope is used to visualize fieldbus signals. It can trigger on a telegram, but is not able to distinguish between telegrams from different addresses. Being bulky, complex to operate and requiring a hot work permit for operation in Ex-environments, they are often used as a last resort for troubleshooting.

Online diagnostic tools: Modules plugging into the power supplies. Comprehensive measurements of the physical layer as well as communications statistics. Trending and alarming functions enable supervision during normal operation. Remote access from the control room is not only convenient but time and cost saving, since analysis is conducted with complete documentation at hand and not in harsh environments. Online tools deliver detailed diagnostic information enabling users to interpret actual conditions in the field.

Many hand-held devices are certified for hazardous area use in Zone 1. Some devices will draw power from the bus. Compared to battery-driven, passive devices the disadvantage is that fieldbus physics change and measurements are not what they would be without the device connected. Typically developed for a single purpose, more than one hand-held device is necessary to perform a complete fieldbus checkout. Devices will show a value as in or out of specification thus showing that an irregular condition exists. By doing so they can create trust in fieldbus technology. It is often simple to use.

Additionally the often fully loaded networks certified to FISCO or Entity cannot cope with the extra load from the testing device. Troubleshooting always requires personnel to be in the field, and connecting a hand-held device requires proof of proper ex-protection even if it is only for temporary use. Currently, hand-held devices are available only for FOUNDATION Fieldbus.

V. Phases of the process plant life cycle

A. Commissioning and Plant Start-up

In general hand-held devices are used to check and validate fieldbus communication. Technicians can connect all field devices simultaneously and detect duplicate addressing and proper signal levels. It is important to check for proper bus termination often too many or too few bus terminators are used. Finally the fieldbus check-out should end with measuring the current under full load conditions. On the spot engineers have another cross check of planned and actual load conditions. They know the available reserve per segment for system modifications, before documentation has been updated. End-users report that up to 30 minutes less time is required per device for fieldbus validation in comparison to conventional technology.

During plant start-up online tools enable supervision and monitoring for modifications often necessary after the initial commissioning phase. Critical loops can be supervised continuously for communications stability.

B. Troubleshooting

In the absence of online monitoring tools, troubleshooting of fieldbus networks has been reactive. Typically, this work occurs when the communication to one or more devices is interrupted. Where a fault occurs techniques similar to those used during commissioning are applied to troubleshoot the network. Personnel must be in the field to assess the situation. A great value in troubleshooting is knowledge about the installation, which in combination with measured values creates often a complete picture about the situation and enables users to hone in on the trouble spot. In cases where multiple faults compound or where the signal is severely distorted oscilloscopes are used to display and analyze the actual waveform of the communications signal.

C. Normal Operation

Only online tools are able to supervise and alarm the user of abnormal conditions as described earlier. Integrated into the DCS system via open interfaces such as OPC, the user is able to include the fieldbus itself into supervision and asset management. Online diagnostic tools can work in real time and provide visibility into the health of the network and predict the availability of data at any given time. Plant operators are thereby enabled to proactively plan maintenance where required before communication fails, thus increasing plant availability.

Continuous monitoring is also desirable for plants where the following frequently occurs: reconfiguration of batch processes, small system modifications or maintenance during plant operation. All conditions may cause changes to the physical layer. Advanced online diagnostic tools are able to detect deviations from optimal conditions and alarm accordingly, this helping to solve cases, which are often difficult to stage or recreate in a laboratory environment.

VI. Examples of Fieldbus Diagnosis

This chapter shows fieldbus signals in characteristic situations of actual fieldbus installations. In most cases a DTM-style screen as shown in Figure 4: Physical Layer Data of Fieldbus is sufficient to detect signal noise or unbalance, the following diagrams show the actual signal shapes as measured by an oscilloscope for illustration purpose. The description by maintenance personnel is given followed by the causes found through diagnosis.

Power Supply Module Data							
Label	Actual	Target	Failure				
Module A	Isolated Module	Isolated Module	<input checked="" type="checkbox"/>				<input checked="" type="checkbox"/>
Module B	Isolated Module	Isolated Module	<input checked="" type="checkbox"/>				<input checked="" type="checkbox"/>

Physical Layer Data							
Label	Low Out...	Low Main...	Actual	High Mai...	High Out...	Hyst.	Reset
Voltage [V]	9.0	<input type="checkbox"/> 11.0	<input checked="" type="checkbox"/> 29.8	30.0	<input type="checkbox"/> 32.0	<input type="checkbox"/> 1.0	Reset
Current [mA]		65	<input checked="" type="checkbox"/> 78	125	<input checked="" type="checkbox"/>	30	Reset
Unbalance [%]	-84	<input checked="" type="checkbox"/> -84	<input type="checkbox"/> -40	84	<input type="checkbox"/> 84	<input checked="" type="checkbox"/> 20	Reset
Min Signal Level [mV]	200	<input checked="" type="checkbox"/> 600	<input checked="" type="checkbox"/> 705			100	Reset
Max Signal Level [mV]			819	1200	<input type="checkbox"/> 1200	<input checked="" type="checkbox"/> 100	Reset
Noise [mV]			39	100	<input type="checkbox"/> 100	<input checked="" type="checkbox"/> 25	Reset
Jitter [us]			1.1	3.2	<input type="checkbox"/> 3.2	<input checked="" type="checkbox"/> 0.8	Reset

Figure 4: Physical Layer Data of Fieldbus

A. System Unbalance

Error description: The communication was stable for a long time, but then a device disappeared for several hours from the live list. Later, the device could be seen again.

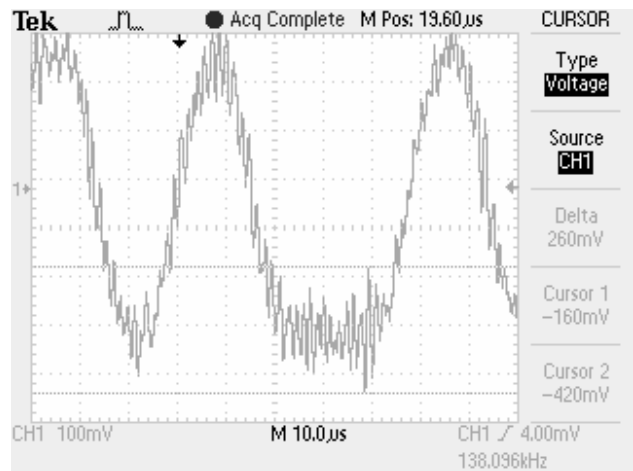

Figure 5: Signal noise and high cable capacitance

Analysis revealed: Earth potential was not wired to solid ground in the field causing an unbalance of the signal. Additionally, cable from previous installations was used. This cable did not conform to specifications since the capacitance was too high. Unbalance was measured. The significant noise level on the line, which also points to improper shielding or unbalance of one wire against ground.

B. Lack of EMC protection

Error description: The LCD's of field devices were energized but the devices were in the live list just for a short time.

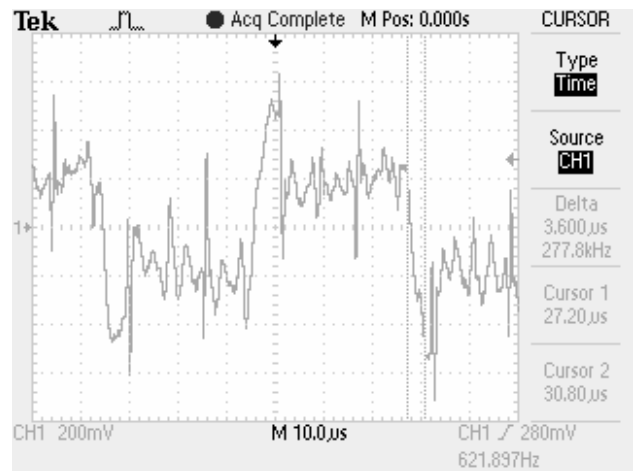

Figure 6: Lack of EMC protection

Analysis revealed: Crosstalk from a frequency converter entered through circuitry of the power supply. Again, improper cable was used. In this case the noise level and signal edges, as well as the frequency was such that many telegrams were destroyed during communication. With proper cable, slightly lower, yet significant levels of noise would not have shown at all.

C. Hardware fault at a field device

Error description: Everything was operational, but the

signal of a device was definitely asymmetric. There was no fault indication on either the handheld tools or the DCS.

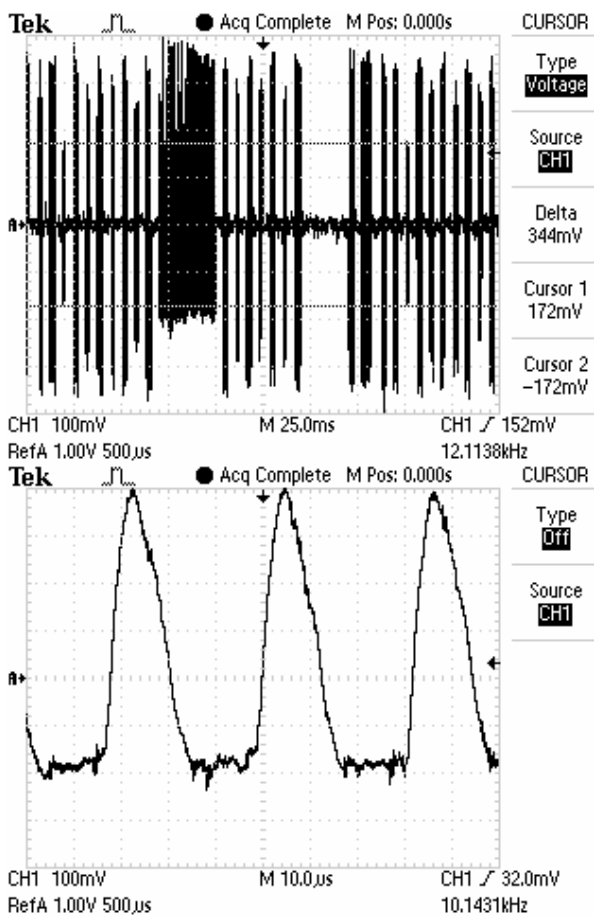

Figure 7: PCB-Diode failed in field device shown in two time scales

Communication has not failed at this point in time. A signal unbalance existed for one device only. A faulty diode cut the signal.

The examples illustrate that conditions deteriorate over time leading to temporary faults, which appear to be particularly hard to locate. Using the correct diagnostic tools reveal that they are actually multiple conditions that have compounded and exceeded the fault tolerance budget as described in Section IV.C. Resistance to Disturbance.

D. Resonance effects from a device

Error description: Significant noise was measurable. Yet the fieldbus was running stable.

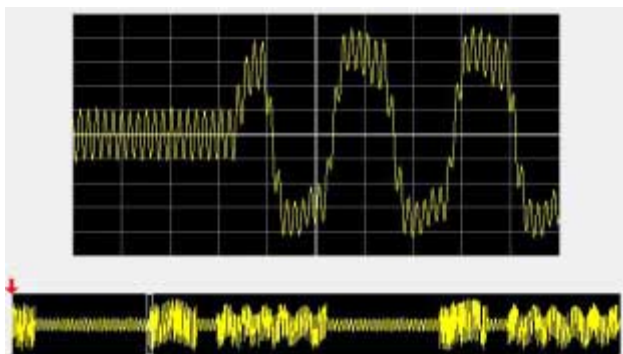

Figure 8: Noise induce by field device

Analysis revealed: A faulty device caused introduced this noise on the fieldbus. A similar device had caused the same problems in the past.

VII. Conclusions

Fieldbus topologies consistently use high-powered trunks. Fieldbus technology is described in its own terminology. Planning, measuring, validation and troubleshooting require tools that bring visibility to fieldbus communication. A new generation of measuring and diagnostic tools elevate installation and troubleshooting from trial-and-error methods to smart practice with good visibility into the health of the fieldbus network. They include the fieldbus itself into the chain of supervisory control. Process plants with very high demands for reliability will benefit from this control through its contribution to uptime and plant availability.

VIII. References

- [1] Tauchnitz, T, Schmieder, W., Seintsch, S.:FuRIOS: Feldbus und Remote I/O - ein Systemvergleich. atp - Automatisierungstechnische Praxis 44 (s00s), H. 12, S.61-70
- [2] Johannsmeyer, U: Investigations into the Intrinsic Safety of fieldbus systems, PTB-Bericht W-53e, Physikalisch-Technische Bundesanstalt, Braunschweig 1994.
- [3] Kasten, T.: *Modern Topologies of fieldbus networks* Pepperl+Fuchs, Mannheim, Germany.

IX. Vita

Andreas Hennecke graduated from the Bergische Universität Gesamthochschule Wuppertal as Dipl.-Ing. Electrical Engineering in 1991. He received an MBA from Rollins College of Winter Park, FL in 1998. After working in software development, project engineering and product marketing for SCADA systems and power distribution systems he joined Pepperl+Fuchs in 2005 and holds the position of Product Marketing Manager. He is a member of the PA marketing committee at the Profibus User Organization, PNO.

Sven Seintsch, Dipl.-Ing. is fieldbus specialist within the test laboratory of R&M Industrieservice Höchst GmbH (former Infracerv Höchst Technik GmbH & Co.KG). He has carried out fieldbus projects in chemical and pharmaceutical plants. He is an active member of the NAMUR working group 2.6 Fieldbus. He is also head of the working group Fieldbus within IGR (Interessengemeinschaft Regelwerke Technik) at the Industriepark Frankfurt-Höchst.

Thomas Kasten, Dipl.-Wirtsch.-Ing. is Marketing Communications Manager at Pepperl+Fuchs GmbH. Prior to that he held several positions outside of Germany, covering technical marketing and service. He is a member of the European Marketing Council of the Fieldbus Foundation.

ADVANCED DIAGNOSTIC MODULE FOR THE FIELDCONNEX® POWER HUB SYSTEM



Benefits

- In-depth Physical-layer Diagnostics with remote access capabilities
- Simplified segment commissioning with network documentation
- Real-time monitoring, alarming and trending detects performance degradation for pro-active maintenance
- Troubleshooting from the control room and from off-site for increased system availability

In fieldbus applications, monitoring the physical layer maximizes system availability. Fieldbus applications employ complex data communication signals that allow for up to 32 devices to communicate on a single cable. Communications can be adversely effected by such things as water ingress, loose wire strands, corrosion and line noise. Over time these factors compound and can degrade the communication signal leading to network instability. Handheld diagnostic tools do not offer a detailed look into the physical layer or real-time monitoring for system integrity.

The Advanced Diagnostics Module (ADM) for the FieldConnex® Power Hub system provides both monitoring and local data storage of physical layer for up to four fieldbus segments. This patent pending technology provides the user with easy node commissioning, real-time monitoring/alarming and remote accessibility for troubleshooting.

Commissioning is Simplified:

The Advanced Diagnostic Module measures device signal level, termination, cable continuity, and duplicate node addressing. Commissioning personnel can now perform cable checks and efficiently validate nodes. This module will also generate network documentation, all reducing start-up time and cost.

Real-time Monitoring and Trending:

A snapshot of communication taken during commissioning establishes a baseline status of each fieldbus segment. Pre-set, adjustable alarm levels are set to indicate deviations from the initial baseline conditions. The network can now be maintained from a pro-active standpoint, increasing the overall system availability and reducing maintenance cost.

Remote Access and In-depth Troubleshooting:

The Advanced Diagnostic Module allows for live monitoring from the control room or remotely by an off-site fieldbus expert. To aid in troubleshooting the ADM offers specifics on network characteristics such as crosstalk, signal jitter, resonance and can pinpoint exact node problems. A powerful integrated oscilloscope provides a detailed view on network communication and significantly enhances troubleshooting. The tool supplies everything necessary for quick diagnosis and a faster time to repair.

Technical Data and Detail

Features	
	Plug-in module for FieldConnex® Power Hub system
	Continuous long-term data storage
	Advanced Diagnostic Module supporting four segments
	FDT/DTM-based interface
	Integrated oscilloscope
	Remote access
	The Segment Monitor displays physical layer and communication data per segment and device conveniently on one screen. Each item is classified as excellent, good or out of spec with color indication. The report generator creates a measurement report thereby documenting fieldbus segment validation.
	Mobile Advanced Diagnostic Module available for single segment supervision
Selection of Physical Layer Diagnostics	
	Bulk power health
	Segment voltage and current
	Segment unbalance (signal to earth leakage)
	Segment noise
	Device communication signal level
	Signal polarity
	Signal jitter
Selection of Communication Statistics	
	Segment live list
	CRC error counter (Cyclic Redundancy Check)
	Frame error counter
	Number of received frames



MOBILE ADVANCED DIAGNOSTIC MODULE

Mobile Advanced Diagnostic Module

A mobile advanced diagnostics module with USB-port for direct connection to a laptop is available for local diagnostics and troubleshooting. Separate power leads are provided for temporary installation inside the marshalling cabinet.



PROCESS AUTOMATION – PROTECTING YOUR PROCESS



For over a half century, Pepperl+Fuchs has been continually providing new concepts for the world of process automation. Our company sets standards in quality and innovative technology. We develop, produce and distribute electronic interface modules, Human-Machine Interfaces and hazardous location protection equipment on a global scale, meeting the most demanding needs of industry. Resulting from our world-wide presence and our high flexibility in production and customer service, we are able to individually offer complete solutions – wherever and whenever you need us. We are the recognized experts in our technologies – Pepperl+Fuchs has earned a strong reputation by supplying the world's largest process industry companies with the broadest line of proven components for a diverse range of applications.

1 Worldwide/German Headquarters
Pepperl+Fuchs GmbH
Mannheim · Germany
Tel. +49 621 776 2222
E-Mail: pa-info@de.pepperl-fuchs.com

2 Asia Pacific Headquarters
Pepperl+Fuchs PTE Ltd.
Singapore
Company Registration No. 199003130E
Tel. +65 6779 9091
E-Mail: pa-info@sg.pepperl-fuchs.com

3 Western Europe & Africa Headquarters
Pepperl+Fuchs N.V.
Schoten/Antwerp · Belgium
Tel. +32 3 6442500
E-Mail: pa-info@be.pepperl-fuchs.com

4 Middle East/India Headquarters
Pepperl+Fuchs (India) Pvt. LTD
Bangalore · India
Tel. +91 80 28378030
E-Mail: pa-info@in.pepperl-fuchs.com

5 North/Central America Headquarters
Pepperl+Fuchs Inc.
Twinsburg · Ohio · USA
Tel. +1 330 486 0002
E-Mail: pa-info@us.pepperl-fuchs.com

6 Northern Europe Headquarters
Pepperl+Fuchs GB Ltd.
Oldham · England
Tel. +44 161 6336431
E-Mail: pa-info@gb.pepperl-fuchs.com

7 Southern/Eastern Europe Headquarters
Pepperl+Fuchs Elcon srl
Sulbiate · Italy
Tel. +39 039 62921
E-Mail: pa-info@it.pepperl-fuchs.com

8 Southern America Headquarters
Pepperl+Fuchs Ltda.
São Bernardo do Campo · SP · Brazil
Tel. +55 11 4339 9935
E-Mail: pa-info@br.pepperl-fuchs.com

www.pepperl-fuchs.com

 **PEPPERL+FUCHS**
PROTECTING YOUR PROCESS