



FACTORY AUTOMATION

Manual

VAG-PB-KF-R4

AS-Interface/PROFIBUS Gateway
IP20



CE

With regard to the supply of products, the current issue of the following document is applicable:
The General Terms of Delivery for Products and Services of the Electrical Industry, as published by
the Central Association of the 'Elektrotechnik und Elektroindustrie (ZVEI) e.V.',
including the supplementary clause "Extended reservation of title"

We at Pepperl+Fuchs recognise a duty to make a contribution to the future.
For this reason, this printed matter is produced on paper bleached without the use of chlorine.

Table of Contents

1	Declaration of Conformity	5
2	The Used Symbols	7
3	Safety	9
3.1	Intended Use	9
3.2	General Safety Information	9
4	General Information	11
5	Connections, Displays and Controls	13
5.1	Device Schematics	13
5.2	Displays and Controls	14
5.3	Mounting and Connections	15
5.3.1	Mounting	15
5.3.2	Connection via the Power Rail	15
5.3.3	Device Terminal Connections	16
5.3.4	Gateway Power Supply	16
5.4	The PROFIBUS Interface	16
6	Operating the AS-i/PROFIBUS Gateway	19
6.1	Master Start-Up	19
6.2	Configuration Mode	19
6.3	Protected Operating Mode	20
6.3.1	Switching to Protected Operating Mode	20
6.3.2	Configuration Errors in Protected Operating Mode	20
6.4	Assigning an AS-i Address in Configuration Mode	21
6.4.1	Assigning a Slave Address	21
6.4.2	Erasing the Slave Address	21
6.5	Programming the Address in Case of Configuration Errors	22
6.5.1	Automatic Address Assignment	22
6.5.2	Manual Address Assignment	22
6.6	Setting of the Profibus Station Address and the Protocol Type	23
6.6.1	Profibus Station Address	23
6.7	Error Messages	23
7	Advanced Diagnostics for AS-i Masters	25
7.1	List of Corrupted AS-i Slaves (LCS)	25
7.2	Error Counter: Counter of corrupted data telegrams	25
7.3	Off-line Phase on Configuration Errors	25
8	Profibus-DP	27
8.1	Easy Mode	28
8.1.1	Mapping of the AS-i data in the Profibus-DP-Telegram	28
8.1.2	Configuration of the AS-i Network	28

8.1.3	Projecting of the Profibus-DP Master	28
8.1.4	Parameterization of the Profibus-DP Slave	28
8.1.5	Configuration of the Profibus-DP Slave	29
8.2	Advanced Mode	29
8.2.1	Mapping of the AS-i Data in the Profibus-DP Telegram	30
8.2.2	Configuration of the AS-i Network	31
8.2.3	Configuration of the Profibus-DP Master	31
8.3	Professional Mode	34
8.3.1	Mapping of the AS-i Data in the Profibus-DP Telegram	37
8.3.2	Configuration of the AS-i Network	38
8.3.3	Configuration of the Profibus-DP Master	38
8.4	Profibus Diagnosis telegram	41
8.4.1	Diagnosis telegram in easy mode and advanced mode	41
8.4.2	Diagnosis telegram in professional mode	43
9	Accessories for Putting AS-i into Operation and Test Tools	45
9.1	Windows Software AS-i Control Tools	45
9.2	Profibus-DP-Mastersimulator	48
10	Displays of the Figure Display	49
11	Appendix: AS-i Slave Lists and Data Telegrams	51
11.1	AS-i Slave Lists	51
11.2	Execution Control Flags	51
11.3	Structure of the Profibus-DP Data Telegram	52
11.3.1	Structure of the AS-i data window	52
11.3.2	Data Window for Transmission of AS-i Parameters in Advanced Mode	53
11.3.3	Transmission Window for AS-i Control Code in Advanced Mode	53
12	Appendix: The First Commissioning of AS-i	57
13	Appendix: Putting Profibus into Operation with a Siemens S5	59
13.1	Putting into Operation in Easy Mode	59
13.2	Putting into Operation in Professional Mode	62

1 Declaration of Conformity

The AS-i/PROFIBUS Gateway VAG-PB-G4F-R4 have been developed and produced in accordance with the applicable European standards and directives.



Note

The corresponding of conformity can be requested from the manufacturer.

The manufacturer of the product, Pepperl & Fuchs Group in D- 68307 Mannheim, possesses a certified quality assurance system in accordance with ISO 9001.



AS-Interface Declaration of Conformity

Issue date 12.10.1999

2 The Used Symbols



Warning

This symbol warns the user of possible danger. Failure to heed this warning can lead to personal injury or death and/or damage to equipment.



Attention

This symbol warns the user of a possible failure. Failure to heed this warning can lead to total failure of the equipment or any other connected equipment.



Note

This symbol gives the user important hints.

3 Safety

3.1 Intended Use



Warning

The protection of operating personnel and the system against possible danger is not guaranteed if the control interface unit is not operated in accordance with its intended use.

The device may only be operated by appropriately qualified personnel in accordance with this operating manual.

3.2 General Safety Information



Warning

Safety and correct functioning of the device cannot be guaranteed if any operation other than that described in this operation manual is performed.

The connecting of the equipment and any maintenance work to be carried out with voltage applied to the equipment must only be performed by appropriately qualified electrotechnical personnel.

In the case that a failure cannot be repaired, the device must be taken out of operation and kept from inadvertently put back into operation.

Repair work is to be carried out by the manufacturer only. Additions or modifications to the equipment are not allowed and void the warranty.



Note

The operator is responsible for the observance of local safety standards.

4 General Information

This operating instruction is for use with the following devices of the Pepperl+Fuchs GmbH:

- VAG-PB-KF-R4

The AS-i/PROFIBUS-Gateways serve to connect the Actuator-Sensor-Interface to the PROFIBUS-DP. A gateway represents the master for the AS-Interface and the slave for the PROFIBUS.

The AS-i/PROFIBUS-Gateway is constructed as a PROFIBUS DP slave only. It supports all PROFIBUS transmission rates up to 12 MBaud.

All AS-Interface functions can be called via the Profibus. There are three operation modes for the data exchange with Profibus-DP: the easy mode, the advanced mode and the professional mode. In the **easy mode**, the gateway uses a fixed I/O-configuration for the Profibus and the gateway can be put into operation very easily without further parameterization on the Profibus master. In the **advanced mode**, the size of the I/O window can be matched to the actual structure of the AS-i network. The AS-i master is configured by the Profibus master. During operation, AS-i parameters can be transmitted to the AS-i slaves. Also the mini-PLC AS-i Control is accessible. All AS-i Control functions are available (program download, upload, start, stop, read and write user memory). The **professional mode** is the advancement of the advanced mode. With its management channel it is additionally possible to execute further AS-i commands via Profibus. Furthermore you can operate the advanced AS-i diagnosis via Profibus.

The scope of delivery includes several GSD-files to ensure the easy putting into operation in each operating mode. It contains also the Siemens type files version 4.0 (German) and 5.x.

All devices contain the integrated mini-PLC AS-i Control for the fast distributed pre-processing of AS-i data. Furthermore advanced AS-i diagnosis functions are implemented to locate sporadically occurring configuration errors and to judge the quality of the AS-i communication.

All devices are delivered together with the AS-i Control Tools, a Windows software for the easy putting into operation of the AS-Interface and the programming of AS-i Control. The software communicates via the serial interface of the PC without additional expensive hardware. Merely a Profibus converter is needed to connect the RS232 interface of the PC with the Profibus interface of the AS-i/PROFIBUS Gateway.

If no PC is available the putting into operation, troubleshooting and setting up of the AS-i parameters can be accomplished with the use of two push-buttons, the display and the LEDs directly on the device.

5 Connections, Displays and Controls

5.1 Device Schematics

The following are found on the front of the AS-i/Profibus gateway (see diagram below):

1. Connection terminals for the AS-i circuit, also used for the power supply
2. A nine pin SUB-D connector as a Profibus-interface (see chapter 4.5),
3. 7 LEDs
4. A four position, seven section display for indicating the gateway's operating status
5. 2 buttons for projecting the gateway.

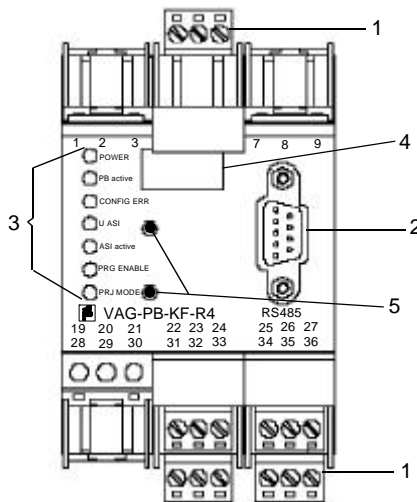

The following diagram provides the dimensions of the AS-i/PROFIBUS-gateway.

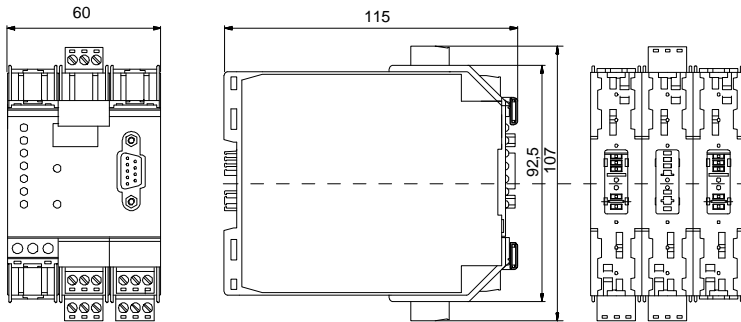

5.2 Displays and Controls

The seven LEDs on the front of the gateway signal the following:

- | | |
|-------------|--|
| power | The gateway is sufficiently supplied with power. |
| PB active | LED on: The PROFIBUS communications are active.
LED off: PROFIBUS communications are inactive. |
| config err | A configuration error is imminent or no PROFIBUS communications are taking place (when the "PB active" LED is not illuminated). This means that with configuration errors, at least one projected slave is missing or the actual configuration data does not correspond with the reference configuration data for a projected and recognized slave. |
| U AS-i | The AS-i line is sufficiently supplied with power.
(AS-i Flag "APO"). |
| AS-i active | Standard operation is active (AS-i Flag "Normalbetrieb"). |
| prg enable | Automatic address programming is possible
(AS-i Flag "Auto_prog_available").
Precisely one slave is missing in the protected operating mode. This slave can be replaced with a slave of similar design and an address of 0. The gateway automatically programs the new slave to the faulty address and thereby resolves the configuration error. |
| prj mode | The gateway is in the projection mode
(AS-i Flag "projecting_active"). |

The two buttons have the following functions:

- mode Used to switch between the projection mode and the protected operating mode and to store the actual AS-i configuration as the reference configuration.
- set Selection and storage of an AS-i slave address.

5.3 Mounting and Connections

5.3.1 Mounting

The KF... design of the gateway can be mounted on a 35 mm DIN rail in accordance with EN 50022 and facilitates electrical connection through the "Power Rail". It is also possible to use the more conventional and expensive method of cable connections to terminals with this design.

The gateway is snapped directly onto the DIN rail. When using the power rail, an electrical connection is automatically made (to the AS-i Bus) by snapping the gateway onto the rail leads..

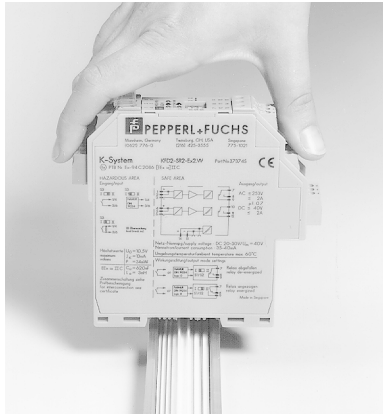

5.3.2 Connection via the Power Rail

The PR05 power rail is an insert for the DIN rail in accordance with EN 50 022. The UPR 05 is delivered with the appropriate DIN rail.

The 5 pin version of the power rail must be used during the establishment of AS-i-interface circuits. Two of the five power rails make up the AS-i bus.

Lead breakage as well as a short circuit caused by the power rail is prevented due to the power rail's solid construction..

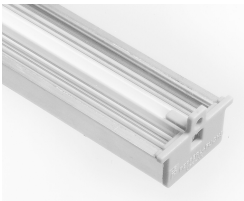

UPR 05

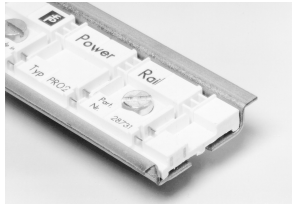

PR 05

5.3.3 Device Terminal Connections

In addition to or in combination with power rail connections, the KF... designs can be conventionally connected by means of removable device terminals. The terminal arrangement is shown below.

The device terminals consist of screw type cable piercing terminals which allow for the connection of 14 AWG cables (2.5 mm²). The connectors are 3 pin connectors; they can be keyed to prevent connection errors.

Removable terminals simplify the assembly of the switch enclosure and allow for the replacement of components without taking the system off line.

5.3.4 Gateway Power Supply

The gateway is supplied through the AS-i circuit. A connection to the AS-i cable is established by means of the power rail and/or with the device terminals. The terminal layout is displayed in the diagram above.

It is important to note when using the power unit that these AS-Interfaces are compatible and have the necessary decoupling coils.

5.4 The PROFIBUS Interface

The serial interface is a 9 pin SUB-D connector. It is located on the right side of the device front. The other possibility is to use the device terminals. The wiring is shown in the picture below:

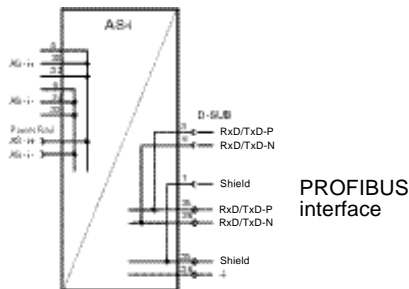

The AS-i/Profibus-Gateway with an RS485 interface transmits and receives through pins 3 and 8 of the SUB-D connector or terminals 25 and 26 of the device terminals. The Rx-D-TxD-P signal (B cable per PROFIBUS specifications) is assigned to pin 3

Issue date 12.10.1999

and to terminal 25. The RxD/TxD-N signal (A cable per PROFIBUS specifications) is assigned to pin 8 and to terminal 26.

In order to prevent equalizing currents, the interface cable's shielding is connected with the gateways grounding clamp through a capacitor. Otherwise, it should be galvanically grounded.

6 Operating the AS-i/PROFIBUS Gateway

6.1 Master Start-Up

After powering on, all segments of the figure display and all LEDs light up for approximately one second (self-test). Afterwards, the LEDs display the condition of their respective flags. The LCD displays the condition of the master:

- 40 Off-line Phase
The AS-i Master initializes—there is no data communication on the AS-i.



If the AS-i circuit is insufficiently powered ("U ASI" does not light up) or there is no communication relationship between the Profibus master and the AS-i/PROFIBUS Gateway, the master remains in the off-line phase.

In configuration mode or when an AS-i Control program is started automatically the device can leave the Off-line phase.

In protected mode, if the Profibus communication is interrupted, the AS-i Master switches to the off-line phase after the watchdog time of the Profibus has expired unless an AS-i Control program is running and was started automatically.

- 41 Detection Phase
Start of the start-up phase, where the system looks for slaves located on the AS-i. The master remains in the detection phase until it finds at least one slave.

- 42 Activation Phase
Condition at the end of the start-up operation where the parameters are transmitted to all connected and recognized slaves. This enables access to the AS-i slaves' data connections.

- 43¹ Start of Normal Operation
In normal operation the AS-i master can exchange data with all active slaves. It transmits management messages and looks for and activates newly connected slaves. During normal operation, the system keeps the maximum cycle time of 5 milliseconds.

6.2 Configuration Mode

The configuration mode serves to configure the AS-i circuit.



In the configuration mode, all recognized slaves are activated even when the desired and actual configurations do not match.

1. Activation phase and the start of normal operation may be so short that the numbers can not be seen in the display.

Pressing the “mode” button for at least five seconds switches the master to configuration mode. While in configuration mode, the yellow “prj mode” LED lights up.

The system then displays one after the other all detected slaves at a speed of two per second. If the display is empty, no slaves were detected on the AS-i circuit.

In configuration mode, all recognized slaves are activated except of slave zero. The AS-i Master is in normal operation. There is data exchange between the AS-i Master and all AS-i slaves detected by the master regardless of whether the detected AS-i slaves were projected before.

When delivered the AS-i/PROFIBUS Gateway is in configuration mode.

6.3 Protected Operating Mode



In contrast with the configuration mode in the protected mode there is only data exchange between the AS-i Master and the projected AS-i slaves.

Note

6.3.1 Switching to Protected Operating Mode



You leave the configuration mode by pressing the “mode” button.

Note

Pressing the button shortly:

Exits the configuration mode without projecting the current AS-i configuration.

Pressing the button for more than five seconds:

Exits the configuration mode and projects the actual AS-i configuration. Simultaneously the actual AS-i configuration is stored as nominal configuration in the EEPROM.



If the system detects an AS-i slave with address zero on the AS-i, it can not leave the configuration mode.

Note

In the protected operating mode, only AS-i slaves that are projected and whose actual configurations match the nominal configurations will be activated.

6.3.2 Configuration Errors in Protected Operating Mode

As long as there is no configuration error, the numeric display is turned off while in protected operating mode. Otherwise, the that address a faulty assignment is displayed. A faulty assignment occurs when a slave has been recognized or projected but cannot be activated.

If there are more than one faulty assignments the one that was first detected is displayed. Pressing the “set” button shortly displays the next higher faulty address.

Shortly appearing configuration errors are stored in the device (advanced AS-i diagnosis). The last error that occurred can be displayed by pressing the set button. If a short AS-i power failure is responsible for the configuration error the display shows a “39”.

6.4 Assigning an AS-i Address in Configuration Mode

AS-i can be put into operation in a very comfortable manner by using the Windows software AS-i Control Tools (see chapter 9.1)(addressing directly or with the AS-i address assistant).

Furthermore you can use a hand held addressing device.

If you don't have neither a PC nor a hand held addressing device, address assigning of the AS-i slaves is also possible with the AS-i/PROFIBUS Gateway using the push buttons. How it works is described as follows.

6.4.1 Assigning a Slave Address

(assigning an available address to a slave with address zero)

In configuration mode, the addresses of all detected slaves are displayed one after the other. To display the next higher available operating address, press the “set” button shortly. Each time you press the “set” button, the next available address is displayed.

Chose the displayed address as your target address by pressing the button for more than five seconds. The address display blinks. The master is ready for programming; pressing the “set” button again addresses the connected slave with address zero to the target (blinking address).

Any errors will be displayed by their error codes according to chapter 10. Otherwise, the detected slaves are displayed again as described in chapter 6.2.

6.4.2 Erasing the Slave Address

AS-iIn configuration mode, the addresses of all recognized slaves are displayed one after the other. By pressing and releasing the “set” button, the master displays the next available address. If you press the button for more than five seconds while the address of a detected slave is displayed, this slave is will get the address zero and the display shows “00”.

When you release the button, the display continues to display the detected slaves.

6.5 Programming the Address in Case of Configuration Errors

6.5.1 Automatic Address Assignment



Note

One of AS-i's great advantages is the automatic address assignment. If a slave fails, it can be replaced by one of the same type with address zero. The master will detect the replacement and automatically addresses the new slave with the address of the faulty one.

For automatic programming to work, some requirements must be met:

1. The AS-i master must be in the protected operating mode.
2. The "Auto_Address_Assign" release flag must be set.
3. Only one of the projected slaves may not be detected.

If these requirements are met, the AS-i master's "prg enable" LED lights up and a slave with address zero will be automatically assigned to the operating address of the missing slave.



Attention

If the two slaves have different configuration data, i.e. are not of the same type as far as AS-i is concerned, the automatic address assignment will not be carried out.

6.5.2 Manual Address Assignment



Note

If several slaves fail, they cannot be replaced automatically by the AS-i master. You must set their addresses manually. If this should not be done via the Profibus interface (using the AS-i Control Tools) or with a hand held addressing device, you can set them with the push buttons and the figure display of the device.

In protected operating mode, wrong assignments are displayed as errors (see chapter 6.3). By pressing the "set" button, you can display all faulty assignments one after the other. By pressing the "set" button for more than five seconds, you can select the currently displayed address as a potential target address, and the display starts to blink.

If the faulty slave was previously replaced by a slave with address zero, the new slave can now be programmed for the blinking address by pressing the "set" key again. As a requirement, the new slave's configuration data must match the configuration data for the blinking address.

After the address has been successfully set, the next faulty assignment is displayed and the address assignment can begin from the start. Otherwise, the system displays an error code (chapter 10). When all faulty assignment are eliminated the display is empty.

6.6 Setting of the Profibus Station Address and the Protocol Type

6.6.1 Profibus Station Address



Note

The addressing of the AS-i/PROFIBUS Gateway as a Profibus slave can be done locally at the gateway or via Profibus according to the Profibus norm.

Station addresses from 1 to 99 can be set, when delivered station address 3 is set. For the relocation, both the "set" button and the "mode" button have to be pushed simultaneously for at least 5 seconds until the current bus address is shown on the LCD display. With every pushing of the "set" button, the station address can now be increased by 1.

Once the desired Profibus station address is shown on the display, it will be stored non-volatile in the EEPROM by pushing the "mode" button.

6.7 Error Messages



Attention

The system displays error codes for error messages that do not point to faulty assignments on the AS-i-circuit. The code numbers are larger than 50 and are therefore outside the slave address range. These codes are described in the appendix, chapter 10.

7 Advanced Diagnostics for AS-i Masters

The advanced AS-i diagnostics serves to locate occasionally occurring errors and to judge the quality of data transmission on AS-i without additional diagnostics tools.

The AS-i Control Tools, Bihl+Wiedemann's software for the comfortable commissioning of the AS-i-Interface and the programming of AS-i Control, will include the operation of the Advanced Diagnostics from version 3.0 on.

7.1 List of Corrupted AS-i Slaves (LCS)

To locate occasionally occurring short-time configuration errors the AS-i Masters with advanced diagnostics manage beside the list of projected slaves (*LPS*), the list of detected slaves (*LDS*) and the list of activated slaves (*LAS*) a forth list, the **list of corrupted slaves (LCS)**. This list contains entries of all AS-i slaves which were responsible for at least one configuration error since powering up the AS-i master or reading the list. Short-time AS-i power failures are represented in the *LCS* at the position of AS-i slave with address 0.



Note

With every read access the LCS will be deleted.



Note

The last short-time configuration error can also be displayed on the AS-i Master:

Pressing the "set" button of the AS-i Master shows the AS-i slave which was responsible for the last short-time configuration error. Was there a short-time AS-i power failure the display shows "39" after pressing the "set" button.

7.2 Error Counter: Counter of corrupted data telegrams

The AS-i Master with advanced diagnostics has an error counter for each AS-i slave, which is increased every time there is a corrupted AS-i telegram. This makes it possible to judge the quality of the AS-i network, even if only a few corrupted telegrams occurred and the AS-i slave did not cause any configuration errors.



Note

The counter values can be read via the host interface and will be deleted with every read access. The counter value is limited to 254. 255 means counter overflow.

The error counter is included in the command Master | AS-i Diagnostics of AS-i Control Tools version 3.0.

7.3 Off-line Phase on Configuration Errors

The AS-i Masters with advanced diagnostics offer the possibility to put themselves into the Off-line Phase when a configuration error on the AS-Interface occurs. In this

way the security of the application can be ensured. The reaction to a configuration error is very fast and the host can be relieved from this task. If there are any problems on the AS-i network, the AS-interface can be switched to a secure state.

There are two different ways to parameterize the AS-i Master for this feature:

- Every configuration error during normal operation in protected mode releases the Off-line Phase.
- For each slave address can be chosen whether a configuration error on this address will release the Off-line Phase or not. This information is stored in the List of Off-line Slaves (*LOS*).

The user himself can decide how the system reacts to a configuration error on the AS-interface. The AS-i Master can release the Off-line Phase in critical situations, i.e. only with certain slave addresses, while in less critical situations (if one of the other AS-i slaves have a configuration error) only the error message configuration error is sent to the host, but AS-i is still running.

The parameterization of Off-line Phase on Configuration Error is also supported by the AS-i Control Tools version 3.0.

8 Profibus-DP

In this chapter, you learn everything necessary to run the AS-i/PROFIBUS Gateway in a Profibus-DP network.

For data exchange on Profibus-DP there are three operation modes: the easy mode, the advanced mode and the professional mode (advanced mode with management channel).



Hint: If you try to put an AS-i/PROFIBUS Gateway in operation the first time it is advisable to use the easy mode because it is much easier than the advanced modes.

Note

The following table shows the differences between the three modes:

following Functions are available	in easy mode	in advanced mode	in professional mode
Transmission of AS-i input and output data	X	X	X
AS-i circuit can be configured locally on the gateway	X	-	X
Putting into Operation without additional parameterization of the Profibus master	X	-	-
Working with a standard I/O-configuration on Profibus-DP	X	-	-
Detection of AS-i errors via DP-diagnosis	X	X	X
Transmission of AS-i parameters to the gateway while the system is running (e.g. switching of the measurement range of sensors)	-	X	X
Configuring and parameterizing the AS-i circuit by the DP-master	-	X	X
Reading and Writing AS-i Control programs via Profibus-DP	-	X	-
AS-i Transmission of user flags for the AS-i Control program via Profibus DP	-	X	X
Adjust the size of the I/O windows to the actual extension of the AS-i circuit	-	X	X
Transmission of additional AS-i commands and advanced diagnosis	-	X	X

8.1 Easy Mode

8.1.1 Mapping of the AS-i data in the Profibus-DP-Telegram

The inputs and outputs of the AS-i network are mapped identically in the DP master's input or output memory area respectively. In the easy mode the DP-telegram contains 16 bytes in- and output data with a single master.

AS-i circuit 1:

Byte 0	Byte 1	...	Byte 15
Slave 1, AS-i flags	Slave 3, Slave 2	...	Slave 31, Slave 30

The AS-i flags and every AS-i slave take up four bits. The meaning and allocation of these bits is explained in the appendix, chapter 11.3.1.



If the AS-i flags shall not be used, you have to make sure that by all means these four bits are set to zero.

Warning

8.1.2 Configuration of the AS-i Network

The AS-i network can be put into operation without the Profibus-DP master. A connection to the Profibus-DP master is not necessary.

A comfortable way to configure the AS-i circuit on the AS-i/PROFIBUS Gateway is to use the Windows software AS-i Control Tools.

However it is also possible to configure the AS-i network locally on the gateway by using the push buttons "set" and "mode" (see chapter 6.4)

8.1.3 Projecting of the Profibus-DP Master

To project the Profibus-DP network you have to copy a GSD-file (enclosed on diskette) to the working directory of your Profibus configuration software (some programs have a directory named GSD, where the GSD-files have to be copied to, please see the manual of the used software). Depending on the software you may have to dispatch a command like „read GSD-files“.

The GSD-files can be found on the enclosed diskette „AS-i/PROFIBUS-Gateway IBM PC Software“ in the directory GSD.

For the easy mode the following GSD-files are available:

```
bwes1742.gsd
    device: AS-i/PROFIBUS-DP Gateway,
    model name in the GSD-file: „AS-i/DP“
```

If the Profibus configuration software needs the older type files instead of the GSD-files, please read the file \gsd\readme.txt on the enclosed diskette.

8.1.4 Parameterization of the Profibus-DP Slave

The parameters the gateway needs are completely appropriated by the GSD-file, there is no need to state user-parameters. If nevertheless user-parameters are transmitted, the device will switch to easy mode, if the first byte (element selection) is 00_{hex}.

issue date 12.10.1999

8.1.5 Configuration of the Profibus-DP Slave

In the easy mode the gateway uses a fixed I/O-configuration. If you use the GSD-file select the module "Standardmodus".

If you configure the master without the GSD-file, select the identification byte $3F_{hex}(=63_{dec})$.

For double masters you need this identification byte for each AS-i circuit.

8.2 Advanced Mode



Note

*For AS-i/PROFIBUS Gateways with 2 AS-i Masters and/or the advanced AS-i diagnostics¹ we recommend to use the **professional mode** instead of the older advanced mode.*

The extended functionality of the advanced mode affords a more extensive configuration of Profibus-DP. The I/O window can be adjusted optimally to the additional transmitted data (AS-i parameters, user memory, AS-i Control Code). The length of the I/O-window depends on the following factors:

- number of the AS-i slaves (number of input and output bytes)
- shall AS-i parameters be transmitted?
- shall AS-i Control code be transmitted?
- shall user memory be transmitted?

Size of the Window for the AS-i Input and Output Data

The size of the window for the AS-i input and output data is automatically adjusted to the AS-i configuration that is transmitted in the Profibus parameter telegram (user-parameter).

However, you must pay attention to this when configuring the Profibus-DP slave (see chapter 8.2.3).

Transmission of AS-i Parameters

For the transmission of AS-i parameters the DP-input and output data fields are enlarged by two bytes each. The AS-i slave address and the AS-i parameters are entered to these bytes. In the output data field, the DP master deposits the AS-i parameters to be written; in the input data field, the gateway deposits the data read during the AS-i parameterization.

The AS-i slaves are parameterized sequentially, i. e. only one slave can be parameterized in one Profibus cycle. The gateway signals errors of the parameterization by setting the leftmost bit in the slave address.

Transmission of AS-i Control code

1. these are all devices that were delivered since September 1998; these devices have the following feature string: „B..Dc..***.....“ oder „B..Dc2..***.....“, * is a placeholder for various characters (this string can be read with AS-i Control Tools with the command Master | Identity)

For the programming of AS-i Control, the I/O field is further enlarged by 5-17 additional bytes. They contain an identification byte (read/write/start/stop), the base address and 2-14 bytes user data. It is not possible to read and write at the same time.

Transmission of user memory

User memory can be transmitted in the I/O field by adding bytes for the memory locations to be written (O-field) or to be read (I-field). The amount of user memory to be written or read can be different.

8.2.1 Mapping of the AS-i Data in the Profibus-DP Telegram

The data in the DP telegram is always mapped in the same fixed order:

- AS-i I/O data
- AS-i parameters
- AS-i Control code
- user memory

If some elements are missing (e.g. no transfer of the AS-i Control code), subsequent elements are added directly.

The individual parts of the DP-telegram are coded as follows:

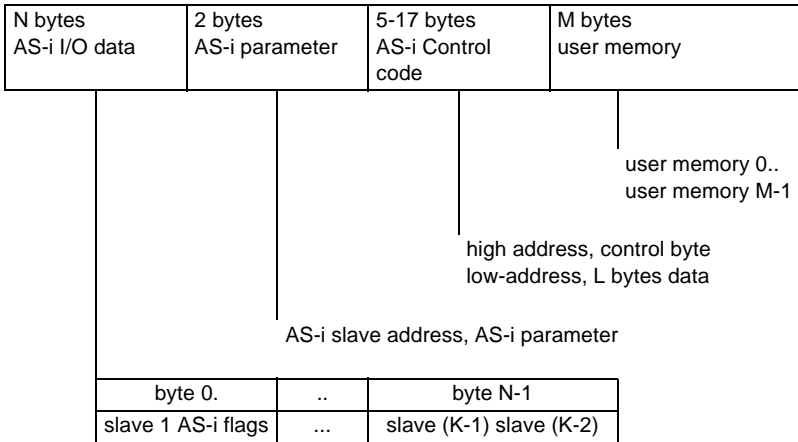

with $K = \text{number of AS-i slaves} + 1$
(instead of slave 0 the AS-i flags are transmitted)

$N = K/2$

$M = \text{number of user memory bytes up to 128 bytes}$

$L = \text{number of bytes of AS-i Control code}$
(calculated out of value in element selection of the user-parameter telegram)

issue date 12.10.1999

The AS-i flags and every AS-i slave take up four bits. The meaning and allocation of these bits is explained in the appendix, chapter 11.3.2.



If the AS-i flags shall not be used, you have to make sure that by all means these four bits are set to zero.

Warning

Bit allocation AS-i parameters: see appendix, chapter 11.3.2.

Constants for the control byte in the DP-telegram's AS-i Control part: see appendix, see chapter 11.3.3.

8.2.2 Configuration of the AS-i Network

During the building up of the connection to a Profibus-DP master, the AS-i network is configured via the Profibus. The AS-i configuration does not have to be stored locally (via the push buttons mode and set or the AS-i Control Tools). Merely the AS-i slaves have to get the designated addresses.

The AS-i/PROFIBUS Gateway compares the nominated AS-i configuration received from the DP-master with the actual configuration of the AS-i network. If they match, the gateway does data exchange on AS-i. (This does not affect the data exchange on Profibus).

The AS-i configuration data of the AS-i slaves (ID-code and I/O-configuration) should be known before configuring the DP-master. You find them in the AS-i slave's documentation.



Note

The configuration via Profibus-DP offers the following advantage: The AS-i configuration data of the AS-i network is stored in the DP-master. This way, an immediate start-up without any need for manual intervention is possible when exchanging the gateway (one exception is the Profibus station address).

8.2.3 Configuration of the Profibus-DP Master

To project the Profibus-DP network you have to copy a GSD-file (enclosed on diskette) to the working directory of your Profibus configuration software (some programs have a directory named GSD, where the GSD-files have to be copied to, please see the manual of the used software). Depending on the software you may have to dispatch a command like „read GSD-files“.

The GSD-files can be found on the enclosed diskette „AS-i/PROFIBUS-Gateway IBM PC Software“ in the directory \GSD.

For the advanced mode the following GSD-files are available:

bwas1742.gsd

device: AS-i/PROFIBUS-DP Gateway,

model name in the GSD-file: „AS-i/DP-A“

If the Profibus configuration software needs the older type files instead of the GSD-files, please read the file \gsd\readme.txt on the enclosed diskette.

Parameterization of the Profibus-DP-Slave

The parameters needed by the gateway are coded in the user-parameters. They contain one byte element selection, the AS-i configuration data and AS-i parameters for all the AS-i slaves and the statements about user memory bytes to be read and to be written.

Element selection	AS-i configuration data and AS-i (startup-) parameters	user memory statement
-------------------	--	-----------------------

The fields are constructed as follows:

- Element selection (1 byte)

Bit field for the selection of the data to be transmitted:

Bit 0 = 1 Transmission of AS-i parameters
 = 0 No transmission of AS-i parameters

Bit 1 = 1 Transmission of user memory
 = 0 No transmission of user memory

Bit 2 = 1 Transmission of 2 bytes of AS-i Control code additionally

Bit 3 = 1 Transmission of 4 bytes of AS-i Control code additionally

Bit 4 = 1 Transmission of 8 bytes of AS-i Control code additionally

Bit 5 = 0 (reserved, 0 cogently necessary)

Bit 6 = 1 Transmission of AS-i input data
 = 0 AS-i input data field is left out

Bit 7 = 1 Transmission of AS-i output data
 = 0 AS-i output data field is left out

If the ID-Byte is set to 00hex, the device will switch to the easy mode.

- AS-i configuration data and AS-i (startup) parameters (62 bytes)

For each AS-i slave 2 bytes are used. AS-i slave 0 is disregarded.

In the first byte, the AS-i configuration data is specified. The AS-i ID-code is coded in the byte's high nibble and the I/O-configuration in its low nibble.

bit 7	bit 6	bit 5	bit 4	bit 3	bit 2	bit 1	bit 0	
ID-code					IO-configuration			

In the second byte's low nibble, the AS-i (startup) parameters are transmitted. The upper half of this byte is unused.

bit 7	bit 6	bit 5	bit 4	bit 3	bit 2	bit 1	bit 0	
0	0	0	0	P3	P2	P1	P0	
unused (=0)					AS-i parameter			

The default parameter for an AS-i slave is F_{hex} , so that normally as second byte $0F_{hex}$ is stated.

Issue date: 12.10.1999

If a slave address is to remain unused, either FF_{hex}, FF_{hex} or 256_{dec}, 256_{dec} has to be entered.



The highest slave address used determines the size of the window for input and output data in the DP-data telegram.

Note

The configuration of the DP-slave has to be adjusted accordingly (see below).

- user memory statement (4 bytes)

The user memory statement always has to be stated.

Byte 0: Start address of the user memory window in the input data telegram (read user memory)

Byte 1: Length of the user memory window in the input data telegram

Byte 2: Start address of the user memory window in the output data telegram (write user memory)

Byte 3: Length of the user memory window in the output data telegram

If user memory bytes shall only to be read or written, the appurtenant length byte has to be set to 0.

If no user memory bytes shall be transmitted it is recommended to set the user memory statement to FF_{hex} FF_{hex} FF_{hex} FF_{hex}.

The maximum length of the user memory window is 128 bytes.

Example: Parameter telegram for the advanced mode:

3 AS-i slaves and transmission of user memory, all slaves AS-i ID 0
 Slave 1: 4 inputs
 Slave 2: 4 outputs
 Slave 3: 2 inputs, 2 outputs
 from user memory byte 0 read 4 bytes of user memory
 no writing of user memory

El.	slave 1		slave 2		slave 3		slave 4		...	slave 31		user mem. st.			
	conf ID,IO	par	conf ID,IO	par	conf ID,IO	par	conf ID,IO	par		conf ID,IO	par				
C2	00	0F	08	0F	03	0F	FF	FF		FF	FF	00	04	00	00

(all data stated in hexadecimal code)

Configuration of the Profibus-DP slave

In contrast to the easy mode, the size of the I/O window can be matched to the extension of the AS-i network. Its size in bytes amounts:

$$(highest\ AS-i\ slave\ address + 1) / 2$$

Any non-integer value has to be rounded up to a full byte. Extra bytes have to be added for possible AS-i (startup) parameters, user memory or AS-i Control code.

Only "standard identification bytes" with a maximum size of 16 bytes or words may be used as identification bytes. If the data windows to be transmitted shall be bigger than 16 bytes or words, they have to be out together out of several "standard identification bytes".

If the requested data field length is smaller than the one calculated out of the parameter telegram, the gateway will not take up any communication relationship with the DP-master.

The maximum data field length for input respectively output data is 149 bytes with a device with one AS-i Master and 160 bytes with a device with two AS-i Masters.

8.3 Professional Mode

All AS-i/PROFIBUS Gateways with 2 AS-i Masters and/or the advanced AS-i diagnostics¹ have a third operation mode, which we call the professional mode. We recommend the use of the professional mode instead of the older advanced mode.

The AS-i/PROFIBUS Gateways with 2 AS-i Masters only allow the use of the easy mode or the professional mode. The AS-i/PROFIBUS Gateways (FMS/DP) only run in the easy mode or the advanced mode.

The extended functionality of the advanced mode affords a more extensive configuration of Profibus-DP. The I/O-window has to be enlarged for the additional data (management commands and user memory). The length of the I/O-window depends on the following factors:

- number of the AS-i slaves (number of input and output bytes)
- size of the management channel (0, 3 or 5 Bytes)
- number of the user memory bytes

Size of the Window for the AS-i Input and Output Data

The size of the window for the AS-i input and output data has to be adjusted to the AS-i configuration (see chapter 8.3.3).

Transmission of Management Commands (0, 3 or 5 bytes)

With the management commands you can transmit acyclically additional AS-i data like e.g. AS-i parameters or reading the LDS or also writing the AS-i Control flags e.g. to start an AS-i Control program.

The management channel uses either 3 or 5 bytes. If the commands write LPS, read LPS, read LAS, read LDS, read LCS, read communication errors, write LOS or read LOS shall be used, the management channel has to have a length of 5 bytes because these commands use 4 bytes of data.

The management channel is built up as follows:

	byte 0	byte 1 - 2 respectively 1 - 4
Profibus output data	command byte	output data
Profibus input data	mirrored command byte	input data

1. these are all devices that were delivered since September 1998; these devices have the following feature string:
 „B.Dc.***.....“ oder „B.Dc2.***.....“, * is a placeholder for various characters
 (this string can be read with AS-i Control Tools with the command Master | Identity)

If the same command byte shall be sent several times one after the other, the bit 7 (valence 2^7) has to be toggled each repetition.

The bit 6 (valence 2^6) of the command byte states the number of the AS-i Masters to address to. If this bit is 0, AS-i Master 1 is addressed, otherwise AS-i Master 2. With single masters this bit has to be 0, with double masters the AS-i circuit to address can be selected. (e.g. command read AS-i Control Flags of AS-i circuit 2: $4D_{hex}$)

After execution of the command the command byte is mirrored. Illegal commands (AS-i circuit number 2 with single masters, illegal command byte or a data field which is too short) always return as mirrored command byte 00_{hex} or 80_{hex} , if the toggle bit was set.

Commands that may fail return an error code (00_{hex} : OK, FF_{hex} : error) in data byte[0] (status).

The possible commands are listed as follows:

AS-i function		command byte	data byte[0]	data byte[1]	data byte[2]	data byte[3]
Idle (no function)	output	00_{hex}	-	-	-	-
	input	00_{hex}	-	-	-	-
write projected parameter	output	01_{hex}	slave address	parameter	-	-
	input	01_{hex}	status	-	-	-
read projected parameter	output	02_{hex}	slave address	-	-	-
	input	02_{hex}	status	parameter	-	-
write parameter	output	03_{hex}	slave address	parameter	-	-
	input	03_{hex}	status	parameter	-	-
read actual parameter	output	04_{hex}	slave address	-	-	-
	input	04_{hex}	status	parameter	-	-
write (project) actual parameter	output	05_{hex}	-	-	-	-
	input	05_{hex}	status	-	-	-
write projected configuration	output	06_{hex}	slave address	conf.-daten	-	-
	input	06_{hex}	status	-	-	-
read projected configuration	output	07_{hex}	slave address	-	-	-
	input	07_{hex}	status	conf.-daten	-	-
write projected configuration	output	08_{hex}	-	-	-	-
	input	08_{hex}	status	-	-	-
read actual configuration	output	09_{hex}	slave address	-	-	-
	input	09_{hex}	status	conf.-daten	-	-
address AS-i slave	output	$0A_{hex}$	old address	new address	-	-
	input	$0A_{hex}$	status	-	-	-

Issue date 12.10.1999

AS-i function		command byte	data byte[0]	data byte[1]	data byte[2]	data byte[3]
AS-i command call	output	0B _{hex}	slave address	data	-	-
	input	0B _{hex}	status	answer	-	-
write AS-i Control flags	output	0C _{hex}	flags	-	-	-
	input	0C _{hex}	flags	-	-	-
read AS-i Control flags	output	0D _{hex}	-	-	-	-
	input	0D _{hex}	flags	-	-	-
write LPS	output	0E _{hex}	LPS	LPS	LPS	LPS
	input	0E _{hex}	status	-	-	-
read LPS	output	0F _{hex}	-	-	-	-
	input	0F _{hex}	LPS	LPS	LPS	LPS
read LAS	output	10 _{hex}	-	-	-	-
	input	10 _{hex}	LAS	LAS	LAS	LAS
read LDS	output	11 _{hex}	-	-	-	-
	input	11 _{hex}	LDS	LDS	LDS	LDS
read LCS	output	12 _{hex}	LCS	LCS	LCS	LCS
	input	12 _{hex}		-	-	-
read communication error	output	13 _{hex}	index (0-7)	-	-	-
	input	13 _{hex}	error	error	error	error
write LOS	output	14 _{hex}	LOS	LOS	LOS	LOS
	input	14 _{hex}	-	-	-	-
read LOS	output	15 _{hex}	-	-	-	-
	input	15 _{hex}	LOS	LOS	LOS	LOS

remarks to the table:

- possible values for status:

The status byte, which is returned from certain commands, can have the following values:

FF error occurred at execution of the host command

00 no error occurred

If errors occur while changing slave addresses, the status byte contains one of the following error codes:

01 no failure.

02 the slave, whose address should be changed does not exist.

03 There is a slave with address zero.

- 04 The address to which the slave shall be addressed is reserved by another slave
- 05 The slave could not be addressed to address 0.
- 06 The new operation address could not be assigned.
- 07 The new operation address could not be stored in the EEPROM of the slave.

- AS-i command call :

The function of the execution control `Execute_Command()` is executed. The information part of the master request has to be stated in "data". (see AS-i specification).

The AS-i Master stores the slave answer in the byte "answer".

- LPS, LAS, LDS, LCS, LOS:

Structure of the AS-i slave lists see appendix, chapter 11.1.

- read communication errors:

For each slave there is one byte for the number of communication errors that occurred since the last read access. With every read access only 4 bytes are read simultaneously. Therefore you have to state the index for the data you want to read:

$$\text{index} = \text{slave address} / 4 \text{ (integer)}$$

$$\text{data byte number} = \text{slave address} - (4 * \text{index})$$

Transmission of user memory

The user memory is transmitted in an own Profibus slot. The amount of user memory to be written or read can be different.

8.3.1 Mapping of the AS-i Data in the Profibus-DP Telegram

The data in the DP telegram is always mapped in the same fixed order:

- AS-i I/O data
- AS-i parameters
- AS-i Control code
- user memory

If some elements are missing (e.g. no transfer of the AS-i Control code), subsequent elements are added directly.

The AS-i data is represented in the DP-telegram as follows:

byte 0	byte 1	...	byte N-1
slave 1, AS-i flags	slave 2, slave 3	...	slave(K-1), slave(K-2)

with $K = \text{number of AS-i slaves} + 1$
(instead of slave 0 the AS-i flags are transmitted)

$$N = K/2$$

The AS-i flags and every AS-i slave take up four bits. The meaning and allocation of these bits is explained in the appendix, chapter 11.3.1.



Warning

If the AS-i flags shall not be used, you have to make sure that by all means these four bits are set to zero.

8.3.2 Configuration of the AS-i Network

During the building up of the connection to a Profibus-DP master, the AS-i network is configured via the Profibus, unless the AS-i configuration and the AS-i (startup) parameters are not stated in the Profibus parameter telegram. The AS-i configuration only has to be stored locally (via the push buttons mode and set or the AS-i Control Tools), if the configuration of AS-i was not stated in the Profibus parameter telegram. Merely the AS-i slaves have to get the designated addresses.

The AS-i/PROFIBUS Gateway compares the nominated AS-i configuration received from the DP-master with the actual configuration of the AS-i network. If they match, the gateway does data exchange on AS-i. (This does not affect the data exchange on Profibus).

The AS-i configuration data of the AS-i slaves (ID-code and I/O-configuration) should be known before configuring the DP-master. You find them in the AS-i slave's documentation.



Note

The configuration via Profibus-DP offers the following advantage: The AS-i configuration data of the AS-i network is stored in the DP-master. This way, an immediate start-up without any need for manual intervention is possible when exchanging the gateway (one exception is the Profibus station address).

If the AS-i configuration and the AS-i (startup) parameters were not stated in the Profibus parameter telegram AS-i has to be projected (and the configuration stored) with the push buttons at the device or with the windows software AS-i Control Tools.

8.3.3 Configuration of the Profibus-DP Master

To project the Profibus-DP network you have to copy a GSD-file (enclosed on diskette) to the working directory of your Profibus configuration software (some programs have a directory named GSD, where the GSD-files have to be copied to, please see the manual of the used software). Depending on the software you may have to dispatch a command like "read GSD-files".

The GSD-files can be found on the enclosed diskette „AS-i/PROFIBUS-Gateway IBM PC Software“ in the directory \GSD.

For the professional mode the following GSD-files are available:

bwps1742.gsd
device: AS-i/PROFIBUS-DP Gateway
model name in the GSD-file: „AS-i/DP-Profi“

Parameterization of the Profibus-DP-Slave

The parameters needed by the gateway are coded in the user-parameters. They contain one byte to select the professional mode, the AS-i configuration data and AS-i parameters for all the AS-i slaves and the statements about user memory bytes to be read and to be written.

20 _{hex}	user memory statement (4 bytes)	AS-i configuration data and AS-i (startup-) parameters of AS-i circuit 1 (62 bytes)	AS-i configuration data and AS-i (startup-) parameters of AS-i circuit 2 (62 bytes)
-------------------	---------------------------------	---	---

The fields user memory statement and AS-i configuration data and AS-i (startup-) parameters are optional. However the order of the fields is stipulated. Therefore the following four combinations are possible:

1.

20 _{hex}

2.

20 _{hex}	user memory statement (4 bytes)
-------------------	---------------------------------

3.

20 _{hex}	user memory statement (4 bytes)	AS-i configuration data and AS-i (startup-) parameters of AS-i circuit 1 (62 bytes)
-------------------	---------------------------------	---

4.

20 _{hex}	user memory statement (4 bytes)	AS-i configuration data and AS-i (startup-) parameters of AS-i circuit 1 (62 bytes)	AS-i configuration data and AS-i (startup-) parameters of AS-i circuit 2 (62 bytes)
-------------------	---------------------------------	---	---

In the cases 1 and 2 no AS-i configuration data and AS-i (startup-) parameters are stated in the user parameter telegram. In these cases the AS-i configurations stored in the EEPROM of the AS-i/PROFIBUS Gateway are used. So AS-i can be projected using the AS-i Control Tools or the push buttons on the device before Profibus is put into operation.

The fields of the Profibus parameter telegram are constructed as follows:

- user memory statement (4 bytes)
 - Byte 0: Start address of the user memory window in the input data telegram (read user memory)
 - Byte 1: Length of the user memory window in the input data telegram

Byte 2: Start address of the user memory window in the output data telegram (write user memory)

Byte 3: Length of the user memory window in the output data telegram

If user memory bytes shall only to be read or written, the appurtenant length byte has to be set to 0.

If no user memory bytes shall be transmitted it is recommended to set the user memory statement to $FF_{hex} FF_{hex} FF_{hex} FF_{hex}$.

The maximum length of the user memory window is 128 bytes.

- AS-i configuration data and AS-i (startup) parameters (62 bytes)

For each AS-i slave 2 bytes are used. AS-i slave 0 is disregarded.

In the first byte, the AS-i configuration data is specified. The AS-i ID-code is coded in the byte's high nibble and the I/O-configuration in its low nibble.

bit 7	bit 6	bit 5	bit 4	bit 3	bit 2	bit 1	bit 0
ID-code					IO-configuration		

In the second byte's low nibble, the AS-i (startup) parameters are transmitted. The upper half of this byte is unused.

Furthermore during the operation of the system AS-i parameters can be transmitted via Profibus in the management channel as described above (command write parameter).

bit 7	bit 6	bit 5	bit 4	bit 3	bit 2	bit 1	bit 0
0	0	0	0	P3	P2	P1	P0
unused (=0)					AS-i parameter		

The default parameter for an AS-i slave is F_{hex} , so that normally as second byte $0F_{hex}$ is stated.

If a slave address is to remain unused, either FF_{hex} , FF_{hex} or 256_{hex} , 256_{hex} has to be entered.

The configuration of the DP-slave (I/O data fields) has to be adjusted according to the highest AS-i slave address.

Example: Parameter telegram for the professional mode:

3 AS-i slaves and transmission of user memory, all slaves AS-i ID 0

Slave 1: 4 inputs

Slave 2: 4 outputs

Slave 3: 2 inputs, 2 outputs

from user memory byte 0 read 4 bytes of user memory

no writing of user memory

				user mem. st.		slave 1		slave 2		slave 3		slave 4		...		slave 31	
				conf	par	conf	par	conf	par	conf	par	conf	par			conf	par
				ID,IO		ID,IO		ID,IO		ID,IO		ID,IO				ID,IO	
20	00	04	00	00	00	0F	08	0F	03	0F	FF	FF			FF	FF	

issue date: 12.10.1993

(all data stated in hexadecimal code)

Profibus Configuration of the Profibus-DP slave

The Profibus configuration of the AS-i/PROFIBUS Gateways built up out of the following Profibus slots:

- process data/AS-i flags of AS-i Master 1
standard identification byte (1..16 bytes) or empty slot
- management channel
standard identification byte 0xB2 (3 bytes) or 0xB4 (5 bytes) or empty slot
- user memory (AS-i Control)
standard identification byte or extended identification byte (altogether up to 128 bytes) or empty slot

Empty slots at the end of the configuration telegram can be left out.

In contrast to the easy mode, the size of the I/O window can be matched to the extension of the AS-i network. Its size in bytes amounts:

$$(highest\ AS-i\ slave\ address + 1) / 2$$

Any non-integer value has to be rounded up to a full byte.

If the requested data field length for the user memory is smaller than the calculated length from the parameter telegram, the gateway will not take up any communication relationship with the DP-master.

The maximum data field length for input respectively output data is 149 bytes with a device with one AS-i Master.

8.4 Profibus Diagnosis telegram

Besides the on-the-spot-diagnosis via the figure display and the seven LEDs, there is also the possibility of a diagnosis via the Profibus-DP. The Profibus diagnosis telegram meets the Profibus norm.

The Profibus diagnosis telegram depends on the operation mode.

8.4.1 Diagnosis telegram in easy mode and advanced mode

The diagnosis telegram contains 9 bytes in the easy mode or the advanced mode. The structure is represented in the following table.

byte	content
0	station status 1
1	station status 1
2	station status 1
3	station number DP-master
4-5	manufacturer code
6	header and length of the device-based diagnosis
7	AS-i slave address
8	type of configuration error

Issue date: 12.10.1999

Whereas the bytes 0 to 5 of the diagnosis telegram are stipulated by the Profibus-DP norm and independent of the used DP slave, bytes 6 to 8 of the diagnosis telegram are used by the AS-i/PROFIBUS Gateway to display any deviation of the actual configuration of the AS-i network from the projected AS-i configuration. If there is no discrepancy the bytes 6 to 8 are left out.

Byte 6:

Header and length of the device-based diagnosis.
This byte always is 03hex.

Byte 7:

Lowest slave address with a configuration error (hexadecimal representation).

Byte 8:

Type of configuration error (hexadecimal representation).

00_{hex}: Projected AS-i slave is missing

F0_{hex}: Actual configuration data differ from projected configuration data
Differences between projected and actual ID-code and I/O-code (only in protected mode of AS-i Master)

FF_{hex}: Not projected AS-i slave on the AS-i circuit detected.

The number of the first detected erroneous slave is transmitted.

Special Error Messages:

- AS-i power fail: The voltage supply on the AS-i network is insufficient.

byte 6	byte 7	byte 8
03 _{hex}	FF _{hex}	00 _{hex}

- At least one slave's actual ID-code and I/O-configuration differ from the projected values (only in configuration mode).

byte 6	byte 7	byte 8
03 _{hex}	FF _{hex}	F0 _{hex}

- Device is not in normal operation, but no AS-i power fail occurred.

byte 6	byte 7	byte 8
03 _{hex}	FF _{hex}	FF _{hex}

- No failure.

byte 6	byte 7	byte 8
03 _{hex}	00 _{hex}	00 _{hex}

8.4.2 Diagnosis telegram in professional mode

The diagnosis telegram contains 24 bytes in the professional mode. The structure is represented in the following table.

byte	content	
0	station status 1	
1	station status 2	
2	station status 3	
3	station number DP-master	
4-5	manufacturer code	
6	length of the device-based diagnosis ($19_{dez}=13_{hex}$)	
7	execution control flags	AS-i Master 1
8-11	configuration error list	
12-15	LCS (List of Corrupted Slaves)	
16	execution control flags	AS-i Master 2
17-20	configuration error list	
21-24	LCS (List of Corrupted Slaves)	

execution control flags see appendix, chapter 11.2.

The configuration error list is built up as the LPS (see appendix, chapter 11.1). A bit in the configuration error list is set, if the concerning bit in the LPS (List of Projected Slaves) differs from the one in the LDS (List of Detected Slaves) or if the projected AS-i configuration data (I/O- and ID-code) of the concerning AS-i slave differ from the detected configuration in the AS-i circuit.

The LCS is explained in chapter 7 (advanced AS-i diagnostics).

9 Accessories for Putting AS-i into Operation and Test Tools

The AS-i circuit on the AS-i/Profibus Gateway can be put into operation with the comfortable Windows software AS-i Control Tools. This software communicates with the AS-i/Profibus Gateway by means of the Profibus converter, which converts the RS232-signals of the PC to Profibus.

The Profibus DP Master Simulator is recommended for testing the gateway. With the Profibus DP Master Simulator the AS-i/Profibus Gateway can be put into operation with or without GSD-file. The user parameter string that is needed for advanced mode or professional mode can be edited and tested. The Profibus DP Master Simulator can also be used as a Profibus converter. Furthermore the Profibus DP Master Simulator can be used for putting any Profibus-DP slave into operation which is very useful for diagnostic purposes.

9.1 Windows Software AS-i Control Tools

The Windows software AS-i Control Tools enables you to configure the AS-i circuit in a very comfortable manner.

1. For that purpose plug in a Bihl+Wiedemann Profibus converter to the D-SUB-connector of the AS-i/PROFIBUS Gateway and connect the device with a fully covered cable to the serial interface of your PC.
2. Start the AS-i Control Tools.
3. Call the command Master | New.

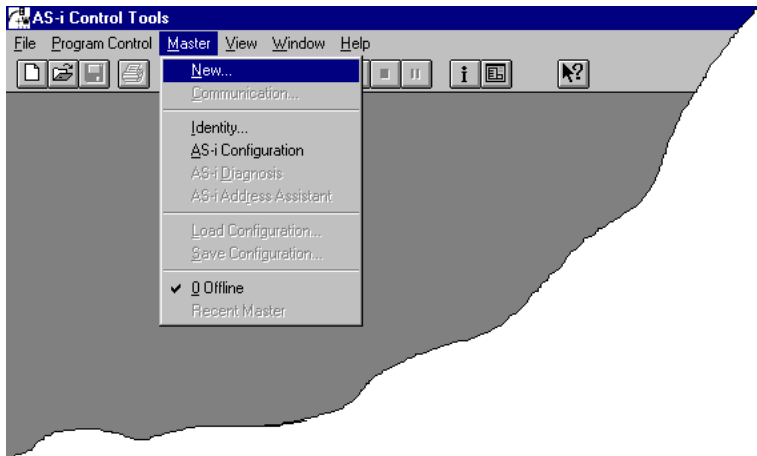

4. Choose Profibus as protocol.

AS-Interface Accessories for Putting AS-i into Operation and Test Tools

5. Do the appropriate settings (e.g. serial interface COM 2, station address <auto>, AS-i circuit 1)

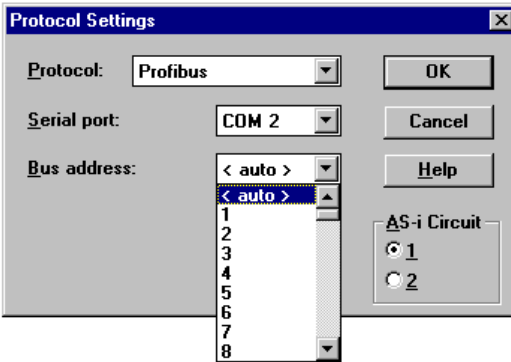

6. Call the command Master | AS-i configuration.
The AS-i configuration editor will be started. All detected and projected AS-i slaves are displayed in this window.

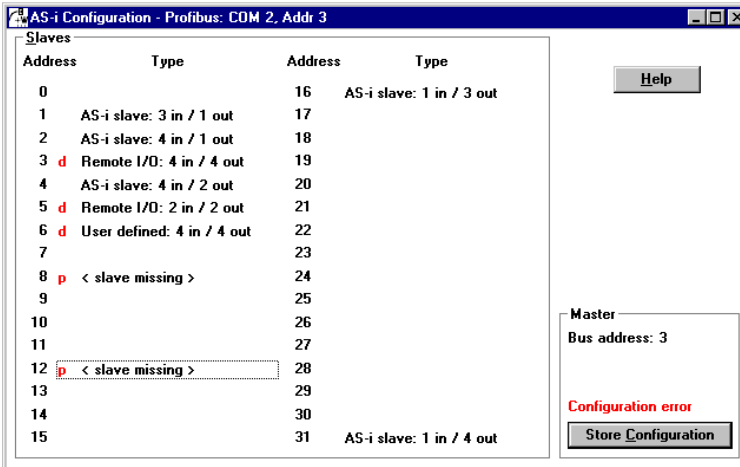

7. Click on a slave entry to open the dialogbox slave configuration.

Slave configuration

Selected Slave: 2

Change address to: 2

Inputs: 0 1 2

Outputs: 3

Current parameters: 0 1 2 3

Power up parameters: 0 1 2 3

Detected: 11 AS-i sensor

Projected: 10 2x2 input module

Username:

Device Type:

This dialog box is for changing a slave address, setting AS-i parameters or AS-i configuration data. Additionally you can test inputs and outputs.

A very easy approach to configure the AS-i circuit is connecting each AS-i slave to the line and setting the AS-i slave address one after the other. After that press the button "Store configuration" to adopt the detected AS-i circuit to the AS-i Master as projected data.

Moreover you can use the **AS-i Address Assistant**. This tool changes automatically the address of an AS-i slave to the desired address after plugging the slave to the AS-i line. The desired AS-i configuration can be created off-line before and stored to a file. When you build up the plant you only have to plug the AS-i slaves to the AS-i line one after the other.

Further descriptions to all features of the software can be obtained from the integrated help.

9.2 Profibus-DP-Mastersimulator

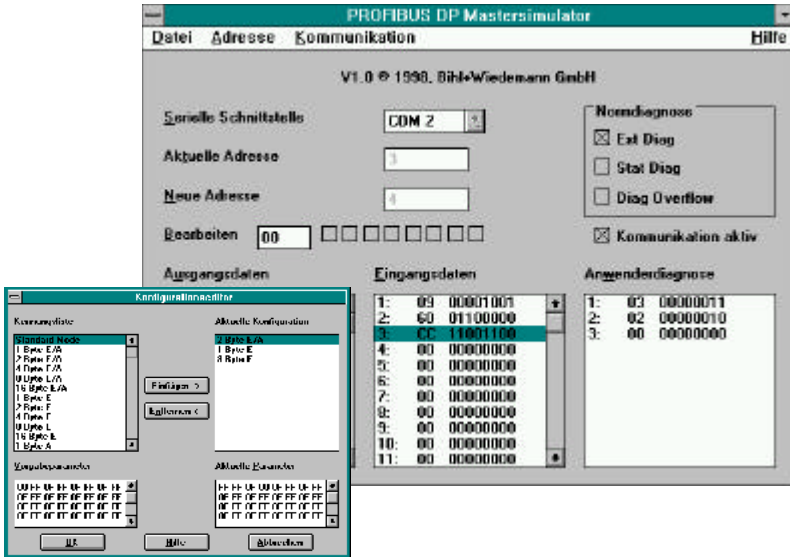

The Profibus DP Mastersimulator is a simple universal tool for data exchange with Profibus slaves of almost all manufacturers via Profibus DP. The Profibus DP Mastersimulator can exchange data with a Profibus slave even without GSD file, without type file and without a Profibus master. Without further inputs or additional files the Profibus Slave can be put into operation with the default I/O width. Input data can be read and output data be written. This is particularly important with time-critical troubleshoot at the Profibus, if e.g. diskettes of several manufacturers are not seizable. Beyond that the Profibus DP Mastersimulator enables also the use of GSD files, of course, as well as the input of special configurations for starting data exchange with Profibus slaves. Addressing of Profibus Slaves - above all the IP67-Module without address switches - is likewise possible. In the scope of supply of the Profibus DP

The scope of supply of the Profibus DP Mastersimulator contains a simple Profibus converter. The Profibus converter is the ideal interface converter between the RS232 interface of the PC and the Profibus. The converter is very compact and needs no additional external power supply. Therefore it is in the best way suitable also for mobile build-up with a laptop or a notebook. The Profibus converter can simply be connected between the Profibus slave and the RS232 interface cable.

10 Displays of the Figure Display

In the basic state of the configuration mode, the display shows one after the other the addresses of all detected slaves at a rate of two per second. A blank display means that the *LDS* is empty, i.e. no slaves were detected.

In the basic state of the protected operating mode, the display is either blank or displays the address of a faulty assignment (see chapter 6.3.2).

During manual address programming, the slave address display has a different meaning, of course (see chapter 6.4 and 6.5).

All displayed numbers that are bigger than 31 and therefore can not be interpreted as a slave address are status or error messages of the master. They have the following meanings:

40	The AS-i master is in off-line phase.
41	The AS-i master is in detection phase.
42	The AS-i master is in activation phase.
43	The AS-i master starts normal operating mode.
70	Hardware error: The AS-i master's EEPROM cannot be written to.
72	Hardware error: The PIC processor does not respond.
73	Hardware error: The PIC processor does not respond.
74	Checksum error in the EEPROM.
75	Error in the external RAM.
76	Error in the external RAM.
80	Error while attempting to exit the configuration mode: A slave with address zero exists.
81	General error while changing a slave address.
82	The front panel operation is blocked. Until the next power-up of the AS-i master the accessing to the device from the host via the interface.
83	Program reset of the AS-i Control programm: The AS-i Control programm is just readed out of EEPROM and copied into the RAM.
88	Display test while starting up the AS-i master
90	Error while changing a slave address in protected operating mode: No slave with address 0 existing.
91	Error while changing slave address: Target address is already occupied.
92	Error while changing slave address: New address could not be set.
93	Error while changing slave address: New address could only be stored volatile in the slave.
94	Error while changing slave address in protected operating mode: Slave has wrong configuration data.
95	Error while changing slave address in protected operating mode: The configuration error caused by one slave too many (instad by missing slave).

11 Appendix: AS-i Slave Lists and Data Telegrams

11.1 AS-i Slave Lists

The AS-i Slave lists LPS, LDS, LAS, LCS, LOS and the configuration error list are built up as follows:

byte	0							1								
bit	0	1	2	3	4	5	6	7	0	1	2	3	4	5	6	7
slave	-	1	2	3	4	5	6	7	8	9	10	11	12	13	14	15

byte	2							3								
bit	0	1	2	3	4	5	6	7	0	1	2	3	4	5	6	7
slave	16	17	18	19	20	21	22	23	24	25	26	27	28	29	30	31

Meaning of the Lists:

LPS List of Projected Slaves

LDS List of Detected Slaves

LAS List of Activated Slaves

LCS List of Corrupted Slaves

List of those slaves, that have caused a short-time configuration error.

LOS List of Off-line Slaves

List of those slaves, with that in case of configuration error the AS-i Master shall switch to the Off-line phase.

configuration error list

A bit in the configuration error list is set, if the concerning bit in the LPS (List of Projected Slaves) differs from the one in the LDS (List of Detected Slaves) or if the projected AS-i configuration data (I/O- and ID-code) of the concerning AS-i slave differ from the detected configuration in the AS-i circuit.

11.2 Execution Control Flags

The execution control flags are transmitted in the diagnosis telegram, if the gateway is operated in the professional mode.

When set, the individual bits have the following meaning:

bit 0:	<i>config_OK</i>	no configuration error
bit 1:	<i>LDS.0</i>	slave with address 0 present
bit 2:	<i>Auto_Address_Assign</i>	automatic programming permitted
bit 3:	<i>Auto_Address_Available</i>	automatic programming available
bit 4:	<i>Configuration_Active</i>	configuration mode active
bit 5:	<i>Normal_Operation_Active</i>	normal operation active
bit 6:		AS-i power failure

Bit 7:	Offline_Ready	off-line mode active
--------	---------------	----------------------

11.3 Structure of the Profibus-DP Data Telegram

11.3.1 Structure of the AS-i data window

byte 0	...	byte N-1
slave 1 AS-i flags	...	slave(K-1) slave(K-2)

with K = number of AS-i slaves + 1 (the AS-i flags are always additionally transmitted)
 N = K/2

Bit allocation by slave 3 and slave 2 in byte 1

byte 1							
bit 7	bit 6	bit 5	bit 4	bit 3	bit 2	bit 1	bit 0
slave 3				slave 2			
D3	D2	D1	D0	D3	D2	D1	D0

Bit allocation by slave (K-1) and slave (K-2) in byte (N-1)

byte (N-1)							
bit 7	bit 6	bit 5	bit 4	bit 3	bit 2	bit 1	bit 0
slave (K-1)				slave (K-2)			
D3	D2	D1	D0	D3	D2	D1	D0

The following AS-i Master flags are transmitted in the I/O field of the DP data telegram in place of the input data of slave 0:

- Bit 0 (Config_OK):
 - 0 = configuration OK
 - 1 = configuration error
- Bit 1 (APF, AS-i power fail):
 - 0 = power supply on AS-i sufficient
 - 1 = power supply on AS-i insufficient
- Bit 2 (Normal_operation_active):
 - 0 = normal operation active
 - 1 = normal operation not active
- Bit 3 (Configuration_active):
 - 0 = protected mode
 - 1 = configuration mode

The following AS-i Master flags are transmitted in the I/O-field of the DP data telegram in place of the output data of slave 0:



Warning

If the AS-i flags shall not be used you have to make sure that these four bits in the I/O-field are set to zero!

issue date: 12.10.1999

Bit 0 (Off-line):

- 0 = The AS-i Master leaves the off-line phase.
- 1 = The AS-i Master is switched to the off-line phase.

Bit 1 (Auto_adress_enable):

- 0 = activates automatic slave addressing
- 1 = inhibits automatic slave addressing

Bit 2 (Configuration mode):

Changing the state of this bit from 0 to 1 puts the device into the configuration mode.

Bit 3 (Protected mode):

Changing the state of this bit from 0 to 1 puts the device into the protected mode.

11.3.2 Data Window for Transmission of AS-i Parameters in Advanced Mode

If in advanced mode in the byte element selection the bit for the transmission of AS-i parameters is set, the DP I/O window is enlarged by 2 bytes. These bytes are added to the window of the input or output data.

Structure of the bytes

DP master call:

byte 0								byte 1							
0	0	0	bit4	bit3	bit2	bit1	bit0	0	0	0	0	bit3	bit2	bit1	bit0
AS-i slave address								answer of the AS-i slave							

DP slave answer: (AS-i/PROFIBUS-Gateway)

byte 0								byte 1							
0	0	0	bit4	bit3	bit2	bit1	bit0	Err	0	0	0	bit3	bit2	bit1	bit0
AS-i slave address								answer of the AS-i slave							

If the bit 7 in the answer byte is set, the corresponding AS-i slave could not be parameterized.

11.3.3 Transmission Window for AS-i Control Code in Advanced Mode

In advanced mode the additional bytes for the transfer of AS-i Control code (control program) are filed behind the I/O data and possible AS-i parameter data in the DP-telegram.

The length of the AS-i Control-code window is specified in the parameterization telegram. It amounts between 5 and 17 bytes.

control byte	address byte 0	address byte 1	data byte 0	...	data byte 13
--------------	----------------	----------------	-------------	-----	--------------

States of the Control byte:

- 00_{hex}: Read AS-i Control flags
- 80_{hex}: Write AS-i Control flags
- 81_{hex}: Download

82_{hex}: Upload

The information about the reading and the writing of the AS-i Control flags is deposited in place of address byte 0. Address byte 1 and all data bytes are set to the value 00_{hex}.

Coding Read AS-i Control flags (00_{hex})

	byte 0					byte n	
DP-request	00 _{hex}	00 _{hex}	00 _{hex}	00 _{hex}	...	00 _{hex}	
DP-response	00 _{hex}	Flags			...		

Coding Write AS-i Control flags (80_{hex})

	byte 0					byte n	
DP-request	80 _{hex}	Flags	00 _{hex}	00 _{hex}	...	00 _{hex}	
DP-response	80 _{hex}	Flags			...		

address byte 0 = flags

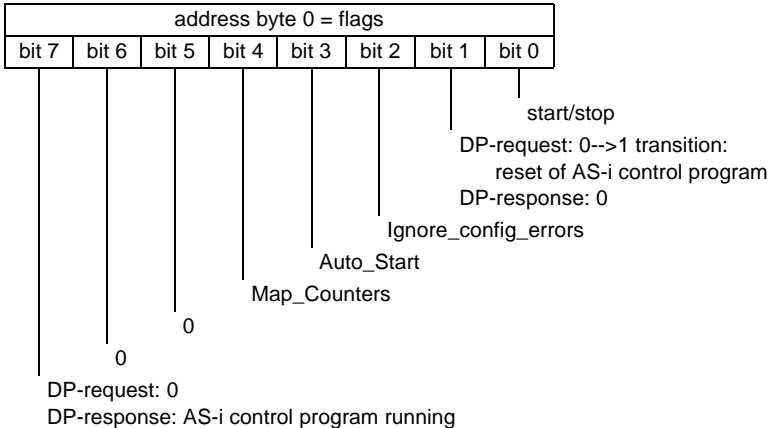

Example: Starting the AS-i Control program in the AS-i/PROFIBUS Gateway:

(Ignore_config_errors = no, Auto_Start = no, Map_Counters = no)

DP-request: 80_{hex} 01_{hex} 00_{hex} 00_{hex} ... 00_{hex}

Coding Download (81_{hex})

	byte 0					byte n	
DP-request	81 _{hex}	B0	B1	D0	...	Dn	
DP-response	81 _{hex}	B0	B1	State	0	0	

state:00hexdownload successful
 state:FFhexerror during download

issue date: 12.10.1999

Coding Upload (82_{hex})

	byte 0				byte n	
DP-request	82_{hex}	B0	B1	0	0	0
DP-response	82_{hex}	B0	B1	D0	...	Dn

B0 = address high byte
 B1 = address low byte
 D0 = data at address B0,B1
 D1 = data at next address

AS-Interface

Appendix: AS-i Slave Lists and Data Telegrams

Issue date 12.10.1999

12 Appendix: The First Commissioning of AS-i



Note

In this chapter an example is given of how to put an AS-i network into operation quickly and easily and without the need for external devices. The addressing of the components connected to the AS-i network can be performed directly on the AS-i master. It is of course more comfortable to do the addressing with a hand-held programming device or a PC. However, it is possible to configure even complex networks using only the AS-i master.

What to do ?	How to go about it?
See to it that the AS-i master is properly supplied with power.	Using AS-i master with power supply "A": connect the AS-i power supply unit to the terminals AS-i + and AS-i - of the master, connect the ground terminal. Using AS-i master with power supply "N": connect the 24 V DC standard power supply with the terminals 24V and 0V of the master, connect the ground terminal. Turn on the power supply.
After the self-test: the LEDs "power", "config err", "U ASI" and "prj mode" are on. The LCD shows "40": the AS-i master is in the off-line phase. Shortly after that a "41" will be displayed: the AS-i master stays in the detection phase.	
Switch the device to the projecting mode, if the yellow LED does not light up.	Press the "mode"-button for approx. five seconds.
The yellow LED "prj mode" lights up. The device is now in projecting mode.	
Add a slave with the address 0 to the AS-i line.	Connect the slave's terminals with the terminals AS-i + / - of the master.
The green LED "ASI active" lights up. The LCD shows "0". This means the AS-i master has detected the slave.	
Change the slave address to address 1.	Select address 1 by pressing the "set" button shortly, if necessary repeatedly. When a "1" appears on the display press the "set" button for approx. five seconds until the display blinks. Press again shortly the "set" button to assign the new address to the slave.
The AS-i master detects the slave with address 1 and displays "1".	
Connect another slave with address 0 to the AS-i line and allocate the address 2 to it.	Connect the slave to the AS-i line. The addressing is the same as for the previous slave.
The addresses of all slaves detected are now displayed sequentially.	

AS-Interface

Appendix: The First Commissioning of AS-i

What to do ?	How to go about it?
Change to the protected operating mode and store the AS-i configuration.	Leave the configuration mode by pressing the "mode" button for at least five seconds until the "prj mode" LED goes out.
<p>The configuration of the master is now finished. If the AS-i Master is a gateway, the hierarchically higher fieldbus system can be put into operation now.</p> <p>The gateway stays in the off-line phase (the display shows "40"), the LED "config err" lights up), until the hierarchically higher fieldbus system operates properly.</p>	

13 Appendix: Putting Profibus into Operation with a Siemens S5

This chapter shows exemplarily the putting into operation of an AS-i/PROFIBUS Gateway on Profibus for the PLC Simatic S5 135 of Siemens with the Profibus master card IM 308 C. The configuration software used is the Siemens COM PROFIBUS 3.0 (German version).

13.1 Putting into Operation in Easy Mode

1. Copy the GSD-file "bwes1742.gsd" (or all GSD-files) from the diskette "AS-i/PROFIBUS Gateway IBM PC Software" from the directory A:\GSD to the directory \GSD of the software COM PROFIBUS 3.0.
2. Start the configuration software COM PROFIBUS 3.0
3. Execute the command "File | Scan GSD-Files".
4. Execute the command "File | New".

The dialog box "Master & Host Selection" appears.

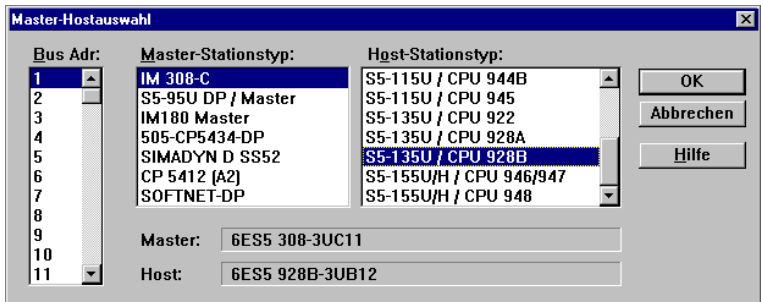

Select your Profibus master.

5. With the command "Configure | Master Parameters..." you can select the baudrate and other bus parameters.

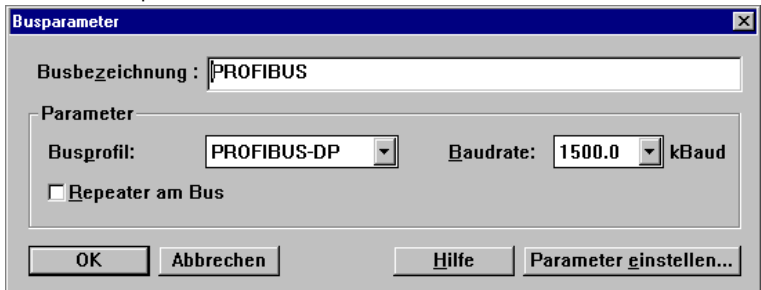

Appendix: Putting Profibus into Operation with a Siemens S5

6. In the window "DP Master System" there is a ledge with several Profibus slaves. Click on AS-i and drag the icon to the Profibus in the window above.

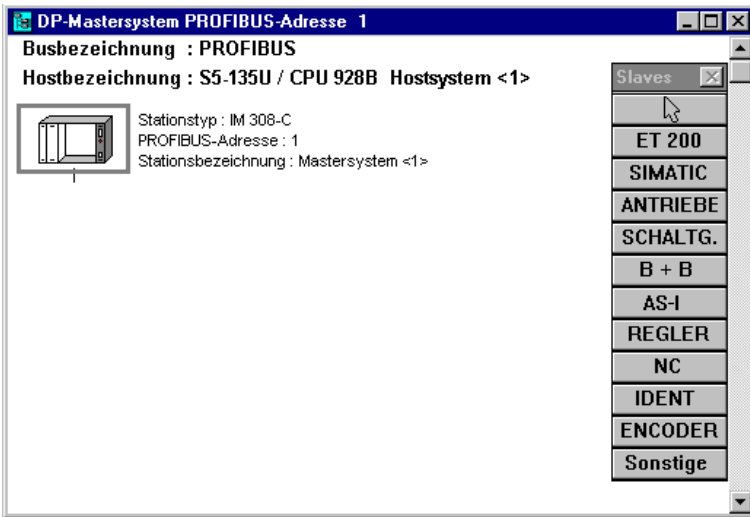

7. After a second mouse click the dialogbox for the selection of the Profibus station address appears:



AS-i/PROFIBUS Gateway

Appendix: Putting Profibus into Operation with a Siemens S5

8. and afterwards the dialogbox for the selection of the device type (Slave Parameters):

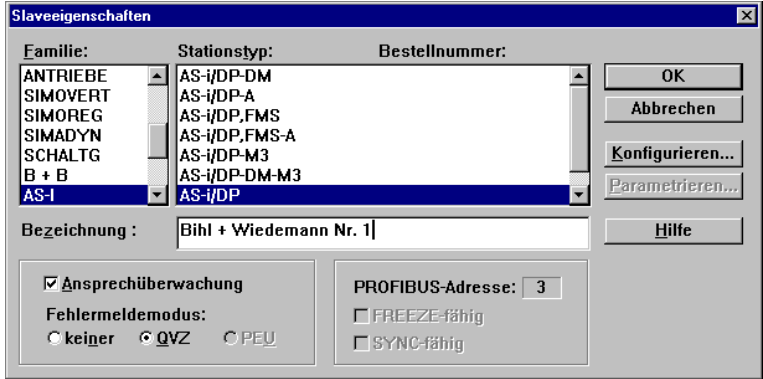

Choose „AS-i /DP“ as station type. This name stands for the GSD-file with the settings for the easy mode.

9. Afterwards, your Profibus system looks like as follows:



10. Select the Profibus slave. With the command "Configure | Slave Parameters... | Configure..." you get to the dialogbox "Configure".

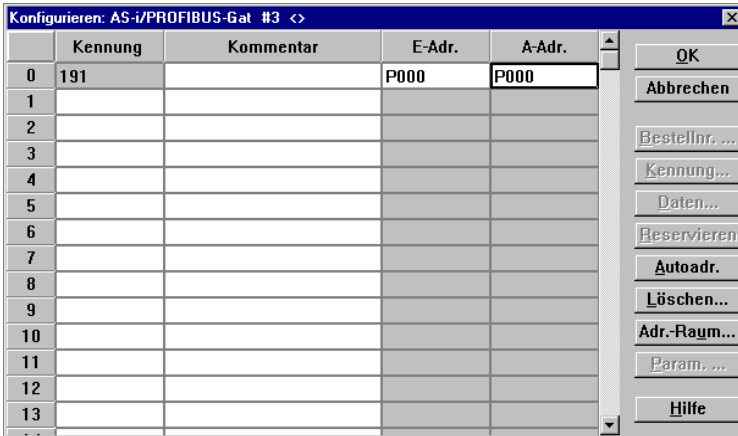

The fields "I Addr." and "O Addr." hold the start addresses for the AS-i data. The easiest way to set the addresses is with "Auto Addr.". From these addresses 16 bytes of AS-i data each are mapped to the address space of your PLC.

This AS-i data can be processed with your user program by means of load and transfer operations.

11. After closing this dialogbox save your project with the command "File | Save".
12. The last step is exporting the data to a memory card with the command "File | Export | Memory Card..."

13.2 Putting into Operation in Professional Mode

The AS-i/PROFIBUS-DP Gateway shall now be put into operation for the following AS-i circuit:

3 AS-i slaves, all slaves AS-i ID 0

Slave 1: 4 inputs

Slave 2: 4 outputs

Slave 3: 2 inputs, 2 outputs

The transmission of AS-i Control user memory shall be possible:

from user memory byte 0 read 21 user memory bytes

don't write user memory bytes

1. Copy the GSD file "bwps1742.gsd" (or all GSD files) from the diskette "AS-i/PROFIBUS-Gateway IBM PC Software" from the directory A:\GSD to the directory \GSD of the software COM PROFIBUS 3.0.
2. Start the configuration software COM PROFIBUS 3.0
3. Execute the command "File | Scan GSD-Files".

4. Execute the command "File | New".

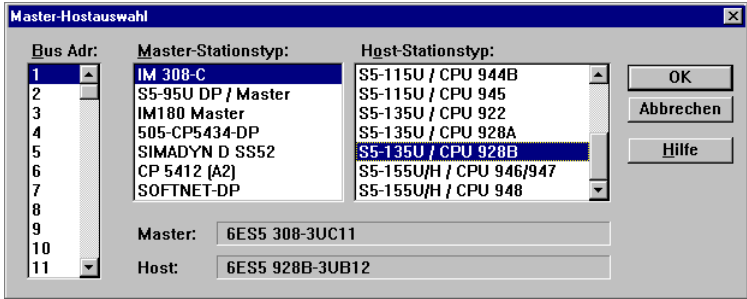

The dialogbox "Master & Host Selection" appears.
 Select your Profibus master.

5. With the command "Configure | Master Parameters..." you can select the baudrate and other bus parameters.

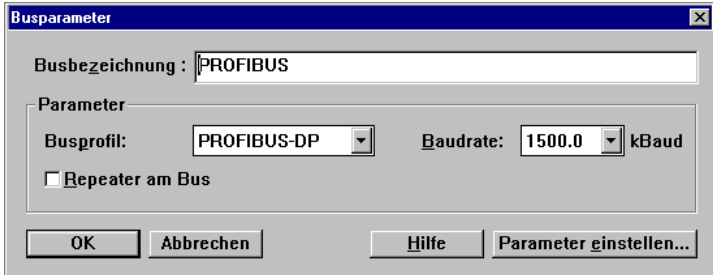

6. In the window "DP Master System" there is a ledge with several Profibus slaves.

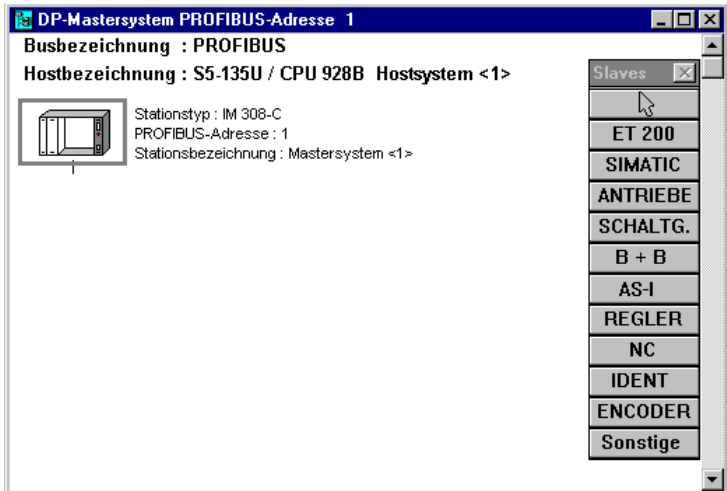

Appendix: Putting Profibus into Operation with a Siemens S5

Click on AS-i and drag the icon to the Profibus in the window above.

7. After a second mouse click the dialogbox for the selection of the Profibus station address appears:



8. and afterwards the dialogbox for the selection of the device type (Slave Parameters):

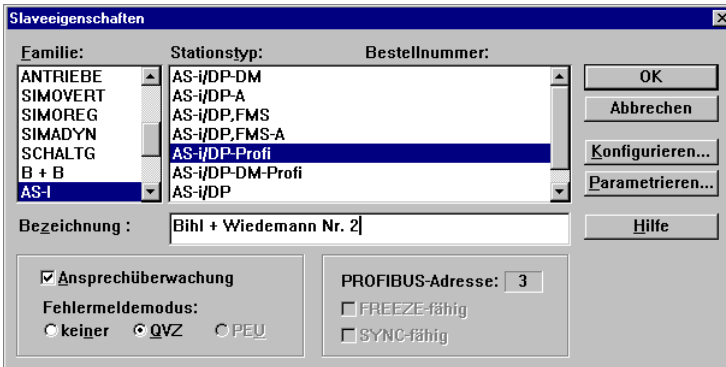

Choose "AS-i /DP-Profi" as station type. This name stands for the GSD-file with the settings for the professional mode.

AS-i/PROFIBUS Gateway

Appendix: Putting Profibus into Operation with a Siemens S5

9. Afterwards, your Profibus system looks like as follows:

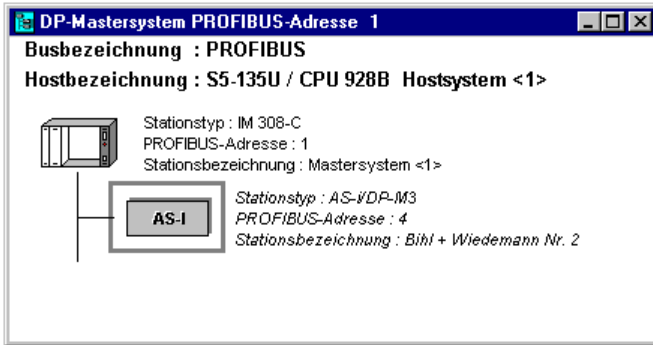

10. Select the Profibus slave. With the command "Configure | Slave Parameters... | Configure..." you get to the dialogbox "Configure".



11. Choose as first identification from the dialogbox "Order No." an identification for the largest used AS-i slave address:



Appendix: Putting Profibus into Operation with a Siemens S5

12. Choose as second identification from the dialogbox "Order No." the identification "Managementkanal 3 Byte E/A".
13. Choose as third identification from the dialogbox "ID" the identification the appropriate length for user flag bytes.

14. If the AS-i Control user memory field is bigger than 16 bytes the identification has to be put together out of several identification bytes. Therefore a fourth identification with the length 5 bytes has to be added, to transmit a whole user memory field of 21 bytes.
15. The dialogbox "Configure" now looks like as follows:

	Kennung	Bestellnummer	Kommentar	E-Adr.	A-Adr.
0	16DX	2 Byte E/A (2-3 Slaves)		P000	P000
1	24DX	Managementkanal 3 Byte E/A		P002	P002
2	031		Merkerkennung 1	P005	
3	020		Merkerkennung 2	P021	
4					
5					
6					
7					
8					
9					
10					
11					
12					
13					

The fields "I Addr." and "O Addr." hold the start addresses for the AS-i data, the management channel and the user memory bytes. The easiest way to set the addresses is with "Auto Addr."

AS-i/PROFIBUS Gateway

Appendix: Putting Profibus into Operation with a Siemens S5

16. Select the Profibus slave. With the command "Configure | Slave parameters... | Parameterize..." you get to the dialogbox "Parameterize".

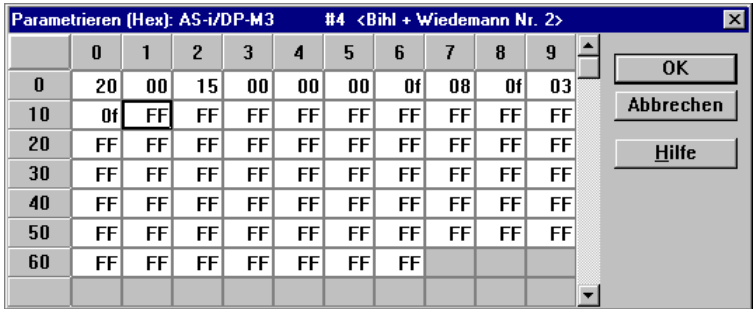

Edit the dialogbox as shown above, to set the user memory fields and to state the AS-i configuration in the parameterization telegram.

17. After closing this dialogbox save your project with the command "File | Save".
18. The last step is exporting the data to a memory card with the command "File | Export | Memory Card..."

With regard to the supply of products, the current issue of the following document is applicable:
The General Terms of Delivery for Products and Services of the Electrical Industry, as published by
the Central Association of the 'Elektrotechnik und Elektroindustrie (ZVEI) e.V.',
including the supplementary clause "Extended reservation of title"

We at Pepperl+Fuchs recognise a duty to make a contribution to the future.
For this reason, this printed matter is produced on paper bleached without the use of chlorine.

One Company, Two Divisions.



Factory Automation Division

Product Range

- Digital and analogue sensors
- in different technologies
 - Inductive and capacitive sensors
 - Magnetic sensors
 - Ultrasonic sensors
 - Photoelectric sensors
- Incremental and absolute rotary encoders
- Counters and control equipment
- Identification Systems
- AS-Interface

Areas of Application

- Machine engineering
- Conveyor or transport
- Packaging and bottling
- Automotive industry

Service Area

Worldwide sales, customer service and consultation via competent and reliable Pepperl+Fuchs associates ensure that you can contact us wherever or whenever you need us. We have subsidiaries worldwide for your convenience.

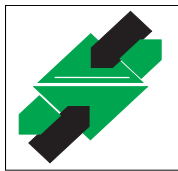

Process Automation Division

Product Range

- Signal conditioners
- Intrinsically safe interface modules
- Remote Process Interface (RPI)
- Intrinsically safe field bus solutions
- Level control sensors
- Process measuring and control systems engineering at the interface level
- Intrinsic safety training

Areas of Application

- Chemical industry
- Industrial and community sewage
- Oil, gas and petrochemical industry
- PLC and process control systems
- Engineering companies for process systems

The Pepperl+Fuchs Group

USA Headquarters

Pepperl+Fuchs Inc. • 1600 Enterprise Parkway
Twinsburg, Ohio 44087 • Cleveland-USA
Tel. (330) 4 25 35 55 • Fax (330) 4 25 93 85
e-mail: sales@us.pepperl-fuchs.com

Asia Pacific Headquarters

Pepperl+Fuchs Pte Ltd. • P+F Building
18 Ayer Rajah Crescent • Singapore 139942
Tel. (65) 7 79 90 91 • Fax (65) 8 73 16 37
e-mail: sales@sg.pepperl-fuchs.com

Worldwide Headquarters

Pepperl+Fuchs GmbH • Königsberger Allee 87
68307 Mannheim • Germany
Tel. +49 621 7 76-0 • Fax +49 621 7 76-10 00
<http://www.pepperl-fuchs.com>
e-mail: fa-info@de.pepperl-fuchs.com

