

MANUAL

**IPT\*-FP with U-P6-B5-V**  
Read/write station with  
INTERBUS interface

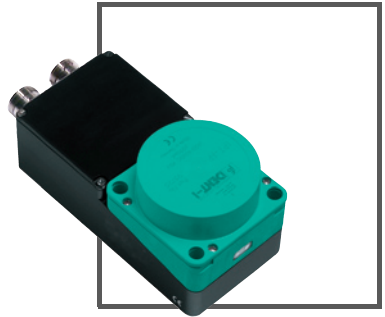

CE

<b>1</b>	<b>Introduction.....</b>	<b>4</b>
<b>2</b>	<b>Declaration of conformity .....</b>	<b>5</b>
2.1	CE conformity .....	5
<b>3</b>	<b>Safety .....</b>	<b>6</b>
3.1	Symbols relevant to safety .....	6
3.2	Intended use.....	6
3.3	General safety instructions.....	6
3.4	Operational reliability and monitoring .....	7
<b>4</b>	<b>Product description.....</b>	<b>8</b>
4.1	Product family .....	9
4.1.1	Code/data carrier .....	9
4.2	Range of application .....	10
4.3	Delivery package.....	10
4.4	Device characteristics .....	10
4.5	Display and controls .....	11
4.6	Diagnostic LEDs .....	11
4.7	Interfaces and connections .....	12
<b>5</b>	<b>Installation.....</b>	<b>13</b>
5.1	Storage and transport .....	13
5.2	Unpacking .....	13
5.3	EMC screening.....	13
5.4	Device connection .....	14
5.4.1	Voltage supply .....	14
5.4.2	Earth connection.....	15
5.4.3	Ring termination.....	15
5.4.4	Cable lengths.....	16
5.4.5	Cable .....	16
5.4.6	Transfer rate changeover .....	16

<b>6</b>	<b>Commissioning .....</b>	<b>17</b>
6.1	Installation check .....	17
6.2	Preliminary considerations .....	18
6.3	Self test .....	18
<b>7</b>	<b>Operation on the INTERBUS.....</b>	<b>19</b>
7.1	General information on INTERBUS.....	19
7.2	Outline of the commands and data on the INTERBUS .....	19
7.3	General command information .....	19
7.3.1	Software information .....	19
7.3.2	Command overview.....	21
7.4	System commands.....	23
7.5	Read/write commands .....	26
7.5.1	Read data .....	26
7.5.2	Write data .....	30
7.6	Read only code .....	34
7.7	Special command modes .....	38
7.7.1	IPC03 configuration .....	38
7.7.2	Password mode with IPC03 .....	48
7.7.3	Write fixed code IPC10 .....	51
7.8	Legend.....	55
7.9	Error/Status messages .....	56
<b>8</b>	<b>Technical specifications .....</b>	<b>57</b>
8.1	Read/write station IPT*-FP.....	57
8.2	Read/write distances IPT*-FP .....	58
8.3	U-P6-B5-V lower section.....	59

# 1 Introduction

## Congratulations

You have chosen a device manufactured by Pepperl+Fuchs. Pepperl+Fuchs develops, produces and distributes electronic sensors and interface modules for the market of automation technology on a worldwide scale.

Before you install this device and put it into operation, please read the operating instructions thoroughly. The instructions and notes contained in this operating manual will guide you step-by-step through the installation and commissioning to ensure the trouble-free usage of this product. This is useful to you, because with this you:

- support the safe operation of the device
- can utilize the device's entire range of functions
- reduce faulty operation and the associated errors
- reduce costs from downtime and incidental repairs
- increase the effectiveness and operating efficiency of your plant.

Store this operating manual somewhere safe in order to have it available for future work on the device.

Directly after opening the packaging, please ensure that the device is intact and that the package is complete.

## Symbols used

The following symbols are used in this manual:



### **Note!**

This symbol draws your attention to important information.



### Handling instructions

You will find handling instructions beside this symbol

## Contact

If you have any questions about the device, its functions, or accessories, please contact us at:

Pepperl+Fuchs GmbH  
Lilienthalstraße 200  
68307 Mannheim  
Telephone: +49 621 776-4411  
Fax: +49 621 776-274411  
E-Mail: fa-info@pepperl-fuchs.com

## 2 Declaration of conformity

### 2.1 CE conformity

This product was developed and manufactured under observance of the applicable European standards and guidelines.



**Note!**

A declaration of conformity can be requested from the manufacturer.

## 3 Safety

### 3.1 Symbols relevant to safety



**Danger!**

This symbol indicates a warning about a possible danger.

In the event the warning is ignored, the consequences may range from personal injury to death.



**Warning!**

This symbol indicates a warning about a possible fault or danger.

In the event the warning is ignored, the consequences may course personal injury or heaviest property damage.



**Caution!**

This symbol warns of a possible fault.

Failure to observe the instructions given in this warning may result in the devices and any connected facilities or systems develop a fault or fail completely.

### 3.2 Intended use

Together, the devices IPT\*-FP and U-P6-B5-V of the inductive identification system IDENT-I System P comprise a read/write station..

Always operate the device as described in these instructions to ensure that the device and connected systems function correctly. The protection of operating personnel and plant is only guaranteed if the device is operated in accordance with its intended use.

### 3.3 General safety instructions

Only instructed specialist staff may operate the device in accordance with the operating manual.

Independent interventions and separate modifications are dangerous and will void the warranty and exclude the manufacturer from any liability. If serious faults occur, stop using the device. Secure the device against inadvertent operation. In the event of repairs, send the device to Pepperl+Fuchs.

The connection of the device and maintenance work when live may only be carried out by a qualified electrical specialist.

The operating company bears responsibility for observing locally applicable safety regulations.

Store the not used device in the original packaging. This offers the device optimal protection against impact and moisture.



**Note!**

Electronic waste is hazardous waste. Observe local disposal regulations.

### 3.4 Operational reliability and monitoring

The devices IPT\*-FP and U-P6-B5-V of the inductive identification system IDENT-I system P operate on a microprocessor level. Device status is reported via LEDs on the front side on the IPT\*-FP read station and in the U-P6-B5-V lower section terminal compartment.

In addition, the INTERBUS functionality can be tested by querying the status information or via specific commands to test the device. Device error or the failure of a read/write station, for example, can be recognized and reported by the INTERBUS master in this way.

## 4 Product description

The brand name IDENT-I System P represents a complete identification system. The read/write station consists of the read/write head IPT\*-FP (standard version: IPT1-FP) and the lower section U-P6-B5-V with INTERBUS interface. With the use of 125 kHz technology, the system is extensively open for the implementation of other components.



205842.2009-03



## 4.1 Product family

The inductive identification system IDENT-I system P from Pepperl+Fuchs offers various possible combinations of individual components.

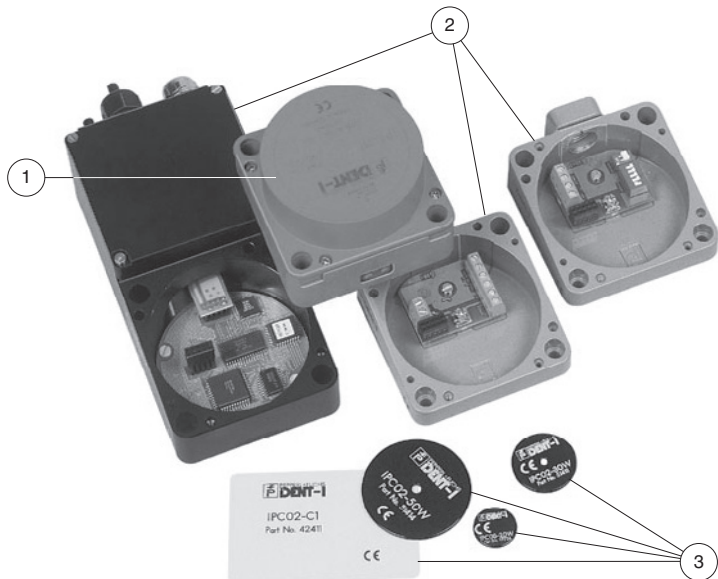

- 1 Read/write station
- 2 Lower sections
- 3 Code/data carrier



**Note!**

Detailed information on the components of the identification system IDENT-I system P can be found in the sensor systems 1 catalog.

### 4.1.1 Code/data carrier

A wide assortment of designs is available for the inductive 125 kHz code and data carriers. Data carriers are available for temperatures up to 300 °C (max. 5 min) in chemical-resistant housings for installation in metal and in protection class IP68/IP69K. IPC02-... code carriers offer 40-bit fixcode. IPC03-... data carriers have 928 bits of freely programmable memory and a non-variable fixcode of 32 bits. The storage area of the IPC03-... can be protected against unauthorized read and write. 40-bit fixcodes that can be freely determined can be generated with IPC11-... code carriers. These fixcodes can be generated one time permanently or they can be modifiable.

## 4.2 Range of application

The system is suited for the following applications:

- Automation
- Material flow control in production
- Acquisition of operating data
- Access control
- Identification of e.g. storage vessels, pallets, work piece carriers, refuse containers, tanks, containers, etc.

## 4.3 Delivery package

IPT\*-FP contains:

- 1 Read/write head
- CD with documentation (incl. this manual)

U-P6-B5-V<sup>1</sup> contains:

- Lower section
- 1 cover
- 2 ring terminals
- 1 earthing screw
- 1 serrated lock washer
- 1 sticker

<sup>1</sup> The lower section must be ordered separately.

## 4.4 Device characteristics

The lower section U-P6-B5-V connects the read/write station with the INTERBUS installation remote bus.

- Supply voltage with galvanic isolation
- Bus interfaces with functional isolation accordant with EN 50178.
- Installation field bus connection via M23 round connector
- Addressing by means of physical position of the station in the system
- Display LEDs (on the front of the read/write station IPT\*-FP)
- Diagnostic LEDs
- The lower section operates as a passive node (Slave). It is therefore restricted to use on the cyclically read process data channel. The device assigns 5 words to each 16 bits (10 bytes). The acyclically read parameter channel of the INTERBUS protocol is not assigned.

#### 4.5 Display and controls

The following displays and controls are located on the read/write head.

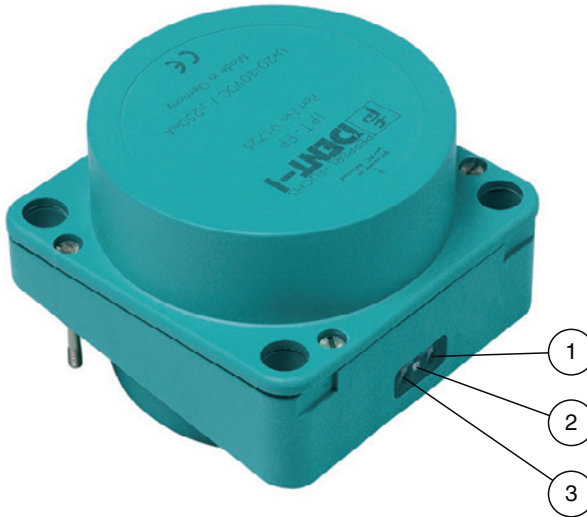

LED display

- 1 Bus error - red
- 2 IPC recognized - yellow,  
command executed successfully (approx. 1 second)
- 3 Power on - green

#### 4.6 Diagnostic LEDs

The following diagnostic LEDs are located in the terminal compartment of the lower section:

LED	Color	Meaning
US	green	"Power on"
RC	green	"Remote Check"
BA	green	"Bus Active"
RD	yellow	"Remotebus Disabled"

## 4.7 Interfaces and connections

The following interfaces and connections are located on the lower section U-P6-B5-V:

incoming interface

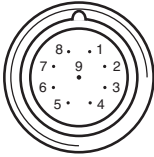

connector

- 1 DO1
- 2 /DO1
- 3 DI1
- 4 /DI1
- 5 GND
- 6 PE
- 7 +24 V
- 8 0 V
- 9

outgoing interface

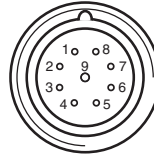

socket

- 1 DO2
- 2 /DO2
- 3 DI2
- 4 /DI2
- 5 GND
- 6 PE
- 7 +24 V
- 8 0 V
- 9 /RBST

## 5 Installation

### 5.1 Storage and transport

For storage and transport purposes, package the unit using shockproof packaging material and protect it against moisture. The best method of protection is to package the unit using the original packaging. Furthermore, ensure that the ambient conditions are within permissible range.

### 5.2 Unpacking

Check the product for damages while unpacking. In the event of damage to the product, inform the post office or parcel service and notify the supplier.

Check the package contents with your purchase order and the shipping documents for:

- Delivery quantity
- Device type and version in accordance with the type plate
- Accessories
- Manual/manuals

Retain the original packaging in case the device must be stored or shipped again at a later date.

Should you have any questions, please direct them to Pepperl+Fuchs.

### 5.3 EMC screening

The screening of cables provides for the discharge of electromagnetic interference. When screening a cable, both sides of the screen must be connected to the earth with low resistance and low inductance.

The thread of the M23 round connector is connected conductively to the lower section housing. For correct EMC screening, cable should be used, whose screen is connected to the nut of the plug connector.

5.4 Device connection

5.4.1 Voltage supply

The electrical connection of the lower section is made via M23 round connector. The assignment of the individual pins is shown in the connection diagram.

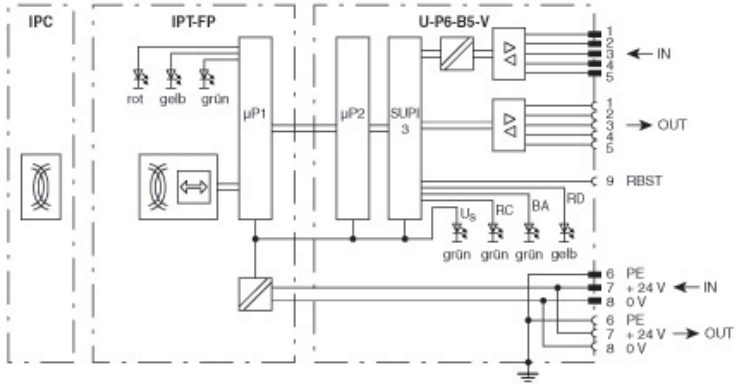

incoming interface

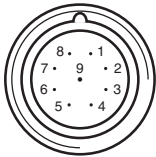

connector

- 1 DO1
- 2 /DO1
- 3 DI1
- 4 /DI1
- 5 GND
- 6 PE
- 7 +24 V
- 8 0 V
- 9

outgoing interface

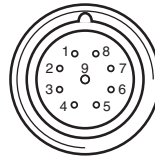

socket

- 1 DO2
- 2 /DO2
- 3 DI2
- 4 /DI2
- 5 GND
- 6 PE
- 7 +24 V
- 8 0 V
- 9 /RBST

### 5.4.2 Earth connection

The internal PE connection of the lower section is conductively connected with the housing. However, from the point of view of screening, connection to the outside of the housing is preferable.

The external earth connection of the lower section is located lower left, adjacent to the round connectors. The PE conductor is screwed to the housing with a crimp connector. In order to guarantee safe earthing, the serrated washer must be mounted between the crimp connector and the housing.

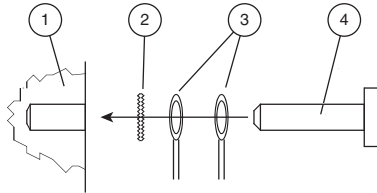

- 1 Housing
- 2 Serrated lock washer
- 3 Crimp connector
- 4 Lock screw

A cross-section of at least 4 mm<sup>2</sup> is recommended for the PE conductor lead.



**Note!**

The "CMD" manufacturer-independent program is available for planning, commissioning and diagnosing INTERBUS networks.

Details of this program and information on the general theme of INTERBUS are available from:

INTERBUS-Club  
Postfach 11 08  
D-32817 Blomberg  
Tel: +49 52 35/ 34 21 00  
Fax: +49 52 35/ 34 12 34

### 5.4.3 Ring termination

A characteristic of the INTERBUS system is its physical ring structure. Each connected device lies in the bus between two other stations. If this is not the case, for example, at the end of a branch with a bus terminal, then the ring line must be closed.

The ring line in the lower section U-P6-B5-V is automatically closed. If the network of the installation remote bus is extended at the outgoing connection point using a suitable cable, the 0 V potential is laid to the "RBST" input, so that the ring line is automatically opened for the following devices.

### 5.4.4 Cable lengths

Depending on the type of cable used and the magnitude of the external interference, the total expansion of an INTERBUS installation remote bus can be up to 50 m. The number of devices connected to the bus is limited to 512.

### 5.4.5 Cable

The following INTERBUS installation remote bus cables should be used:

Parameter	Standard	Highly flexible	Suitable for laying underground
Conductor cross-section	3 x 2 x 0,22 mm <sup>2</sup> + 3 x 1 mm <sup>2</sup>	3 x 2 x 0,25 mm <sup>2</sup> + 3 x 1 mm <sup>2</sup>	3 x 2 x 0,22 mm <sup>2</sup> + 3 x 1 mm <sup>2</sup>

The best possible EMC interference immunity can only be achieved using screened cables.

### 5.4.6 Transfer rate changeover

An internal slide switch enables the transfer rate to be adjusted to match that of the bus. This allows the two values of 500 kbit/s and 2 Mbit/s to be set.

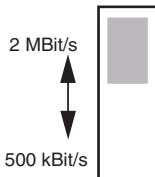

The status is preset at 2 Mbit/s on delivery.

205842-2009-03



## 6 Commissioning



**Warning!**

Before commissioning, ensure that the plant is not in danger relating to device malfunction, e.g. from uncontrollable triggered processes.

### 6.1 Installation check



**Caution!**

Before commissioning, check once again that the connections are correct.

Before commissioning, familiarize yourself with the system of communication between your INTERBUS and the read/write station. Commissioning requires accurate knowledge of INTERBUS and the programming of your master device.

incoming interface

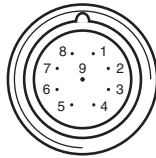

connector

- 1 DO1
- 2 /DO1
- 3 DI1
- 4 /DI1
- 5 GND
- 6 PE
- 7 +24 V
- 8 0 V
- 9

outgoing interface

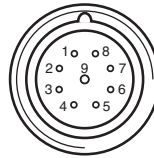

socket

- 1 DO2
- 2 /DO2
- 3 DI2
- 4 /DI2
- 5 GND
- 6 PE
- 7 +24 V
- 8 0 V
- 9 /RBST

After connecting the supply voltage the green LED on the read station and the green "US" LED on the lower section must light. Configure the read/write station with the described system commands. "Autodetect" is set as the data carrier type.

The transfer speed on the INTERBUS is 500 kbit/s or 2 Mbit/s.

## 6.2 Preliminary considerations

Due to the complexity of field bus programming with the INTERBUS it is very difficult to make generally valid statements about commissioning.

A very important aspect of the operation of an inductive identification system with the lower section on the INTERBUS is the time response of the overall system. The question, "How long after the positioning of a data carrier in front of a read/write station will the read data be available in my computer?" is answered with the aid of knowledge of the INTERBUS protocol structure and the following formula:

$$t_{\bar{u}} = [182 + 1,5 \times m] \times t_{\text{Bit}} + t_{\text{sw}}$$

$t_{\bar{u}}$  = Transfer time

$m$  = Number of remote bus stations installed

$t_{\text{Bit}}$  = Bit duration

$t_{\text{Bit}} = 2 \mu\text{s}$  corresponding to 500 kBit/s or

$t_{\text{Bit}} = 0.5 \mu\text{s}$  corresponding to 2 MBit/s

$t_{\text{sw}}$  = Software run time

$t_{\text{sw}} = 200 \mu\text{s}$

On large projects, or if you have little experience of programming an INTERBUS system, you should, in any case, construct a laboratory set up of your application and test the data transfer to the INTERBUS master before installing the system in the plant.



### **Note!**

The "CMD" manufacturer-independent program is available for planning, commissioning and diagnosing INTERBUS networks.

Details of this program and information on the general theme of INTERBUS are available from:

INTERBUS-Club  
Postfach 11 08  
D-32817 Blomberg  
Tel: +49 52 35/ 34 21 00  
Fax: +49 52 35/ 34 12 34

## 6.3 Self test

When the power supply is switched on the device executes a self test in its internal memory. If the error "RAM defect" or "ROM defect" occurs, the communication is not activated. If no error occurs, then the connection to the INTERBUS master is established automatically.

## 7 Operation on the INTERBUS

### 7.1 General information on INTERBUS

The INTERBUS is a standardized field bus, which enables data exchange between PLCs, PCs, operating and observation devices and also sensors and actuators.

For detailed information, reference should be made to the INTERBUS standard DIN 19258 and to the current literature on the subject.



**Note!**

The INTERBUS Club publishes informational brochures and an INTERBUS product catalog.

### 7.2 Outline of the commands and data on the INTERBUS

The lower section assigns 5 words to each 16 bits (10 bytes) in the framework protocol of the INTERBUS in both communication directions. It is restricted in this to the cyclic transfer of the process data channel. This means:

- Even the instructions for the adjustment of the device are updated on every cycle.
- The parameter channel of the INTERBUS is not used.
- The control interface unit is designed as a remote bus station. The ID code is 03.

### 7.3 General command information

#### 7.3.1 Software information

A command consists of the command code, a specified number of parameters, the toggle flag and the data relating to the command. The command is entered in the output data field of the master.

A response is read from the input data field of the master and consists of the echo of the command code, a parameter, the toggle flag, the status, an execution counter and the read data.

A number of commands do not use all the parameter and data fields. These unused data fields are then ignored by the device. The input and output fields are constructed as follows:

Output data field:

Byte 0	Command code
Byte 1	Parameter/Toggle flag
Byte 2	Parameter
Byte 3	Parameter
Byte 4	Write data
...	...
Byte N (defined by module selection)	Write data

Input data field:

Byte 0	Command code (Echo)
Byte 1	Parameter/Toggle flag (Echo)
Byte 2	Status
Byte 3	Execution counter
Byte 4	Read data
...	...
Byte N (defined by module selection)	Read data

In order to send a new command to the device, the INTERBUS master must write a command in the output data field. The new command is executed when the data has changed relative to the last read-in. If the same command is to be executed a number of times, the toggle flag must be inverted, so that the device recognizes that a new command has to be processed.

Upon detection of a new command "Status" is set to FFh. In addition, the execution counter is set to 00h and on every further execution of this command it counts up. If the execution counter overruns, it starts again at 00h. An overrun exists when the execution counter reading is equal to 00h and the status is not equal to FFh.

After the processing of commands by the identification system, the "Status" is output in accordance with the Status/Fault signal table (see Section 7.8).

The first two bytes of the response correspond to the first two bytes of the command call-up. Correspondingly, the toggle bit of the response is the same as the toggle bit of the command.

The commands **buffered...** and **enhanced buffered...** are executed repeatedly as long as the commands remain in the output data field. The execution is terminated when a new command is written in the data.

### 7.3.2 Command overview

The commands in the list are described in detail on the following pages.

#### System commands

Command code		Command description	Abbreviation
2d	02h	quit	<b>QU</b>
4d	04h	change tag	<b>CT</b>
3d	03h	version	<b>VE</b>

#### Standard read/write commands

##### Fixcode

Command code		Command description	Abbreviation
1d	1h	single read fixcode	<b>SF</b>
8d	8h	auto read fixcode	<b>AF</b>
9d	9h	buffered read fixcode	<b>BF</b>
29d	1Dh	enhanced buffered read fixcode	<b>EF</b>

##### Read data

Command code		Command description	Abbreviation
16d	10h	single read words	<b>SR</b>
32d	20h	auto read words	<b>AR</b>
48d	30h	buffered read words	<b>BR</b>
25d	19h	enhanced buffered read words	<b>ER</b>

##### Write data

Command code		Command description	Abbreviation
64d	40h	single write words	<b>SW</b>
80d	50h	auto write words	<b>AW</b>
96d	60h	buffered write words	<b>BW</b>
26d	1Ah	enhanced buffered write words	<b>EW</b>

Special command modes

Password mode with IPC03

Command code		Command description	Abbreviation
24d	18h	password mode	<b>PM</b>
65d	41h	password change	<b>PC</b>
66d	42h	password set	<b>PS</b>

IPC03 configuration

Command code		Command description	Abbreviation
18d	12h	single write configuration	<b>SC</b>
19d	13h	auto write configuration	<b>AC</b>
20d	14h	buffered write configuration	<b>BC</b>
102d	66h	enhanced buffered write configuration	<b>EC</b>
97d	61h	single get configuration	<b>SG</b>
98d	62h	auto get configuration	<b>AG</b>
99d	63h	buffered get configuration	<b>BG</b>
104d	68h	enhanced buffered get configuration	<b>EG</b>

Write fixcode

Commands for the IPC10 and IPC11

Command code		Command description	Abbreviation
31d	1Fh	single write fixcode	<b>SX</b>
100d	64h	auto write fixcode	<b>AX</b>
101d	65h	buffered write fixcode	<b>BX</b>
36d	24h	enhanced buffered write fixcode	<b>EX</b>

## 7.4 System commands

### Quit

Byte	Content	B7	B6	B5	B4	B3	B2	B1	B0
Byte 0	Command code	0	0	0	0	0	0	1	0
Byte 1	Reserved/Toggle bit	-	-	-	-	-	-	-	T
Byte 2	not relevant	-	-	-	-	-	-	-	-
.	.	-	-	-	-	-	-	-	-
.	.	-	-	-	-	-	-	-	-
Byte 9	not relevant	-	-	-	-	-	-	-	-

### Response:

Byte	Content	B7	B6	B5	B4	B3	B2	B1	B0
Byte 0	Command code	0	0	0	0	0	0	1	0
Byte 1	Reserved/Toggle bit	-	-	-	-	-	-	-	T
Byte 2	Status	<Status>							
Byte 3	Execution counter	<ExecCounter>							
Byte 4	not relevant	-	-	-	-	-	-	-	-
.	.	-	-	-	-	-	-	-	-
.	.	-	-	-	-	-	-	-	-
Byte 9	not relevant	-	-	-	-	-	-	-	-

The running buffered, enhanced-buffered or auto command of the specified read/write head is interrupted.

**Change Tag**

Byte	Content	B7	B6	B5	B4	B3	B2	B1	B0
Byte 0	Command code	0	0	0	0	0	1	0	0
Byte 1	Reserved/Toggle bit	-	-	-	-	-	-	-	T
Byte 2	Data carrier type in ASCII	<TagType> (High Byte)							
Byte 3	Data carrier type in ASCII	<TagType> (Low Byte)							
Byte 4	not relevant	-	-	-	-	-	-	-	-
.	.	-	-	-	-	-	-	-	-
.	.	-	-	-	-	-	-	-	-
Byte 9	not relevant	-	-	-	-	-	-	-	-

**Response:**

Byte	Content	B7	B6	B5	B4	B3	B2	B1	B0
Byte 0	Command code	0	0	0	0	0	1	0	0
Byte 1	Reserved/Toggle bit	-	-	-	-	-	-	-	T
Byte 2	Status	<Status>							
Byte 3	Execution counter	<ExecCounter>							
Byte 4	not relevant	-	-	-	-	-	-	-	-
.	.	-	-	-	-	-	-	-	-
.	.	-	-	-	-	-	-	-	-
Byte 9	not relevant	-	-	-	-	-	-	-	-

This command tells the read head which code or data carrier to communicate with. The read head status on delivery is type "00".

The following code and data carriers are currently supported:

TagType		Description	Chip	Access	<WordAddr>	Bits
High Byte	Low Byte					
0	0	Autodetect				
0	2	IPC02	μEM V4001	Fixcode		32
0	3	IPC03	μEM V4050/64	R/W	00...1D	928
1	0	IPC10	Nova	R/W	0	96

With <TagType> = "00", mixed operation of different code and data carriers is possible. Since the read head for the autodetect requires a significantly longer time, only static read and write is practical in this mode.

205842-2/09-03



**Version**

Byte	Content	B7	B6	B5	B4	B3	B2	B1	B0
Byte 0	Command code	0	0	0	0	0	0	1	1
Byte 1	Reserved/Toggle bit	-	-	-	-	-	-	-	T
Byte 2	Parameter	<Parameter>							
Byte 3	not relevant	-	-	-	-	-	-	-	-
.	.	-	-	-	-	-	-	-	-
.	.	-	-	-	-	-	-	-	-
Byte 9	not relevant	-	-	-	-	-	-	-	-

**Response**

Byte	Content	B7	B6	B5	B4	B3	B2	B1	B0
Byte 0	Command code	0	0	0	0	0	0	1	1
Byte 1	Reserved/Toggle bit	-	-	-	-	-	-	-	T
Byte 2	Status	<Status>							
Byte 3	Execution counter	<ExecCounter>							
Byte 4	Data 00 ... FF <sub>n</sub>	<VersionData> section 1							
.	Data 00 ... FF <sub>n</sub>	<VersionData> section ...							
.	.								
Byte 9	Data 00 ... FF <sub>n</sub>	<VersionData> section 6							

This command transfers the software version. The complete software version message cannot be transferred with one command due to its length. The individual parts of the software version message are transferred by repeated execution of the command with the appropriate parameters.

<Parameter>	Meaning <VersionData>	Beispiel
0; > 8	Incorrect parameter, Status "04 <sub>h</sub> " Data = 0	000000
1	Identification system - Type	IPT*-FP
2	Identification system - Part number	095725
3	Identification system - software number	01I040
4	Identification system - software date	170399
5	Bus system - type	U-P6B5
6	Bus system - part number	099100
7	Bus system - software number	01K034
8	Bus system - software date	170399

7.5 Read/write commands

7.5.1 Read data

Single Read Words

Byte	Content	B7	B6	B5	B4	B3	B2	B1	B0
Byte 0	Command code	0	0	0	1	0	0	0	0
Byte 1	Word count/Toggle bit	<WordNum>				-	-	-	T
Byte 2	Word address	<WordAddr> (High Byte)							
Byte 3	Word address	<WordAddr> (Low Byte)							
Byte 4	not relevant	-	-	-	-	-	-	-	-
.	.	-	-	-	-	-	-	-	-
.	.	-	-	-	-	-	-	-	-
Byte 9	not relevant	-	-	-	-	-	-	-	-

**Response:**

Byte	Content	B7	B6	B5	B4	B3	B2	B1	B0
Byte 0	Command code	0	0	0	1	0	0	0	0
Byte 1	Word count/Toggle bit	<WordNum>				-	-	-	T
Byte 2	Status	<Status>							
Byte 3	Execution counter	<ExecCounter>							
Byte 4	ID-Code 00 ... FF <sub>n</sub> <sup>a)</sup>	<Data3>							
Byte 5	ID-Code 00 ... FF <sub>n</sub> <sup>a)</sup>	<Data2>							
Byte 6	ID-Code 00 ... FF <sub>n</sub> <sup>a)</sup>	<Data1>							
Byte 7	ID-Code 00 ... FF <sub>n</sub> <sup>a)</sup>	<Data0>							
Byte 8	not relevant	-	-	-	-	-	-	-	-
Byte 9	not relevant	-	-	-	-	-	-	-	-

One attempt is made to read a 32-bit word (<WordNum> = "0001") from the address <WordAddr>.

**Auto Read Words**

Byte	Content	B7	B6	B5	B4	B3	B2	B1	B0
Byte 0	Command code	0	0	1	0	0	0	0	0
Byte 1	Word count/Toggle bit	<WordNum>				-	-	-	T
Byte 2	Word address	<WordAddr> (High Byte)							
Byte 3	Word address	<WordAddr> (Low Byte)							
Byte 4	not relevant	-	-	-	-	-	-	-	-
.	.	-	-	-	-	-	-	-	-
.	.								
Byte 9	not relevant	-	-	-	-	-	-	-	-

**Response:**

Byte	Content	B7	B6	B5	B4	B3	B2	B1	B0
Byte 0	Command code	0	0	1	0	0	0	0	0
Byte 1	Word count/Toggle bit	<WordNum>				-	-	-	T
Byte 2	Status	<Status>							
Byte 3	Execution counter	<ExecCounter>							
Byte 4	ID-Code 00 ... FF <sub>h</sub> <sup>a)</sup>	<Data3>							
Byte 5	ID-Code 00 ... FF <sub>h</sub> <sup>a)</sup>	<Data2>							
Byte 6	ID-Code 00 ... FF <sub>h</sub> <sup>a)</sup>	<Data1>							
Byte 7	ID-Code 00 ... FF <sub>h</sub> <sup>a)</sup>	<Data0>							
Byte 8	not relevant	-	-	-	-	-	-	-	-
Byte 9	not relevant	-	-	-	-	-	-	-	-

Repeated attempts are made until a 32-bit word (<WordNum> = "0001") is read from the address <WordAddr>.

**Buffered Read Words**

Byte	Content	B7	B6	B5	B4	B3	B2	B1	B0
Byte 0	Command code	0	0	1	1	0	0	0	0
Byte 1	Word count/Toggle bit	<WordNum>				-	-	-	T
Byte 2	Word address	<WordAddr> (High Byte)							
Byte 3	Word address	<WordAddr> (Low Byte)							
Byte 4	not relevant	-	-	-	-	-	-	-	-
.	.	-	-	-	-	-	-	-	-
.	.	-	-	-	-	-	-	-	-
Byte 9	not relevant	-	-	-	-	-	-	-	-

**Response:**

Byte	Content	B7	B6	B5	B4	B3	B2	B1	B0
Byte 0	Command code	0	0	1	1	0	0	0	0
Byte 1	Word count/Toggle bit	<WordNum>				-	-	-	T
Byte 2	Status	<Status>							
Byte 3	Execution counter	<ExecCounter>							
Byte 4	ID-Code 00 ... FF <sub>n</sub> <sup>a)</sup>	<Data3>							
Byte 5	ID-Code 00 ... FF <sub>n</sub> <sup>a)</sup>	<Data2>							
Byte 6	ID-Code 00 ... FF <sub>n</sub> <sup>a)</sup>	<Data1>							
Byte 7	ID-Code 00 ... FF <sub>n</sub> <sup>a)</sup>	<Data0>							
Byte 8	not relevant	-	-	-	-	-	-	-	-
Byte 9	not relevant	-	-	-	-	-	-	-	-

An attempt is made to read a 32-bit word (<WordNum> = "0001") from the address until successful <WordAddr>. Only changed data is transferred via the interface, i.e. when the next data carrier is read, or if previously no data carrier was found in the read range, the new data carrier.

**Enhanced buffered Read Words**

Byte	Content	B7	B6	B5	B4	B3	B2	B1	B0
Byte 0	Command code	0	0	1	1	0	0	0	1
Byte 1	Word count/Toggle bit	<WordNum>				-	-	-	T
Byte 2	Word address	<WordAddr> (High Byte)							
Byte 3	Word address	<WordAddr> (Low Byte)							
Byte 4	not relevant	-	-	-	-	-	-	-	-
.	.	-	-	-	-	-	-	-	-
.	.								
Byte 9	not relevant	-	-	-	-	-	-	-	-

**Response:**

Byte	Content	B7	B6	B5	B4	B3	B2	B1	B0
Byte 0	Command code	0	0	1	1	0	0	0	1
Byte 1	Word count/Toggle bit	<WordNum>				-	-	-	T
Byte 2	Status	<Status>							
Byte 3	Execution counter	<ExecCounter>							
Byte 4	ID-Code 00 ... FF <sub>h</sub> <sup>a)</sup>	<Data3>							
Byte 5	ID-Code 00 ... FF <sub>h</sub> <sup>a)</sup>	<Data2>							
Byte 6	ID-Code 00 ... FF <sub>h</sub> <sup>a)</sup>	<Data1>							
Byte 7	ID-Code 00 ... FF <sub>h</sub> <sup>a)</sup>	<Data0>							
Byte 8	not relevant	-	-	-	-	-	-	-	-
Byte 9	not relevant	-	-	-	-	-	-	-	-

An attempt is made to read a 32-bit word (<WordNum> = "0001") from the address until successful <WordAddr>. Only changed data is transferred via the interface. When a data carrier leaves the read range, the status "05h" is output.

7.5.2 Write data

Single Write Words

Byte	Content	B7	B6	B5	B4	B3	B2	B1	B0
Byte 0	Command code	0	1	0	0	0	0	0	0
Byte 1	Word count/Toggle bit	<WordNum>				-	-	-	T
Byte 2	Word address	<WordAddr> (High Byte)							
Byte 3	Word address	<WordAddr> (Low Byte)							
Byte 4	Data 00 ... FF <sub>h</sub>	<Data 3>							
Byte 5	Data 00 ... FF <sub>h</sub>	<Data 2>							
Byte 6	Data 00 ... FF <sub>h</sub>	<Data 1>							
Byte 7	Data 00 ... FF <sub>h</sub>	<Data 0>							
Byte 8	not relevant	-	-	-	-	-	-	-	-
Byte 9	not relevant	-	-	-	-	-	-	-	-

**Response:**

Byte	Content	B7	B6	B5	B4	B3	B2	B1	B0
Byte 0	Command code	0	1	0	0	0	0	0	0
Byte 1	Word count/Toggle bit	<WordNum>				-	-	-	T
Byte 2	Status	<Status>							
Byte 3	Execution counter	<ExecCounter>							
Byte 4	not relevant	-	-	-	-	-	-	-	-
.	.	-	-	-	-	-	-	-	-
.	.								
Byte 9	not relevant	-	-	-	-	-	-	-	-

One attempt is made to write a 32-bit word (<WordNum> = "0001") from the address <WordAddr>. A maximum of 1 word = 4 bytes can be written.

**Auto Write Words**

Byte	Content	B7	B6	B5	B4	B3	B2	B1	B0
Byte 0	Command code	0	1	0	1	0	0	0	0
Byte 1	Word count/Toggle bit	<WordNum>				-	-	-	T
Byte 2	Word address	<WordAddr> (High Byte)							
Byte 3	Word address	<WordAddr> (Low Byte)							
Byte 4	Data 00 ... FF <sub>h</sub>	<Data 3>							
Byte 5	Data 00 ... FF <sub>h</sub>	<Data 2>							
Byte 6	Data 00 ... FF <sub>h</sub>	<Data 1>							
Byte 7	Data 00 ... FF <sub>h</sub>	<Data 0>							
Byte 8	not relevant	-	-	-	-	-	-	-	-
Byte 9	not relevant	-	-	-	-	-	-	-	-

**Response:**

Byte	Content	B7	B6	B5	B4	B3	B2	B1	B0
Byte 0	Command code	0	1	0	1	0	0	0	0
Byte 1	Word count/Toggle bit	<WordNum>				-	-	-	T
Byte 2	Status	<Status>							
Byte 3	Execution counter	<ExecCounter>							
Byte 4	not relevant	-	-	-	-	-	-	-	-
.	.	-	-	-	-	-	-	-	-
.	.	-	-	-	-	-	-	-	-
Byte 9	not relevant	-	-	-	-	-	-	-	-

Repeated attempts are made until a 32-bit word (<WordNum> = "0001") is written from the address <WordAddr>. A maximum of 1 word = 4 bytes can be written.

**Buffered Write Words**

Byte	Content	B7	B6	B5	B4	B3	B2	B1	B0
Byte 0	Command code	0	1	1	0	0	0	0	0
Byte 1	Word count/Toggle bit	<WordNum>				-	-	-	T
Byte 2	Word address	<WordAddr> (High Byte)							
Byte 3	Word address	<WordAddr> (Low Byte)							
Byte 4	Data 00 ... FF <sub>h</sub>	<Data 3>							
Byte 5	Data 00 ... FF <sub>h</sub>	<Data 2>							
Byte 6	Data 00 ... FF <sub>h</sub>	<Data 1>							
Byte 7	Data 00 ... FF <sub>h</sub>	<Data 0>							
Byte 8	not relevant	-	-	-	-	-	-	-	-
Byte 9	not relevant	-	-	-	-	-	-	-	-

**Response:**

Byte	Content	B7	B6	B5	B4	B3	B2	B1	B0
Byte 0	Command code	0	1	1	0	0	0	0	0
Byte 1	Word count/Toggle bit	<WordNum>				-	-	-	T
Byte 2	Status	<Status>							
Byte 3	Execution counter	<ExecCounter>							
Byte 4	not relevant	-	-	-	-	-	-	-	-
.	.	-	-	-	-	-	-	-	-
.	.	-	-	-	-	-	-	-	-
.	.	-	-	-	-	-	-	-	-
Byte 9	not relevant	-	-	-	-	-	-	-	-

An attempt is now made to write a 32-bit word (<WordNum> = "0001") from the address <WordAddr>. After successfully writing, the response is sent and then continuous reading ensues. Then the same carrier data is read, until the data carrier has left the read/write range or a new data carrier appears in front of the read/write head. The command then starts again with write attempts.

A maximum of 1 word = 4 bytes can be written.



**Enhanced Buffered Write Words**

Byte	Content	B7	B6	B5	B4	B3	B2	B1	B0
Byte 0	Command code	0	0	0	1	1	0	0	1
Byte 1	Word count/Toggle bit	<WordNum>				-	-	-	T
Byte 2	Word address	<WordAddr> (High Byte)							
Byte 3	Word address	<WordAddr> (Low Byte)							
Byte 4	Data 00 ... FF <sub>h</sub>	<Data 3>							
Byte 5	Data 00 ... FF <sub>h</sub>	<Data 2>							
Byte 6	Data 00 ... FF <sub>h</sub>	<Data 1>							
Byte 7	Data 00 ... FF <sub>h</sub>	<Data 0>							
Byte 8	not relevant	-	-	-	-	-	-	-	-
Byte 9	not relevant	-	-	-	-	-	-	-	-

**Response:**

Byte	Content	B7	B6	B5	B4	B3	B2	B1	B0
Byte 0	Command code	0	0	0	1	1	0	0	1
Byte 1	Word count/Toggle bit	<WordNum>				-	-	-	T
Byte 2	Status	<Status>							
Byte 3	Execution counter	<ExecCounter>							
Byte 4	not relevant	-	-	-	-	-	-	-	-
.	.	-	-	-	-	-	-	-	-
.	.	-	-	-	-	-	-	-	-
Byte 9	not relevant	-	-	-	-	-	-	-	-

An attempt is now made to write a 32-bit word (<WordNum> = "0001") from the address <WordAddr> . After successfully writing, the response is sent and then continuous reading ensues. Then the same carrier data is read, until the data carrier has left the read/write range or a new data carrier appears in front of the read/write head. The command then starts again with write attempts. The status "05h" is output if the data carrier leaves the read range.

A maximum of 1 word = 4 bytes can be written.

## 7.6 Read only code

### Single Read Fixcode

Byte	Content	B7	B6	B5	B4	B3	B2	B1	B0
Byte 0	Command code	0	0	0	0	0	0	0	1
Byte 1	Reserved/Toggle bit	-	-	-	-	-	-	-	T
Byte 2	not relevant	-	-	-	-	-	-	-	-
.	.	-	-	-	-	-	-	-	-
.	.	-	-	-	-	-	-	-	-
Byte 9	not relevant	-	-	-	-	-	-	-	-

### Response:

Byte	Content	B7	B6	B5	B4	B3	B2	B1	B0
Byte 0	Command code	0	0	0	0	0	0	1	0
Byte 1	Reserved/Toggle bit	-	-	-	-	-	-	-	T
Byte 2	Status	<Status>							
Byte 3	Execution counter	<ExecCounter>							
Byte 4	ID-Code 00 ... FF <sub>n</sub> <sup>a)</sup>	<ID-Code 4> <sup>a)</sup> / <sub>&lt;ID-Code 3&gt;</sub>							
Byte 5	ID-Code 00 ... FF <sub>n</sub> <sup>a)</sup>	<ID-Code 3> <sup>a)</sup> / <sub>&lt;ID-Code 2&gt;</sub>							
Byte 6	ID-Code 00 ... FF <sub>n</sub> <sup>a)</sup>	<ID-Code 2> <sup>a)</sup> / <sub>&lt;ID-Code 1&gt;</sub>							
Byte 7	ID-Code 00 ... FF <sub>n</sub> <sup>a)</sup>	<ID-Code 1> <sup>a)</sup> / <sub>&lt;ID-Code 0&gt;</sub>							
Byte 8	ID-Code 00 ... FF <sub>n</sub> <sup>a)</sup>	<ID-Code 0> <sup>a)</sup>							
Byte 9	not relevant	-	-	-	-	-	-	-	-

a) only with IPC02

A fixed code is read once.

**Auto Read Fixcode**

Byte	Content	B7	B6	B5	B4	B3	B2	B1	B0
Byte 0	Command code	0	0	0	0	1	0	0	0
Byte 1	Reserved/Toggle bit	-	-	-	-	-	-	-	T
Byte 2	not relevant	-	-	-	-	-	-	-	-
.	.	-	-	-	-	-	-	-	-
.	.	-	-	-	-	-	-	-	-
Byte 9	not relevant	-	-	-	-	-	-	-	-

**Response:**

Byte	Content	B7	B6	B5	B4	B3	B2	B1	B0
Byte 0	Command code	0	0	0	0	1	0	0	0
Byte 1	Reserved/Toggle bit	-	-	-	-	-	-	-	T
Byte 2	Status	<Status>							
Byte 3	Execution counter	<ExecCounter>							
Byte 4	ID-Code 00 ... FF <sub>h</sub> <sup>a)</sup>	<ID-Code 4> <sup>a)</sup> / <sub>&lt;ID-Code 3&gt;</sub>							
Byte 5	ID-Code 00 ... FF <sub>h</sub> <sup>a)</sup>	<ID-Code 3> <sup>a)</sup> / <sub>&lt;ID-Code 2&gt;</sub>							
Byte 6	ID-Code 00 ... FF <sub>h</sub> <sup>a)</sup>	<ID-Code 2> <sup>a)</sup> / <sub>&lt;ID-Code 1&gt;</sub>							
Byte 7	ID-Code 00 ... FF <sub>h</sub> <sup>a)</sup>	<ID-Code 1> <sup>a)</sup> / <sub>&lt;ID-Code 0&gt;</sub>							
Byte 8	ID-Code 00 ... FF <sub>h</sub> <sup>a)</sup>	<ID-Code 0> <sup>a)</sup>							
Byte 9	not relevant	-	-	-	-	-	-	-	-

a) only with IPC02

An attempt is made to read until a fixed code has been read.

**Buffered Read Fixcode**

Byte	Content	B7	B6	B5	B4	B3	B2	B1	B0
Byte 0	Command code	0	0	0	0	1	0	0	1
Byte 1	Reserved/Toggle bit	-	-	-	-	-	-	-	T
Byte 2	not relevant	-	-	-	-	-	-	-	-
.	.	-	-	-	-	-	-	-	-
.	.	-	-	-	-	-	-	-	-
.	.	-	-	-	-	-	-	-	-
Byte 9	not relevant	-	-	-	-	-	-	-	-

**Response:**

Byte	Content	B7	B6	B5	B4	B3	B2	B1	B0
Byte 0	Command code	0	0	0	0	1	0	0	1
Byte 1	Reserved/Toggle bit	-	-	-	-	-	-	-	T
Byte 2	Status	<Status>							
Byte 3	Execution counter	<ExecCounter>							
Byte 4	ID-Code 00 ... FF <sub>n</sub> <sup>a)</sup>	<ID-Code 4>/<ID-Code 3>							
Byte 5	ID-Code 00 ... FF <sub>n</sub> <sup>a)</sup>	<ID-Code 3>/<ID-Code 2>							
Byte 6	ID-Code 00 ... FF <sub>n</sub> <sup>a)</sup>	<ID-Code 2>/<ID-Code 1>							
Byte 7	ID-Code 00 ... FF <sub>n</sub> <sup>a)</sup>	<ID-Code 1>/<ID-Code 0>							
Byte 8	ID-Code 00 ... FF <sub>n</sub> <sup>a)</sup>	<ID-Code 0> <sup>a)</sup>							
Byte 9	not relevant	-	-	-	-	-	-	-	-

a) only with IPC02

The fixcode continues to be read. Only changed data is transferred via the interface.

**Enhanced Buffered Read Fixcode**

Byte	Content	B7	B6	B5	B4	B3	B2	B1	B0
Byte 0	Command code	0	0	0	1	1	1	0	1
Byte 1	Reserved/Toggle bit	-	-	-	-	-	-	-	T
Byte 2	not relevant	-	-	-	-	-	-	-	-
.	.	-	-	-	-	-	-	-	-
.	.	-	-	-	-	-	-	-	-
.	.	-	-	-	-	-	-	-	-
Byte 9	not relevant	-	-	-	-	-	-	-	-

**Response:**

Byte	Content	B7	B6	B5	B4	B3	B2	B1	B0
Byte 0	Command code	0	0	0	1	1	1	0	1
Byte 1	Reserved/Toggle bit	-	-	-	-	-	-	-	T
Byte 2	Status	<Status>							
Byte 3	Execution counter	<ExecCounter>							
Byte 4	ID-Code 00 ... FF <sub>h</sub> <sup>a)</sup>	<ID-Code 4> <sup>a)</sup> / <sup>a)</sup> <ID-Code 3>							
Byte 5	ID-Code 00 ... FF <sub>h</sub> <sup>a)</sup>	<ID-Code 3> <sup>a)</sup> / <sup>a)</sup> <ID-Code 2>							
Byte 6	ID-Code 00 ... FF <sub>h</sub> <sup>a)</sup>	<ID-Code 2> <sup>a)</sup> / <sup>a)</sup> <ID-Code 1>							
Byte 7	ID-Code 00 ... FF <sub>h</sub> <sup>a)</sup>	<ID-Code 1> <sup>a)</sup> / <sup>a)</sup> <ID-Code 0>							
Byte 8	ID-Code 00 ... FF <sub>h</sub> <sup>a)</sup>	<ID-Code 0> <sup>a)</sup>							
Byte 9	not relevant	-	-	-	-	-	-	-	-

a) only with IPC02

The fixcode continues to be read. Only changed data is transferred via the interface. If the code or data carrier leaves the read range, the status "05h" is output.

7.7 Special command modes

7.7.1 IPC03 configuration



**Note!**

These commands can only be used when data carrier type 03 (IPC03) is set. They cannot be used in the autodetect mode (mixed operation, data carrier type 00)!

The storage of a type IPC03 data carrier is organized by word. Every "word" is made up of 32 bits. For the normal data range, 29 words from addresses 3 through 31 (<WordAddr> = 00<sub>h</sub> ... 1C<sub>h</sub>) are available.

The storage of the data carrier IPC03 is constructed in the following way:

Address	Meaning	<WordAddr>	<ConfAddr>	Note
Word 0	Password	-	-	Write only
Word 1	Protection word	-	"1"	Read/write
Word 3	Control word	-	"2"	Read/write
Word 3...31	Data range	"00"... "1C"	-	Read/write
Word 32	Device Serial Number	"1D"	-	Read only
Word 33	Device identification	"1E"	-	Read only

The IPC03 has one "protection word" and one "control word". With the "protection word", a read-protected and a write-protected range can be defined. For this, each start and end of a read-protected and a write-protected range can be defined. With the "control word", various operating modes and the read range for the "default read" operating mode are set. Both words can only be accessed with the correct password.

The bits of the individual words have the following meaning:

**Control word**

Bit	Meaning	Byte
0...7	Read range start	0
8 ... 15	Read range end	1
16	Password protection on/off	2
17	"Read after write" operating mode on/off	
18 ... 23	Open	3
24 ... 31	Open	

**Protection word**

Bit	Meaning	Byte
0 ... 7	First read-protected word	0
8 ... 15	Last read-protected word	1
16 ... 23	First write-protected word	2
24 ... 31	Last write-protected word	3

With the control and protection word, it should be noted that when communicating a word, the highest value byte is transferred first and the lowest value byte last. With the entry of the read and write-protected words, the words are counted as follows:

00	Password
01	Protection word
02	Control word
03	1. Data word
04	2. Data word
...	...
1F	29. Data word

**IPC03 password mode**

It is possible to protect the control word and the protection word from being overwritten. Then the configuration can no longer be changed. The password mode serves this purpose.

With password mode active in the data carrier, the data range of a data carrier can only be read or written after the correct password is sent to the data carrier from the read/write head. The following must apply for this:

- The correct password is set once with the command **PS** "set password" and
- the password mode is activated with the command **PM** "set password mode".

The password in the read/write head and on the data carrier can be changed with the command **PC**.

If the password mode is deactivated, every word on the data carrier can be read and written as necessary.

In the factory default condition of the read heads and the data carrier IPC03, the password is 0000000<sub>n</sub>. In the read head, the password is stored in a volatile manner and in the data carrier IPC03 in a non-volatile manner.

**"Default read"**

In the "default read" operating mode 1 or 2, words can be read very quickly, because the memory to be read is already defined on the data carrier and does not need to be communicated to the data carrier from the read/write head first.

The start and end of the read range are stored in the bytes 0 and 1 of the "control word". As soon as the data carrier is supplied with energy the data carrier sends out the data from the data range, which is defined by the read range start and end. The data range between read range start and end can be read with the read commands **SR** (single read words) and **ER** (enhanced buffered read words) when <WordAddr> is set to 0000h and <WordNum> is set to 00h.

The advantages of the "default read" operating mode lie in the readout speed. The readout of one data word (4 bytes) is twice as fast in this mode. The readout of 2 words takes approx. 1/3 less time. Starting at 3 data words there is no more time advantage since this mode is only intended for the reading of a maximum of 2 words (=8 bytes). Reading larger data ranges can lead to error messages when the read head does not respond within the planned reaction time.

**Single Write Configuration**

Byte	Content	B7	B6	B5	B4	B3	B2	B1	B0
Byte 0	Command code	0	0	0	1	0	0	1	0
Byte 1	Reserved/Toggle bit	-	-	-	-	-	-	-	T
Byte 2	not relevant	-	-	-	-	-	-	-	-
Byte 3	Address in the configuration range	<RegAddr>							
Byte 4	Data 00 ... FF <sub>h</sub>	<Data>							
Byte 5	Data 00 ... FF <sub>h</sub>	<Data>							
Byte 6	Data 00 ... FF <sub>h</sub>	<Data>							
Byte 7	Data 00 ... FF <sub>h</sub>	<Data>							
Byte 8	not relevant	-	-	-	-	-	-	-	-
Byte 9	not relevant	-	-	-	-	-	-	-	-

**Response:**

Byte	Content	B7	B6	B5	B4	B3	B2	B1	B0
Byte 0	Command code	0	0	0	1	0	0	1	0
Byte 1	Reserved/Toggle bit	-	-	-	-	-	-	-	T
Byte 2	Status	<Status>							
Byte 3	Execution counter	<ExecCounter>							
Byte 4	not relevant	-	-	-	-	-	-	-	-
.	.	-	-	-	-	-	-	-	-
.	.	-	-	-	-	-	-	-	-
Byte 9	not relevant	-	-	-	-	-	-	-	-

One attempt is made to write a word in the configuration range from the address <RegAddr>. In order to write in the configuration range, the password mode must be active.

205842-2/09-03



**Auto Write Configuration**

Byte	Content	B7	B6	B5	B4	B3	B2	B1	B0
Byte 0	Command code	0	0	0	1	0	0	1	1
Byte 1	Reserved/Toggle bit	-	-	-	-	-	-	-	T
Byte 2	not relevant	-	-	-	-	-	-	-	-
Byte 3	Address in the configuration range	<RegAddr>							
Byte 4	Data 00 ... FF <sub>n</sub>	<Data>							
Byte 5	Data 00 ... FF <sub>n</sub>	<Data>							
Byte 6	Data 00 ... FF <sub>n</sub>	<Data>							
Byte 7	Data 00 ... FF <sub>n</sub>	<Data>							
Byte 8	not relevant	-	-	-	-	-	-	-	-
Byte 9	not relevant	-	-	-	-	-	-	-	-

**Response:**

Byte	Content	B7	B6	B5	B4	B3	B2	B1	B0
Byte 0	Command code	0	0	0	1	0	0	1	1
Byte 1	Reserved/Toggle bit	-	-	-	-	-	-	-	T
Byte 2	Status	<Status>							
Byte 3	Execution counter	<ExecCounter>							
Byte 4	not relevant	-	-	-	-	-	-	-	-
.	.	-	-	-	-	-	-	-	-
.	.	-	-	-	-	-	-	-	-
Byte 9	not relevant	-	-	-	-	-	-	-	-

An attempt is made to write a word in the configuration range from the address until successful. <RegAddr>. In order to write in the configuration range, the password mode must be active.

**Buffered Write Configuration**

Byte	Content	B7	B6	B5	B4	B3	B2	B1	B0
Byte 0	Command code	0	0	0	1	0	1	0	0
Byte 1	Reserved/Toggle bit	-	-	-	-	-	-	-	T
Byte 2	not relevant	-	-	-	-	-	-	-	-
Byte 3	Address in the configuration range	<RegAddr>							
Byte 4	Data 00 ... FF <sub>h</sub>	<Data>							
Byte 5	Data 00 ... FF <sub>h</sub>	<Data>							
Byte 6	Data 00 ... FF <sub>h</sub>	<Data>							
Byte 7	Data 00 ... FF <sub>h</sub>	<Data>							
Byte 8	not relevant	-	-	-	-	-	-	-	-
Byte 9	not relevant	-	-	-	-	-	-	-	-

**Response:**

Byte	Content	B7	B6	B5	B4	B3	B2	B1	B0
Byte 0	Command code	0	0	0	1	0	1	0	0
Byte 1	Reserved/Toggle bit	-	-	-	-	-	-	-	T
Byte 2	Status	<Status>							
Byte 3	Execution counter	<ExecCounter>							
Byte 4	not relevant	-	-	-	-	-	-	-	-
.	.	-	-	-	-	-	-	-	-
.	.	-	-	-	-	-	-	-	-
.	.	-	-	-	-	-	-	-	-
Byte 9	not relevant	-	-	-	-	-	-	-	-

One attempt is made to write a word in the configuration range from the address <RegAddr> . After each successful write, the response is sent and the system waits until a new data carrier is within the detection range. The command then starts again from the beginning. In order to write in the configuration range, the password mode must be active.

**Enhanced Buffered Write Configuration**

Byte	Content	B7	B6	B5	B4	B3	B2	B1	B0
Byte 0	Command code	0	1	1	0	0	1	1	0
Byte 1	Reserved/Toggle bit	-	-	-	-	-	-	-	T
Byte 2	not relevant	-	-	-	-	-	-	-	-
Byte 3	Address in the configuration range	<RegAddr>							
Byte 4	Data 00 ... FF <sub>n</sub>	<Data>							
Byte 5	Data 00 ... FF <sub>n</sub>	<Data>							
Byte 6	Data 00 ... FF <sub>n</sub>	<Data>							
Byte 7	Data 00 ... FF <sub>n</sub>	<Data>							
Byte 8	not relevant	-	-	-	-	-	-	-	-
Byte 9	not relevant	-	-	-	-	-	-	-	-

**Response:**

Byte	Content	B7	B6	B5	B4	B3	B2	B1	B0
Byte 0	Command code	0	1	1	0	0	1	1	0
Byte 1	Reserved/Toggle bit	-	-	-	-	-	-	-	T
Byte 2	Status	<Status>							
Byte 3	Execution counter	<ExecCounter>							
Byte 4	not relevant	-	-	-	-	-	-	-	-
.	.	-	-	-	-	-	-	-	-
.	.	-	-	-	-	-	-	-	-
.	.	-	-	-	-	-	-	-	-
Byte 9	not relevant	-	-	-	-	-	-	-	-

One attempt is made to write a word in the configuration range from the address <RegAddr>. After each successful write, the response is sent and the system waits until a new data carrier is within the detection range. The command then starts again from the beginning. In order to write in the configuration range, the password mode must be active. When the data carrier leaves the read range, the status "05<sub>n</sub>" is output.

Single Get Configuration

Byte	Content	B7	B6	B5	B4	B3	B2	B1	B0
Byte 0	Command code	0	1	1	0	0	0	0	1
Byte 1	Reserved/Toggle bit	-	-	-	-	-	-	-	T
Byte 2	Reserved	0	0	0	0	0	0	0	0
Byte 3	Register address	<RegAddr>							
Byte 4	not relevant	-	-	-	-	-	-	-	-
.	.	-	-	-	-	-	-	-	-
.	.	-	-	-	-	-	-	-	-
Byte 9	not relevant	-	-	-	-	-	-	-	-

**Response:**

Byte	Content	B7	B6	B5	B4	B3	B2	B1	B0
Byte 0	Command code	0	1	1	0	0	0	0	1
Byte 1	Reserved/Toggle bit	-	-	-	-	-	-	-	T
Byte 2	Status	<Status>							
Byte 3	Execution character	<ExecCounter>							
Byte 4	Data 00 ... FF <sub>h</sub>	<Data>							
Byte 5	Data 00 ... FF <sub>h</sub>	<Data>							
Byte 6	Data 00 ... FF <sub>h</sub>	<Data>							
Byte 7	Data 00 ... FF <sub>h</sub>	<Data>							
Byte 8	not relevant	-	-	-	-	-	-	-	-
Byte 9	not relevant	-	-	-	-	-	-	-	-

One attempt is made to read a word in the configuration range ("protection word" or "control word") from the address <RegAddr>.

**Auto Get Configuration**

Byte	Content	B7	B6	B5	B4	B3	B2	B1	B0
Byte 0	Command code	0	1	1	0	0	0	1	0
Byte 1	Reserved/Toggle bit	-	-	-	-	-	-	-	T
Byte 2	Reserved	0	0	0	0	0	0	0	0
Byte 3	Register address	<RegAddr>							
Byte 4	not relevant	-	-	-	-	-	-	-	-
.	.	-	-	-	-	-	-	-	-
.	.								
Byte 9	not relevant	-	-	-	-	-	-	-	-

**Response:**

Byte	Content	B7	B6	B5	B4	B3	B2	B1	B0
Byte 0	Command code	0	1	1	0	0	0	1	0
Byte 1	Reserved/Toggle bit	-	-	-	-	-	-	-	T
Byte 2	Status	<Status>							
Byte 3	Execution character	<ExecCounter>							
Byte 4	Data 00 ... FF <sub>h</sub>	<Data>							
Byte 5	Data 00 ... FF <sub>h</sub>	<Data>							
Byte 6	Data 00 ... FF <sub>h</sub>	<Data>							
Byte 7	Data 00 ... FF <sub>h</sub>	<Data>							
Byte 8	not relevant	-	-	-	-	-	-	-	-
Byte 9	not relevant	-	-	-	-	-	-	-	-

Repeated attempts are made until successful, to read a word in the configuration range from the address <RegAddr> .

**Buffered Get Configuration**

Byte	Content	B7	B6	B5	B4	B3	B2	B1	B0
Byte 0	Command code	0	1	1	0	0	0	1	1
Byte 1	Reserved/Toggle bit	-	-	-	-	-	-	-	T
Byte 2	Reserved	0	0	0	0	0	0	0	0
Byte 3	Register address	<RegAddr>							
Byte 4	not relevant	-	-	-	-	-	-	-	-
.	.	-	-	-	-	-	-	-	-
.	.	-	-	-	-	-	-	-	-
Byte 9	not relevant	-	-	-	-	-	-	-	-

**Response:**

Byte	Content	B7	B6	B5	B4	B3	B2	B1	B0
Byte 0	Command code	0	1	1	0	0	0	1	1
Byte 1	Reserved/Toggle bit	-	-	-	-	-	-	-	T
Byte 2	Status	<Status>							
Byte 3	Execution character	<ExecCounter>							
Byte 4	Data 00 ... FF <sub>h</sub>	<Data>							
Byte 5	Data 00 ... FF <sub>h</sub>	<Data>							
Byte 6	Data 00 ... FF <sub>h</sub>	<Data>							
Byte 7	Data 00 ... FF <sub>h</sub>	<Data>							
Byte 8	not relevant	-	-	-	-	-	-	-	-
Byte 9	not relevant	-	-	-	-	-	-	-	-

An attempt is made to write a word in the configuration range from the address until successful. <RegAddr>. Only changed data is transferred via the interface.

**Enhanced Buffered Get Configuration**

Byte	Content	B7	B6	B5	B4	B3	B2	B1	B0
Byte 0	Command code	0	1	1	0	1	0	0	0
Byte 1	Reserved/Toggle bit	-	-	-	-	-	-	-	T
Byte 2	Reserved	0	0	0	0	0	0	0	0
Byte 3	Register address	<RegAddr>							
Byte 4	not relevant	-	-	-	-	-	-	-	-
.	.	-	-	-	-	-	-	-	-
.	.								
Byte 9	not relevant	-	-	-	-	-	-	-	-

**Response:**

Byte	Content	B7	B6	B5	B4	B3	B2	B1	B0
Byte 0	Command code	0	1	1	0	1	0	0	0
Byte 1	Reserved/Toggle bit	-	-	-	-	-	-	-	T
Byte 2	Status	<Status>							
Byte 3	Execution character	<ExecCounter>							
Byte 4	Data 00 ... FF <sub>n</sub>	<Data>							
Byte 5	Data 00 ... FF <sub>n</sub>	<Data>							
Byte 6	Data 00 ... FF <sub>n</sub>	<Data>							
Byte 7	Data 00 ... FF <sub>n</sub>	<Data>							
Byte 8	not relevant	-	-	-	-	-	-	-	-
Byte 9	not relevant	-	-	-	-	-	-	-	-

An attempt is made to write a word in the configuration range from the address until successful. <RegAddr>. Only changed data is transferred via the interface. When the data carrier leaves the read range, the status "05h" is output.

## 7.7.2 Password mode with IPC03



**Note!**

The password is a 32-bit word that is set to "0" before a new IPC03 data carrier leaves the factory. The password cannot be read. In order to write the passwords for the "Control Word" and the "Protection Word", the processing must always be in password mode.

### Password Mode

Byte	Content	B7	B6	B5	B4	B3	B2	B1	B0
Byte 0	Command code	0	0	0	1	1	0	0	0
Byte 1	Reserved/Toggle bit	-	-	-	-	-	-	-	T
Byte 2	Mode (on:<F>=1, off:<F>=0)	0	0	0	0	0	0	0	<F>
Byte 3	not relevant	-	-	-	-	-	-	-	-
.	.	-	-	-	-	-	-	-	-
.	.	-	-	-	-	-	-	-	-
.	.	-	-	-	-	-	-	-	-
Byte 9	not relevant	-	-	-	-	-	-	-	-

**Response:**

Byte	Content	B7	B6	B5	B4	B3	B2	B1	B0
Byte 0	Command code	0	0	0	1	1	0	0	0
Byte 1	Reserved/Toggle bit	-	-	-	-	-	-	-	T
Byte 2	Status	<Status>							
Byte 3	not relevant	-	-	-	-	-	-	-	-
.	.	-	-	-	-	-	-	-	-
.	.	-	-	-	-	-	-	-	-
.	.	-	-	-	-	-	-	-	-
Byte 9	not relevant	-	-	-	-	-	-	-	-

Activates (Mode <F> = "1") and deactivates (Mode <F> = "0") the password mode of the read head. In the password mode, the password is transferred to the data carrier before each read/write access. If a data carrier is addressed with the wrong password, then even the data range, for which no password protection is set, cannot be accessed.



**Password Change**

Byte	Content	B7	B6	B5	B4	B3	B2	B1	B0
Byte 0	Command code	0	1	0	0	0	0	0	1
Byte 1	Reserved/Toggle bit	-	-	-	-	-	-	-	T
Byte 2	Old password 00 ... FF <sub>h</sub>	<PSW 3>							
Byte 3	Old password 00 ... FF <sub>h</sub>	<PSW 2>							
Byte 4	Old password 00 ... FF <sub>h</sub>	<PSW 1>							
Byte 5	Old password 00 ... FF <sub>h</sub>	<PSW 0>							
Byte 6	New password 00 ... FF <sub>h</sub>	<PSW 3>							
Byte 7	New password 00 ... FF <sub>h</sub>	<PSW 2>							
Byte 8	New password 00 ... FF <sub>h</sub>	<PSW 1>							
Byte 9	New password 00 ... FF <sub>h</sub>	<PSW 0>							

**Response:**

Byte	Content	B7	B6	B5	B4	B3	B2	B1	B0
Byte 0	Command code	0	1	0	0	0	0	0	1
Byte 1	Reserved/Toggle bit	-	-	-	-	-	-	-	T
Byte 2	Status	<Status>							
Byte 3	not relevant	-	-	-	-	-	-	-	-
.	.	-	-	-	-	-	-	-	-
.	.	-	-	-	-	-	-	-	-
Byte 9	not relevant	-	-	-	-	-	-	-	-

Changes the password in a data carrier. Here, first the old and then the new password has to be entered. If the password has been successfully written, then the password in the read/write head is also changed. The command "password set" is no longer necessary. The IPC03 password can also be changed when the password mode is deactivated.

**Password Set**

Byte	Content	B7	B6	B5	B4	B3	B2	B1	B0
Byte 0	Command code	0	1	0	0	0	0	1	0
Byte 1	Reserved/Toggle bit	-	-	-	-	-	-	-	T
Byte 2	not relevant	-	-	-	-	-	-	-	-
Byte 3	not relevant	-	-	-	-	-	-	-	-
Byte 4	Password 00 ... FF <sub>h</sub>	<PSW 3>							
Byte 5	Password 00 ... FF <sub>h</sub>	<PSW 2>							
Byte 6	Password 00 ... FF <sub>h</sub>	<PSW 1>							
Byte 7	Password 00 ... FF <sub>h</sub>	<PSW 0>							
Byte 8	not relevant	-	-	-	-	-	-	-	-
Byte 9	not relevant	-	-	-	-	-	-	-	-

**Response:**

Byte	Content	B7	B6	B5	B4	B3	B2	B1	B0
Byte 0	Command code	0	1	0	0	0	0	1	0
Byte 1	Reserved/Toggle bit	-	-	-	-	-	-	-	T
Byte 2	Status	<Status>							
Byte 3	not relevant	-	-	-	-	-	-	-	-
.	.	-	-	-	-	-	-	-	-
.	.	-	-	-	-	-	-	-	-
Byte 9	not relevant	-	-	-	-	-	-	-	-

Sets the password, which the read/write head communicates to the data carrier in the password mode.

### 7.7.3 Write fixed code IPC10

#### Single Write Fixcode

Byte	Content	B7	B6	B5	B4	B3	B2	B1	B0
Byte 0	Command code	0	0	0	1	1	1	1	1
Byte 1	FixLen/Toggle bit	<FixLen>			-	-	-	T	
Byte 2	Fixtype	<FixType> (High Byte)							
Byte 3	Fixtype	<FixType> (Low Byte)							
Byte 4	Data 00 ... FF <sub>n</sub>	<Data>							
.	Data 00 ... FF <sub>n</sub>	<Data>							
.	Data 00 ... FF <sub>n</sub>	<Data>							
Byte 9	Data 00 ... FF <sub>n</sub>	<Data>							

#### Response:

Byte	Content	B7	B6	B5	B4	B3	B2	B1	B0
Byte 0	Command code	0	0	0	1	1	1	1	1
Byte 1	FixLen/Toggle bit	<FixLen>			-	-	-	T	
Byte 2	Status	<Status>							
Byte 3	Execution counter	<ExecCounter>							
Byte 4	not relevant	-	-	-	-	-	-	-	-
.	.	-	-	-	-	-	-	-	-
.	.	-	-	-	-	-	-	-	-
Byte 9	not relevant	-	-	-	-	-	-	-	-

One attempt is made to write a fixed code. This <FixType> is always "02" and <FixLen> "05<sub>n</sub>", since 5 bytes must always be written.

**Auto Write Fixcode**

Byte	Content	B7	B6	B5	B4	B3	B2	B1	B0
Byte 0	Command code	0	1	1	0	0	1	0	0
Byte 1	FixLen/Toggle bit	<FixLen>				-	-	-	T
Byte 2	FixType	<FixType> (High Byte)							
Byte 3	FixType	<FixType> (Low Byte)							
Byte 4	Data 00 ... FF <sub>h</sub>	<Data>							
.	Data 00 ... FF <sub>h</sub>	<Data>							
.	Data 00 ... FF <sub>h</sub>	<Data>							
Byte 9	Data 00 ... FF <sub>h</sub>	<Data>							

**Response:**

Byte	Content	B7	B6	B5	B4	B3	B2	B1	B0
Byte 0	Command code	0	1	1	0	0	1	0	0
Byte 1	FixLen/Toggle bit	<FixLen>				-	-	-	T
Byte 2	Status	<Status>							
Byte 3	Execution counter	<ExecCounter>							
Byte 4	not relevant	-	-	-	-	-	-	-	-
.	.	-	-	-	-	-	-	-	-
.	.	-	-	-	-	-	-	-	-
Byte 9	not relevant	-	-	-	-	-	-	-	-

An attempt is made to write a fixcode until successful.

**Buffered Write Fixcode**

Byte	Content	B7	B6	B5	B4	B3	B2	B1	B0
Byte 0	Command code	0	1	1	0	0	1	0	1
Byte 1	FixLen/Toggle bit	<FixLen>				-	-	-	T
Byte 2	FixType	<FixType> (High Byte)							
Byte 3	FixType	<FixType> (Low Byte)							
Byte 4	Data 00 ... FF <sub>n</sub>	<Data>							
.	Data 00 ... FF <sub>n</sub>	<Data>							
.	Data 00 ... FF <sub>n</sub>	<Data>							
Byte 9	Data 00 ... FF <sub>n</sub>	<Data>							

**Response:**

Byte	Content	B7	B6	B5	B4	B3	B2	B1	B0
Byte 0	Command code	0	1	1	0	0	1	0	1
Byte 1	FixLen/Toggle bit	<FixLen>				-	-	-	T
Byte 2	Status	<Status>							
Byte 3	Execution counter	<ExecCounter>							
Byte 4	not relevant	-	-	-	-	-	-	-	-
.	.	-	-	-	-	-	-	-	-
.	.	-	-	-	-	-	-	-	-
Byte 9	not relevant	-	-	-	-	-	-	-	-

One attempt is made to write a fixcode. After each successful write, the response is sent and the system waits until a new data carrier is within the detection range. The command then starts again from the beginning.

Enhanced buffered write fixed code; write ID code

Byte	Content	B7	B6	B5	B4	B3	B2	B1	B0
Byte 0	Command code	0	0	1	0	0	1	0	0
Byte 1	FixLen/Toggle bit	<FixLen>				-	-	-	T
Byte 2	Fixtype	<FixType> (High Byte)							
Byte 3	Fixtype	<FixType> (Low Byte)							
Byte 4	Data 00 ... FF <sub>h</sub>	<Data>							
.	Data 00 ... FF <sub>h</sub>	<Data>							
.	Data 00 ... FF <sub>h</sub>	<Data>							
Byte 9	Data 00 ... FF <sub>h</sub>	<Data>							

**Response:**

Byte	Content	B7	B6	B5	B4	B3	B2	B1	B0
Byte 0	Command code	0	0	1	0	0	1	0	0
Byte 1	FixLen/Toggle bit	<FixLen>				-	-	-	T
Byte 2	Status	<Status>							
Byte 3	Execution counter	<ExecCounter>							
Byte 4	not relevant	-	-	-	-	-	-	-	-
.	.	-	-	-	-	-	-	-	-
.	.	-	-	-	-	-	-	-	-
Byte 9	not relevant	-	-	-	-	-	-	-	-

One attempt is made to write a fixcode. After each successful write, the response is sent and the system waits until a new data carrier is within the detection range. The command then starts again from the beginning. When the data carrier leaves the read range, the status "05<sub>h</sub>" is output.

## 7.8 Legend

<ConfAddr>	:	Word start address in the configuration range of the data carrier. 1 ASCII character range from "0" to "F", depending on data carrier type. The following applies for IPC03: "1" = Protection Word "2" = Control Word
<Data>	:	<WordNum> times 4 Bytes. When communicating a word, the highest value byte is transferred first and the lowest value byte last.
<ExecCounter>	:	1 byte
<FixLen>	:	4 Bits
<FixType>	:	2 ASCII characters, for example: for IPC02 "02" (32h 30h)
<IDCode>	:	4 bytes for IPC03 5 bytes for IPC02 and IPC11
Mode <F>	:	1 ASCII character "0" or "1"
<Parameter>:	:	1 Byte, range of values 01h to 08h
<PSW>	:	4 Bytes, password
<RegAddr>:	:	4 Bytes
<Status>	:	1 byte
<T>	:	1 Bit 0 (0b); 1 (1b)
<TagType>	:	2 ASCII characters, for example: '02' for IPC02
<VersionData>	:	6 ASCII characters, software version message
<WordAddr>	:	4 Bytes Word start address in the data carrier, range from "0000" to "FFFF", depending on data carrier type.
<WordNum>	:	4 Bits Number of words to be read or written, 01h ("0001") is used as number of words. The following applies for IPC03: The number of words 00h is used with the word address "0000" to read the preset data range on the data carrier.

7.9 Error/Status messages

Status	Meaning
00h	The command has been executed without error.
FFh	The command is processing.

Error messages which triggered the identification system

Status	Meaning
02h	Switch-on message. Reset has been executed.
03h	Reserved
04h	Incorrect or incomplete command or parameter not in the valid range.
05h	Read/write error. No data carrier in the detection range.
06h	Hardware error, e.g. error on self test or read head defect.
07h	Internal device error.
08h	Reserved
09h	Reserved
0Ah	Reserved
0Bh	Reserved
0Ch	Reserved
0Dh	Reserved
0Eh	Reserved
0Fh	Reserved

Error messages, which triggered the lower section U-P6-B5\*

Status	Meaning
10h	Reserved
20h	Reset has been executed.
40h	Incorrect or incomplete command or parameter not in the valid range.
60h	Hardware error, e.g. no communication with the identification system.
70h	Internal device error.



## 8 Technical specifications

### 8.1 Read/write station IPT\*-FP

#### IPT\*-FP

##### General data

Operating frequency	125 kHz
Transfer rate	2 kBit/s
Operating distance	max. 100 mm

##### Display/controls

LED green	Power on
LED yellow	IPC recognized
LED red	Bus error (with the use of field bus interfaces)

##### Electrical data

Rated operating voltage $U_e$	20 ... 30 V DC, ripple 10 % <sub>SS</sub> , PELV
Power consumption $P_0$	max. 5 W, in connection with lower section
Galvanic isolation	
Operating voltage/Interface	Functional isolation in accordance with DIN EN 50178, rated isolation voltage 50 V <sub>eff</sub>

##### Interface

Physical	Interface type depends on the lower section used
----------	--

##### Ambient conditions

Ambient temperature	-25 ... 70 °C (248 ... 343 K)
Storage temperature	-40 ... 85 °C (233 ... 358 K)

##### Mechanical data

Degree of protection	IP67 in accordance with IN 60529, in connection with lower section
Housing material	PBT (Polybutylene terephthalate)

**Dimensions of the read/write station**

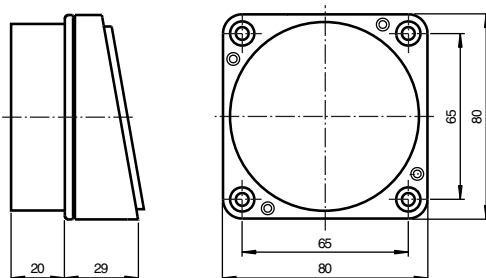

**8.2 Read/write distances IPT\*-FP**

Distances	Data carrier type	in air
Read distance with	IPC02-20W	0 mm...40 mm
Read distance with	IPC02-30W	0 mm...50 mm
Read distance with	IPC02-50W	0 mm...80 mm
Read distance with	IPC02-C1	0 mm...80 mm
Read distance with	IPC02-68-T5	0 mm...50 mm
Read distance with	IPC03-20W	0 mm...30 mm
Write distance with	IPC03-20W	0 mm...25 mm
Read distance with	IPC03-30W	0 mm...40 mm
Write distance with	IPC03-30W	0 mm...30 mm
Read distance with	IPC03-50W	0 mm...60 mm
Write distance with	IPC03-50W	0 mm...45 mm
Read distance with	IPC03-C1	0 mm...60 mm
Write distance with	IPC03-C1	0 mm...45 mm
Read distance with	IPC10-20	0 mm...30 mm
Write distance with	IPC10-20	0 mm...25 mm

205842.2/009-03

### 8.3 U-P6-B5-V lower section

U-P6-B5	
<b>Electrical data</b>	
Rated operating voltage $U_e$	20 ... 30 V DC, ripple 10 % <sub>SS</sub> , PELV
Current loading	< 300 mA ( $U_e = 24$ V) with read/write station
Power consumption $P_0$	max. 5 W with read/write station
Galvanic isolation	
Operating voltage/Interface	Functional isolation in accordance with DIN EN 50178, rated isolation voltage 50 V <sub>eff</sub>
<b>Interface</b>	
BUS interface	INTERBUS installation remote bus
BUS protocol	INTERBUS remote bus
Interface	RS 485
ID code	03
Transfer rate	500 kBit/s or 2 MBit/s can be switched internally
Ring termination	automatic via plug-in contact
<b>Ambient conditions</b>	
Ambient temperature	-25 ... 70 °C (248 ... 343 K)
Storage temperature	-40 ... 85 °C (233 ... 358 K)
<b>Mechanical data</b>	
Degree of protection	IP67 according to EN 60529 with IPT*-FP
Connection	
BUS Voltage supply	Round connector M23 8+1 Pin 3 x 2 x 0.22 mm <sup>2</sup> + 3 x 1 mm <sup>2</sup> or 3 x 2 x 0.25 mm <sup>2</sup> + 3 x 1 mm <sup>2</sup>
PE	Crimp connector < 4mm <sup>2</sup>
Housing material	Aluminum, black anodized

**U-P6-B5-V Lower section**

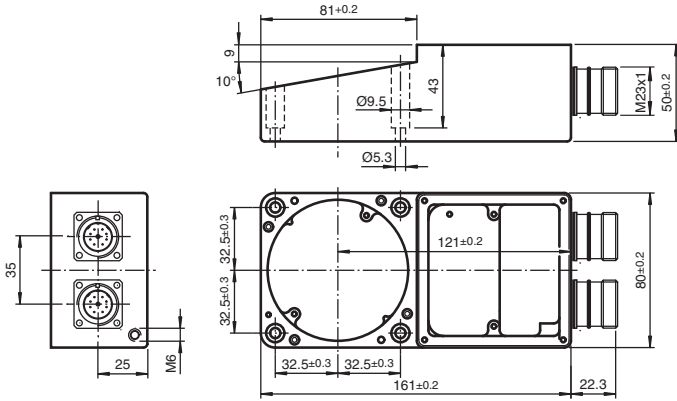

**Electrical connection**

incoming interface

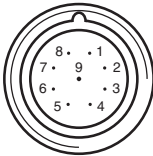

connector

outgoing interface

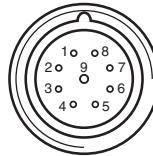

socket

- 1 DO1
- 2 /DO1
- 3 DI1
- 4 /DI1
- 5 GND
- 6 PE
- 7 +24 V
- 8 0 V
- 9

- 1 DO2
- 2 /DO2
- 3 DI2
- 4 /DI2
- 5 GND
- 6 PE
- 7 +24 V
- 8 0 V
- 9 /RBST



# FACTORY AUTOMATION – SENSING YOUR NEEDS



## Worldwide Headquarters

Pepperl+Fuchs GmbH  
68307 Mannheim · Germany  
Tel. +49 621 776-0  
E-mail: [info@de.pepperl-fuchs.com](mailto:info@de.pepperl-fuchs.com)

## USA Headquarters

Pepperl+Fuchs Inc.  
Twinsburg, Ohio 44087 · USA  
Tel. +1 330 4253555  
E-mail: [sales@us.pepperl-fuchs.com](mailto:sales@us.pepperl-fuchs.com)

## Asia Pacific Headquarters

Pepperl+Fuchs Pte Ltd.  
Company Registration No. 199003130E  
Singapore 139942  
Tel. +65 67799091  
E-mail: [sales@sg.pepperl-fuchs.com](mailto:sales@sg.pepperl-fuchs.com)

[www.pepperl-fuchs.com](http://www.pepperl-fuchs.com)

 **PEPPERL+FUCHS**  
SENSING YOUR NEEDS