

MANUAL

# Distance Measurement Series VDM100





With regard to the supply of products, the current issue of the following document is applicable:  
The General Terms of Delivery for Products and Services of the Electrical Industry, published by the Central Association of the Electrical Industry (Zentralverband Elektrotechnik und Elektroindustrie (ZVEI) e.V.) in its most recent version as well as the supplementary clause: "Expanded reservation of proprietorship"

Date of issue 09/21/2010 Part No. 206509

1	<b>Introduction</b>	<b>4</b>
1.1	Guarantee	4
2	<b>Declaration of Conformity</b>	<b>5</b>
3	Safety	6
3.1	Symbols used	6
3.2	General safety instructions	6
3.3	Proper use	7
4	Product description	7
4.1	Displays and controls	8
4.2	Scope of delivery:	9
4.3	Accessories	9
5	Installation	10
5.1	Storage and Transport	10
5.2	Unpacking	10
5.3	Mounting	10
5.4	Reflector selection	12
5.5	Reflector arrangement	13
6	Commissioning	13
6.1	Connecting the Device	14
6.2	Grounding / Shielding	15
6.3	Adjustment	15
6.4	Display indication	16
7	Settings	17
7.1	Menu Structure	17
7.2	Description of menu items	18
7.3	Operation	22
7.4	FAQ	23
8	Maintenance and Repair	23
9	Fault elimination	24
10	<b>Appendix</b>	<b>25</b>
10.1	<b>Technical data</b>	<b>25</b>
10.2	Model numbers	28
10.3	Description of Interfaces	29
10.4	Information on the GSD file (PROFIBUS DP)	32

## 1 Introduction

### Sincere congratulations

You have chosen a device from Pepperl+Fuchs. Pepperl+Fuchs develops, produces and markets electronic sensors and interface modules worldwide for the automation technology market.

### Contact

If you have any questions about the device, its functions, or accessories, please contact us at:

Pepperl+Fuchs GmbH  
Lilienthalstrasse 200  
D-68307 Mannheim  
Telephone: 0621 776-1111  
Fax: 0621 776-271111  
E-mail: fa-info@de.pepperl-fuchs.com

### 1.1 Guarantee

Pepperl+Fuchs manufactures its hardware products according to recognized industrial standards. Pepperl+Fuchs guarantees its products to be free of defects in material and workmanship provided the products are used under the normal operating conditions specified by the manufacturer. The warranty applies only to the original owner and is not transferable. All accompanying exclusions of liability, restrictions, and other conditions of this section apply to this warranty.

#### Exclusions of liability

No warranty obtained or granted hereby shall apply to products that:

- have been repaired, modified, or tampered with unless explicitly performed or approved by Pepperl+Fuchs,
- have not been serviced in accordance with the Operating and Handling Instructions provided by Pepperl+Fuchs,
- have been exposed to unusual physical or electrical loads, immersed in liquids, or exposed to any one of the following circumstances:
  - breakdown,
  - crushing,
  - improper use,
  - misuse,
  - low current,
  - unsuitable power supply
  - reverse polarity,
  - negligence or accident,
- or has been used for any purpose other than what is described in the Operating and Handling Instructions.

Preventive maintenance is the customer's responsibility and is not covered by this warranty.

### General

With the exception of the warranties noted above, Pepperl+Fuchs offers no warranties for products delivered below in any form whatsoever, whether explicit or implicit, including but not limited to implicit defect warranty services and guarantee of suitability for a specific purpose, and absence of injury. The explicit warranties noted above shall satisfy all obligations and liabilities of Pepperl+Fuchs for damages, including but not limited to concrete damages, indirect damages or consequential damages in connection with the use or design of the product. The seller's liability to the buyer and other persons (regardless of the origin of liability, whether it be based on contract, warranty, impermissible handling, misuse, and/or other origin) in connection with the use of a product shall in no case exceed the original purchase price of the product. Pepperl+Fuchs shall in no event be liable for consequential damages, concrete and indirect damages, secondary damages or penalties, or lost profits, sales, or loss of data, even if Pepperl+Fuchs had been made aware of this possibility.

## 2 Declaration of Conformity

We, Pepperl+Fuchs GmbH, hereby declare that the

### Distance Measurement Device VDM100

and all models of this product to which this declaration refers are in conformity with the following standards and other regulatory documents

#### EN 61326-1:2006, EN60947-5-2:2007

	The laser distance measurement device VDM100 was designed exclusively for use in industrial environments. The device may cause radio interference if used in a domestic environment.
---	---

Product family standard: Electromagnetic Compatibility (EMC for light industry and industry)

	A corresponding Declaration of Conformity may be requested from the manufacturer.
--	---



Pepperl+Fuchs GmbH in D-68301 Mannheim has a certified quality assurance system in conformity with ISO 9001.



### 3 Safety

#### 3.1 Symbols used

Safety-related symbols

	<p><b>Danger!</b> This symbol identifies an immediate and present danger. Failure to observe this warning may result in personal injury or even death.</p>
	<p><b>Warning!</b> This symbol warns of a possible malfunction or hazard. Failure to observe this warning may result in personal injury or extensive damage to property.</p>
	<p><b>Caution!</b> This symbol warns of a possible malfunction. If the instruction given in this warning is not heeded, the device and any plant or systems connected to it could develop a fault or fail completely.</p>

Informative symbols



**Note!**  
This symbol draws your attention to important information.



**Handling instructions**  
This symbol marks instructions for action.

#### 3.2 General safety instructions

The following basic instructions must be observed in all cases:

- The device must not be commissioned until the manual has been read and understood
- The power supply that generates the supply voltage must be reliably insulated electrically with double insulation and a safety transformer according to DIN VDE 0551 (corresponds to IEC 742).
- The device must not be used out of specification without suitable protective measures
- No unauthorized tampering with the device is permitted
- Do not point the device directly at the sun or measure into the sun
- Do not remove the warning instructions or rating plates

The radiation emitted by a Class 1 laser is harmless. This type of laser instrument can be operated by anyone.

The system operator is responsible for planning, mounting, commissioning, operation, and maintenance of the system.

Installation and commissioning of all devices must only be performed by personnel specially trained for that purpose.

The protection of the system and operating personnel is not ensured if the module is not used according to its intended purpose.

Observe the applicable laws and regulations for use and for the intended purpose. The devices are only approved for proper use in accordance with the intended purpose. Any other use voids all warranty claims and manufacturer's responsibility.

Use only recommended original accessories.

If you are unable to eliminate malfunctions, take the device out of operation. Secure the device against accidental operation. Return the device to Pepperl+Fuchs for repair. Interventions and modifications are potentially hazardous, and any warranty and manufacturer's liability shall become void.

Dispose of unusable devices in keeping with the applicable national legal regulations. For example, you can take the sensor to the designated collection point for electronic scrap.



*In applications with high storage racks and moving shuttles, care must always be taken to observe the applicable safety regulations. Failure to do so may result in serious or fatal injury!*

### 3.3 Proper use

Series VDM 100 distance measurement devices are used to determine the exact positioning of stock feeders, moving shuttles, cranes, and automatic handling equipment and for distance measurements in the woodworking industry, on concrete saws, and in elevator construction. It must be ensured that the devices are only used in accordance with their intended and designated purpose.

## 4 Product description

### VDM100

Exact positioning of stock feeders, moving shuttles, cranes, and automatic handling equipment, as well as distance measurements in the woodworking industry, on concrete saws, and in elevator construction requires distance measurement devices capable of returning measurement values at a high measurement rate over great distances with millimeter precision.

Distance measurement devices are used wherever distances were previously measured by shaft encoders or electromechanical measurement means. By their very nature, those mechanical measurement value generators are highly susceptible to changes in ambient conditions, for example temperature, and are also subject to aging and constant wear.

Photoelectric distance measurement devices are practically wear-free in operation and are easy to install with a built-in laser pointer.

Other advantages include short assembly and commissioning times, the high level of reliability offered by a photoelectric measurement system, and the ease of replacement.

The VDM series covers three standard distance ranges: 50 m, 150 m and 300 m.

Available interfaces include:

- SSI (Synchronous Serial Interface),
- INTERBUS,
- PROFIBUS DP

Series VDM100 photoelectric distance measurement devices meet the safety requirements of laser protection class 1 (EN 60825) in measurement mode. The low level of emitted laser light ensures that operating personnel will not be injured or suffer any adverse health effects.

### Measuring principle

The device works according to the principle of Pulse Ranging Technology (PRT). The time between when an invisible light pulse is emitted and when the reflected pulse is received is measured in the device. Since the speed of light is constant, this time serves as a measure of distance. The light source and receiver are both located in the device. A reflector is required for the distance measurement. It must be installed opposite the device. Because of its technical characteristics, the Pulse Ranging Technology (PRT) is especially suitable for highly accurate distance measurement over great distance compared to other methods. In comparison to other methods of distance measurement, a time-of-flight measurement is largely independent of the measurement environment and can therefore also be used in harsh everyday industrial settings with a high level of accuracy.



#### Effects of ambient conditions:

The speed of the propagation of light is independent of air temperature and pressure.

The effect of air temperature is 1 ppm/K

The effect of air pressure is -0.3 ppm/hPa

These errors must be taken into consideration by the user for long distances.

For example, in the working range of the VDM (-10 °C ... +50 °C) the error at a distance of 100 m is 6 mm.

## 4.1 Displays and controls

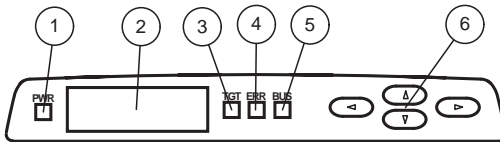

Figure 4.1: Displays and controls

No.	Name	Color	No.	Name	Color
1	Power LED	Green	4	ERROR LED	Red
2	Display		5	BUS LED	Green
3	TARGET LED	Green	6	Operating keys	

Table 4.2: Displays and controls















#### 4.2 Scope of delivery:

The delivery package contains:

- VDM100
- Manual
- Functional grounding (pre-mounted)
- Protective cap LS610

#### 4.3 Accessories

The following products are available as accessories:

No.	Name	Figure	Description
1	OMH-VDM100-01		Mounting bracket with deviation mirror
2	OMH-LS610-01		Mounting bracket
3	OMH-LS610-02		Direct installation set (4 threaded inserts M4)
4	OMH-LS610-04		Hood
5	Functional grounding LS610		Functional grounding
6	Protective cap LS610		M12 locking caps
7	ICZ-TR-V15B		PROFIBUS terminal resistor
8	Reflektor VDM01		Plastic reflector 500 mm x 500 mm
9	Reflektor VDM02 only in connection with the Reflector VDM01		Plastic reflector 500 mm x 250 mm
10	Reflector 250 mm x 250 mm		Foil reflector 250 mm x 250 mm
11	Reflector 500 mm x 500 mm		Foil reflector 500 mm x 500 mm
12	Reflector 1000 mm x 1000 mm		Foil reflector 1000 mm x 1000 mm



13	V15SB-G		Connector, M12 x 1, B coded, 5-pin for bus cable
14	V15B-G		Connector, M12 x 1, B coded, 5-pin for bus cable
15	V1-G		Connector, M12 x 1, 4-pin for power supply

Table 4.3: Accessories

## 5 Installation

### 5.1 Storage and Transport

Pack the device so it is protected against impacts during storage and transport and protect it against humidity. The original packaging offers optimum protection. Note also the admissible ambient conditions.



If the temperature is subject to major fluctuations during transport, an acclimatization time of about 2 hours must be allowed before the device is installed and used. Always avoid condensation within the device, since this could adversely affect the internal parts or even destroy them.

### 5.2 Unpacking

Make certain the contents are not damaged. If damage has occurred, please contact the mail or shipping service and inform the supplier.-

Check the delivery, comparing your order with the delivery papers.

Save the original packaging in case the device needs to be placed in storage or shipped some time in the future.

If you have any questions, please contact Pepperl+Fuchs.

### 5.3 Mounting

	Do not aim the sensor at the sun. Protect the sensor from direct long-term exposure to sun. Prevent condensation from forming by not exposing the sensor to any major fluctuations in temperature. Do not expose the sensor to the effects of any aggressive chemicals. Keep the lenses and reflector of the device clean. Clean with a soft cloth, using standard commercial glass cleaner if necessary.
---	---

If existing adjustment and mounting options are to be used, M4 inserts can be pressed into the enclosure foot fixtures; to be ordered as an accessory (Page 9) Pos. 2.

The accessory OMH-LS610-01, a mounting bracket for attachment to walls, permits fast installation and adjustment.

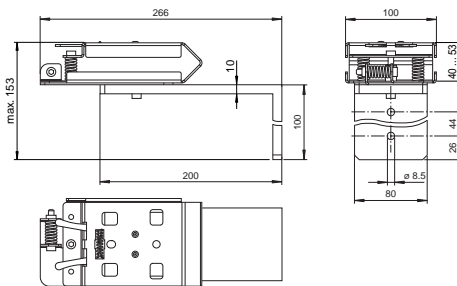

Figure 5.1: Mounting bracket OMH-LS610-01 for wall attachment

The mounting bracket (OMH-LS610-01) includes a pre-mounted adjustment device (X and Y direction). The mounting bracket can be used to set the required beam direction ( $\pm 90^\circ$  rotation); the two M4 screws and the M6 screws that are located in the middle of the bracket can be used to attach the mounting bracket. The center screw is used to attach the bracket after the adjustment has been completed.

To use the distance measurement device, press the two bars on the front with feet into the recesses in the adjustment device. The feet have to lock into place in so that the bars can be pressed to the outside up to the stop; if necessary the distance measurement device has to be pressed down applying some force from the top to the center.

### 5.3.1 Notes on Parallel Operation of Series VDM Devices and Optical Data Couplers

If series VDM devices and optical data couplers are operated at the same time in an optical axis, the following information must be observed to prevent the VDM from interfering with data transfer.

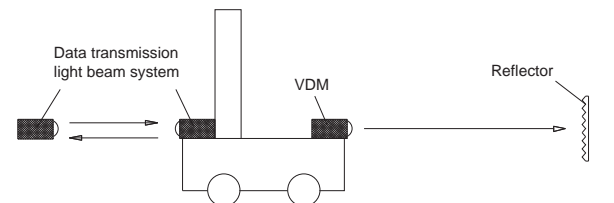

diagram 1

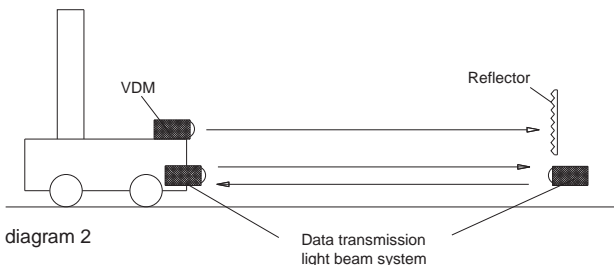

diagram 2

Figure 5.2: Arrangement of the devices

Issue date 21.09.2010 Part no. 206908

1. Normally we recommend an arrangement as shown in Figure 5.2 (1). Data transfer and distance measurement take place on two different sides of the vehicle. Take care to ensure the optical data coupler on the left side of the screen is not receiving any scattered light from the VDM. In most cases this presents no problem, since the vehicle blocks scattered light. This arrangement of devices is preferred for that reason.
2. If data transfer and distance measurement both take place on one side of the vehicle as shown in (2), the distance measurement may interfere with the data transfer if there is not enough space on the side. This happens because the foil reflector reflects the sharply focused beam of light under a larger dispersion angle and some of the reflected light makes its way into the receiving lens of the optical data coupler.

We therefore recommend always using a plastic reflector with low dispersion for this arrangement.

How much space is needed on the side between the optical data coupler and distance measurement device depends on the sensing range.

Distance	Distance a
30 m	0.5 m
60 m	0.8 m
90 m	1.0 m
120 m	1.2 m
240 m	2.4 m
300 m	3.2 m

Table 5.3: Relationship between distance and distance a

If the optical data coupler and distance measurement device are arranged as shown in (2), make certain that the beam of light from the VDM does not fall directly on the optical data coupler across from it.

## 5.4 Reflector selection

	Reflector 250 x 250	Reflector 500 x 500	Reflector 1000 x 1000	Reflector VDM01 (500 mm x 500 mm)	Reflector VDM02 (500 mm x 250 mm)
VDM100-50	Yes	Yes	Yes	Yes	Yes
VDM100-150	No	Yes, if VDM is stable	Yes	Yes	Yes
VDM100-300	No	No	No	Yes	Yes

Table 5.4: Reflector selection

The reflector VDM02 can only be used in conjunction with the reflector VDM01. The reflector VDM02 can be used as an extension to the VDM01. It serves only to intercept a possible migration of the measuring mark by means of unevenness or vibrations.

## 5.5 Reflector arrangement

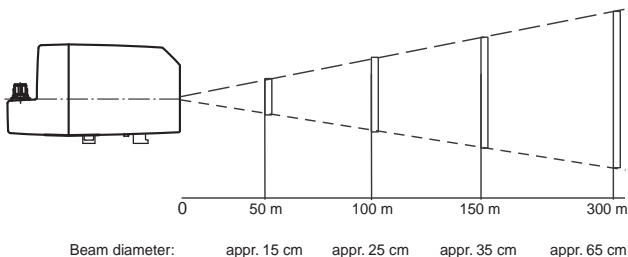

Figure 5.5: General reflector arrangement (side view of VDM)



Figure 5.6: Foil reflector arrangement (top view of VDM)

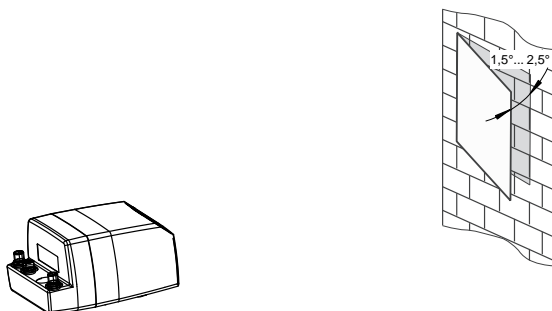

Figure 5.7: 3D view orientation of sensor alignment and required inclination of reflector

## 6 Commissioning

After the device is turned on, it enters an initialization phase of about 10 seconds. The red front LED (ERR) goes out as soon as the VDM100 has been correctly aligned to the reflector. The VDM100 is then ready for operation.

To achieve the best accuracy, allow a warm-up phase of 10 minutes.

The sensor has been tested and calibrated before delivery. It can be placed in operation immediately.

## 6.1 Connecting the Device

In order to ensure IP65 protection degree, the unused M12 connectors have to be fitted with protective caps, which can be ordered as accessories. (See Chapter 4.3)

The device is in conformity with protection class III. Please observe that the power supply has to be ensured by power packs, which supply low protective voltage (PELV). The grounding of the cable screens on the metal plug-in connectors is not a protective grounding suitable for protection of persons. It is simply a functional grounding (See Chapter 6.2). The power supply of the VDM100 is direct current 18 V - 30 V DC.

The VDM100 has two I/O connections that can be configured separately as an input or output. (See "I/O1 and I/O2" on page 19.). For inputs, an electrical level of  $U_e < 6\text{ V}$  is considered 'low' and a level of  $U_e > 16\text{ V}$  'high'. A connection configured as an output has a 'low' electrical level of  $U_a < 1\text{ V}$  and a 'high' level of  $U_a = U_B - 1\text{ V}$  at a maximum load of 200 mA, whereby  $U_B$  represents the supply voltage connected to the device. Both I/Os can be configured as a high active or a low active connection. The maximum cable length are 30 m.

The pin assignment of the plugs is as follows:

VDM100-SSI:

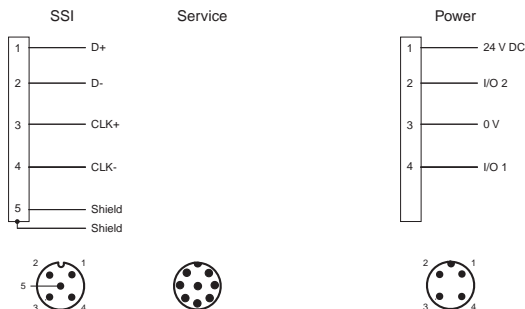

Figure 6.1: SSI interface pin assignment

VDM100-P:

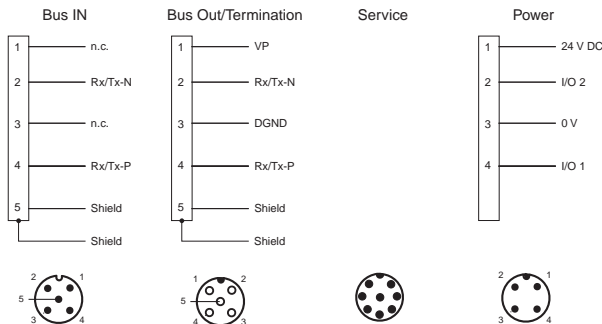

Figure 6.2: PROFIBUS DP interface pin assignment

VDM100-IBS:

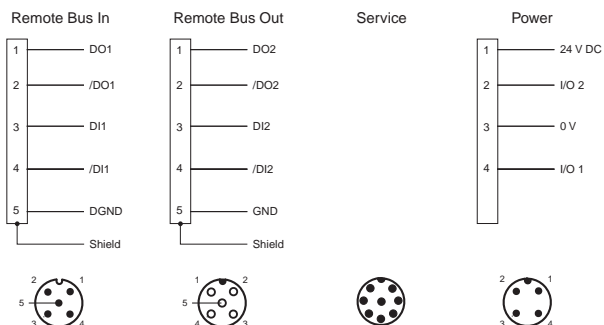

Figure 6.3: INTERBUS interface pin assignment

## 6.2 Grounding / Shielding

Functional grounding of the shields is recommended, since the housing does not allow for any grounding. If the shields need to be grounded for reasons related to EMC, Section 3.3.3 of the PROFIBUS PNO manual and the "Conformance test and certification V2.0" of the INTERBUS Club must be observed.

Please use the pre-mounted socket tongue for the screen grounding. The socket tongue is screwed to the bus link. The primary fastening nut of the plug-in connector must never be opened. If it is, the connecting assembly may be damaged and the housing may become leaky. The functional grounding can also be ordered as accessories. (see Chapter 4.3)



Figure 6.4: pre-mounted socket tongue

## 6.3 Adjustment

A clearly visible alignment laser pointer is located on the front of the device to assist with alignment. Using the alignment laser pointer, the distance measurement device can be optimally aligned to the reflector.

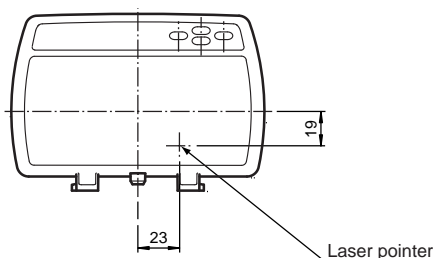

Figure 6.5: Alignment aid

### Alignment instructions

When making adjustments, make certain the laser pointer is positioned at an offset to the measurement optics. The adjustment, which must be made at maximum distance, works for both types of reflectors (foil and plastic reflectors). At greater distances, the adjustment must be made at a reflector distance of no less than 40 m.

Offset of the measurement beam to the laser pointer: Horizontal 23 mm and vertical 19 mm (Figure 6.5).

To monitor alignment, the laser pointer can be turned on permanently. An input must be configured accordingly (See "Laser pointer" on page 20.). If the sensor does not detect a target, the laser pointer will flash at a frequency of 1 Hz. When the sensor is aligned with the target, the laser pointer flashes for another 2 minutes and then switches off automatically. A test run with the laser pointer turned on serves to verify the position of the beam in dynamic operation.

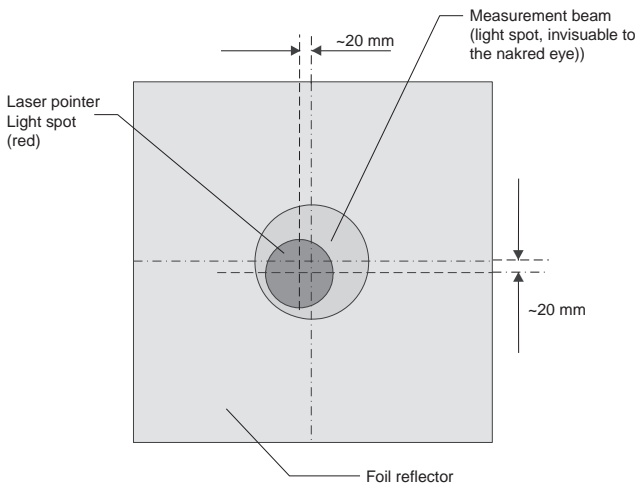

Figure 6.6: Alignment instructions

### 6.4 Display indication

The distance and the actual state of the two IO pins is displayed in "operation mode", regardless of whether the pin is used as an input or output. (See figure 6.7). A white box indicates "low" level and a black box indicates "high" level.

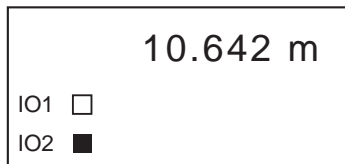

Figure 6.7: Illustration of the display in "operation mode"



## 7 Settings

### 7.1 Menu Structure

The following menu is available for setting operating states. Values that appear in **BOLD** type are default settings.

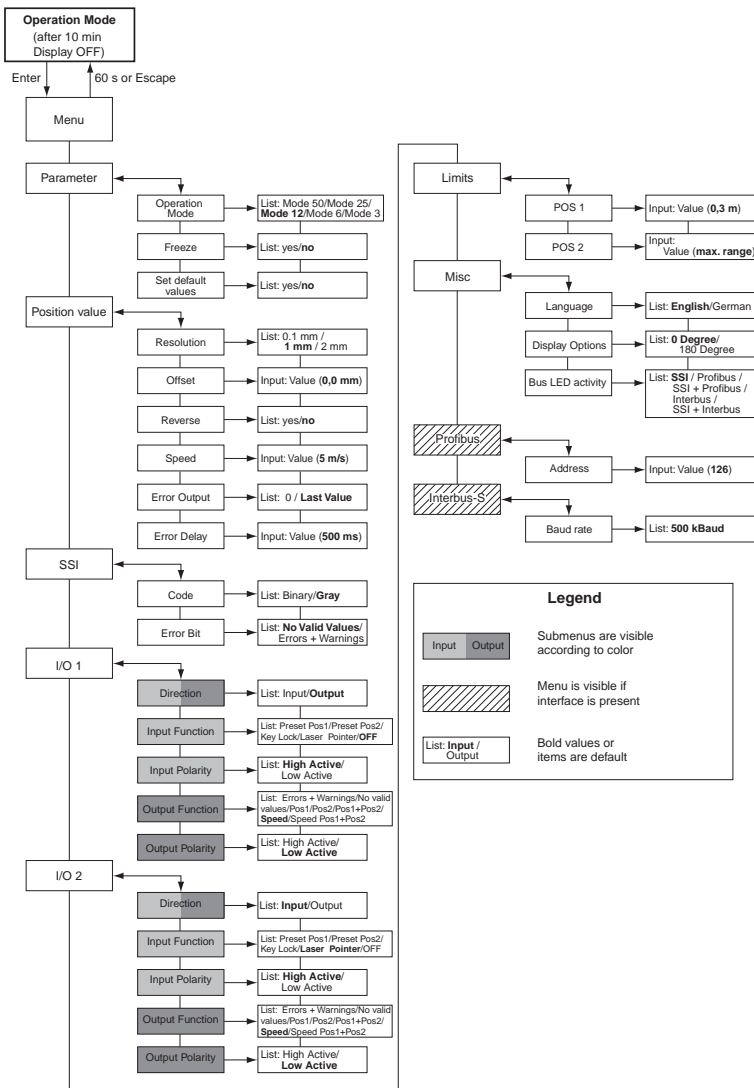

Figure 7.1: Menu structure

## 7.2 Description of menu items

### 7.2.1 Parameter

#### Operation modes

This setting is used to specify the age of the measured value output by the sensor. A measured value age of 50 ms, 25 ms, 12 ms, 6 ms and 3 ms can be configured. An increase in the age increases the accuracy of the measurement.

Operation mode	Measured value age	Measured value noise
Mode 50	50 ms	± 0.5 mm (1 sigma)
Mode 25	25 ms	± 0.7 mm (1 sigma)
Mode 12	12 ms	± 1.0 mm (1 sigma)
Mode 6	6 ms	± 1.4 mm (1 sigma)
Mode 3	3 ms	± 2.0 mm (1 sigma)

#### Freeze

The "Freeze" function turns off the noise of the output distance value when the sensor is deactivated. The measured value still remains active, but has a higher hysteresis depending on the noise factor.

#### Set default values

This menu item resets all device settings to their default values. If devices are fitted with a PROFIBUS interface, the PROFIBUS address is set to 126.

### 7.2.2 Position value

#### Resolution

This setting defines the resolution of the distance value output at the interfaces (SSI, INTERBUS, PROFIBUS). The resolutions 0.1 mm, 1 mm and 2 mm are available for selection. The device display is not influenced by this setting.

#### Offset

This value can be used to shift the zero point of the measurement so that several devices with different positions can be preset to the same distances. The absolute sensing range is not modified as a result. Valid offset settings fall within a range of -999.999 m to +999.999 m. The output measured value is calculated from the sum of the absolute measured value and the offset setting. This value is also used to verify the distance limits (See "Position1 / Position2" on page 21.).



- If the resulting measured value is negative, the device displays an error, in which case the offset should be increased.
- The offset is also used when the reverse function (See "Reverse" on page 18.) is activated.

#### Reverse

The reverse setting is used to invert the counting direction. The device displays 0 mm at maximum distance. If the distance decreases, the output value increases. The output measured value is calculated from the difference between the range limit (50 m on VDM100-50 and 150 m on VDM100-150) and the actual measured value.

### Speed

This menu item defines the speed at which the switch outputs are activated. (See "Speed" on page 20.)

### Error output

This option defines which distance value is issued in the event of an error. A value between '0' and the last valid measured value can be selected. If the 'last valid value' setting is selected and the device cannot detect a valid measured value, the value 999.999 m is output.

### Delay

This setting defines a delay time that the device waits until signaling an error via the error flag of the bus (SSI, INTERBUS, PROFIBUS) and a correctly configured switching output (See "Errors+Warnings" on page 20.). The error delay is specified in milliseconds.

## 7.2.3 SSI

### Code

The code of the distance value output by the SSI is defined in this menu. The selection options are digital code and gray code. The error flag is not influenced by the code (See Chapter 10.3.2).

### Error bit

This setting defines the behavior of the SSI error bit. The operator can select whether the setting should apply for error messages only (setting "No valid values") or error messages and warning messages (setting "Errors and warnings") (See "Error messages" on page 24.). This setting also applies to the collective bit field in the error byte of the PROFIBUS and INTERBUS.

## 7.2.4 I/O1 and I/O2

### Input / Output

This menu item allows the operator to select the functionality of the relevant I/O pin. The two I/O pins on the device can be configured as an input or an output independently of one another.

### Input: Function

The functionality of an input can be configured in this submenu, which only appears if the related I/O pin is configured as an input (See "Input / Output" on page 19.).

### Preset Pos1 / Preset Pos2

If a positive rising edge is increasing at the input pin, this function adopts the most current distance value as a limit value for position 1 or position 2 (See "Position1 / Position2" on page 21.).



When configuring via the PROFIBUS, pay attention to the 'Source for limit value position' flag (See Chapter 10.4.)

### Key lock

This function is used to prevent parameter changes via the HMI. A small lock symbol appears on the display in the corresponding submenu. The operator can continue to browse through the menu using the navigation keys.



The logical status of the input pin is always rated as high active regardless of the preset polarity of the input pin for the 'Key Lock' function, i.e., the input lock is activated if an actual high is present at the input.

### Laser pointer

With this function, an active input switches on the RLM (Red Laser Marker) as an alignment aid.



The logical status of the input pin is always rated as high active regardless of the preset polarity of the input pin for the 'Laser Pointer' function, i.e., the laser pointer is activated if an electrical high is present at the input.

### OFF

If this setting is active, a functionality is not assigned to the input. Changes to the state of the input pin are ignored.

### Input: polarity

This menu defines the transition between the physical state of the I/O connections and the logical evaluation.

For example: An input parameterized as low active is interpreted as inactive (logical '0') if the electrical level is 'High' ( $U_e > 16\text{ V}$ ) and active (logical '1') if the electrical level is 'Low' ( $U_e < 6\text{ V}$ ).

### Output: Function

The functionality of an output can be configured in this submenu. The menu only appears if the associated I/O pin is configured as an output (See "Input / Output" on page 19.)

### Errors+Warnings

If this setting is selected, the output becomes active (logical "1") when an error or warning appears on the display of the device.

### No valid values

If this setting is selected, the output become active if valid measured values are not available or are output via the interfaces.

### Pos1

If this setting is selected, the output become active if the (output) distance value is greater than the limit value entered for position 1 (See "Position1 / Position2" on page 21.).

### Pos2

If this setting is selected, the output becomes active if the (output) distance value is greater than the limit value entered for position 2 (See "Position1 / Position2" on page 21.).

### Pos1+Pos2

If this setting is selected, the output becomes active if the (output) distance value falls between the limit values entered for position 1 and position 2 (See "Position1 / Position2" on page 21.).

### Speed

If this output function is selected, the output is activated if the speed measured by the device exceeds the limit value defined under "Speed" on page 19.

### Speed pos. 1+2

If this setting is selected, the output becomes active if the current speed exceeds the limit value entered under "Speed" on page 19 while the device is outside of the distance values entered for position 1 and position 2 (See "Position1 / Position2" on page 21.).

### Output: polarity

This menu defines the transition between the physical state of the I/Os and the logical evaluation.

For example: An output parameterized as low active is set to electrical 'High' ( $U_a = U_B - 1\text{ V}$ ) when inactive and electrical 'Low' ( $U_a < 1\text{ V}$ ) when active.

## 7.2.5 Limit values

### Position1 / Position2

Two position limit values can be defined in these menu items. These values are evaluated by the functions that control the switching outputs (See "Speed" on page 20.).

## 7.2.6 Other

### Language selection

This setting defines the menu language. The settings German and English are currently available.

### Display option

The orientation of the display can be changed via this menu item. The display can be rotated 180° for overhead mounting applications. The key functions are also rotated 180°.

### Bus LED activity

This option controls the functionality of the green BUS LED. These LEDs indicate active data transfer to the selected bus. The following selection options are available:

SSI	Default setting for devices with SSI
PROFIBUS	Default setting for devices with PROFIBUS interface. Does not appear on other devices.
SSI + PROFIBUS	For devices with PROFIBUS interface only
INTERBUS	Default setting for devices with INTERBUS interface. Does not appear on other devices.
SSI + INTERBUS	For devices with INTERBUS interface only.



This submenu does not appear on SSI devices. The BUS LED is set to display SSI activity.

### 7.3 Operation

Distance and other parameters appear on a display in the front part of the VDM100. The distance and the actual state of the two IO pins are displayed in "operation mode" (See figure 6.7). A white box indicates "low" level and a black box indicates "high" level. Next to this display, there are 4 keys that can be used to navigate in the menu structure. Parameters can also be changed and values can be entered with these keys.

#### Meaning of the keys:

- ▷ - Jump to submenus, confirm value entries  
This key works like the ENTER key of a computer keyboard.
- ◁ - Jump out of submenus, undo an entry  
This key works like the ESC key of a computer keyboard.
- △ - Scroll up in a menu level
- ▽ - Scroll down in a menu level

Pressing the ▷ key takes you to the main menu level. These are all fields that are found under the "MENÜ" field in Chapter 7.1.

You can press the △ and ▽ keys to select the appropriate menu item (for example position). Pressing the ▷ key again takes you to the first submenu level. Depending on the selection, additional items appear here for selection or the user is prompted to enter a value (for example offset).

Two default values appear in each submenu. These values can be changed. However, please note explicitly that these values must only be changed by persons who have the necessary specialized technical understanding of the effects the change will have.

When numeric values are being entered, the processor checks continuously whether the relevant value is permissible. If an impermissible value is entered, the value cannot be saved and a corresponding message is generated.

If you mistype an entry, press the ◁ key several times to delete a number that has been entered or exit the relevant menu.

Negative values are permitted for the offset entry. This is necessary, for example, if the VDM100 had to be fastened at a greater distance but the interface should generate smaller values. If negative offset values that are too large are selected, they will result in a functional failure if the generated distance is less than "zero."

The VDM100 will not display negative distance values. In this case the error bit is set and the output remains set to zero.

Once all the settings have been made, you can return to "Operation Mode" with the ◁ key. If no key is pressed in the menu levels for 10 minutes, the display automatically jumps back to "Operation Mode."

## 7.4 FAQ

The error bit comes up frequently during the movement	The measurement beam strays while the reflector is moving
The ERR and TGT LED are on at the same time	The sensor has detected the target, but an additional error is present, for example the reflector distance is greater than the measurement range

Table 7.2: FAQ

## 8 Maintenance and Repair

### Maintenance

Observe the applicable national regulations for maintenance.

Basically, the sensor is maintenance free.

Nonetheless, check the technical safety of the sensor system at regular intervals, particularly watching out for damage to the housing.

Occasionally check the sensor for dirt or other contaminant buildup. To clean the sensor, use a dry or moist soft cloth to wipe the sensor at regular intervals. This action will ensure optimal function.

The housing is made of plastic. For this reason avoid contact with acetone and detergents containing solvents.

### Repair

If it seems likely that continued operation is no longer possible without danger, the sensor system must be taken out of operation and protected against unintentionally being placed in operation. Return the device to Pepperl+Fuchs for repair. Interventions and modifications are potentially hazardous, and any warranty and manufacturer's liability shall become void.

## 9 Fault elimination

### Installation Recommendations

- The sensor must be firmly mounted. It must not vibrate.
- The sensor must not be mounted behind a cover.
- The sensor should be mounted so it is protected from the rain.



When measuring insulation, make sure that the suppressor diodes have been installed for EMC stability.

### Error messages

Error message	Error description
No target	Measurement not possible. The sensor is not aligned correctly with the reflector or the echo is too weak. Please check the alignment of the sensor (See Chapter 6.3) and if necessary, clean dirt off the front panel and reflector.
Distance out of range	The reflector is outside the specified minimum or maximum limit for the distance measurement (See "Technical data" on page 25.). Please adjust the position of the reflector.
Negative distance value	The offset for the distance measurement is preset so that the resulting measured value is negative, which is not permitted. Please adjust the offset (See "Offset" on page 18.)
Maintenance	The sensor requires maintenance because the transmitting power of the laser is deteriorating. The sensor is still functional provided the error bit for warnings is deactivated (See "Error bit" on page 19.). Please contact Customer Service because the system will fail soon.
Calibration necessary	Internal reference measurement is at the tolerance limit. Stable measurement is no longer possible. Please contact Customer Service.
Calibration missing	Internal reference measurement is outside the tolerance limit. Measurement no longer possible. Please contact Customer Service.
Invalid parameter	The parameter lists in the sensor are invalid. Measurement is no longer possible. Please contact Customer Service.
No valid values	Measured values are outside the tolerances. Sensor defect. Please contact Customer Service.
Device error	The measured values are physically impossible. Sensor defect. Please contact Customer Service.

Table 9.1: Error messages

Part no. 206809  
21.09.2010

Issue date



## 10 Appendix

### 10.1 Technical data

<b>General data</b>	
Light source	Laser diode
Approvals	CE, cULus
Laser nominal ratings	
Note	Visible and invisible laser radiation, do not stare into beam
Laser class	Measurement laser: 1 Alignment laser: 2
Wave length	Measurement laser: 905 nm Alignment laser: 660 nm
Beam divergence	Measurement laser: 2 mrad Alignment laser: 1 mrad
Pulse length	Measurement laser: 4 ns
Repetition rate	Measurement laser: 20 kHz
Maximum optical power output	Alignment laser: 0.6 mW
max. pulse energy	Measurement laser: 12 nJ
Measuring method	Pulse Ranging Technology (PRT)
Maximum travel speed	15 m/s
Measurement range	VDM100-300: 0.3 ... 300 m VDM100-150: 0.3 ... 150 m VDM100-50: 0.3 ... 50 m
Reference object	VDM100-300: Reflector VDM01 VDM100-150: Foil reflector 500 mm x 500 mm VDM100-50: Foil reflector 500 mm x 500 mm
Type of light	905 nm IR light
Service life	> 100000 h
Diameter of the light spot	VDM100-300: < 70 cm at 300 m VDM100-150: < 35 cm at 150 m VDM100-50: < 15 cm at 50 m
Beam divergence	≤ 2 mrad
Extraneous light limit	> 100000 Lux
Resolution	0.1 mm, adjustable
Temperature effect	0.03 mm/K
<b>Display/controls</b>	
Function display	4 LEDs
Operating elements	Operating panel (4 keys) for adjusting parameters

Parameterization display	Illuminated display for measured value display and parameterization
<b>Electrical data</b>	
Operating voltage $U_B$	18 ... 30 V DC
Operating current	250 mA (18 V) ... 150 mA (30 V)
Protection class	III (rated voltage 50 V)
Time delay before availability $t_v$	< 10 s (-30 °C after 5 min.)
<b>Inputs / Outputs</b>	
Switching current	200 mA per output
Input/Output type	2 PNP inputs/outputs, independent configuration, short-circuit protection, reverse polarity protection
Input switching threshold	low: $U_e < 6$ V high: $U_e > 16$ V
Output switching threshold	low: $U_a < 1$ V high: $U_a > U_B - 1$ V
<b>Measurement accuracy</b>	
Measured value output	1 ms
Average measured value age	3 ms, 6 ms, 12 ms, 25 ms, 50 ms, adjustable
Offset	max. 2 mm (between two devices)
Absolute accuracy	$\pm 2.5$ mm (> 3 m), $\pm 3.5$ mm (0.3 m ... 3 m)
Repeatability	< 0.5 mm
<b>Conformity</b>	
Standards	EN 61326-1:2006; EN 60947-5-2:2007; IEC 60825-1:2007
<b>Ambient conditions</b>	
Ambient temperature	-10 ... 50 °C (263 ... 323 K) Version /146: -30 ... 50 °C (243 ... 323 K)
Storage temperature	-20 ... 70 °C (253 ... 343 K) Version /146: -30 ... 70 °C (243 ... 343 K)
Relative humidity	95%, no condensation
<b>Mechanical data</b>	
Degree of protection	IP65
Connection	M12x1 quick disconnect, 4-pin, standard (supply), M12x1 quick disconnect, 5-pin, B-coded, M12x1 quick disconnect, 5-pin, B-coded, M12x1 quick disconnect, 8-pin, service

Issue date 21.09.2010 Part no. 206809

Material	
Enclosure	ABS / PC
Light exit	PMMA, hard coated
Mass	approx. 700 g

*Specifications at 23 °C air temperature, 977 hPa and minimum switch-on duration of 30 minutes*

*With version /146 at -30 °C the minimum duty cycle is 90 minutes*

Table 10.1: Technical data

#### 10.1.1 SSI interface:

<b>Interface</b>	
Interface type	SSI
Readout rate (max.)	4000/s (SSI) Pulse frequency 100 kHz ... 1 MHz

Table 10.2: Technical data of SSI interface

#### 10.1.2 INTERBUS interface:

<b>Interface</b>	
Interface type	INTERBUS
Transfer rate	500 kBit/s

Table 10.3: Technical data of INTERBUS interface

#### 10.1.3 PROFIBUS DP interface:

<b>Interface</b>	
Interface type	PROFIBUS DP
Transfer rate	9.6 bit/s, 19.2 kbit/s, 93.75 kbit/s, 187.5 kbit/s, 500 kbit/s, 1.5 Mbit/s, 3 Mbit/s, 6 Mbit/s, 12 Mbit/s, adjustable

Table 10.4: Technical data of PROFIBUS DP interface

## 10.2 Model numbers

Photoelectric distance measurement devices	Sensing range	Model number
with SSI Interface	0.3 ... 50 m	VDM100-50-SSI
with SSI Interface and expanded Temperature range -30 °C	0.3 ... 50 m	VDM100-50-SSI/146
with SSI Interface	0.3 ... 150 m	VDM100-150-SSI
with SSI Interface and expanded Temperature range -30 °C	0.3 ... 150 m	VDM100-150-SSI/146
with SSI Interface	0.3 ... 300 m	VDM100-300-SSI
with INTERBUS interface	0.3 ... 50 m	VDM100-50-IBS
with INTERBUS interface	0.3 ... 150 m	VDM100-150-IBS
with INTERBUS interface	0.3 ... 300 m	VDM100-300-IBS
with PROFIBUS interface	0.3 ... 50 m	VDM100-50-P
with PROFIBUS interface and expanded Temperature range -30 °C	0.3 ... 50 m	VDM100-50-P/146
with PROFIBUS interface	0.3 ... 150 m	VDM100-150-P
with PROFIBUS interface and expanded Temperature range -30 °C	0.3 ... 150 m	VDM100-150-P/146
with PROFIBUS interface	0.3 ... 300 m	VDM100-300-P

Table 10.5: Model numbers



### 10.3.3 INTERBUS

INTERBUS has automatic successor detection. The successor is detected if it has an active bus when the power is turned on. If the successor does not become active until later, it is not detected automatically. In that case a software reset must be triggered.

The shield must be attached on both sides. The input (REMOTE BUS IN) is completely potential-free to the operating voltage and output (REMOTE BUS OUT). The output shield should be laid to PE (ground).

If the IN and OUT shields are connected, they must be laid to PE (ground) and a 10 mm<sup>2</sup> potential compensation must also be laid in parallel.

**Data telegram:**

Byte 0								Byte 1								Byte 2								Byte 3							
Bit	Bit	Bit	Bit	Bit	Bit	Bit	Bit	Bit	Bit	Bit	Bit	Bit	Bit	Bit	Bit	Bit	Bit	Bit	Bit	Bit	Bit	Bit	Bit	Bit	Bit	Bit	Bit	Bit	Bit	Bit	Bit
7							0	7							0	7							0	7							0
Error								Distance high								Distance middle								Distance low							

Table 10.8: INTERBUS data telegram

4 bytes are transferred digitally (1 error byte and 3 measurement value bytes). Bit 0 in the error byte is used as the error bit.

### 10.3.4 PROFIBUS DP

The last PROFIBUS node must be terminated with terminating resistors. To do this, screw the PROFIBUS termination (see Chapter 4.3) onto the termination connection. An address can be allocated via the PROFIBUS interface or the display. The default address is 126.



The VDM100 supports the PROFIBUS functionality "Freeze mode" whereby the measured value in the bus is no longer updated. This functionality should not be confused with the "Freeze" option in the VDM100 menu (see 1.2)

**Data telegram:**

Low byte								Middle byte								High byte								Error byte								Inputs							
0								1								2								3								3							
Bit	Bit	Bit	Bit	Bit	Bit	Bit	Bit	Bit	Bit	Bit	Bit	Bit	Bit	Bit	Bit	Bit	Bit	Bit	Bit	Bit	Bit	Bit	Bit	Bit	Bit	Bit	Bit	Bit	Bit	Bit	Bit								
7							0	7							0	7							0	7							0								
Distance low								Distance middle								Distance high								Error Error: Bit 0 = 1								Inputs: Bit 0 = IO1 Bit 1 = IO2							

Table 10.9: PROFIBUS data telegram

The shield must be attached on both sides. 5 bytes are transferred digitally (3 measured value bytes (M\_low, M\_middle, M\_high), 1 error byte and 1 input byte). Bit 0 in the error byte is used as the error bit. The input byte is switched as follows (switching outputs of the VDM100): Bit 0 = IO1 (= pin 4) and bit 1 = IO2 (= pin 2).

### 10.3.5 Error byte for PROFIBUS and INTERBUS

The error byte is composed of individual error bits, which specify the status of the sensor. Please refer to the following table for details of bit assignment. A more detailed description of the error states is included in Section "Error messages" on Page 24.

Bit	Meaning
0	Collective fault: If one of the following bits 1 - 6 ("No valid values") or bits 1 - 7 ("Error+Warnings") is set, this bit is set in line with the SSI error bit setting (see Page 19).
1	Fault: "No target"
2	Fault: "No valid values" or "Sensor faulty"
3	Fault: "Distance out of range"
4	Fault: "Calibration missing" or "Calibration necessary"
5	Fault: "Negative distance value"
6	Fault: "Invalid parameter"
7	Warning: "Maintenance"

Table 10.10: Error byte for PROFIBUS and INTERBUS

#### 10.4 Information on the GSD file (PROFIBUS DP)

You can modify the VDM100 user parameters using the master program based on the GSD file P&F\_0B6A. The values specified correspond to the factory default values, which are printed in **bold** in the table below.

The HMI switch "Use bus LED" cannot be accessed via the PROFIBUS parameterization.

Parameter	Selection list	Description	Additional information
<b>Scaling</b>	0.1 mm <b>1 mm</b> 2 mm	Measured value resolution for distance data output (identical for all interfaces)	
<b>Measured value in event of fault</b>	<b>Last valid value</b> 0	Output value when measuring error (no target) occurs	After the power is switched on or hardware errors occur, the incorrect value 0 x FFFFFFFF is output during internal initialization
<b>Counting direction</b>	<b>Forwards</b> Backwards	Direction selected for measured value output -> larger distances result in larger measured values -> larger distances result in smaller measured values	If "backwards" is selected, the range limit is automatically added to the offset
<b>SSI code</b>	<b>Gray</b> Digital	Code selected for the SSI interface measured value fraction	The error bit is not coded
<b>SSI error bit</b>	<b>No valid values</b> Errors & warnings	Defines the functionality of the SSI error bit (See "Error bit" on page 19.)	
<b>Noise suppression</b>	<b>Off</b> On	Suppression of measured value noise when the vehicle is at a standstill	Even if the vehicle has stopped completely, a small amount of measured value noise still occurs and sporadically changes the output value
<b>Source for limit value position</b>	<b>Parameters of PROFIBUS master</b> Measured value when input active	Defines how the limit positions are set. -> set permanently by the PROFIBUS master -> measured value at the moment when the input switches to active	Input function must be configured accordingly
<b>Measured value age</b>	50 ms 25 ms <b>12 ms</b> 6 ms 3 ms	Measured value delayed due to internal averaging	Greater averaging depth reduces noise

Part no. 206809  
21.09.2010  
Issue date



Parameter	Selection list	Description	Additional information
<b>Offset [mm]</b>	-999.999mm ... +999.999mm  <b>Default setting 0</b>	Shifts the zero point of the device by the required value in a positive or negative direction. Always entered in mm, regardless of the measured value scaling.	If the sum of the measured value and the offset is negative, the error bit is set and the output value remains zero.
<b>IO1 configuration</b>	Input <b>Output</b>	Functionality of the IO1 pin (pin 4)	
<b>I1 polarity</b>	Low active <b>High active</b>	Input polarity low or high active	Low: $U_e < 6\text{ V}$ High: $U_e > 16\text{ V}$
<b>I1 function</b>		Selection of input function	
	Set position 1	At the active edge, the current measured value is adopted as pos1/2	
	Set position 2		
	Key lock	The operating elements are locked if the input is active	
	Marking laser	The marking laser is switched on permanently if the input is active	
<b>No function</b>			
<b>O1 polarity</b>	<b>Low active</b> High active	Output polarity low or high active	Low: $U_a < 1\text{ V}$ High: $U_a > U_B - 1\text{ V}$
<b>O1 function</b>		Output active if	
	Errors & Warnings	Errors or warnings	
	Measured value invalid	Invalid measured value	
	Location > position 1	Position 1 exceeded	
	Location > position 2	Position 2 exceeded	
	between Pos1 and Pos2	Pos1 < measured value < Pos2	
	Maximum speed exceeded	the limit speed was exceeded at any point.	
	Max. V outside [Pos 1, Pos 2]	the limit speed is exceeded out of [Pos1, Pos2]	
<b>Identical function are available for the IO2=Pin 2</b>			
<b>Limit value position 1/2 [mm]</b>	0 ... 999.999mm  <b>Default setting</b> P1 = 300 mm P2 = 150.000 mm	Independent default values are compared internally with the output value (= measured value + offset) and the result of the comparison is applied to the outputs.	Positive values permitted only!

Parameter	Selection list	Description	Additional information
<b>Limit speed</b> [0.1 m/s]	1 ... 150	Limit value specification for internal speed measurement. The result of the comparison can be applied to the outputs and also linked to the limit positions.	Corresponds to 0.1 ... 15.0 m/s
<b>Error delay</b> [ms]	0 ... 9999 <b>Default setting</b> <b>500 ms</b>	Delay in the signalization of a measurement error via the interface error bits or the correctly configured output	
<b>Language selection display</b>	German <b>English</b>		
<b>Display option</b>	<b>0 degrees</b>		Also rotates the keyboard function 180°
	180 degrees	Rotates the image on the device display 180°	
<b>Default setting</b>	Default setting	Resets all parameters to their default settings	Sets the PROFIBUS address to 126
	<b>Customer setting</b>	The values set via PROFIBUS parameterization are adopted when the PROFIBUS activates the device.	The PROFIBUS overwrites the device settings modified via the HMI.

Table 10.11: Information on the GSD file



Part No. 206809

09/21/2010

Date of issue

With regard to the supply of products, the current issue of the following document is applicable:  
The General Terms of Delivery for Products and Services of the Electrical Industry, published by the Central Association of the Electrical Industry (Zentralverband Elektrotechnik und Elektroindustrie (ZVEI) e.V.) in its most recent version as well as the supplementary clause: "Expanded reservation of proprietorship"

# FACTORY AUTOMATION – SENSING YOUR NEEDS



## Worldwide Headquarters

Pepperl+Fuchs GmbH  
68307 Mannheim · Germany  
Tel. +49 621 776-0  
E-mail: [info@de.pepperl-fuchs.com](mailto:info@de.pepperl-fuchs.com)

## USA Headquarters

Pepperl+Fuchs Inc.  
Twinsburg, Ohio 44087 · USA  
Tel. +1 330 4253555  
E-mail: [sales@us.pepperl-fuchs.com](mailto:sales@us.pepperl-fuchs.com)

## Asia Pacific Headquarters

Pepperl+Fuchs Pte Ltd.  
Company Registration No. 199003130E  
Singapore 139942  
Tel. +65 67799091  
E-mail: [sales@sg.pepperl-fuchs.com](mailto:sales@sg.pepperl-fuchs.com)

[www.pepperl-fuchs.com](http://www.pepperl-fuchs.com)

 **PEPPERL+FUCHS**  
SENSING YOUR NEEDS

Subject to modifications  
Copyright PEPPERL+FUCHS • Printed in Germany

DOCT-1452C

206909  
06/2010