

Technical Data	
Functional principle	Microwave module
Detection speed	Min. 0.1 m/s
Marking	CE
Inclination angle	0 – 40° in 5° steps
Detection range	At 2200 mm installation height and 30° inclination angle: Width: 4500 x 2000 mm (WxD) Narrow: 2000 x 4500 mm (WxD)
Operating frequency	24.15 GHz – 24.25 GHz K band NA version (FCC/IC): 24.075 GHz – 24.175 GHz K band
Operating mode	Radar motion sensor
Function indicator	Red/green LED
Operating elements	Potentiometer and programming button for setting: switching mode, fall time, response time, disturbance reaction, size of detection area, addressing
Operating voltage	12 – 36 V DC/12 – 24 V AC
No-load current	< 50 mA at 24 VDC
Power consumption	< 1 W
Switching mode	Active/passive
Signal output	Relay, 1 NO contact/NC contact
Switching voltage	Max. 48 VAC / 48 VDC
Switching current	Max. 0.5 AAC/1 ADC
Switching power	Max. 24 W/60 VA
Fall time	0.2 s – 10 s, adjustable (factory setting 1 s)
Ambient temperature	-20° C to 60° C/248 – 333 K
Relative humidity	Max. 90 % without condensation
Mounting height	Max. 4000 mm
Degree of protection	IP 54
Connection	4-pin plug-in screw terminals, 5 m connection cable included in scope of delivery
Housing material	ABS, anthracite
Mass	120 g
Transmitting power (EIRP)	< 20 dBm
Dimensions excluding securing parts	123 mm (w) x 65 mm (h) x 57 mm (d)

Troubleshooting	
Fault	Corrective action
Door is detected.	Decrease the size of the detection area. Change the inclination angle.
LED not lit up.	No power supply, device not functioning.
Sensor reacts to the slightest influences such as rain, vibrations, or reflections. Door opens for no apparent reason.	Increase immunity, decrease the size of the detection area.
Potentiometer does not respond.	Operation with remote control is switched on. Switch off the remote control mode.
Remote control does not respond.	Operation with button and potentiometer is set. Switch on device addresses. Device is locked. Switch the operating voltage off and on again. The sensor can now be configured without a code for 30 minutes. Check the remote control battery.

Factory Settings	
Function	Setting
Detection area size	9
Relay contact	NO contact
Fall time	1 s
Responsiveness	Fast
Immunity	1 (minimal)
Address	1

Conformity with Standards

EU conformity: Pepperl+Fuchs Group hereby declares that the radio system types RMS-M and RMS-M-RC comply with Directive 2014/53/EU. The full declaration of conformity is available at www.pepperl-fuchs.com.

US conformity: The product RMS-M-NA is compliant with Part 15 of the FCC regulations.

Canada conformity: The product RMS-M-NA contains an IC-approved component.

IMPORTANT! The EU-compliant devices must not be marketed in the United States/Canada and the US/Canada-compliant devices must not be marketed in Europe!

Accessories	
RMS Weather Cap	Mounting set and weather protective cover

World Headquarters
Pepperl+Fuchs Group - Lilienthalstrasse 200
68307 Mannheim, Germany
Email: FA-info@de.pepperl-fuchs.com

USA Headquarters
Pepperl+Fuchs, Inc. Twinsburg, USA
Email: FA-info@us.pepperl-fuchs.com

Asia Pacific Headquarters
Pepperl+Fuchs Pte, Ltd. Singapore 139942
Email: FA-info@sg.pepperl-fuchs.com

www.pepperl-fuchs.com

DOCT-1703E
08/2022



Brief Instructions: Radar Motion Sensor for Detecting People at Automatic Doors

General information for your safety

This device must be installed and maintained only by qualified, trained personnel.

Observe the safety requirements of EN 60950-1. Operate the sensor only with an SELV supply with a limited output of up to 100 W. Use a T2.5 A fuse, for example, to reliably limit the power output.

Product Information

Scope of delivery

Quantity	Designation
1	Sensor RMS-M ...
1	Connection cable with plug
1	Self-adhesive drilling template
2	Screws for mounting
1	Mounting instructions

Operating elements

- ① Antenna
- ② Potentiometer
- ③ Terminal
- ④ Programming button
- ⑤ LED (red/green)
- ⑥ IR receiver (RC version only)
- ⑦ IR transmitter (RC version only)

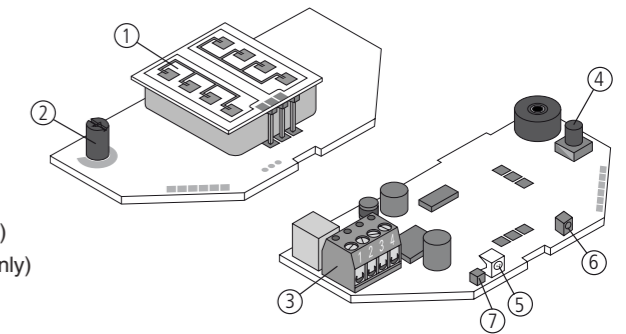

Installation

Opening the device

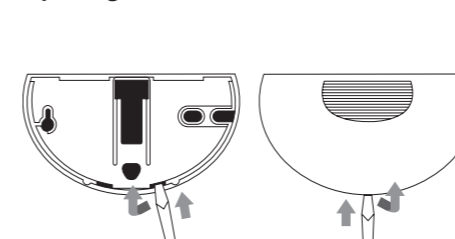

Open the housing from below:
Insert the screwdriver into the opening provided and carefully push open the cover.
Fold up and remove the cover.

Mounting the device

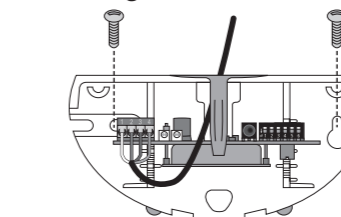

1. Attach the self-adhesive template and drill according to the markings on the template.
2. Pull the cable through the opening provided.
3. Fasten the base plate using the screws (screws are in the housing).

Connecting the radar

Connect the cable to the terminal as follows:

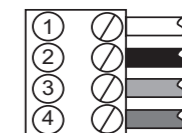

Connector assignment for RMS-M / RMS-M-RC

- ① AC/DC supply (white)
- ② AC/DC supply (black)
- ③ Relay contact 1 (red)
- ④ Relay contact 2 (green)

Connector assignment for RMS-M-NA

- ① AC/DC supply (red)
- ② AC/DC supply (black)
- ③ Relay contact 1 (white)
- ④ Relay contact 2 (green)



For RMS-M-NA:
To meet UL508 requirements, a 2.5 A slow-blow fuse should be used between the device and the power supply



Do not open the housing from the top.



Can be mounted on the ceiling using the RMS Weather Cap (see accessories).

Replacing or turning the antenna

to change the antenna characteristics

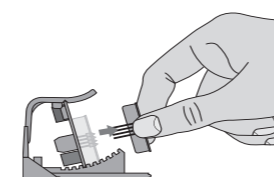

1. Select the size of the detection area.
2. Remove the antenna carefully using two fingers.
3. Turn the antenna through 90° or insert a new antenna.

Closing the device

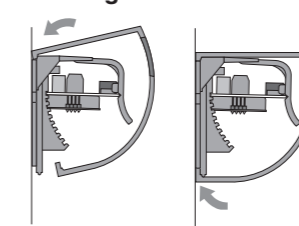

Attach the cover on the top and press down until it snaps into place.

Installation information

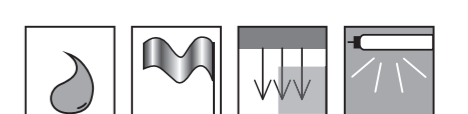

- Protect the radar from rain*.
- Avoid placing moving objects in the detection area (fans, plants, trees, flags).
- Do not cover the radar. Only install the radar behind appropriate covers. Mechanically operated drive components may affect the radar.
- Avoid fluorescent lights in the detection field.



Do not touch any electronic components. Do not use any metallic tools.



Before switching on the device, remove all objects from the door area that do not normally belong there.



*** Installation of the RMS Weather Cap is recommended (see accessories).**

Pepperl+Fuchs Group is certified according to ISO 9001.



For RMS-M, RMS-M-RC

Detection Field Settings

Antenna characteristics

A wide or narrow detection area can be set with the plug-in and rotatable antenna.

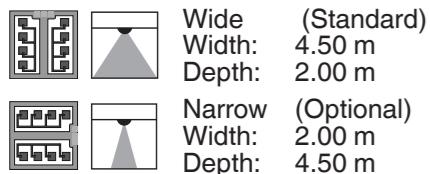

Installation height: 2.20 m
Inclination angle: 30°
Size of detection area: Max.

Inclination angle

You can change the position in 5° steps. To do so, hold the PCB at the side, turn toward the front and move to the required position. The default inclination angle is 15°.

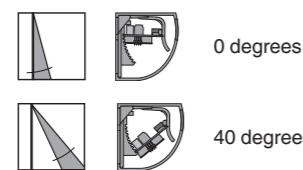

The PCB can also be inserted at an angle, up to 3 notches to the right or left. Notches can also be removed.



Immunity

Immunity can be used to minimize interference such as rain, vibrations, and reflections.

LED Status Indicator

Color indicator	Status
Green	Device ready for operation
Red	Detection active
Green flashing	Command received
Red flashing	Fault
Red/green flashing	Initialization after switching on

Some installation situations may limit the adjustment options and the functions of the sensor.

Detection area size

Change the size of the detection area using the potentiometer.



Min. 50 %
Max.

Programming with Button and Potentiometer

The sensor is programmed with the programming button and potentiometer. Use the programming button to activate the programming mode and confirm your settings. Use the potentiometer to adjust functions and values. The LEDs indicate the individual settings by flashing.

For adjustment options, please refer to the table "Settings with pushbutton and potentiometer".

Every time you press the button, the setting is saved automatically. If no adjustment takes place within 10 minutes, the programming mode is automatically exited. The set values are saved.



The potentiometer is moved during programming. For this reason, make a note of the potentiometer position prior to programming, so that you can reset the sensitivity to the original value after programming has been completed.

Setting the function

> 2 s Press and hold the programming button for approximately two seconds. Programming mode is activated.

To set the function, select the relevant position on the potentiometer. The green LED flashes to indicate the selected function.

Setting the value

> 2 s Press and hold the programming button for approx. two seconds.

To set the value, select the relevant position on the potentiometer. The red LED flashes to indicate the selected value.

Confirming the settings

< 1 s Press the programming button for less than 1 second. The programming mode is exited. The settings are saved.

Programming example: Changing the relay fall time to 3.0 s

Function/setting	Action	LED
> 2 s	Press the programming button for two seconds to activate programming mode.	
	Set the potentiometer to the position 2 – 4. The green LED flashes twice to indicate the "fall time for output" function.	
> 2 s	Press the programming button for two seconds to set the fall time.	
	Set potentiometer to position 6. The red LED flashes seven times to indicate the value "3.0 seconds".	
< 1 s	Press the programming button for one second to end programming mode.	
	Reset the potentiometer to the original sensitivity value.	

Check the settings of the button and potentiometer by walking within range of the sensor

Function			Setting			Description
Relay contact	0 – 2	1x	Closing active Opening passive	0 – 5 5 – 10	1x 2x	Relay contact closes on detection (N. O.) Relay contact opens on detection (N. C.)
Fall time for output	2 – 4	2x	off 0.2 s 0.5 s 1.0 s 1.5 s 2.0 s 3.0 s 4.0 s 5.0 s 10.0 s	0 1 2 3 4 5 6 7 8 9	0x 1x 2x 3x 4x 5x 6x 7x 8x 9x	Off: Relay is not activated 0.2 s: Shortest fall time 10.0 s: Longest fall time
Responsiveness	4 – 6	3x	Fast Normal Slow Very slow	Select position in adjustment range 0 – 10 according to LED display	1x 2x 3x 4x	Fast: Sensor triggers earlier (high sensitivity) Slow: Sensor triggers later (low sensitivity)
Immunity	6 – 8	4x	Off Normal min	0 1 2 3 4 5 6 7 8 9 10	0x 1x 2x 3x 4x 5x 6x 7x 8x 9x 10x	Off: Immunity deactivated Min.: Lowest immunity Max.: Highest immunity
Device addresses (only RMS-M-RC)	8 – 10	5x	1 – 8	Select position in adjustment range 0 – 10 according to LED display	0x 1x 2x 3x 4x 5x 6x 7x 8x	Remote control mode deactivated Address 1 Address 2 Address 3 Address 4 Address 5 Address 6 Address 7 Address 8
Reset	10 s		Press and hold the programming button until the LED flashes green/red alternately for 10 seconds.			Reset to factory settings

Commissioning

Before switching on the device, remove all objects from the door area that do not normally belong there.

- Switch on the device and wait 10 s (LED flashes red).
- Test the settings by walking within range of the sensor.
- The red LED lights up when you are detected.