

MANUAL

ODT-MAC400-* /

ODT-MAC401-* /

ODT-MAC403-*

**Stationary reader for all
common 1D- and 2D-barcodes**

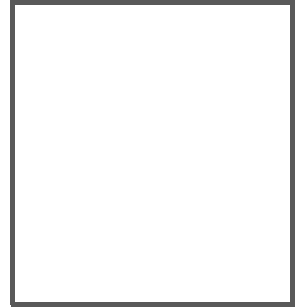

Laser Class 2M
EN 60825-1



With regard to the supply of products, the current issue of the following document is applicable: The General Terms of Delivery for Products and Services of the Electrical Industry, published by the Central Association of the Electrical Industry (Zentralverband Elektrotechnik und Elektroindustrie (ZVEI) e.V.) in its most recent version as well as the supplementary clause: "Expanded reservation of proprietorship"

1	Introduction.....	4
2	Declaration of conformity	5
3	Safety.....	6
3.1	Symbols relevant to safety	6
3.2	Intended use	6
3.3	General safety instructions	6
4	Product Description	8
4.1	Use and application of the ODT-MAC400-* / ODT-MAC401-* / ODT-MAC403-* -	8
4.2	Displays and controls	8
4.3	Interfaces and connections	9
4.4	Contents	10
4.5	Accessories	11
4.5.1	Cables	11
4.5.2	Other accessories	11
5	Installation.....	12
5.1	Preparation	12
5.2	Mounting.....	12
5.3	Connecting the device	13
5.4	Assigning an IP address to a network connection using Windows XP	14
5.5	Storage and transport	16
6	Commissioning.....	17
6.1	Connecting the stationary reader	17
7	Operation.....	18
7.1	Web-based operator interface.....	18
7.1.1	Settings Tab.....	20
7.1.2	Communication Tab.....	50
7.1.3	Tab Gallery.....	51
7.1.4	Dialog box Language	52
8	Troubleshooting.....	53
8.1	What to do in the event of an error	53
9	Appendix	54
9.1	Command format	54
9.2	Command overview	56
9.3	Input of nonprintable characters.....	61

1

Introduction

Congratulations

You have chosen a device manufactured by Pepperl+Fuchs. Pepperl+Fuchs develops, produces and distributes electronic sensors and interface modules for the market of automation technology on a worldwide scale.

Symbols used

The following symbols are used in this manual:



Note!

This symbol draws your attention to important information.



Handling instructions

You will find handling instructions beside this symbol

Contact

If you have any questions about the device, its functions, or accessories, please contact us at:

Pepperl+Fuchs GmbH
Lilienthalstraße 200
68307 Mannheim
Telephone: +49 621 776-4411
Fax: +49 621 776-274411
E-Mail: fa-info@pepperl-fuchs.com

2

Declaration of conformity

This product was developed and manufactured under observance of the applicable European standards and guidelines.



Note!

A Declaration of Conformity can be requested from the manufacturer.

The product manufacturer, Pepperl+Fuchs GmbH, D-68307 Mannheim, has a certified quality assurance system that conforms to ISO 9001.



3 Safety

3.1 Symbols relevant to safety



Danger!

This symbol indicates a warning about an immediate possible danger.

In case of ignoring the consequences may range from personal injury to death.



Warning!

This symbol indicates a warning about a possible fault or danger.

In case of ignoring the consequences may cause personal injury or heaviest property damage.



Caution!

This symbol indicates a warning about a possible fault.

In case of ignoring the devices and any connected facilities or systems may be interrupted or fail completely.

3.2 Intended use

The ODT-MAC4**-LD-RD-MC stationary reader is intended to be used only for the identification of objects by means of 1D- and 2D-codes.

Always operate the device as described in these instructions to ensure that the device and connected systems function correctly. The protection of operating personnel and plant is only guaranteed if the device is operated in accordance with its intended use.

3.3 General safety instructions

Class 2 laser product

This device is a class 2 laser product:



Standards

IEC 60825-1:2007 certified. Complies with 21 CFR 1040.10 and 1040.11 except for deviations pursuant to Laser Notice No. 50, dated 06-24-07.



Warning!

Visible red class 2 laser light

The irradiation can lead to irritation especially in a dark environment. Do not point at people!

Caution: Do not look into the beam!

Maintenance and repairs should only be carried out by authorized service personnel!

Attach the device so that the warning is clearly visible and readable.

Caution – Use of controls or adjustments or performance of procedures other than those specified herein may result in hazardous radiation exposure..

Only use recommended original accessories.

The operating company bears responsibility for observing locally applicable safety regulations.

Installation and commissioning of all devices must be performed by a trained professional only.

User modification and or repair are dangerous and will void the warranty and exclude the manufacturer from any liability. If serious faults occur, stop using the device. Secure the device against inadvertent operation. In the event of repairs, return the device to your local Pepperl+Fuchs representative or sales office.

4 Product Description

4.1 Use and application of the ODT-MAC400-* / ODT-MAC401-* / ODT-MAC403-* -

The stationary reader is an optical identification system for detection of up to 28 different code symbologies. With its high-performance signal processor, a partial image capture function, and optimized decoding algorithms, the device features extremely high reading speeds.

The stationary reading device can be configured easily and quickly using a normal web browser, via the standard Ethernet interface or a series connection. Support is also provided for the mechanical alignment of the reading device in the form of an integrated laser pointer and a connected VGA monitor. The reading device also features an integrated error image memory.

Typical areas of application are

- Document handling
- Printing machines
- Identification in the packaging and warehouse sector
- PCB identification

4.2 Displays and controls

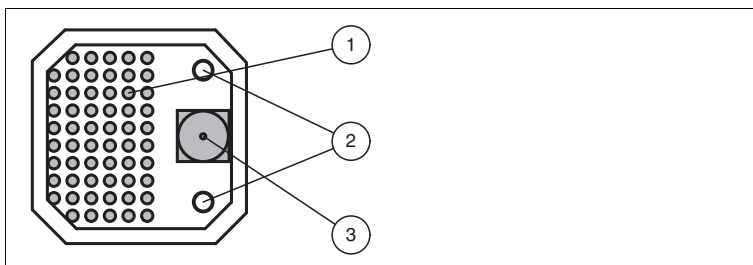

1. Lightning unit
2. Laser diodes
3. CMOS camera

The stationary reader ODT-MAC403-* does not have laser diodes.

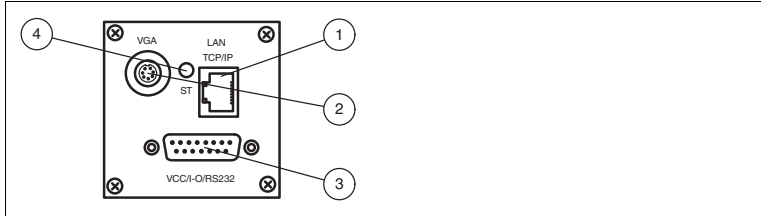

- 1 RJ45 Ethernet network socket
- 2 Video output VGA 640x480
- 3 15 pin D-Sub connector
- 4 Status LED

Status LED

LED color	Description
Yellow	The LED turns to yellow for a short time after switching on.
Green	The LED flashes green after a successful read (good read).
Red	The LED flashes red after an unsuccessful read (bad read).

4.3 Interfaces and connections

15-pin D-sub connector

PIN	Signal	Description
1, 2	GND	GND for device
3	IO GND	GND for inputs/ outputs
4, 5	+24 V	Supply for device, 24 V DC PELV $\pm 15\%$
6	IO +24 V	Supply for inputs/ outputs, 24 V DC PELV $\pm 15\%$
7	RTS	Handshake signal, RS 232
8	IN1	24 V DC input
9	IO-OUT0	24 V DC "good read" output
10	IO-OUT1	24 V DC "bad read" output
11	IO-IN0	24 V DC "trigger" input
12	CTS	Handshake signal, RS 232
13	TXD	Transmission line, RS 232
14	RXD	Receive line, RS 232
15	IN2	24 V DC input

Video output VGA 640x480 (7-pin cylindrical connector)

PIN	Signal	Description
1	OUT V _{sync}	Vertical synchronization output
2	GND RGB	Red signal, green signal and blue signal ground
3	OUT R	Red signal output
4	OUT G	Green signal output
5	GND	Horizontal synchronization output ground and vertical synchronization output ground
6	OUT B	Blue signal output
7	OUT H _{sync}	Horizontal synchronization output

Network connection

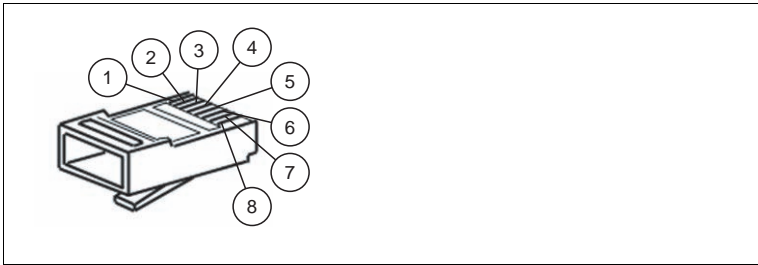

Figure 4.1 Network connection pin assignments

- 1 Transmit data (+)
- 2 Transmit data (-)
- 3 Receive data (+)
- 4 Not assigned
- 5 Not assigned
- 6 Receive data (-)
- 7 Not assigned
- 8 Not assigned

4.4

Contents

- ODT-MAC4**-LD-RD-MC
- Quick start guide

4.5 Accessories

Various accessories are available.

4.5.1 Cables

The following cables are available as accessories.

Model number	Description
ODZ-MAC-CAB-VIDEO	Video connection cable, cylindrical connector, 7-pin on SUB-D socket, 15-pin VGA, 2 meters
ODZ-MAC-CAB-15POL-2,5M-FEMALE	Connection cable, Sub-D socket, 15-pin, 2.5 meters, can be pre-assembled
ODZ-MAC-CAB-15POL-5M-FEMALE	Connection cable, Sub-D socket, 15-pin, 5 meters, can be pre-assembled
ODZ-MAC-CAB-24V-R2-2M	Connection cable for power supply, RS 232
V45-G-10M-V45-G	Network cable RJ45, category 5, up to 100 MHz, 10 m

4.5.2 Other accessories

Other products are available as accessories.

Model number	Description
ODZ-MAC-PWR-24V	Desk top power supply 24 V DC, 1.88 A

5 Installation

5.1 Preparation



Unpacking the unit

1. Check that all package contents are present and undamaged.
 - ↳ If anything is damaged, inform the shipper and contact the supplier.
2. Check that all items are present and correct based on your order and the shipping documents.
 - ↳ If you have any questions, please contact Pepperl+Fuchs.
3. Keep the original packing material in case you need to store or ship the unit at a later time.

5.2 Mounting



Note!

Preventing reflection and glare

Reflection and glare from reflective surfaces can impair the captured image and therefore lead to incorrect readings. To prevent reflection and glare, install the stationary reading device at a slight angle.

Please refer to the technical data in the data sheet for the read distance.

ODT-MAC400-*

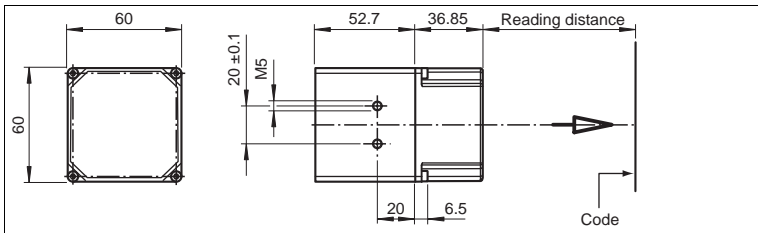

Figure 5.1 Dimensions of the **straight** housing

ODT-MAC401-*

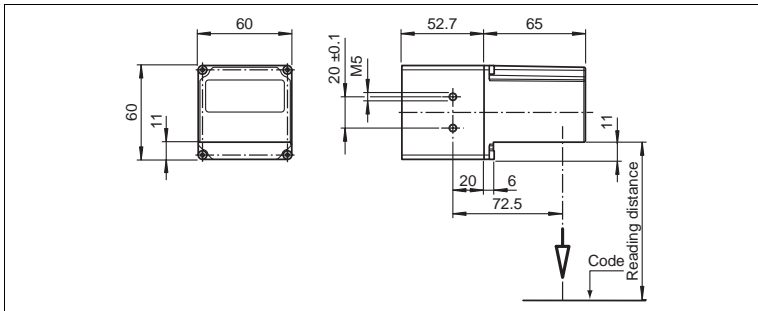

Figure 5.2 Dimensions of the **angle** housing

ODT-MAC403-*

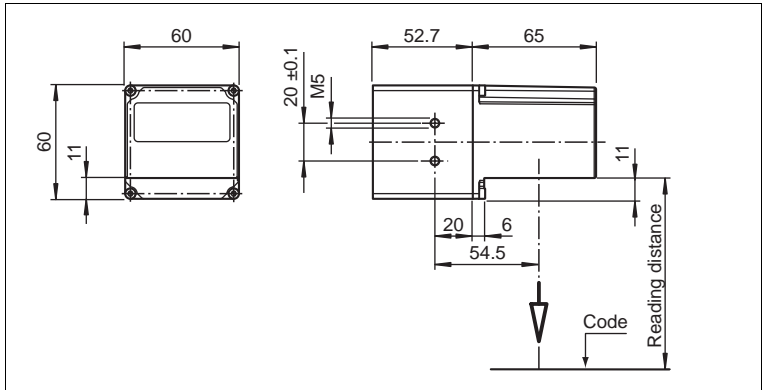

Figure 5.3 Dimensions of the **angle** housing



Note!

Connection to ground

When installing the device, ensure that it has a ground connection.

5.3

Connecting the device



Connecting the power supply

To connect a power supply to the device, proceed as follows.

1. Plug the 15-pin Sub-D socket into the connector provided for this purpose on the back of the housing.
2. Screw in the two mounting screws as far as possible.
 - ↳ This ensures that the cable cannot be inadvertently pulled out.
3. Next connect the power supply to the appropriate pins on the Sub-D socket.
 - ↳ The power supply has now been connected.

To connect the power supply to the device quicker, the pre-configured connection cable can also be used. Information can be found in the Accessories section.



Note!

Record the network configuration

The device communicates with the connected machine control system using the TCP/IP protocol. To ensure communication works correctly, you must note down all the changes you make to the network configuration.



Note!

Network cabling

Use a crossover network cable to connect the device directly to a PC. If the device is being operated within a network, use a twisted-pair network cable to connect it to the network.



Establishing a network connection

In order to establish a network connection, proceed as follows.

When delivered, the device has a fixed IP address (192.168.2.2). To facilitate communication within the network, you must configure your network. The configuration data can be found in the network configuration overview.



Connecting a trigger sensor

To connect a trigger sensor, proceed as follows.

Connect the trigger sensor to the cable previously connected for the power supply.

5.4

Assigning an IP address to a network connection using Windows XP



To assign an IP address to a network connection using Windows XP, proceed as follows.

1. First select **"Network Connections"**.

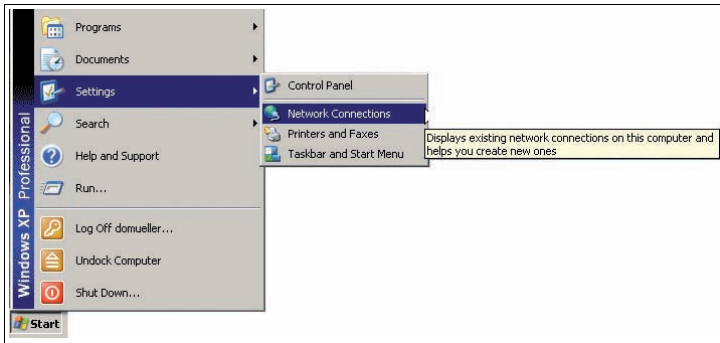

2. Then open the required connection by double clicking on it.

↳ The Properties dialog box for the relevant connection will open.

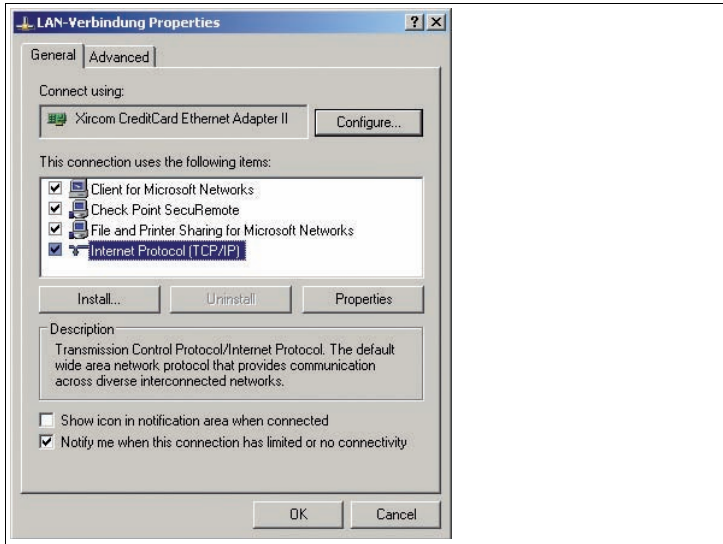

3. Select the **"Internet Protocol (TCP/IP)"** element from the Properties dialog box by double clicking on it.

↳ The TCP/IP properties dialog box will open.

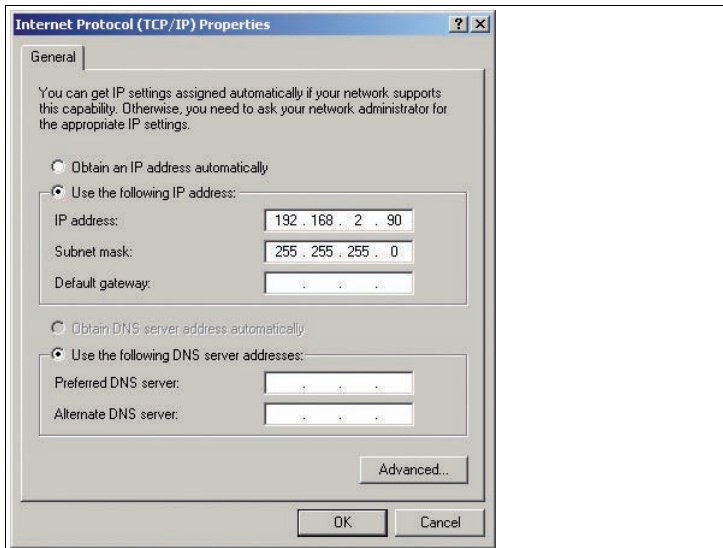

4. In the TCP/IP properties dialog box, activate **"Use the following IP address"**.

5. Enter an IP address which only differs from the sensor IP address in the very last segment.
6. Enter 255.255.255.0 as the subnet mask.
7. Then confirm your entries on the TCP/IP properties page and the LAN connection properties page using "**OK**" and "**Close**".

↳ This completes the network configuration and the sensor can be used.

5.5

Storage and transport

For storage and transport purposes, package the unit using shockproof packaging material and protect it against moisture. The best method of protection is to package the unit using the original packaging. Furthermore, ensure that the ambient conditions are within allowable range.

6 Commissioning

6.1 Connecting the stationary reader

The reader has its own web server. You have the option of making settings on the stationary reader using a standard web browser.



Aligning the stationary reader

To find the ideal alignment for the device, use the two laser diodes in the stationary reader.

1. Supply power to the reader via the D-Sub connector.
2. Adjust the stationary reader so that both points generated by the laser diodes are positioned on top of each other on the code to be read.

↳ This sets the ideal reading distance between the stationary reader and the code to be read.

7 Operation

7.1 Web-based operator interface

You have the option of configuring and operating the sensor via a web-based operator interface and using it to display information. The web-based user interface should be used only for setup and troubleshooting purposes when the machine is shut down.



Note!

To start the operator interface of the sensor, you need a standard web browser (e.g., Windows Internet Explorer or Mozilla Firefox) with Java script activated.

We recommend the following browser versions

Firefox	3.6.8 or higher	Communication between MAC and PC via LAN interface
Internet Explorer	6.0.2900.2180 or higher	Communication between MAC and PC via LAN interface



Starting the operator interface

To start the operator interface, proceed as follows.

In the input field of a standard web browser, enter the IP address of the stationary reader (**192.168.2.2**) and press return to confirm.

↳ The following tab opens as the start page: **Settings**.

The screenshot shows the 'Settings' page of the web-based operator interface. On the left is a navigation menu with 'Settings' selected. The main content area is titled 'Exposure Settings' and includes sliders for 'Flash duration' (set to 140 µs) and 'Sensor Gain' (set to 120). Below these are buttons for 'Load From Flash', 'Save To Flash', 'Command' (with a 'Send' button), and 'Reset counters' (with an 'Ok' button). A 'Decoder Settings' section is visible below. On the right side, there is a status panel for 'PEPPERL+FUCHS SENSING YOUR NEEDS' showing system information like SNFW (MC 00.03.89), MAC address (00-0D-81-00-14-47), and various error and trigger counts. It also features a 'Start Live Modus' button, a 'One Shot' button, a live image of a document, and a 'Code Data' field displaying 'DEA\0B\00\F6'. At the bottom of the status panel, it shows 'Total Symbols: 1', '1st Symbol: Data Matrix', 'Bytes in Symbol: 6', and 'Processing Time: 46'. The version number 'Version 110726' is visible in the bottom left corner of the interface.

The following four tabs can be found on the left-hand side of the display:

- Settings
- Communication
- Gallery
- Language

Various information is displayed in the central section—depending on which tab is active.

On the right-hand side, various status information (such as the software/firmware version, the MAC address, the number of reads, etc.) is displayed, as well as the last image captured and the decoded information. On the right of the Pepperl+Fuchs company logo there is a pictorial representation of a status LED. This status LED lights up green when a device is connected. Otherwise it is red.



Activating live image capture



Note!

By viewing the captured images on the operator interface during operation, the image refresh rate reduces significantly.

To activate live image capture, click the **Start Live Mode** button on the right-hand side of the display screen.

↳ The stationary reader starts to capture images. The captured images are displayed in the results window. The decoded information is displayed beneath it in a separate window.



Starting single image capture

On the right-hand side of the display screen, click on the button **Single image**.

↳ Clicking the button triggers a single image capture.

7.1.1

Settings Tab

The **Settings** tab enables you to configure various parameters and send commands to the sensor. In the left display area, you can navigate to the other tabs **Communication**, **Gallery** and **Language**.

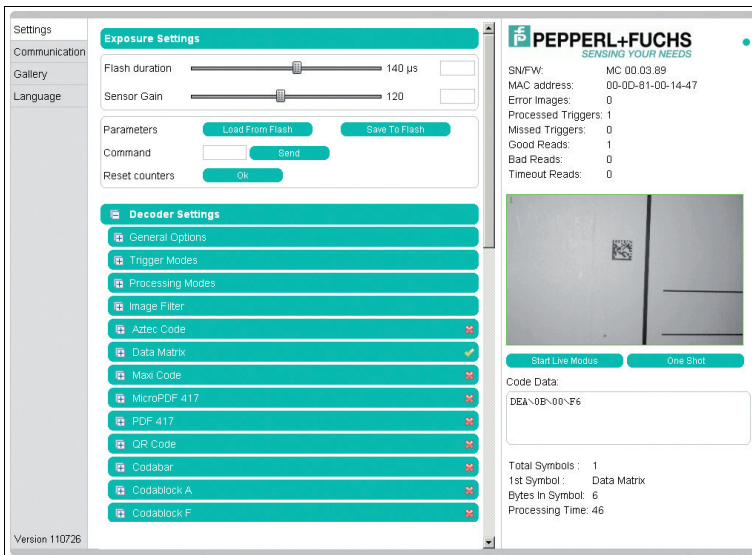

In the center of the screen, the following functions are available in different fields:

Sensor parameters

Settings	Explanation
Flash duration	This parameter is used to set the duration of the flash at intervals of 10 µs.
Gain	This parameter is used to set the electronic brightness gain. A high value electronically increases the brightness of the captured image and can improve the readability of the code considerably in the event of poor ambient conditions.
Parameter set	Load from Flash: Use this button to load parameter settings from the internal memory (Flash EEPROM). Save to Flash: Use this button to save your current parameter settings in the internal memory (Flash EEPROM).
Command	Send individual commands to the sensor.
Reset counter	The trigger counter value can be reset to 0 here.



Sending a command

You have the option of sending individual commands to the sensor. The commands are made up of 4-digit hexadecimal numbers (0 ... 9, A ... F). An overview of the available commands can be found in the appendix.

1. If you are not already on the **Settings** tab, navigate to it.
2. Enter a valid, 4-digit hexadecimal number for the required command in the **Command** field.

3. Click on **Send**.

↳ The relevant command will be sent to the sensor, where it will be executed.

Decoder parameters

Settings can be applied to the individual symbologies via the “Decoder parameters” menu option. The green checkmark and red cross show which symbologies have been activated and which have not. They can be activated or deactivated via the respective menus. You can configure settings to the general operating principle of the sensor via the **General settings** menu option.

General settings

- Any new values entered in a text box are sent to the reader automatically after approximately 1.5 seconds. Pressing the enter key is not absolutely required.
- If an invalid character is entered in a text box (e.g., a letter in a numerical field), the background is highlighted red and the value is not sent to the reader. If a value outside the validity range is entered, the background is also highlighted red.

The general settings for operation are entered here.

- **Trigger signal edge:** Configures the inputs for rising edge or falling edge
- **Triggers for edge/level (individual triggers only):** Configures the inputs for edge and level sensitivity
- **Decoder mode:** Configuration option of **automatic** or **assisted**. If the option **automatic** is selected, no defined distances between the reader and the code are adopted. If the option **assisted** is selected, a fixed read distance between the reader and code carrier is adopted (refer to the technical data in the data sheet for the read distance). This defines the size of the code. However, additional settings are required as a result (reading window width).
- **Contrast improvements:** The following options can be used to increase the detection reliability of codes and images with low levels of contrast. Either general linear codes (apart from Interleaved 2/5), just Interleaved 2/5, or both can be activated. Activating these options can result in longer decoding times and must be assessed on a case-by-case basis.
- **Average reading window width (mm):** The value range is 10 mm ... 200 mm. Input of the average reading window width.

- **Image mode:** How the code is to be read. If **mirrored** is selected, then the reader expects a mirrored code (read via a deviation mirror).
- **Select parameter file:** A backup file can be loaded into the sensor. Use the **Browse...** button to select the file and then load it into the sensor with the **Send** button.
- **Download parameter file:** The settings that you have made can be saved in a backup file.
- **Set default decoder parameters:** Resets all values to their default values.

Explanation of trigger signal edge and triggers for edge/level:

Trigger signal edge: The sensor responds to edges, i.e., signal changes (rising/falling edge) that are triggered by a photoelectric sensor.

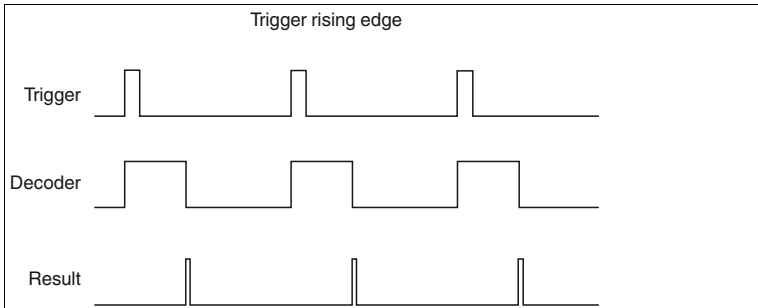

Figure 7.1 Pulse diagram trigger rising edge

Triggers for edge/level: The sensor responds to a pending level, which means it initiates synchronous trigger cycles as long as the signal is pending, i.e., image capture, decoding, image capture, decoding, image capture, decoding.

Automatic sensor start

If “Triggers for edge/level” mode is activated, it is possible for the sensor to start running automatically and trigger, if the trigger input wiring is connected permanently to High (or Low).

Procedure: Triggers for level active and single trigger mode active -> Trigger as long as level is High.

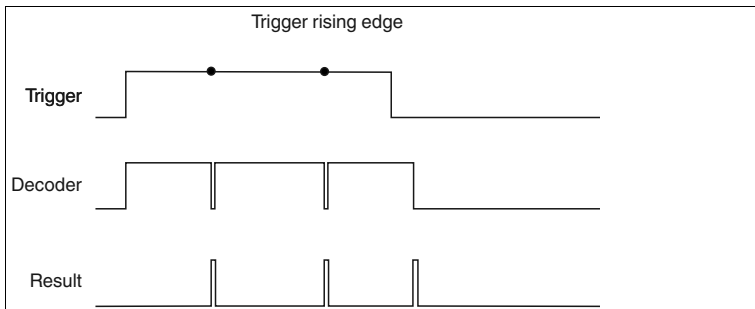

Figure 7.2 Pulse diagram trigger rising edge and level

General Options

Trigger signal edge:
 rising edge falling edge

Trigger on signal edge / signal level (Single trigger mode only)
 disable enable

Operation Mode:
 automatic assisted

Low contrast improvement:
 none linear symbols interleaved 2/5 linear symbols + interleaved 2/5

Average FOV (field of view) width: (10mm ... 200mm)

Image Mode:
 normal mirrored

Pick parameter file:

Figure 7.3 Decoder settings - General Options

Trigger modes

Under the Trigger modes menu item, you can select whether to process one or several triggers and specify how these triggers should be processed.

Trigger modes: Single trigger

In Single trigger mode, one image is captured and decoded for each external trigger. Any other triggers that arise during the decoding process are ignored. Activating the function **Permit asynchronous triggers** permits triggers during decoding.

- **Suppress unsuccessful read (RS232 & TCP/IP):** Specifies whether the output of the signal or output string from an unsuccessful read should be suppressed (activated) or not suppressed (deactivated).
- **Machine cycle:** Machine cycle setting. The value must be greater than 20 ms. The value specifies the time gap between each incoming external trigger (minimum time). The setting has an effect on the timeout.
- **Permit asynchronous triggers:** Specifies whether or not asynchronous triggers are permitted. If the field is activated, another trigger can be processed while a captured image is being processed.

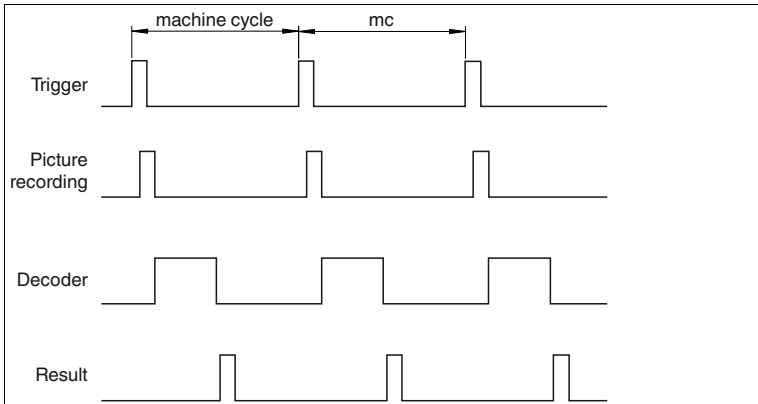
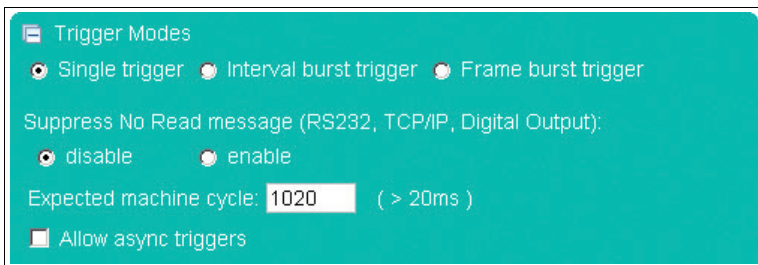

Figure 7.4 Pulse diagram single trigger



Trigger modes: Interval burst trigger

In Interval burst trigger mode, several images are captured and decoded for each external trigger. An interval is defined, during which several images are captured. The burst length and time limit define the minimum number of images or decoding attempts: $N = \text{burst length} / (20 \text{ ms} + \text{time limit})$. Any other triggers that arise during the burst are ignored and counted as missed triggers.

- **Suppress unsuccessful read (RS232 & TCP/IP):** Specifies whether the output of the signal or output string from an unsuccessful read should be suppressed (activated) or not suppressed (deactivated).
- **Burst length:** Burst length setting in ms. The value range is 0 ms ... 30000 ms. Entering the number 30001 is the equivalent of setting no limit, i.e., once the reader starts triggering, it carries on continuously. Continuous burst mode can be terminated by a command (8400) or pulse at the second input.
- **Decoder timeout:** Specifies the decoder timeout, between 10 ms and 10000 ms. Here, enter the maximum time that the decoder should attempt to decode a captured image.
- **Stop after good reading:** Specifies whether the burst is stopped after a good reading. If the burst length is set to infinite, the burst does not stop after a good reading.
- **Duplicate suppression (ms):** The value range is 0 ms ... 30000 ms. Here, enter the maximum time that the last decoding result should be ignored. Example: A code is ignored if it cannot be retrieved quickly enough from the read area and the same code is read again.
- **Gain hysteresis:** Activate or deactivate the gain hysteresis. The gain value hysteresis may be useful if the contrast of symbols scheduled for scanning is varied. The hysteresis can be deactivated or activated with ± 1 increment up to an increment quantity of ± 15 increments. When an increment width of 2 is entered, a total of 5 captures are triggered. Example: The gain is set to 100, the gain hysteresis is activated with 2 increments, and the increment width is set to 5, which means that when a trigger occurs, 5 images with the following gain values are captured in succession: 100, 105, 95, 110, 90. The preset gain value is the average value of the hysteresis, so to speak. (Note: The gain value range extends from 0 to 255. If the upper or lower limit is exceeded as a result of the hysteresis process, the relevant gain value is limited to 0 or 255. Example: Gain 50, 4 increments, increment width 20, -> gain values: 50, 70, 30, 90, 10, 110, 0, 130, 0). The gain hysteresis stops if decoding is successful.

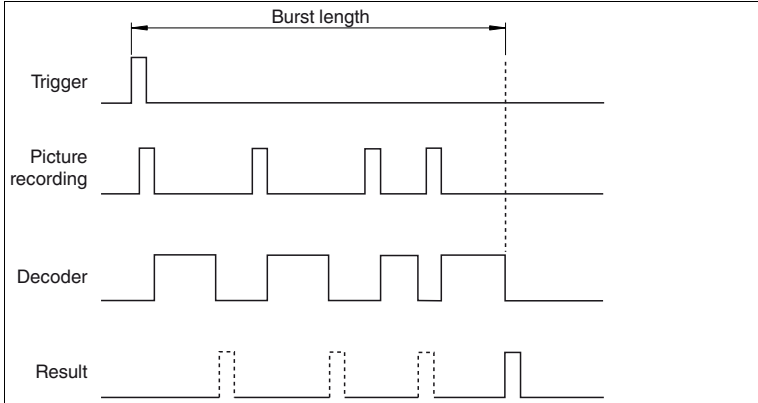

Figure 7.5 Pulse diagram burst trigger interval

Trigger Modes

Single trigger
 Interval burst trigger
 Frame burst trigger

Suppress No Read message (RS232, TCP/IP, Digital Output):

disable
 enable

Burst length: (1000ms ... 30001ms, 30001ms = ∞ ms)

Decoder limit: (10ms ... 10000ms)

Stop on Good Read (no stop at burst length ∞ ms)

Duplicate ignore duration: (0ms ... 30000ms)

Gain Hysteresis:

Step size:

Gain Hysteresis:

Step size:

-
-
- enabled, ±1 step
- enabled, ±2 steps
- enabled, ±3 steps
- enabled, ±4 steps
- enabled, ±5 steps
- enabled, ±6 steps
- enabled, ±7 steps
- enabled, ±8 steps
- enabled, ±9 steps
- enabled, ±10 steps
- enabled, ±11 steps
- enabled, ±12 steps
- enabled, ±13 steps
- enabled, ±14 steps
- enabled, ±15 steps

Trigger modes: Frame burst trigger

In Frame burst trigger mode, several images are captured and decoded for each external trigger. The maximum number of images and the time between each image captured in a burst is defined. Any other triggers that arise during the burst are ignored and counted as missed triggers. The frame burst trigger stops if decoding is successful.

- **Number of images per burst:** Specifies the maximum number of images captured in each burst. Option of selecting between 2 and 9.
- **Interval between frames:** Specifies the length of the intervals between the frames. Option of selecting between 20 ms and 30000 ms.
- **Decoder timeout:** Entry specifying the decoder timeout. Option of selecting between 10 ms and 10000 ms. Here, enter the maximum time that the decoder should attempt to decode a captured image.

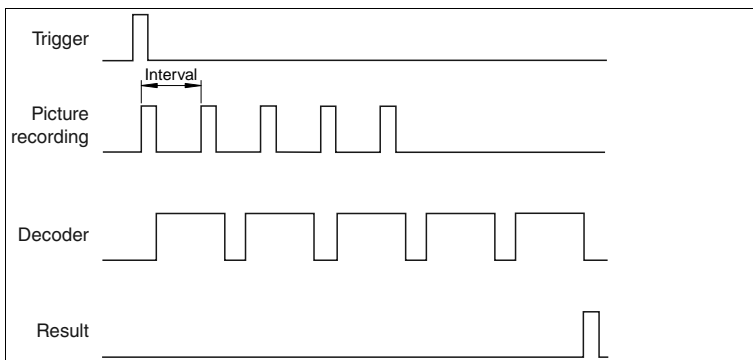
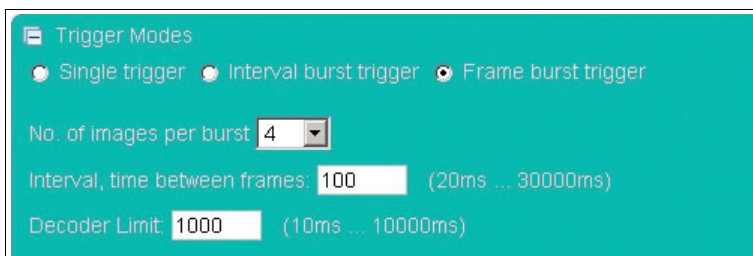

Figure 7.6 Pulse diagram burst trigger frame



Processing modes

Under Processing mode, you can specify whether an image should contain one or several symbols and whether these symbols should be imported. If several symbols are scheduled to be read, you will need to specify how the individual results will be used to compile the output string.

Processing mode: Single window

In Single window mode, you can search for and decode 1 symbol in 1 active window. The size and position of the window can be selected as required. Only the window area is processed to enable quicker decoding.

- **Reference code/match code:** The reference code/match code function can be used only in Single window processing mode.
- **Comparison code:** The comparison code is entered here. When the mouse is moved over the comparison code input window, the popup menu containing the nonprinting characters appears → see Figure 7.8 on page 29.
- **Read next code:** Press the OK button if you would like to accept the content of the next decoded symbol as reference content for the comparison code.
- **Good read output:** Specifies the character string that will be output if decoding was successful. This field uses Tooltip functionality. A table appears if the mouse pointer remains over one of the two input fields for more than 1 second. The table contains placeholders that can be inserted manually or by clicking the mouse. At present, the following information can be output as part of the output string: Code content, code length, status, decoding time, symbol coordinates, etc. A description of the placeholders can be found in the appendix see chapter 9.3.
- **Bad read output:** Specifies the character string that will be output if decoding was unsuccessful. A match code or timeout error will also result in the output of this string. A table appears if the mouse pointer remains over one of the two input fields for more than 1 second. The table contains placeholders that can be inserted manually or by clicking the mouse. At present, the following information can be output as part of the output string: Status, decoding time. A description of the placeholders can be found in the appendix see chapter 9.3.

Setting the detection range

The window areas selected in Single window and Multiwindow mode are visible only when the corresponding operating mode is activated.

1. The size and position of the individual windows can be adjusted only by using the mouse.
2. Move the cursor over the window you wish to modify.
3. Press the left mouse button while holding down the shift key to adjust the size. Move the mouse to change the size of the window.
4. Press the left mouse button to adjust the position. Move the mouse to change the position of the window.

↳ Repeat the process for all the windows you wish to modify.

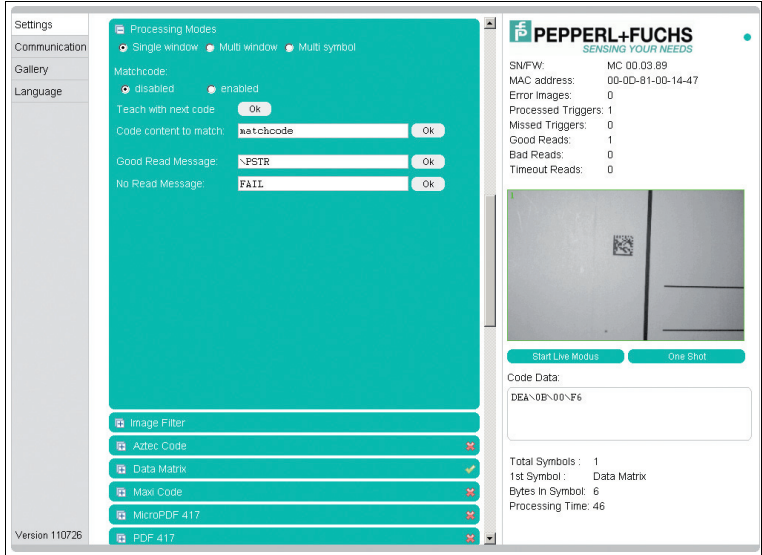

Figure 7.7 Menu item processing modes - single window

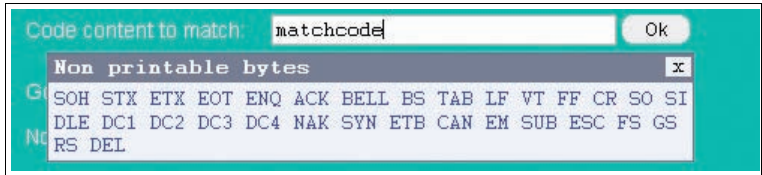

Figure 7.8 Tooltip matchcode

Processing mode: Multiwindow

In Multiwindow mode, you can search for and decode 1 symbol in a maximum of 4 different activated windows. The unread codes must be positioned completely inside the window to ensure that the individual area can be assigned reliably. The complete output string is compiled from the active read areas (linking) .

- **Window:** Activates or deactivates the individual areas scheduled for evaluation.
- **Good read output:** Specifies the character string that will be output if decoding was successful. This field uses Tooltip functionality. A table appears if the mouse pointer remains over one of the two input fields for more than 1 second → see Figure 7.10 on page 31. The table contains placeholders that can be inserted manually or by clicking the mouse. At present, the following information can be output as part of the output string: Code content, code length, status, decoding time, symbol coordinates, etc. A description of the placeholders can be found in the appendix see chapter 9.3.
- **Bad read output:** Specifies the character string that will be output if decoding was unsuccessful. A timeout error will also result in the output of this string. A table appears if the mouse pointer remains over one of the two input fields for more than 1 second → see Figure 7.10 on page 31. The table contains placeholders that can be inserted manually or by clicking the mouse. At present, the following information can be output as part of the output string: Status, decoding time. A description of the placeholders can be found in the appendix see chapter 9.3.

Setting the detection range

The window areas selected in Single window and Multiwindow mode are visible only when the corresponding operating mode is activated.

1. The size and position of the individual windows can be adjusted only by using the mouse.
2. Move the cursor over the window you wish to modify.
3. Press the left mouse button while holding down the shift key to adjust the size. Move the mouse to change the size of the window.
4. Press the left mouse button to adjust the position. Move the mouse to change the position of the window.

↳ Repeat the process for all the windows you wish to modify.

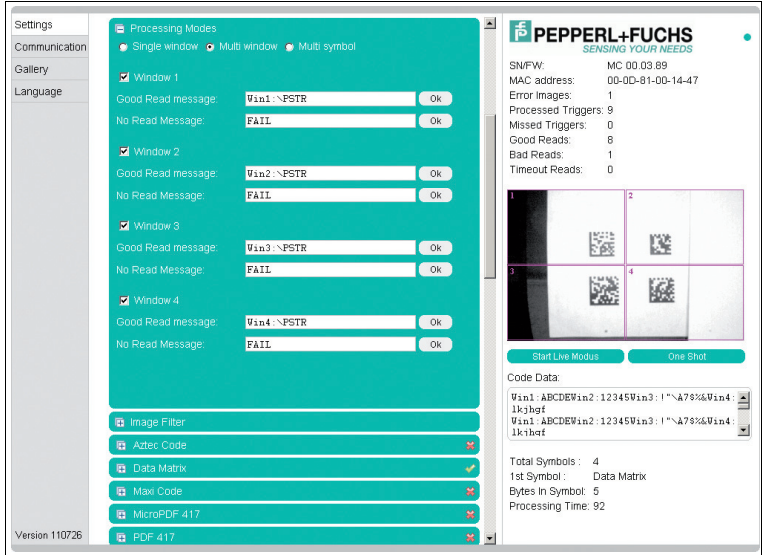

Figure 7.9 Menu item processing modes - multi window

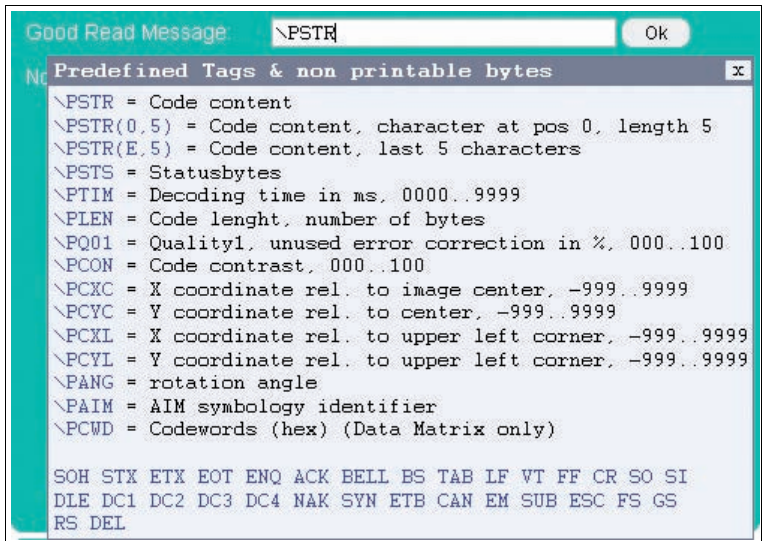

Figure 7.10 Tooltip good read message - bad read message

Processing mode: Multisymbology

Up to 4 different symbologies can be read in this mode. In contrast to Multiwindow mode, the entire image is always processed here. The position of the symbols within the image area is not important. The complete output string is compiled from the fixed sequence of preset symbologies (linking). The symbologies must be different and selected symbologies must also be activated globally in the respective sections so that a defined output string sequence can be allocated if the position of the image to be read is not defined. If the position of the read image is always the same, several identical symbologies can also be read simultaneously. Here, the sequence is from top to bottom and from left to right.

- **Symbology:** Specifies the symbology or symbology family.
- **Good read output:** Specifies the character string that will be output if decoding was successful. This field uses Tooltip functionality. A table appears if the mouse pointer remains over one of the two input fields for more than 1 second → see Figure 7.10 on page 31. The table contains placeholders that can be inserted manually or by clicking the mouse. At present, the following information can be output as part of the output string: Code content, code length, status, decoding time, symbol coordinates, etc. A description of the placeholders can be found in the appendix see chapter 9.3.
- **Bad read output:** Specifies the character string that will be output if decoding was unsuccessful. A timeout error will also result in the output of this string. A table appears if the mouse pointer remains over one of the two input fields for more than 1 second → see Figure 7.10 on page 31. The table contains placeholders that can be inserted manually or by clicking the mouse. At present, the following information can be output as part of the output string: Status, decoding time. A description of the placeholders can be found in the appendix see chapter 9.3.

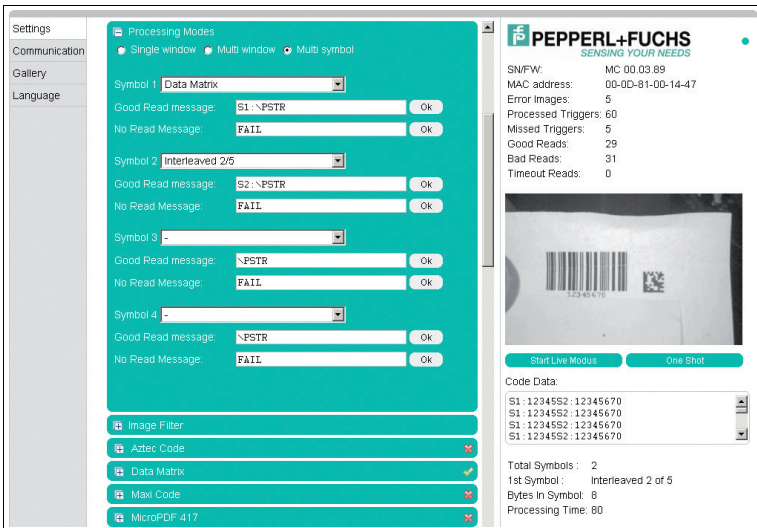

Figure 7.11 Menu item processing modes - multi symbol

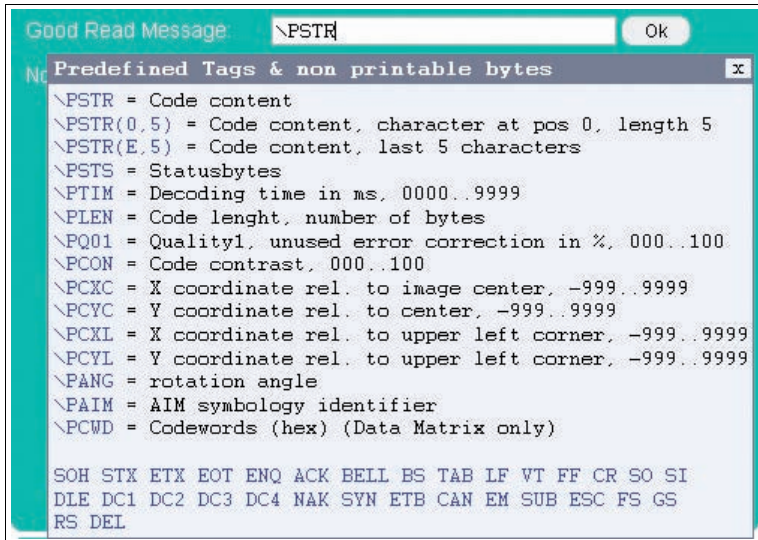
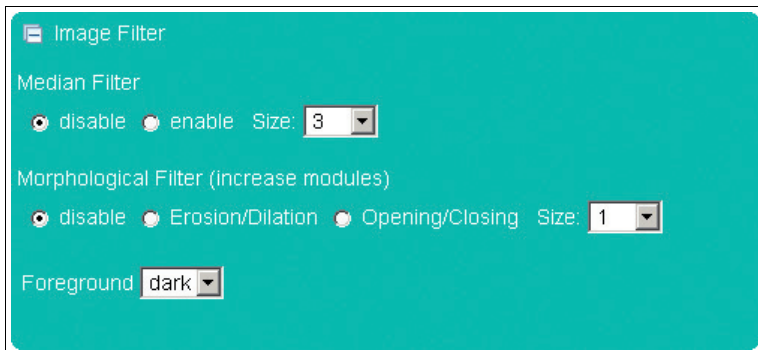

Figure 7.12 Tooltip good read message - bad read message

Prefilter

Definition of prefilters to make subsequent decoding easier.

- **Median filter:** Elimination of minor interference. The filter can be enabled or disabled with filter sizes 3, 5, 7, 9, 11.
- **Morphological filters (module enlargement):** Morphological filters are frequently used to suppress noise, segment images, etc. The filter can be disabled to Erosion/Dilatation or Opening/Closing. A filter size of 1 ... 6 can be selected.
- **Foreground (print color):** Specifies the print color. The values available are dark and light.



Aztec Code

The Aztec Code tab allows you either to deactivate the detection of these codes (**deactivated**), activate detection (**normal**), invert detection of the codes (all white fields are black and vice versa; **inverse**) or activate the detection of the codes irrespective of whether they are normal or inverted (**normal & inverse**).

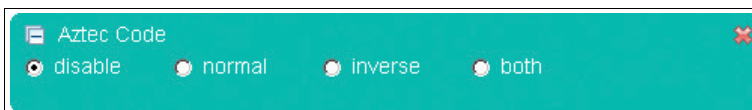

Data Matrix

The Data Matrix tab allows you to make the following settings:

- **Data Matrix:** You can either deactivate the detection of this code (**deactivated**) or activate the detection of this code, whereby the detection of normally printed codes (dark code, light code background), inversely printed codes (light code, dark code background) or both types (normal & inverse) can be activated simultaneously.
- **Rectangular Data Matrix activated:** You can activate the detection of rectangular Data Matrix codes.
- **Module size (µm):** Use this parameter to specify the minimum and maximum module size in µm.
- **Number of modules:** Use this parameter to specify the minimum and maximum number of modules.
- **Pixel / module:** Use this parameter to specify the number of pixels permitted per module.
- **Direction angle:** The orientation of the code can be set here. You have the choice of selecting **parallel to the axes** or **any**. Parallel to the axes **can** be selected when the sides of the code are positioned in parallel to the edges of the image. Any **must** be selected when the code is rotated to any position around its center point.
- **Permit non-square modules:** Permits the distortions that occur with some printing methods. (Rectangular distortion)
- **Permits print misalignment in multipart Data Matrix codes:** Permits print misalignment in "multi-tile" codes (> 32 x 32 modules).



Data Matrix ✓

disable
 normal
 inverse
 both

Decode rectangular data matrix

Module size (µm): min max

Module count: min max

Pixel / module

max 25
 max 50
 max 100

Code Alignment: Axis Omnidirectional

Allow non square modules
 Allow shifted tiles in multi-tile data matrix

Maxi Code

In the Maxi Code tab, you are able to define individual modes of the Maxi Code symbology.



Maxi Code ✗

Enable mode 0 decoding
 Enable mode 1 decoding
 Enable mode 2 decoding
 Enable mode 3 decoding
 Enable mode 4 decoding
 Enable mode 5 decoding
 Enable mode 6 decoding

MicroPDF 417

In the MicroPDF 417 tab, you can either activate or deactivate detection of the MicroPDF 417 code.



PDF 417

In the PDF 417 tab, you can either activate or deactivate detection of PDF 417 codes.



QR Code

In the QR Code tab, you can activate various modes.

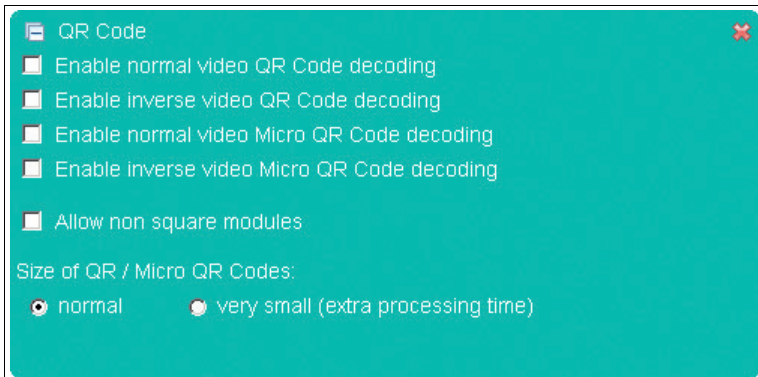

Codabar

In the Codabar tab, you can either activate or deactivate detection of the Codabar code. You can also activate or deactivate the checksum checker.

- **Checksum handling:** This feature enables you to activate or deactivate checking of the checksum using one of two options. One option is to compare the read code with the checksum and then to output the code with the checksum (check). The other option is to compare the code that has been read with the checksum and then to output the code without the checksum (check & remove).
- **Permit smaller quiet zone:** Codes with smaller quiet zones are also decoded.

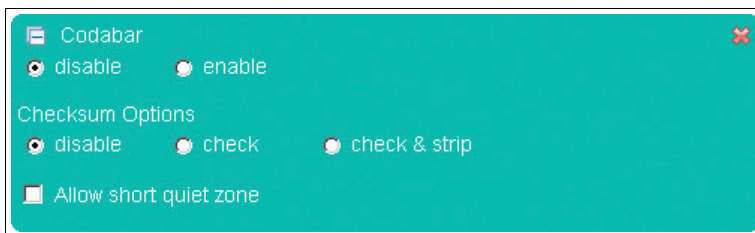

Codablock A

In the Codablock A tab, you can either activate or deactivate detection of the Codablock A code.



Codablock F

In the Codablock F tab, you can either activate or deactivate detection of the Codablock F code.



Code 11

In the Code 11 tab, you can either activate or deactivate detection of the Code 11 code.

- **Checksum handling:** This feature enables you to activate or deactivate checking of the checksum using one of two options. One option is to compare the read code with the checksum and then to output the code with the checksum (check). The other option is to compare the code that has been read with the checksum and then to output the code without the checksum (check & remove).

Example:

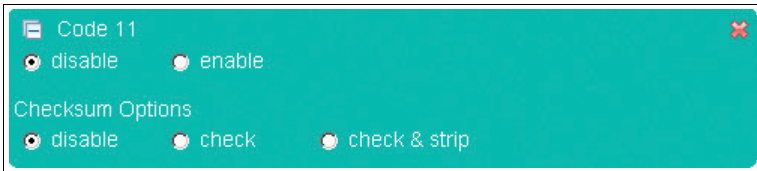

Code 39

In the Code 39 tab, you can either activate or deactivate detection of the Code 39 code.

- **Checksum handling:** This feature enables you to activate or deactivate checking of the checksum using one of two options. One option is to compare the read code with the checksum and then to output the code with the checksum (check). The other option is to compare the code that has been read with the checksum and then to output the code without the checksum (check & remove).
- **ASCII decoding activated:** Specifies whether ASCII decoding has been activated or not.
- **Permit smaller quiet zone:** Codes with smaller quiet zones are also decoded.

Example:

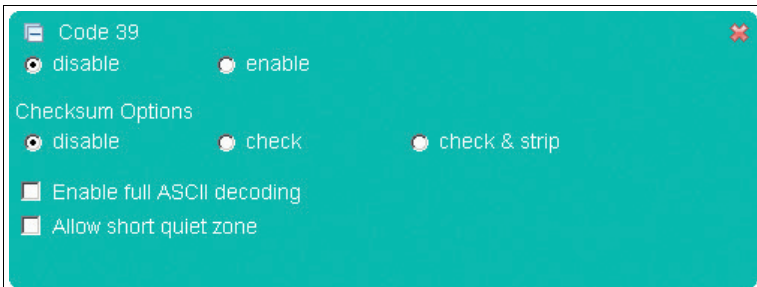

216677 2012-05

Code 93

In the Code 93 tab, you can either activate or deactivate detection of the Code 93 code.

- **Permit smaller quiet zone:** Codes with smaller quiet zones are also decoded.



Code 128

In the Code 128 tab, you can either activate or deactivate detection of the Code 128 code.

- **Permit smaller quiet zone:** Codes with smaller quiet zones are also decoded.



Composite Code

In the Composite Code tab, you can either activate or deactivate detection of the Composite code.



Hong Kong Code

In the Hong Kong Code tab, you can either activate or deactivate detection of the Hong Kong code.

- **Minimum code length:** Specifies the minimum size of the code that is to be detected.

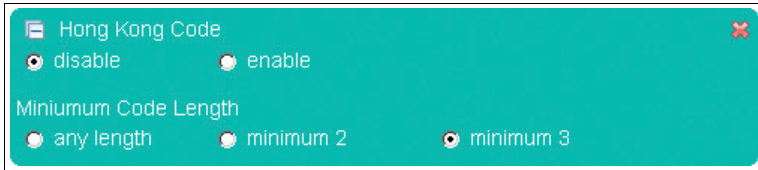

Interleaved 2 of 5

In the Interleaved 2 of 5 tab, you can either activate or deactivate detection of the Interleaved 2 of 5 code.

- **Checksum handling:** This feature enables you to activate or deactivate checking of the checksum using one of two options. One option is to compare the read code with the checksum and then to output the code with the checksum (check). The other option is to compare the code that has been read with the checksum and then to output the code without the checksum (check & remove).
- **Permit smaller quiet zone:** Codes with smaller quiet zones are also decoded.
- **Minimum code length:** Specifies the minimum size of the code that is to be detected.

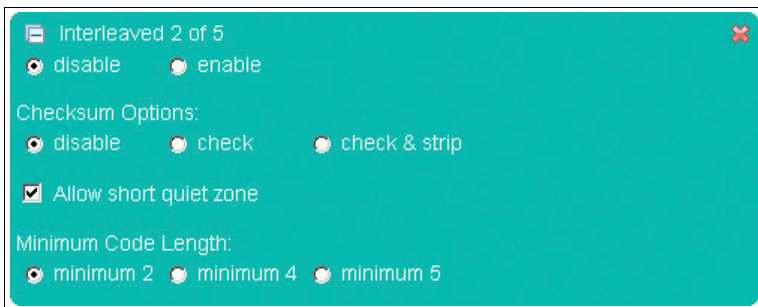

Matrix 2 of 5

In the Matrix 2 of 5 tab, you can either activate or deactivate detection of the Matrix 2 of 5 code.

- **Checksum handling:** This feature enables you to activate or deactivate checking of the checksum using one of two options. One option is to compare the read code with the checksum and then to output the code with the checksum (check). The other option is to compare the code that has been read with the checksum and then to output the code without the checksum (check & remove).
- **Minimum code length:** Specifies the minimum size of the code that is to be detected.

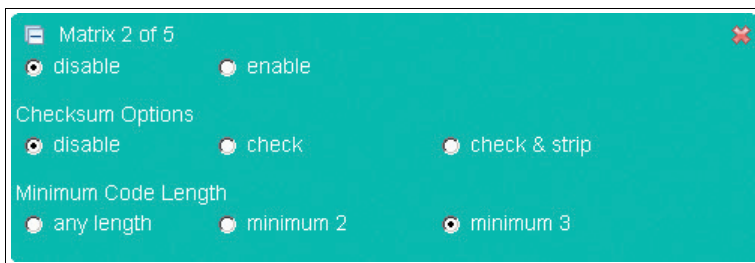

MSI Plessey

In the MSI Plessey tab, you can either activate or deactivate detection of the MSI Plessey code.

- **Checksum deactivated:** Allows you to deactivate the checksum

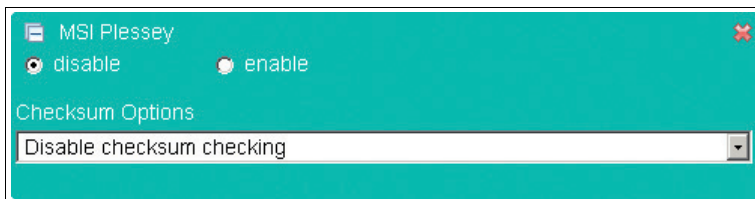

NEC 2 of 5

In the NEC 2 of 5 tab, you can either activate or deactivate detection of the NEC 2 of 5 code.

- **Checksum handling:** This feature enables you to activate or deactivate checking of the checksum using one of two options. One option is to compare the read code with the checksum and then to output the code with the checksum (check). The other option is to compare the code that has been read with the checksum and then to output the code without the checksum (check & remove).
- **Minimum code length:** Specifies the minimum size of the code that is to be detected.

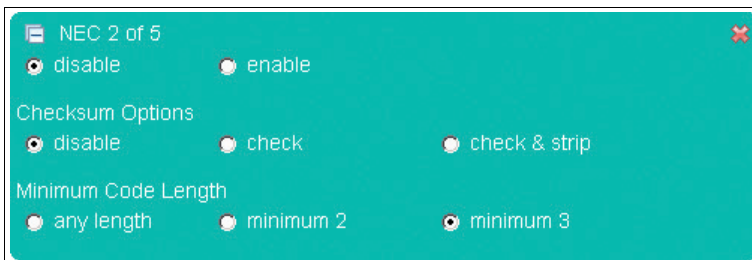

GS1 DataBar (RSS)

The RSS (Reduced Space Symbology) tab allows you to select the different detection options of the RSS code.

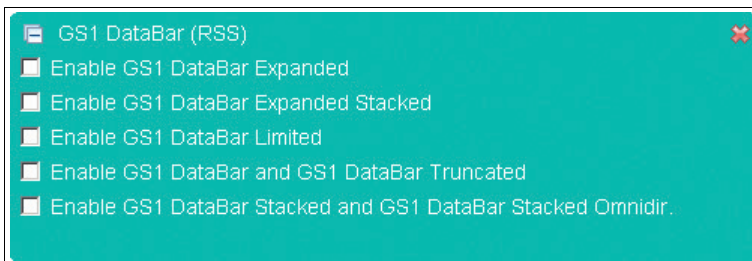

Industrial/Standard 2 of 5 (2 bar start/stop codes)

In the Straight 2 of 5 tab (2 bar start/stop codes), you can either activate or deactivate detection of the Straight 2 of 5 code (2 bar start/stop codes).

- **Minimum code length:** Specifies the minimum size of the code that is to be detected.

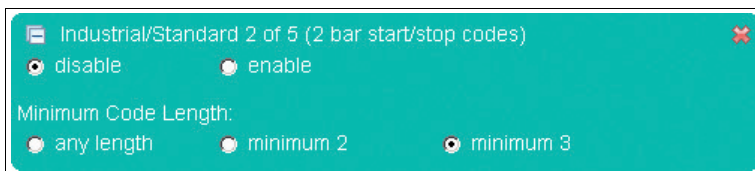

Industrial/Standard 2 of 5 (3 bar start/stop codes)

In the Straight 2 of 5 tab (3 bar start/stop codes), you can either activate or deactivate detection of the Straight 2 of 5 code (3 bar start/stop codes).

- **Minimum code length:** Specifies the minimum size of the code that is to be detected.

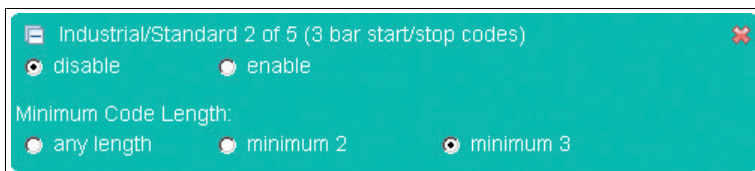

Telepen Code

In the Telepen tab, you can either activate or deactivate detection of the Telepen code.



Trioptic Code 39

In the Trioptic Code 39 tab, you can either activate or deactivate detection of the Trioptic Code 39 code.

- **Permit smaller quiet zone:** Codes with smaller quiet zones are also decoded.

Example:



UPC/EAN/JAN

In the UPC/EAN/JAN tab, you can either activate or deactivate detection of the UPC/EAN/JAN code.

- **Permit smaller quiet zone:** Codes with smaller quiet zones are also decoded.

Example:



Pharma Code

In the Pharma tab, you can either activate or deactivate detection of the Pharma code.

- **Number of bars:** Enter the minimum and maximum number of bars in the code.
- **Code contents:** Enter the number range that is to be decoded.
- **Direction angle:** Specify whether the code is to be read in a horizontal or a vertical direction.
- **Decoding direction:** Specify whether the code is to be read from left to right or from right to left.
- **Color bars:** If this setting is deactivated, only black color bars will be read cleanly.



Postal Code

In the Postal Code tab, you can either activate or deactivate detection of the Postal code.

- **Direction angle:** Enter the direction angle of the code here. Omnidirectional is the standard setting, although this means that it will take longer to read the code.
- **Australia Post Code with zero FCC & DPID activated:** Activate or deactivate the Australia Post Code with zero FCC & DPID.
- **Number of lines:** Enter the minimum and maximum number of lines in the code.
- **Output of non-decodable symbols in the field (mm):** Enter the field in which non-decodable symbols are located that need to be detected.

Example: 

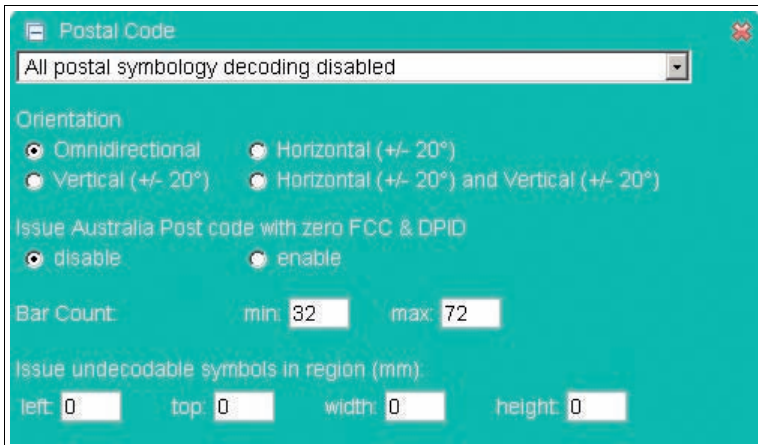

OCR

- **OCR:** Specifies whether OCR font recognition is deactivated (**deactivated**) or activated, whereby the detection of normally printed font (dark font, light background), inversely printed fonts (light font, dark font background) or both types (normal & inverse) can be activated simultaneously.
- **Text flow direction:** Specifies the direction in which the OCR code should be read. For example, it is necessary to indicate whether the character string HOHOHO on a OCR code should be read from right to left or from left to right.
- **Individual line:** Specifies whether an individual line for placing a template is output if there are other characters immediately above or below it.
- **Remove checksum:** You have the option of removing a read checksum before the decoded OCR code is output. The output code no longer contains the checksum as a result.
- **Inhomogeneous background:** You can select this field to enhance OCR recognition. This field is recommended if you have selected the pass template. Many countries print a pattern behind the OCR code on the ID, which prevents the code from being read properly. However, the processing time increases when the field is selected.
- **Output ambiguous characters:** This function only influences OCR output when the pass template is selected.
- **Disable '.' characters:** Suppresses the detection/output of '.' characters (e.g., decimal point, end of sentence). '.' characters that form part of a user template are ignored.
- **Ignore pass checksums:** You also have the option of reading identity cards, visas, and passports that do not meet ICAO checksum standards. If the function is deactivated and the ID does not meet ICAO standards, no results are generated.
- **Templates:** You have the option of choosing from a selection of existing templates.
- **User template:** Selecting the "User-defined" field under "Templates" allows you to compile your own template. A table is displayed if the mouse pointer remains over one of the two input fields for more than 1 second. The table contains placeholders that can be inserted manually or by clicking the mouse.

OCR ✖

disable
 normal
 inverse
 both

Flow of Text (hint for rotationally ambiguous text):

↑ up
 ↓ down
 ← right to left
 → left to right
 none

Single Row:

disable
 enable

Strip checksum:

disable
 enable

Busy background (extra processing):

disable
 enable

Issue uncertain (passport template only):

disable
 enable

Disable . character:

no
 yes

Ignore passport checksums:

disable
 enable

Templates:

Passport
 ISBN
 Price Field
 MICR E-13B
 User defined

User Template:

User Template:

OCR template elements ✖

```

00 = End of Template
0101 = New Template, Font: OCR-A
0102 = New Template, Font: OCR-B
0103 = New Template, Font: OCR-A & OCR-B
0104 = New Template, Font: MICR E-13B
0105 = New Template, Font: SEMI OCR
02 = New Line
03ID = Define Group Start, (ID=00-FF)
04 = Define Group End
05 = Wildcard: Numeric (0-9)
06 = Wildcard: Alpha (A-Z)
07 = Wildcard: Alphanumeric (0-9,A-Z)
08 = Wildcard: Any (incl. Space)
0AID = Define Group (ID=00-FF)
0B = In Line Group Start
0C = In Line Group End
0ECT = Fixed character repeat (CT=00-32)
0FRLRH = Variable character repeat, (RL=00-32, RH=00-32)
A B C D E F G H I J K L M N O P Q R S T U V W X Y Z
0 1 2 3 4 5 6 7 8 9
# $ % & ( ) * + - . / < > @ # euro £ ¥ SPACE
    
```

The following font types are supported:

OCR-A

ABCDEFGHIJKLMNOPQRSTUVWXYZ
0123456789
\$ & () * + - . / < > @ \ € £ ¥

OCR-B

ABCDEFGHIJKLMNOPQRSTUVWXYZ
0123456789
\$ & () * + - . / < > @ \ € £ ¥

MICR E-13B

0 1 2 3 4 5 6 7 8 9 : ; , ' " # \$ % & ' () * + - . / < > @ \ € £ ¥

SEMI OCR

ABCDEFGHIJKLMNO
PQRSTUVWXYZ-
0123456789.

7.1.2

Communication Tab

The **Communication** tab allows you to configure various network and transmission parameters. In the left display area, you can navigate to the other tabs **Settings**, **Gallery** and **Language**.

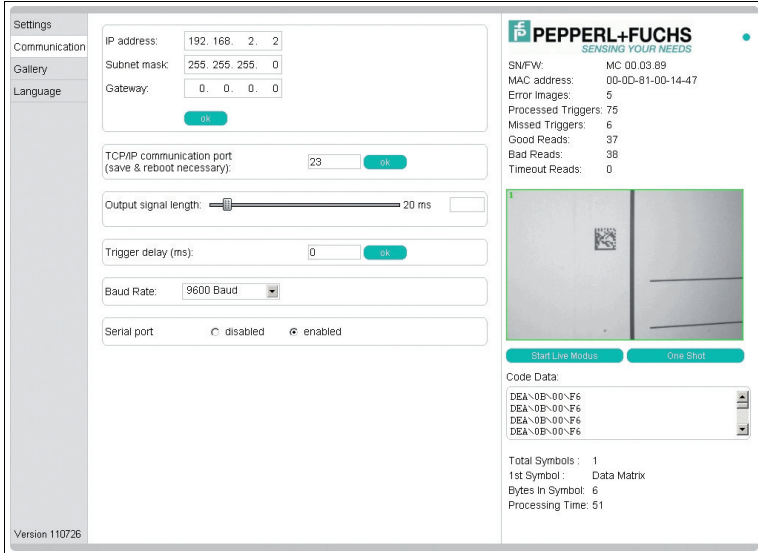

In the center of the screen, the following functions are available in different fields:

Parameters	Explanation
IP address	Assign a new IP address to the sensor using this field.
Subnet mask	Change the subnet mask using this field.
Gateway	Change the gateway using this field.
TCP/IP port for process communication	Change the TCP/IP port using this field. The output strings are sent to the remote station (e.g., PLC) via this port. After making the changes, you must press OK to confirm your entries and reboot the system.
Output signal length	Change the temporal length of the output signal using this field.
Trigger delay [ms]	Change the trigger delay using this field. Value range: 1 ms ... 255 ms
Baud rate	Change the baud rate using this field.
Serial port	Activate or deactivate the RS232 interface output.



Transferring parameters

1. Carry out the desired settings.
2. Transfer the settings by clicking **OK** .

7.1.3 Tab Gallery

The **Gallery** allows you to view the saved error images and save them locally on the PC if necessary. You can navigate to the other tabs **Settings**, **Communication** and **Language** in the left display area.

In the upper section of the display, the last 6 error images saved in the stationary reader are shown as a preview.

You can save the images locally in pgm or gif format.

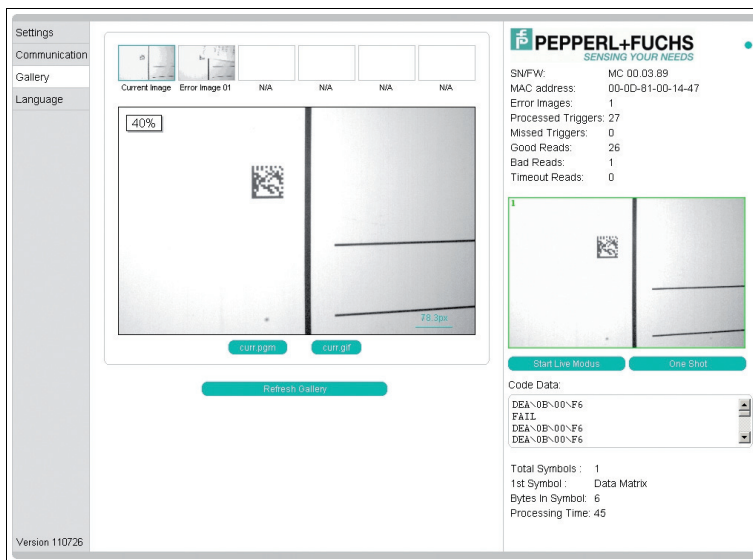

Saving an image locally



Note!

In the following instructions, the asterisk [*] stands for the file name of the image, since the button name varies depending on the preview image selected.

1. Click the ***.pgm** or ***.gif** button below the image display.
2. Select the memory location, change the file name if necessary, and click **Save**.

7.1.4 Dialog box **Language**

The **Language** enables you to change the language for the entire operator interface. You can navigate to the other tabs **Settings**, **Communication** and **Gallery** in the left display area.

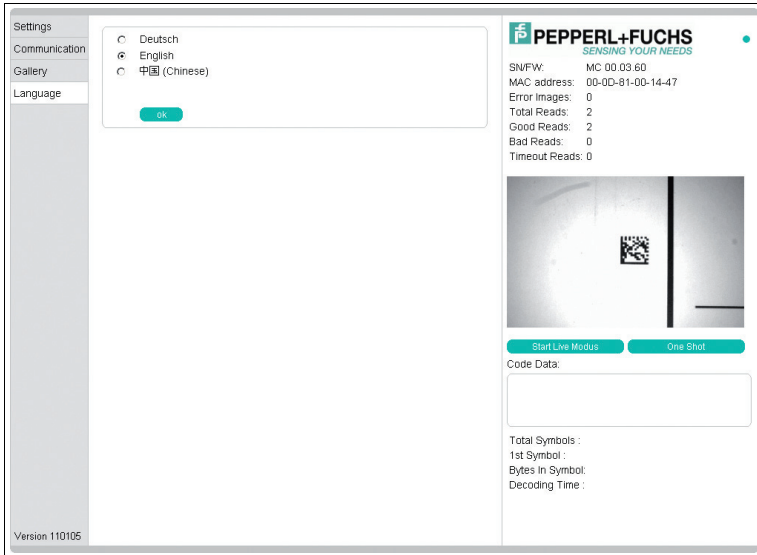

Selecting/changing the language

1. Choose one of the options **German**, **English** and **Chinese**.
2. To implement the selection, click **OK**.

↳ The selected language will be adopted.

8 Troubleshooting

8.1 What to do in the event of an error

Before requesting a service call, please check that the following actions have been taken.

- Test the equipment according to the following checklists,
- Telephone assistance from the Service Center in order to isolate the problem.

Check list

Error	Cause	Remedy
"ST" LED not lit up	The power supply is switched off.	Check whether there is a reason for it being switched off (installation or maintenance work etc.). Switch the power supply on if appropriate.
"ST" LED not lit up	The Sub-D socket is not connected to the connector on the sensor.	Connect the Sub-D socket to the sensor and tighten the screws by hand.
"ST" LED not lit up	Wiring fault in the distributor or control cabinet.	Check the wiring carefully and repair any wiring faults.
"ST" LED not lit up	Supply line to the sensor is damaged.	Replace the damaged wire.
No connection to the device	Network cable not connected.	Connect the network cable.
No connection to the device	Wrong network cable used.	Direct connection between PC and device: Use a crossover network cable. Connection via an existing network: Use a twisted-pair network cable.

- If none of the above remedies have had the desired effect, please contact the Service Center. Please have the fault patterns and version number of the ODT-MAC4** system at hand. The version number can be found at the bottom left of the operator interface.

9 Appendix

9.1 Command format

Commands

Each command consists of 4 ASCII-coded hexadecimal digits (CD₂D₁D₀) without <CR> or <LF> .

Meaning of the individual digits

Syntax:	<C> <D ₂₁₀	
Meaning	C	Command
	D ₂	Detail 2
	D ₁	Detail 1
	D ₀	Detail 0
Example	Command: Read (8) Detail none (000)	Complete command: 8000

Each sent hexadecimal character is echoed by the device. A <LF><CR> is sent after the 4 valid characters are received. Other characters are interpreted as the next command.

V1 prompt

A command code such as 0123 would cause the following echo:

C:0123<LF><CR>.

V1 command termination

Press the“ESC”button to terminate a command at any point in the 4 ASCII character string. In this case, the device does not wait for the next character. If ESC is pressed for the first character, the device responds with

C:<ESC><LF><CR>.

Timeout

A V1 command character must be input within one second. If no characters are input within this time, <LF><CR> is sent and the device waits for the first character again.

V1 data information

All D commands trigger an output. Characters 2 and 3 of the sent command are always echoed at the start of this operation.



Caution!

Characters 2 and 3 are always echoed as uppercase letters, regardless of whether they were lowercase or uppercase beforehand.

Example: Input:D100 => Output:D100<LF><CR>10Decoder
Ver. 4.01.0T<LF><CR>.

Status message

The status message is generated automatically when decoding is triggered and the decoding process is complete.

Status message

Syntax	<Command> <fOk> <Error code> <ECC> <Data> <cr> <lf>	
Meaning	Command (1 hex digits)	The first digit of the command is output
	fOk (1 decimal digit)	0: Ok, 1: Error
	Data (unlimited number)	Data contained in larger/smaller (>/<) characters, if data output is active
	LF	ASCII end character: 0A
	CR	ASCII end character: 0D
Example	Good reading	MAC34x only: 800001>DataFromDataMatrix< MAX4xx/MAC5xx: 80>DataFromDataMatrix<
	Bad reading	MAC34x only: 81FF00 MAX4xx/MAC5xx: 81FAIL

9.2 Command overview

This table contains a list of all the commands which you can send individually to the stationary reader from the Settings tab page.

Alternatively, these commands but also about the process interface are (RS232 / TCP / IP) is sent.

The following notation is used.

H: Here you can enter setting values as hexadecimal numbers.

X: Here you can enter any hexadecimal numbers. These values are ignored for the settings.

Commands 0 to 8

Command				Description
C	D ₂	D ₁	D ₀	
0	H	H	X	Flash duration in intervals of 10 µs. Example: 0120 _H sets the flash duration to 180 µs
2	H	H	X	Sets the pulse length of the outputs (D ₂ D ₁)
5	H	H	X	Video gain, default=50 _H (decimal:80)
				For continuous reading, the burst length must be set to 30001
8	0	0	0	Trigger resolution for single reading Trigger start with interval burst trigger
8	4	0	0	Trigger stop with interval burst trigger

Command A

Command				Description
C	D ₂	D ₁	D ₀	
A	H	H	X	Set shutter time D ₂ D ₁ . Shutter time in 30 µs increments (default=00, shutter time follows flash duration)

Command C

Command				Description																																	
C	D ₂	D ₁	D ₀																																		
C				Advanced commands Parameter D ₂ indicates the advanced command																																	
	5	H	H	Sets the filter parameters to be used when specifying the filter type using C6xx. The possible parameter values are, therefore, entered using the command C6xx. Important: This command must be issued before the command C6xx! The entered values become invalid when the C6xx command is issued (can only be used once!)																																	
	6	0	H	Filter selection for preprocessing and debug Important: Enter the filter parameters first using the command C5xx!!																																	
				<table border="1"> <thead> <tr> <th>Value</th> <th>Set</th> <th>Function</th> </tr> </thead> <tbody> <tr> <td>0x00</td> <td></td> <td>All filters are disabled</td> </tr> <tr> <td>0x01</td> <td></td> <td> Extend areas (erosion/dilatation) Possible parameter values using C5xx: </td> </tr> <tr> <td></td> <td>0x00</td> <td>Filter off</td> </tr> <tr> <td></td> <td>0xXY</td> <td> Filter size in X and Y direction, possible values in each case: 0x1 to 0x6: extend light areas. 0x9 to 0xE: extend dark areas (0x1 to 0xE plus offset 0x8) (for both dimensions 1 ... 6 or 9 ... E, but areas not mixed) </td> </tr> <tr> <td>0x02</td> <td></td> <td> Open or close areas (opening/closing) </td> </tr> <tr> <td></td> <td>0x01</td> <td>Filter off</td> </tr> <tr> <td></td> <td>0x02</td> <td> Filter size in X and Y direction, possible values 1 to 6 in each case: 0x1 to 0x6: extend light areas. 0x9 to 0xE: extend dark areas (0x1 to 0xE plus offset 0x8) (for both dimensions 1 ... 6 or 9 ... E, but areas not mixed) </td> </tr> <tr> <td>0x03</td> <td></td> <td> Use median filter (homogenization in the case of grainy codes/images) Possible parameter values using C5xx: </td> </tr> <tr> <td></td> <td>0x01</td> <td>Filter off</td> </tr> <tr> <td></td> <td>0x0X</td> <td>Quadratic filter size 3, 5, 7, 9, and 11 (0x0B)</td> </tr> </tbody> </table>	Value	Set	Function	0x00		All filters are disabled	0x01		Extend areas (erosion/dilatation) Possible parameter values using C5xx:		0x00	Filter off		0xXY	Filter size in X and Y direction, possible values in each case: 0x1 to 0x6: extend light areas. 0x9 to 0xE: extend dark areas (0x1 to 0xE plus offset 0x8) (for both dimensions 1 ... 6 or 9 ... E, but areas not mixed)	0x02		Open or close areas (opening/closing)		0x01	Filter off		0x02	Filter size in X and Y direction, possible values 1 to 6 in each case: 0x1 to 0x6: extend light areas. 0x9 to 0xE: extend dark areas (0x1 to 0xE plus offset 0x8) (for both dimensions 1 ... 6 or 9 ... E, but areas not mixed)	0x03		Use median filter (homogenization in the case of grainy codes/images) Possible parameter values using C5xx:		0x01	Filter off		0x0X	Quadratic filter size 3, 5, 7, 9, and 11 (0x0B)
	Value	Set	Function																																		
	0x00		All filters are disabled																																		
	0x01		Extend areas (erosion/dilatation) Possible parameter values using C5xx:																																		
		0x00	Filter off																																		
		0xXY	Filter size in X and Y direction, possible values in each case: 0x1 to 0x6: extend light areas. 0x9 to 0xE: extend dark areas (0x1 to 0xE plus offset 0x8) (for both dimensions 1 ... 6 or 9 ... E, but areas not mixed)																																		
	0x02		Open or close areas (opening/closing)																																		
		0x01	Filter off																																		
		0x02	Filter size in X and Y direction, possible values 1 to 6 in each case: 0x1 to 0x6: extend light areas. 0x9 to 0xE: extend dark areas (0x1 to 0xE plus offset 0x8) (for both dimensions 1 ... 6 or 9 ... E, but areas not mixed)																																		
	0x03		Use median filter (homogenization in the case of grainy codes/images) Possible parameter values using C5xx:																																		
		0x01	Filter off																																		
		0x0X	Quadratic filter size 3, 5, 7, 9, and 11 (0x0B)																																		
	4	0	0	Set V1 standard interface (default, no other interface currently available)																																	
	7	H	H	Change baud rate																																	
			<table border="1"> <thead> <tr> <th>Wert</th> <th>Baud rate</th> </tr> </thead> <tbody> <tr> <td>0x00</td> <td>9600 baud</td> </tr> <tr> <td>0x01</td> <td>19200 baud</td> </tr> <tr> <td>0x02</td> <td>38400 baud</td> </tr> <tr> <td>0x03</td> <td>57600 baud</td> </tr> <tr> <td>0x04</td> <td>76800 baud</td> </tr> <tr> <td>0x05</td> <td>115200 baud</td> </tr> <tr> <td>0x06</td> <td>4800 baud</td> </tr> <tr> <td>0x07</td> <td>2400 baud</td> </tr> </tbody> </table>	Wert	Baud rate	0x00	9600 baud	0x01	19200 baud	0x02	38400 baud	0x03	57600 baud	0x04	76800 baud	0x05	115200 baud	0x06	4800 baud	0x07	2400 baud																
Wert	Baud rate																																				
0x00	9600 baud																																				
0x01	19200 baud																																				
0x02	38400 baud																																				
0x03	57600 baud																																				
0x04	76800 baud																																				
0x05	115200 baud																																				
0x06	4800 baud																																				
0x07	2400 baud																																				

Command				Description	
C	D ₂	D ₁	D ₀		
C	A	X	0	Loading parameters from the flash memory. A differentiation is not made between the default and the working area.	
	A	X	1	Restoring default settings	
	A	X	2	Reset IP / subnet / gateway to 192.168.2.2 / 255.255.255.0 / 0.0.0.0	
	B	0	0	Saving parameters in flash.	
	E	H	H	Error image processing Error images are only saved if the system has sufficient resources. Decoding and image capture have top priority.	
				Value	Output
				00	Provides the number of saved error images
				01 - 05	CE01 to CE05 display error images 1 to 5
				09	Displays the last captured image
				10	Displays the last captured image
	F	00		Reserved	
	F	H		Sets resolution	
				Value	Resolution
				1	VGA 640x480
				5	WVGA 752x480
	F	X	H	Sets partial capture. Always begins at line 0	
				Value	Image height as a proportion of the overall image height, beginning at line 0
				0	1/1 (standard)
				1	1/2 (half image captured)
				2	1/3 (only the first third of the image is evaluated)
			3	1/3 (only the first third of the image is evaluated)	
			4	1/3 (only the first third of the image is evaluated)	
			5	3/4 (only three quarters of the image is evaluated)	

Command D (only works via the serial interface)

Command				Description
C	D ₂	D ₁	D ₀	
D				Send information Parameter D ₂ specifies the type of information. First, D ₂ is repeated in the output, followed by the values. The string is tested for 10D OR 10M with autodetect and it must not be longer than 20 characters.
	1	0	0	Decoding software version (ends with <CR><LF>)
	3	X	X	Video gain
	6	X	X	Additional information
	6	1	X	Flash duration
	6	3	X	Timeout, reading

Additional commands for stationary readers with laser pointer

Command				Description	
C	D ₂	D ₁	D ₀		
E	F	0	H	Control laser pointer	
				Value	Effect
				0	All laser pointer off
				1	Laser pointer 1 off, laser pointer 2 on
				2	Laser pointer 1 on, laser pointer 2 off
				3	All laser pointer on

9.3 Input of nonprintable characters

The following syntax is used to display nonprintable characters. A \ character is appended to the ASCII value of the character as a 2-digit hex number.

Example: A Carriage Return (CR) character is coded ASCII 013 (decimal) or 0D (hex). \0D is entered in the web interface.

In principle, every character can be set in this way. For reasons of legibility, however, we recommend that printable characters be entered directly.

Limitations

The null byte (ASCII 0) cannot be used. (Permissible range: \01 ... \FF)

The \ character itself must be entered as \24

You can also enter whole character strings.

Examples of character strings

\02ABCDEFGH STX byte, followed by the letters A to H

\02[STX byte, followed by a [character

\A0\B0777\03 ASCII A0 (hex), ASCII B0 (hex), 777 and an ETX byte

You can enter the space character from the keyboard in the normal way. For reasons of legibility, however, it is displayed as \20 once entered.

Selected nonprintable characters and their meaning

Decimal	Hexa-decimal	Web Interface	Meaning, alternative designation
000	00	N/A	The null byte cannot be displayed so please do not use it!
001	01	\01	SOH - start of heading
002	02	\02	STX - start of text
003	03	\03	ETX - end of text
004	04	\04	EOT - end of transmission
005	05	\05	ENQ - enquiry
006	06	\06	ACK - acknowledge
007	07	\07	BELL - bell
008	08	\08	BS - backspace
009	09	\09	TAB - tabulator
010	0A	\0A	LF - linefeed
011	0B	\0B	VT - vertical tab
012	0C	\0C	FF - formfeed page
013	0D	\0D	CR - carriage return
014	0E	\0E	SO - shift out
015	0F	\0F	SI - shift in

Decimal	Hexa-decimal	Web Interface	Meaning, alternative designation
016	10	\10	DLE - data link escape
017	11	\11	DC1
018	12	\12	DC2
019	13	\13	DC3
020	14	\14	DC4
021	15	\15	NAK - negative acknowledge
022	16	\16	SYN - synchronous idle
023	17	\17	ETB - end of transmission block
024	18	\18	CAN - cancel
025	19	\19	EM - end of medium
026	1A	\1A	SUB - substitute
027	1B	\1B	ESC - escape
028	1C	\1C	FS - field separator
029	1D	\1D	GS - group separator
030	1E	\1E	RS - record separator
031	1F	\1F	DEL
032	20	\20	SPC - Space

Table 9.1 Nonprintable characters

It is also possible to enter the following placeholders in the **Good Read Message and No Read Message** field so that predefined information can be output.

Placeholders and their meaning

Placeholder	Meaning
\PSTR	Decoded code content
\PSTR (x,y)	From character x (counting starts at 0), with length y, length positive. Example: \PSTR (0,5) -> the first 5 characters of the code are output.
\PSTR (E,x)	x characters from the end until the end Example: \PSTR (E,3) -> the last 3 characters of the decoded string are output.
\PLEN	Length of the code in characters/bytes, 4-digit numerical value, decimal, range: 0000 ... 9999
\PQ01	Quality value 1, unused error correction with certain symbologies, 3-digit numerical value, decimal, range: 000 ... 100. If no symbol was decoded, 000 will be output.
\PANG	Angle between the lower symbol edge and horizontal (long) image edge
\PCON	Contrast value across the range of the decoded code, 3-digit numerical value, decimal, range: 000 ... 100. Low values indicate a low level of contrast. If no symbol was decoded, 000 will be output.
\PCWD	Code words from the code (Data Matrix only)
\PTIM	Actual cycle time. Time required to capture and decode an image. 4-digit numerical value, decimal, range: 0000 ... 9999. Also valid in the event of Timeout and No Read.

216677 2012-05

Placeholder	Meaning
\PSTS	Status bytes. Two-digit numerical value, decimal 80 - Good reading 81 - Bad reading 82 - Good reading of match code, match OK 83 - Good reading of match code, match NOT OK 84 - Bad reading because timeout reached
\PCXC	X coordinate of the center point of the code relative to the center point of the image, 4-digit numerical value, decimal, range: -999 ... 0000 ... 9999, unit: pixel
\PCYC	Y coordinate of the center point of the code relative to the center point of the image, 4-digit numerical value, decimal, range: -999 ... 0000 ... 9999, unit: pixel
\PCXL	X coordinate of the center point of the code relative to the top left corner of the image, 4-digit numerical value, decimal, range: 0000 ... 9999, unit: pixel
\PCYL	Y coordinate of the center point of the code relative to the top left corner of the image, 4-digit numerical value, decimal, range: 0000 ... 9999, unit: pixel

Table 9.2 Placeholder for Good Read and No Read message

Examples of Good Read message

\PSTR\0D\0A Code content, Carriage Return, New Line

\02>\PSTR<\03\0D
\0A STX, > character, code content, < character, ETX, Carriage Return, New Line

#\PSTS_\PQ01_\P
CON # character, status byte, _ character, quality 1, _ character, contrast

\PSTR(0,3)\PSTR(
E,2) The first 3 characters and the last 2 characters of the code content

Examples of No Read message

NO_READ\0D\0A "NO_READ" String, Carriage Return, New Line

\02>FAIL<\03\0D\0
A STX, > character, "Fail" string, < character, ETX, Carriage Return, New Line

#\PSTS_\PTIM # character, status bytes, _ character, cycle time

FACTORY AUTOMATION – SENSING YOUR NEEDS



Worldwide Headquarters

Pepperl+Fuchs GmbH
68307 Mannheim · Germany
Tel. +49 621 776-0
E-mail: info@de.pepperl-fuchs.com

USA Headquarters

Pepperl+Fuchs Inc.
Twinsburg, Ohio 44087 · USA
Tel. +1 330 4253555
E-mail: sales@us.pepperl-fuchs.com

Asia Pacific Headquarters

Pepperl+Fuchs Pte Ltd.
Company Registration No. 199003130E
Singapore 139942
Tel. +65 67799091
E-mail: sales@sg.pepperl-fuchs.com

www.pepperl-fuchs.com

 **PEPPERL+FUCHS**
SENSING YOUR NEEDS