



Operating instructions

KT-LED-96-2R-230VAC KT-LED-96-2R-24VDC

Process Controller

for thermocouples

measuring resistors

resistance thermometers

sensors in mV range

with 2 alarms



1	Safety instructions and warnings	4
1.1	Use according to the intended purpose	4
2.	Technical Data	
2.1	Miscellaneous Data	5
2.2	Electrical Data	5
2.2.1	Power Supply	5
2.2.2	Inputs	5
2.2.3	Outputs	
2.3	Mechanical Data	7
2.4	Environmental conditions	7
2.5	Delivery	7
2.6	Order Code	7
3.	Mounting	8
4	Electrical Connections	9
4.1	Measuring input	9
4.2	Control Inputs and Auxiliary Signals	10
4.3	Power Supply and Outputs	10
5	Parameter Setup	11
5.1	Parameter mode	11
5.2	Parameter input for actual measured value	12
5.3	Select range for the input signal	12
5.3.1	Thermocouples	12
5.3.1.1	Select type of thermocouples	12
5.3.1.2	Select display unit	12
5.3.1.3	Cold junction compensation	12
5.3.1.4	Set external cold junction compensation	14
5.3.1.5	Correction value	14
5.3.2	Resistance Measurement	14
5.3.2.1	Select measuring mode	14
5.3.2.2	Measurement range	15
5.3.2.3	Display unit (Pt100/Pt1000)	15
5.3.2.4	Correction value (Pt100/Pt1000)	15
5.3.2.5	Decimal point (400Ω/4000Ω)	16
5.3.2.6	Changing the scaling slope (400Ω/4000Ω)	16
5.3.3	Input range 0 ... 100 mV DC	16
5.3.3.1	Decimal point for displayed value	16
5.3.3.2	Changing the scaling scope	16
5.3.4	Input range -100 ... +100 mV DC	17
5.3.4.1	Select decimal point	17
5.3.4.2	Changing the range limits	17
5.3.4.3	Changing the scaling scope	18

5.4	Setting the scaling slope	14
5.4.1	Enter the number of scaling points	20
5.4.2	Define the first scaling point	20
5.4.3	Define the second scaling point	20
5.4.4	Define additional scaling point	20
5.5	Alarms/Alarm Outputs	
5.5.1	Alarm 1/Output 1	21
5.5.1.1	Alarm 1 off/on	21
5.5.1.2	Select mode for output threshold 1	21
5.5.1.3	Hysteresis for threshold 1	22
5.5.1.4	Reset Latch signal at output 1	23
5.5.1.5	Select signal form for output threshold 1	23
5.5.2	Alarms 2/Output 2	24
5.5.2.1	Alarm 2 off/on	24
5.5.2.2	Select mode for output threshold 2	24
5.5.2.3	Hysteresis for output 2	24
5.5.2.4	Reset Latch signal at output 2	25
5.5.2.5	Select signal form for output threshold 2	25
5.6	MIN/MAX value acquisition	25
5.6.1	Monitor maximum value	25
5.6.1.1	Reset maximum value	26
5.6.2	Monitor minimum value	26
5.6.2.1	Reset minimum value	26
5.7	Mains Hum Filter	26
5.8	Setting Default Values.....	28
5.9	End of setup.....	28
5.10	Check / alter parameters	28
6	Operation	24
6.1	Switching over the display during operation	29
6.2	Setting the limits during operation	30
6.3	Resetting the MIN/MAX value	31
6.4	Display Hold	32

1 Safety instructions and warnings



Only use this display
– in a way according to its intended purpose
– if its technical condition is perfect
– adhering to the operating instructions and the general safety instructions.

1. Before carrying out any installation or maintenance work, make sure that the power supply of the digital display is switched off.
2. Only use this digital display in a way according to its intended purpose.
3. If its technical condition is perfect.
4. Adhering to the operating instructions and the general safety instructions.
5. Adhere to country or user specific regulations.
6. The digital display is not intended for use in areas with risks of explosion and in the branches excluded by the standard EN 61010 Part 1.
7. The digital display shall only operated if it has been correctly mounted in a panel, in accordance with the chapter "Main technical features".

1.1 Use according to the intended purpose

The digital display may be used only as a panel-mounted device. Applications of this product may be found in industrial processes and controls, in manufacturing lines for the metal, wood, plastics, paper, glass, textile and other processing industries.

Over-voltages at the terminals of the digital display must be kept within the limits in Category II

If the digital display is used to monitor machines or processes in which, in case of a failure of the device or an error made by the operator, there might be risks of damaging the machine or causing accidents to the operators, it is your responsibility to take appropriate safety measures.

2. Technical Data

2.1 Miscellaneous Data

Display	5 digit red LED, 14.2 mm high
Display range	-19999 ... 99999, with leading zeros suppression
Out of range Indication	Under-range uuuuu / Over range ooooo
Data storage	EEPROM, 1 Million storage cycles or 10 Years
Test voltage	EN 61010 Part 1 ; overvoltage category 2, Test voltages level 2
EMC	Interference emissions EN 50081-2 / EN 55011 Class B Interference resistance EN 61000-6-2

2.2 Electrical Data

2.2.1 Power supply

AC power supply	90 ... 260 V AC/max. 6 VA external fuse 100 mA/T
DC power supply	10 ... 30 V DC, max. 2 W, galvanically isolated with inverse polarity protection external fuse 250 mA/T
Mains Hum Filter	digital filter 50 Hz or 60 Hz, programmable

2.2.2 Inputs

Measurement ranges

Thermocouples	Ranges	Accuracy
Type B	400,0 °C ... 1820,0 °C	± 1,5 °C
E	-200,0 °C ... 1000,0 °C	± 0,5 °C
J	-210,0 °C ... 1200,0 °C	± 0,5 °C
K	-200,0 °C ... 1372,0 °C	± 0,5 °C
N	-200,0 °C ... 1300,0 °C	± 0,5 °C
R	-50,0 °C ... 1760,0 °C	± 1,0 °C
S	-50,0 °C ... 1767,0 °C	± 1,0 °C
T	-210,0 °C ... 400,0 °C	± 0,5 °C
Resolution	0,1 °C (0,1 °F)	
Cold-junction compensation	internal or external (programmable)	

Input for resistance thermometers (RTD probes)

Resistance thermometer	Ranges	Accuracy
Type Pt100	-200,0 °C ... 800,0 °C	± 1,0 °C
Pt1000	-200,0 °C ... 800,0 °C	± 1,0 °C
Resolution	0,1 °C (0,1 °F)	
Type	2 wire, 3 wire and 4 wire technology, programmable	
Current	800 µA at Pt100 80 µA at Pt1000	

Input for resistance

	Ranges	Accuracy
Resistance	0 ... 400 Ω	$\pm 0,2 \%$
Resistance	0 ... 4000 Ω	$\pm 2,0 \%$
Resolution	14 bit	
Measurement mode	2 wire, 3 wire and 4 wire technology, programmable	
Current	800 μ A at 400 Ω 80 μ A at 4000 Ω	

Voltage measurement

	Ranges	Accuracy
Voltage	0 .. +100 mV DC	$< 0,1\% \pm 1$ Digit
Voltage	-100 .. +100 mV DC	$< 0,1\% \pm 1$ Digit
Resolution	14 bit	
Input resistance	> 2 M Ω	

Further data for the measurement input

A/D transducer	Dual-Slope
Measuring speed	approx.. 1 measurement/sec
Zero adjustment	automatically

Digital input

Input MPI*	Function of the input depends on set-up to stop the instantaneous value
1. Function: Display-Hold	Reset the alarm value
2. Function: Reset Alarm Latch	

*Multi Purpose Input

Input Key Keypad lock-out of alarm settings

Switching level	
logical 0	0 ... 2 V DC
logical 1	4 ... 30 V DC

Min. pulse duration > 5 ms

The MPI Input is galvanically isolated from the rest of the unit's electronics

2.2.3 Outputs

Alarm 1/Alarm output 2

Relay output with volt-free changeover contacts

can be setup as normally closed or normally open

Switching voltage 250 V AC/300 V DC

Switching current max. 3 A AC/DC, min. 30 mA DC

Switching power 2000 VA / 50 Ω

or **NPN-optocoupler** with open collector and open emitter

Switching power	30 V DC/15 mA
UCEsat at Ic = 15 mA	max. 2.0 V DC
UCEsat at Ic = 5 mA	max. 0.4 V DC

Auxiliary power supply output for measuring transducer/sensor

AC models voltage output 10 V DC $\pm 2\%$, 30 mA
and

DC models only voltage output 10 V DC $\pm 2\%$, 30 mA

The auxiliary power supply is galvanically isolated from the inputs, outputs and the interface.

2.3 Mechanical Data

Housing	Housing for control panel 96 x 48 mm according to DIN 43 700, RAL 7021
Dimensions (W x H x D)	96 x 48 x 90 mm
Panel cut-out (B x H)	92 ^{+0.8} x 45 ^{+0.6} mm
Mounting depth	approximately 83 mm
Weight	approximately 220 g
Protection	IP 65 (on the front side)

Connections

Power supply and output:	1 x screw terminal, 8-pole, RM 5.08
Measurement and control input:	1 x screw terminal, 11-pole, RM 3.81
Interfaces:	(*) 1 x screw terminal, 5-pole, RM 3.81

Cleaning: The front of the unit is only to be cleaned with a soft wet (water !) cloth.

* only with interface option

2.4 Environmental conditions

Ambient temperature	-20°C ... +65°C
Storage temperature	-40°C ... +85°C
Climatic stability	relative humidity < 75%, without condensation

2.5 Delivery includes:

- Process display
- Screw terminal, 8-pole, RM 5.08
- Screw terminal, 11-pole, RM 3.81
- Screw terminal, 5-pole, RM 3.81(*)
- Clamping bracket
- Gasket
- Multilingual operating instructions
- 1 set of self-adhesive symbols

* only with the interface option

2.6 Order code

230 V AC: KT-LED-96-2R-230VAC

24 V DC: KT-LED-96-2R-24VDC

3. Mounting

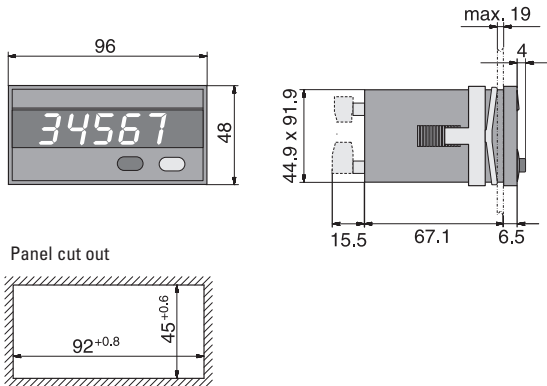

4. Electrical Connections

View of rear of unit

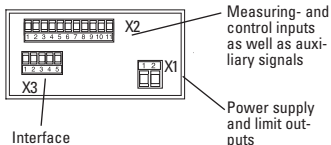

Warning: for 90 ... 260 V ACversion. Please apply the power supply after the complete installation. Danger of Death! Please check

unit label before applying the power supply.

4.1 Messeingänge

4.1.1 Thermocouples

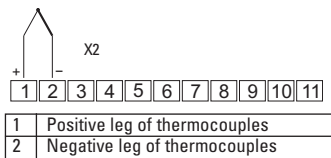

4.1.2 Resistance measurement Pt100 or 0 ... 400 Ω

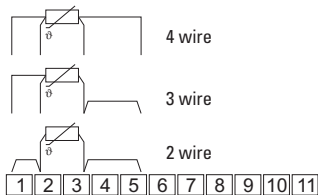

4.1.3 Resistance measurement Pt1000 or 0 ... 4000 Ω

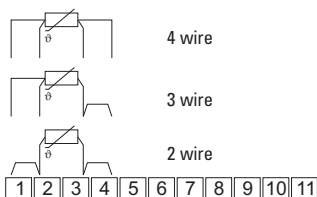

4.1.4 Voltage measurement 0 ... 100 mV, or -100 ... 100 mV

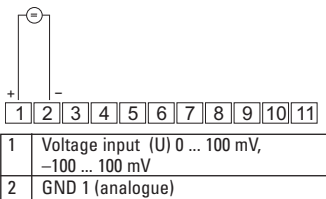

4.2 Control Inputs and Auxiliary Signals (U_{out})

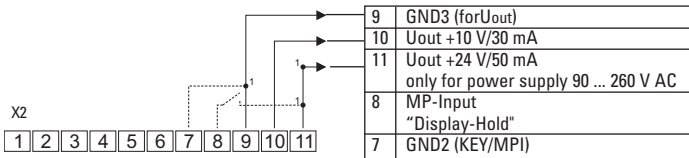

1 Alternatively connect directly to DC supply
(galvanic separation of control and measurement inputs)

4.3 Power supply and alarm outputs

Relay output

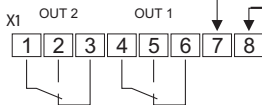

	DC voltage	AC voltage
7	10 ... 30 V DC	90 ... 260 V AC (N~)
8	GND4 (0 V DC)	90 ... 260 V AC (L~)



Warning: at 90 ... 260 V AC version.
Please apply the power supply
after the complete installation.
Danger of Death! Please check
unit label before applying the power supply.

Optocoupler output

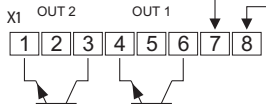

5 Parameter setup

The parameters have to be set up before putting the unit into operation.

– Input parameter



The parameters of the scaling slope must be set up depending on the sensor used.

– Scaling scope

The correspondence between the input signal and the displayed value is given by the scaling slope. The scaling slope is set up by entering pairs of values.

5.1 Setup Mode

To put the unit into set-up mode

1. keep the  key pressed
2. connect the unit with the power supply
3. When the display shows  release the key.

Getting acquainted with the displays and keys

The selection or the settings can be run through as often as required thanks to the step-through programming method

Menu item:

The display alternates every 2 seconds between

Menu	<->	Selection
		

Where negative values are permitted, the highest digit will switch from “9” to “-” and only then to “0”.

Press key  to switch to the next digit.

– Alarms/outputs

Either none, one or two alarm values can be active. Hysteresis and output parameters are also set up. If the set-point is exceeded, a signal will be sent out at the corresponding output and the corresponding LED will be switched on.

The alarms themselves are set up in the operating mode!

– Mains Hum Filter

To reduce operational interference caused by the 50/60 Hz mains supply you can choose the local mains frequency.

Entering into the menu:



Either a selection has to be made or a value has to be set up.

Press the  key. The display stops alternating.

– Making a selection:

Pressing the  key displays all the possible settings one after the other.

– Enter the selection:

Press the  key. The selected parameter will be stored. The next menu item appears 

– Entering a value:

The flashing digit indicates that it is enabled for entry.

Press the  key, the number will be incremented.

Enter value: Press key , the value will be stored. The next menu item appears.

5.2 Input Parameters for Instantaneous value

All set-ups related to the input signal and the corresponding displayed value are

carried out here. The displayed value is displayed from the input signal via the scaling slope.

5.2.1 Select range for the input signal

Menu <-> Selection

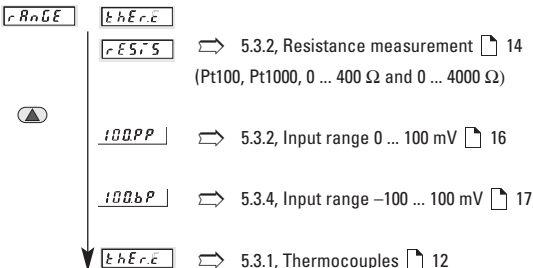

press key to accept the selection

5.3 Select the input signal

Menu <-> Selection



press the keys to accept the selection

5.3.1 Thermocouples

5.3.1.1 Select Type of Thermocouples

Menu <-> Selection

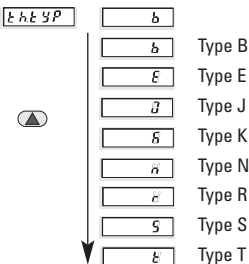

For the thermocouples specified here, scaling slopes with 24 pairs of values are stored in the unit. Intermediate input values between the stored pairs of values are linearly interpolated.

press key to accept the selection

5.3.1.2 Display unit

The selection made here is also used for the cold junction compensation and for the correction (offset) value.

Menu <-> Selection

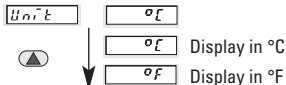

press key **P** to accept the selection

5.3.1.3 Cold junction compensation

The temperature measured by the thermocouple can be compensated either by the temperature measured internally in the unit (int.) or by an external reference value. In addition, a correction value can be added. The unit takes this value into account and displays the result.

Menu <-> Selection

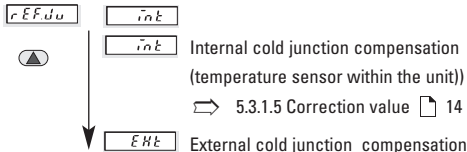

press key **P** to accept the selection

5.3.1.4 Adjust the cold junction compensation

Entry of the known value of an external reference, to one decimal point.

Menu <-> Select

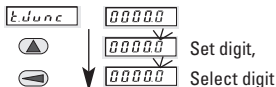

press key **P** to accept the selection

5.3.1.5 Correction value

Entry of a correction (offset) value, by which the measured value will be adjusted. The value will be added to the measured value. Positive as well as negative correction values are possible. The entry is always carried out to one decimal point.

Menu \leftrightarrow Select

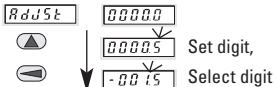

press key **P** to accept the selection

Assuming the measured value is 28.45 and the correction value is -1.5, the display will indicate 26.95 .

5.3.2 Resistance Measurement

Menu \leftrightarrow Selection



press key **P** to accept the selection

Also suitable for non-linear resistances

5.3.2.1 Select Measuring Mode

Menu \leftrightarrow Selection

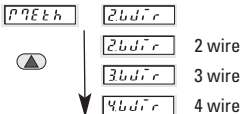

press key **P** to accept the selection

\Rightarrow 4. electrical connections  9

5.3.2.2 Measurement range

Menu <-> Selection

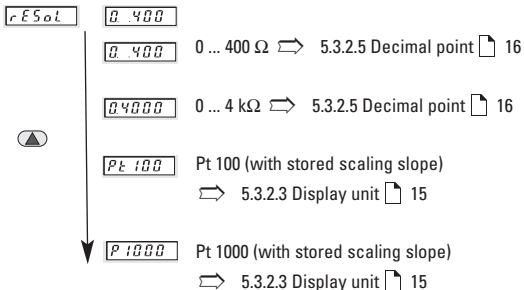

press key P to accept the selection

5.3.2.3 Display Unit (Pt100, Pt1000)

Menu <-> Selection

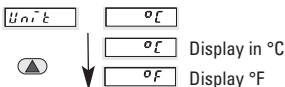

press key P to accept the selection

5.3.2.4 Correction value (Pt100, Pt1000)

Entry of a correction (offset) value, by which the measured value will be adjusted. The value will be added to the measured value. Positive as well as negative correction values are possible. The entry is always carried out to one decimal point.

Menu <-> Selection



press key P to accept the selection

Assuming the measured value is 28.45 and the correction value is -1.5, the display indicates 26.95.

5.3.2.5 Decimal Point (400 Ω/4000 Ω)

Menu ↔ Selection

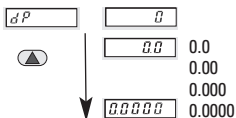

Please note:

The decimal point is only visual. It influences neither the measuring accuracy nor the actual resolution, that means for example, shifting 2 digits left results in a display in unit of hundreds.

After the decimal point is set up, the leading zeros will be suppressed.

press key P to accept

5.3.2.6 Changing the scaling scope (400 Ω/4000 Ω)

Menu ↔ Selection

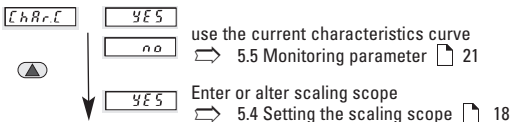

press key P to accept the selection

5.3.3 Input range 0 ... 100 mV DC

Menu ↔ Select



press key P to accept the selection

5.3.3.1 Decimal Point for Displayed Value

Menu ↔ Selection

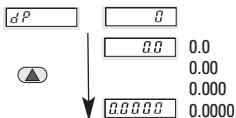

Please note:

The decimal point is only visual. It influences neither the measuring accuracy nor the actual resolution, that means for example, shifting 2 digits left results in a display in unit of hundreds.

After the decimal point is set up, the leading zeros will be suppressed.

press key P to accept the selection

5.3.3.2 Changing the Scaling slope

Menu ↔ Selection

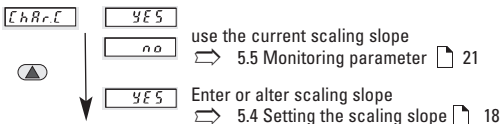

press key P to accept the selection

5.3.4 Input range -100 ... 100 mV DC, bipolar

Menu <-> Selection

rRnGE 100bP

press key **P** to accept the selection

5.3.4.1 Select Decimal Point

Menu <-> Selection

dP 0
00 0.0
0.00 0.00
0.000 0.000
0.0000 0.0000

Please note:

The decimal point is only visual. It influences neither the measuring accuracy nor the actual resolution, that means for example, shifting 2 digits left results in a display in unit of hundreds.

After the decimal point is set up, the leading zeros will be suppressed.

press key **P** to accept the selection

5.3.4.2 Changing the Range Limits

The given limits for the input range can be entered as is, or adjusted.

	Parameter L o i n P	Parameter h r i n P
	Possible range of values	Possible range of values
0 ... 100 mV	not adjustable 0.0	not adjustable 100.0
-100 ... 100 mV	-100.00 ... 100.00	-100.00 ... 100.00

If the measured signal falls below or exceeds the programmed value, then the display alternates between L o and the measured value or between h r and the the measured value.

Setting values out of the range is not possible. It is only possible to continue with the set-up, using the **P** keys, when the settings are correct.

Lower Limit

Menu <-> Selection

L o i n P 10000 Example.: -50,00
10000 Select digit
-0000 Set digit
-0000 Select digit
-5000 Set digit

When the input signal falls below the value set here, then L o will be displayed

Under-range: When the input signal falls below -135 mV, then uuuuu will be displayed.

press key **P** to accept the selection

Upper limit

Menu <-> Selection

h⁻lnP 10000 Example: 80.000
10000 Select digit
00000 Set digit

When the input signal exceeds the value set here, than h⁻ is displayed.

Over-range: When the value exceeds 109 mV then 00000 is displayed.

press key P to accept the selection

5.3.4.3 Changing the scaling slope

Menu <-> Selection

[h R r L] y E 5
n o use the current scaling slope
y E 5 Setting the scaling slope

⇒ 5.5 Monitoring parameter 21
⇒ 5.4 Monitoring parameter 18

press key P to accept the selection

5.4 Setting the Scaling Slope

At least two points (2 pairs of values) are required for the start point and end point of the scaling slope. This slope can be rising or falling. A maximum of 24 scaling points can be used.

The scaling slope must lie within the limits of the input and display ranges. The first and last points can lie on the limits.

However it should be noted that in all cases, whether the slope rises or falls, the values that are inputted (Inp.01 ... InP.24) must increase sequentially.

Input range -100 ... +100 mV

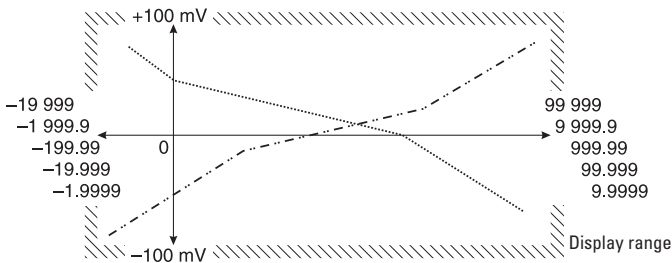

Example with 4 scaling points

Input range -100 ... +100 mV

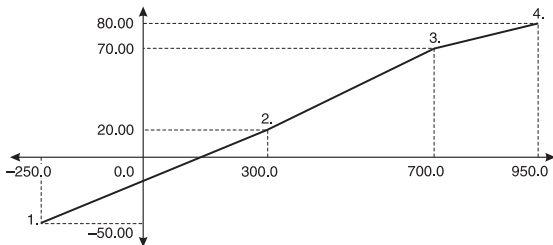

knee points	input-value	display value
1	-50,000	-250,0
2	20,000	300,0
3	70,000	700,0
4	80,000	950,0

It is recommended to note down the required pairs of values for the scaling points of the slope before starting the set-up.

We will use this example in the following pages

5.4.1 Enter the number of scaling points

Menu ↔ Selection

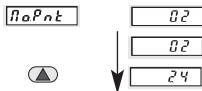

Example: 2
Pressing the key will increment the value by one.
After reaching 24 the value jumps back to 2.

press key to accept the selection

5.4.2 Define first scaling point

Firstly set the input value for the start of the slope using the respective unit (mA, V)

Then set the display value for the start of the slope

Menu ↔ Selection

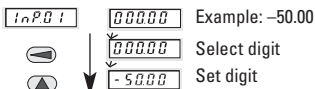

press key to accept the selection

Menu ↔ Selection

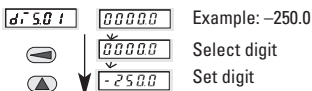

press key to accept the selection

5.4.3 Define second scaling point

Menu ↔ Selection



press key to accept the selection

Set display value

Menu ↔ Selection



press key to accept the selection



5.4.4 Define further scaling points

Additional scaling points will be requested only, when in section 5.3.1 more than 2

scaling points are defined.

5.5 Alarms/Alarm outputs

One, two or no alarms can be active.

When exceeding	Signal on	LED display
Alarm 1	Output 1	 1 on
Alarm 2	Outout 2	 2 on

5.5.1 Alarm 1/Alarm output 1

5.5.1.1 Alarm 1 off/on

Menu \leftrightarrow Selection

  Example: on





Example: on

Alarm 1 not active \Rightarrow Chapter 5.5.2  24



Alarm 1 active

press the  key to accept the selection

5.5.1.2 Mode for Alarm output 1

Menu \leftrightarrow Selection





Latch mode, Latch signal reset at output 1

\Rightarrow Chapter 5.5.1.4  23



Auto mode

press the  key to accept the selection

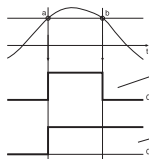

Alarm a: threshold exceeded
b: below threshold

Output mode "Auto": automatic resetting of output when the signal falls below threshold, signal set to 0, LED extinguished.

Output mode "Latch": Manual and/or electrical resetting of signal and LED

5.5.1.3 Alarm 1 Hysteresis

Here hysteresis means: The difference in thresholds between switching on and switching off. This difference should be selected large enough to avoid undesired switching actions at the output due to the variations of the current instantaneous value.

Note:

Alarm value and hysteresis are always based on the displayed current value and not on the input signal value.

For positive alarm value:

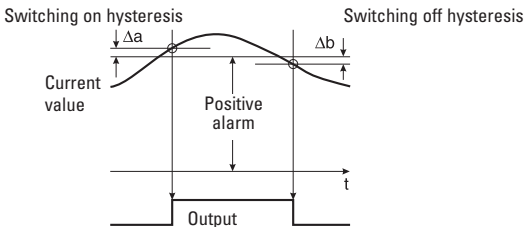

Switching on value = alarm + switching on hysteresis Δa

Switching off value = alarm - switching off hysteresis Δb

The switching on value **must be greater** than the switching off value.

For negative alarm value:

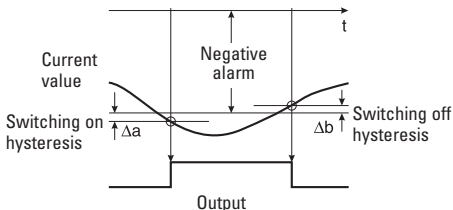

Switching on value = alarm - switching on hysteresis Δa

Switching off value = alarm + switching off hysteresis Δb

The switching on absolute value (numerical value without sign) **must be greater** than the absolute value for switching off.

Set switching on hysteresis Δa for alarm 1

Menu \leftrightarrow Selection

o.n.h.y.i **000000** Example 1.0

000000 Select digit

000 10 Set digit

press the key to accept the selection

Set switching off hysteresis Δb for limit 1

Menu \leftrightarrow Selection

o.f.h.y.i **000000** Example: 1,0

000000 Select digit

000 10 Set digit, then select signal form for output 1, Chapter 5.5.1.5 23

press the key to accept the selection

5.5.1.4 Reset Latch signal at output 1

Menu \leftrightarrow Selection

r.o.u.t.i **r.r.r.n**

r.r.r.n Manual reset with red key

Alarm output can only be reset manually if or is selected as the function and is displayed.

l.l.l.c.t Electrical reset with MPI-Input

Alarm output can only be reset electrically, if or is selected as the function and is displayed.



l.l.p.r.r Both manual and electrical reset

press the key to accept

Alarm output can either be reset manually via the red key or via a reset pulse on the MP input.

Note: The Display Hold function is off.

5.5.1.5 Select Signal Form for Output 1

Menu \leftrightarrow Selection

o.u.t.i **..f--**

..f-- Positive output signal

Output is **activated**, when the instantaneous value \geq alarm 1

..l.. Negative output signal

Output is **deactivated**, when the instantaneous value \geq limit 1.





press the

5.5.2 Alarm 2/Alarm output 2

5.5.2.1 Alarm2 on / off

Menu <-> Selection



  Example: on

  Alarm 2 not activated,  Chapter 5.6,  25

  Alarm 2 not activated, press the  key to accept the selection

5.5.2.2 Mode for Alarm output 2

Menu <-> Selection

  Example: on

  Reset Latch mode, Latch signal at output 2
 Chapter 5.5.2.4,  25

  Auto mode

press the  key to accept the selection

5.5.2.3 Hysteresis for Alarm 2

Set switching on hysteresis Δa for Alarm 2

Menu <-> Selection

  Select digit



  Set digit

press the  key to accept the selection

Set switching off hysteresis Δb for Alarm 2

Menu <-> Selection

  Select digit

  Set digit  Chapter 5.5.2.5 select signal for output 2

press key  to accept

5.5.2.4 Reset Latch signal at Output 2

Menu ↔ Selection

LRtch **PRRn**

PRRn

Manual reset with red key 

Alarm output can only be reset manually if **RCt**, **PRi~n** or **PRRH** is selected..

EEEt

Electrical reset with MPI-Input

Alarm output can only be reset electrically, if **RCt**, **PRi~n** or **PRRH** is selected as the function and is displayed.

Note: The Display Hold funktion is off.

ELPRR

Both, manual and electrical reset

Alarm output can either be reset manually via the red key or via a reset pulse on the MP input.

Note: The Display Hold funktion is off.

press the **P** key to accept

5.5.2.5 Select signal form for output 2

Menu ↔ Selection

Out1 **..f--**

..f--

Positiv output signal

Output is **activated**, when the instantaneous value \geq limit 2

..t..

Negativ output signal

Output is **deactivated**, when the instantaneous value \geq limit 2.

press the **P** key to accept

5.6 MIN/MAX value acquisition

The maximum value may be captured, saved and consulted during operation by pressing a key.

5.6.1 Monitor maximum values

Menu ↔ Selection

PRRH **4E5**

Example: Yes

no

will not be monitored → 5.6.2,  26

4E5

will be monitored and stored

press the **P** key to accept the selection

5.6.1.1 Reset maximum value

Menu <-> Selection

r.P98H

YES

Example: Yes



no

cannot be reset



YES

can be reset with the key.

The MIN value can only be cleared by pressing the red key. In addition "MIN" must be selected as the display source. In parameter set-up "r.MIN" must be programmed as "YES"

press the key

5.6.2 Monitor minimum value

Menu <-> Selection

r.r.n

YES

Example: Yes



no

will not be monitored 5.7, 26



YES

will be monitored and stored

press the key to accept the selection

5.6.2.1 Reset minimum value

Menu <-> Select

r.P9i.n

YES

Example: Yes



no

Cannot be reset



YES

Can be reset with the key .

The MAX value can only be cleared by pressing the red key. In addition "MAX" must be selected as the display source. In parameter set-up "r.MAX" must be programmed as "YES"

press the key to accept the selection

5.7 Mains Hum Filter

To reduce the interference from mains line and the environment (mains hum), the instrument must be set to the local mains frequency.

Menu <-> Selection

F.L.F.F

50 Hz



60 Hz

local power line 60 Hz



50 Hz

local power line 50 Hz

press the key to accept the selection

5.8 Setting Default Values

The user has the possibility to set all parameters back to their default values by using the parameter **dEFC**. This parameter **dEFC** must be programmed with the value **07049**. If you then proceed to the next parameter using the keys,

then all parameters are reset to their default values. It is not necessary to finish the programming; a new programming cycle can take place immediately.

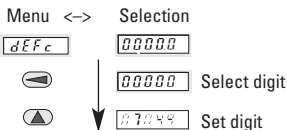

press the **P** key to accept the selection

5.9 End of Setup yes / no ?

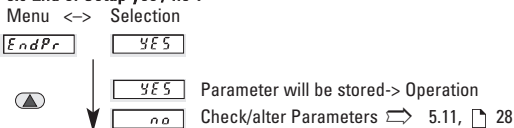

press the **P** key to accept the selection

5.10 Check/Alter Parameters

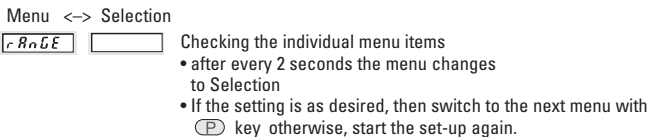

6 Operation

The unit is in the operating mode, when the power supply is switched on or at the end of the setup.

One of the following will be displayed

326.8 i

326.81 The measuring signal has been applied and lies within the limits of the measuring range. The display will show either the current

measured value, the MAX value or the MIN value.

Lo

The input value is below the lower limit of the measuring range. This display alternates with the measured value display.

hi

The input value signal is higher than the upper limit of the measuring range. This display alternates with the measured value display

uuuuu

The input value is below the minimum permitted value.

ooooo

The input value is higher than the maximum permitted value.

6.1 Changing the Display during Operation

Pressing the P key once for 2 sec will identify the function currently selected. If within these 2 sec the P key is pressed again, then the display will proceed to

the next display function. The new identification will be displayed for 2 sec to confirm this. After 2 sec the corresponding value of the selected function will be displayed.

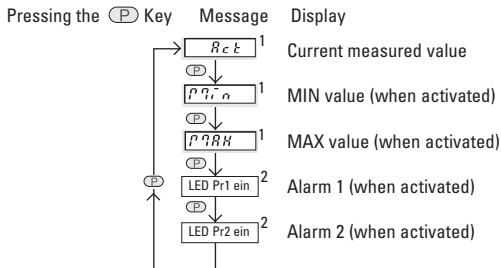

¹Following actuation the corresponding value of the chosen function remains in the display. During a PowerOff the function currently selected will be saved. At the next PowerOn the corresponding value of this function will be shown again

in the display.
²After 4 sec the display automatically switches back to the current measured value and the LED indicators Pr1 or Pr2 are turned off.

Note:

When an alarm value is shown in the display, its set value can be changed.

This can be prevented by disabling the panel keys using the "Key" lock.

6.2 Setting the Alarms during Operation

When an alarm value is shown in the display, its set value can be changed.

Alarm 1 is displayed. LED 'Pr1' is illuminated

Display



Action



Select digit position and set digit.



Example: 300.0

press the  key to accept and go to Alarm 2

Alarm 2 is displayed. LED 'Pr2' is illuminated

Set Alarm

Display



Action



Select digit position and set digit.



Example 800.0

press the  key to accept the selection

Set Alarm

Note: the "key-lock" should not be enabled.

6.3 Resetting MIN/MAX value

Resetting is only possible if this has been enabled in the parameter mode.

Select Min/Max value display

- press the red key.
- the stored value is cleared

6.4 Display Hold

The Display Hold function is only available for use with the current measured value and for the totalizer value.

For as long as a high level signal (> 4 V DC) is present at the MP input,

then the display is "frozen".

The MIN/MAX capture, alarm monitoring and totalizer functions continue in the background.

The Display Hold function is only active with the following parameter settings:

	Parameter	Settings
Alarms	<code>prES1</code> / <code>prES2</code>	<code>off</code>
Alarms	<code>prES1</code> / <code>prES2</code>	<code>on</code>
Output Mode	<code>prOU1</code> / <code>prOU2</code>	<code>latch</code>
Alarms	<code>prES1</code> / <code>prES2</code>	<code>on</code>
Output Mode	<code>prOU1</code> / <code>prOU2</code>	<code>latch</code>
Reset-Alarm-Latch	<code>reset1</code> / <code>reset2</code>	<code>prRN</code>

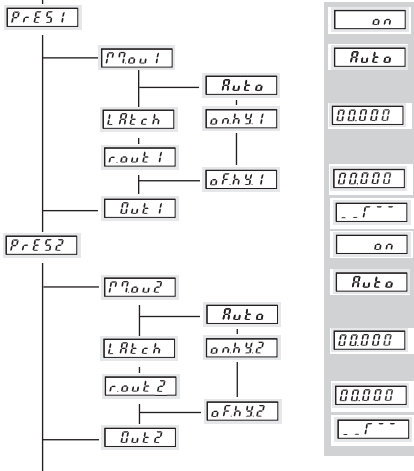
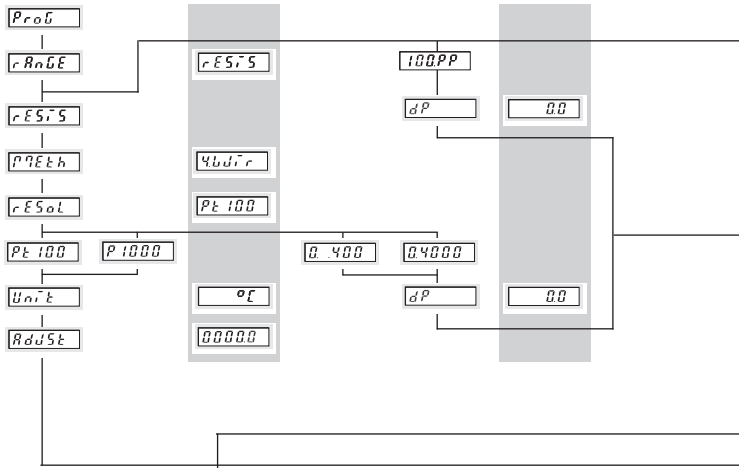

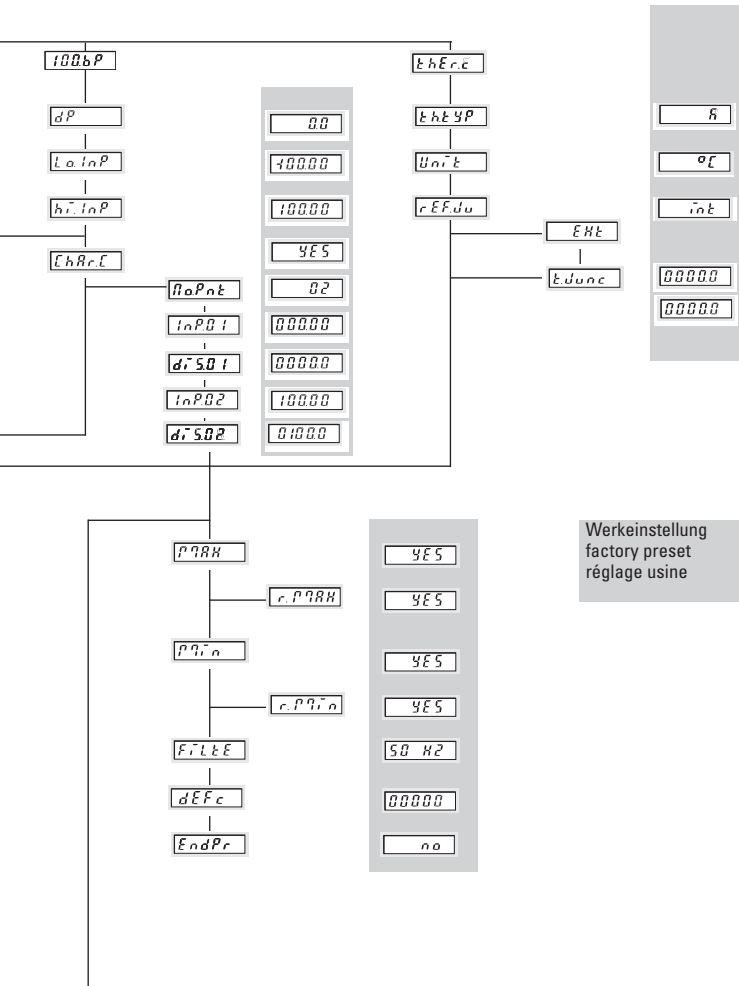

Werkeinstellung
factory preset
réglage usine



FACTORY AUTOMATION – SENSING YOUR NEEDS

For half a century, Pepperl+Fuchs have been continually providing new stimuli for the world of automation. The company is also setting standards in quality and innovative technology. We develop, produce and distribute electronic sensors and interface modules on a global scale. By means of our world-wide presence and our high flexibility in production and customer service we are able to individually offer complete solutions – right where you need us. We know what we are talking about – Pepperl+Fuchs have established a good reputation in supplying the world's biggest offer of industrial sensor technology for a large scale of applications. **Our signals move the world.**

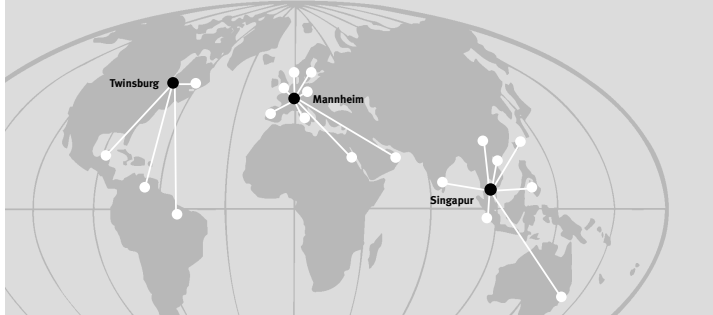

Worldwide Headquarters

Pepperl+Fuchs GmbH
68307 Mannheim · Germany
Tel. +49 621 776-0
E-Mail: info@de.pepperl-fuchs.com

USA Headquarters

Pepperl+Fuchs Inc.
Twinsburg, Ohio 44087 · USA
Tel. +1 330 4253555
E-Mail: sales@us.pepperl-fuchs.com

Asia Pacific Headquarters

Pepperl+Fuchs Pte Ltd. · P+F Building
Singapore 139942
Tel. +65 6779-9091
E-Mail: sales@sg.pepperl-fuchs.com

PF **PEPPERL+FUCHS**
SENSING YOUR NEEDS



www.pepperl-fuchs.com

Subject to reasonable modifications due to technical advances
Copyright PEPPERL+FUCHS • Printed in Germany

KT-LED-96-2R-230VAC
KT-LED-96-2R-24VDC
R.60011.9393
02/2009