

QUICK START GUIDE

IC-KP-^{*} IDENTControl units



CE

With regard to the supply of products, the current issue of the following document is applicable: The General Terms of Delivery for Products and Services of the Electrical Industry, published by the Central Association of the Electrical Industry (Zentralverband Elektrotechnik und Elektroindustrie (ZVEI) e.V.) in its most recent version as well as the supplementary clause: "Expanded reservation of proprietorship"

1	Introduction.....	4
1.1	Purpose of this quick start guide	4
1.2	Product documentation on the internet.....	4
2	Product Description	5
2.1	Product family	5
2.2	Connection accessories.....	5
2.2.1	Connection cable for R/W heads and trigger sensors	5
2.2.2	Cable connectors for the power supply	6
2.2.3	Network cable to the Ethernet interface	7
2.2.4	Connection cable to the PROFIBUS DP interface	8
2.2.5	Connection cable to the serial interface.....	9
3	Installation.....	10
3.1	Contact protection.....	10
3.2	Interface connections.....	10
3.2.1	Serial interfaces.....	10
3.2.2	Ethernet connection guide	11
3.2.3	INTERBUS connection guide	13
3.2.4	PROFIBUS connection guide	14
3.2.5	DeviceNet connection guide	16
3.2.6	Command Interface connection guide	17
3.3	Power supply	18
3.4	Read/Write Head and Trigger Sensors.....	19
3.5	Cable length between control interface and R/W heads.....	19
3.6	Ground connection	19
4	Commissioning.....	20
4.1	Connection	20
4.2	Setting the IP address.....	20
5	Technical Specifications.....	21
5.1	Dimensions.....	21

1 Introduction

1.1 Purpose of this quick start guide

This quick start guide contains basic instructions for operating the device. However, the manual takes priority over the quick start guide.

1.2 Product documentation on the internet

You can view all the relevant documentation and additional information on your product at <http://www.pepperl-fuchs.com>. Simply enter the product name or model number in the **Product/Key word search** box and click **Search**.



Select your product from the list of search results. Click on the information you require in the product information list, e.g., **Technical documents**.



A list of all available documents is displayed.

2 Product Description

2.1 Product family

The brand name IDENTControl represents a complete identification system. The system consists of an IDENTControl control interface with bus interface, inductive read/write heads (125 kHz and 13.56 MHz), read/write heads with electromagnetic coupling (UHF with 868 MHz) and the associated read only and read/write tags in a number of different designs. IDENTControl is open and can be connected to other identification systems.

2.2 Connection accessories

2.2.1 Connection cable for R/W heads and trigger sensors

Compatible connection cables with shielding are available for connecting the R/W heads and trigger sensors.



Figure 2.1

Accessories	Description
2 m long (straight female, angled male)	V1-G-2M-PUR-ABG-V1-W
5 m long (straight female, angled male)	V1-G-5M-PUR-ABG-V1-W
10 m long (straight female, angled male)	V1-G-10M-PUR-ABG-V1-W
20 m long (straight female, angled male)	V1-G-20M-PUR-ABG-V1-W
Field attachable female connector, straight, shielded	V1-G-ABG-PG9
Field attachable male connector, straight, shielded	V1S-G-ABG-PG9
Field attachable female connector, angled, shielded	V1-W-ABG-PG9
Field attachable male connector, angled, shielded	V1S-W-ABG-PG9
Dummy plug M12x1	VAZ-V1-B3

2.2.2 Cable connectors for the power supply

Compatible M12 sockets with an open cable end for connecting the IDENTControl to a power supply are available in different lengths.

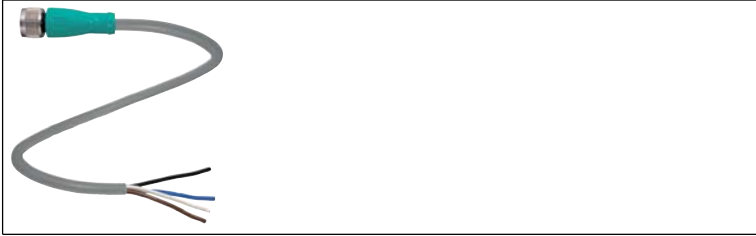

Figure 2.2

Accessories	Designation
Length 2 m (straight socket)	V1-G-2M-PUR
Length 5 m (straight socket)	V1-G-5M-PUR
Length 10 m (straight socket)	V1-G-10M-PUR

The IDENTControl IC-KP-B17-AIDA1 is connected to the power supply via a connector that complies with the AIDA directive.

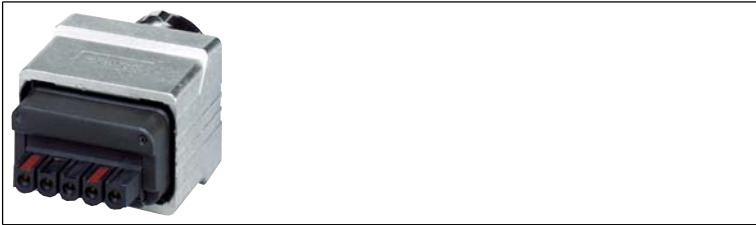

Figure 2.3

Accessories	Designation
Field attachable connector for power supply	ICZ-AIDA1-MSTB
MSTB connecting cable to M12 connector	ICZ-AIDA1-MSTB-0.2M-PUR-V1-G
MSTB connecting cable to open cable end	ICZ-AIDA1-MSTB-5M-PUR

2.2.3 Network cable to the Ethernet interface

The IDENTControl IC-KP-B12-V45 is connected to the network via an RJ45 socket. An RJ45 connector seal compatible with the Ethernet network cable is available for mobile applications in accordance with IP67.



Figure 2.4

Accessories	Designation
IP67 network connector seal	ICZ-V45
Network cable RJ45, category 5, up to 100 MHz, 10 m	V45-G-10M-V45-G

2.2.4 Network Cable to the Ethernet Interface

The IDENTControl IC-KP-B17-AIDA1 is connected to the network via a connector that complies with the AIDA directive.



Figure 2.5

Accessories	Designation
Field attachable connector for RJ45	ICZ-AIDA1-V45
RJ-45 connecting cable, D-coded to M12	ICZ-AIDA1-V45-0,2M-PUR-V1D-G
Stopping plugs	ICZ-AIDA1-B

Connector Assignment

Signal	Marking on connector
TD+	Yellow
TD-	Orange
RD+	White
RD-	Blue

2.2.5 Connection cable to the PROFIBUS DP interface

The IDENT Control has a B-encoded M12 connector and is connected to the network using a suitable cable.

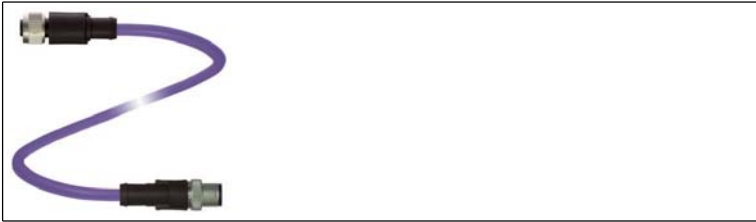

Figure 2.6

Accessories	Description
Terminator	ICZ-TR-V15B
T distributor	ICZ-3T-V15B
Y connection cable	ICZ-3T-0.2M-PUR ABG-V15B-G
Connection cable with terminator	ICZ-2T/TR-0.2M-PUR ABG-V15B-G
Connection cable 1 m ¹	V15B-G-1M-PUR ABG-V15B-G
Cable socket, screw terminal type	V15B-G
Cable plug, screw terminal type	V15SB-G

1. Connection cables are available in the following lengths:
1 m, 2 m, 5 m, 7 m, 12 m, 15 m.



Note!

The T-distributor is designed for general applications in the PROFIBUS network only and is not compatible with the IDENT Control. The Y connection cable must always be used with the IDENT Control.

2.2.6 Connection cable to the serial interface

The IDENT Control IC-KP-R2-V1 has an M12 connector and is connected to the host using a suitable cable.

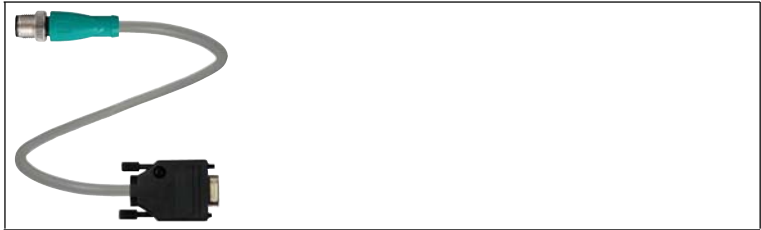

Figure 2.7

Accessories	Designation
M12 cable connector, shielded, field-attachable	V1S-G-ABG-PG9
Adapter cable, M12 to Sub-D (for connection to a PC using a null modem cable)	V1S-G-0.15M-PUR-ABG-SUBD
Null modem cable Sub-D	IVZ-K-R2

3 Installation

3.1 Contact protection

Our housings are manufactured using components made partly or completely from metal to improve noise immunity.

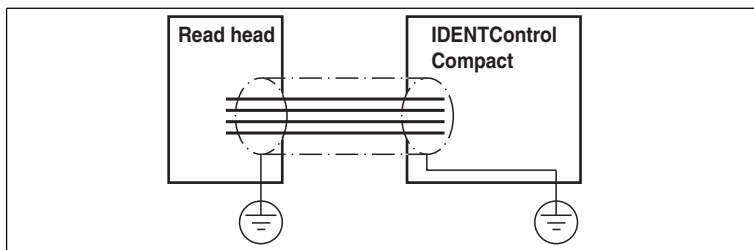

Danger!

Electric shock

The metallic housing components are connected to ground to protect against dangerous voltages that may occur in the event of a fault in the SELV power supply!

3.2 Interface connections

3.2.1 Serial interfaces

Connect the **RS 232** interface with the M12 socket. You must place the cable shield on the thread in the connector plug.



Pin assignment of the M12 socket for RS 232

- 1 NC
- 2 RxD
- 3 GND
- 4 TxD
- 5 NC

3.2.2 Ethernet connection guide

IC-KP-B12-V45:

Network connection

The network is connected via an RJ45 connector. The following illustration shows the pin assignment:

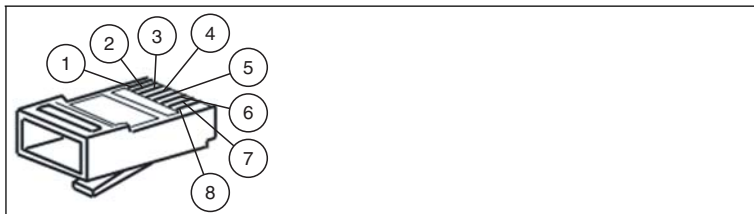

- 1 TD+
- 2 TD-
- 3 RD+
- 4 Not used
- 5 Not used
- 6 RD-
- 7 Not used
- 8 Not used



Caution!

The RJ-45 network socket is connected galvanically to the grounded housing. The Ethernet/IP specification does NOT require the use of Ethernet cables with a shield connected to the RJ-45 plug at both ends. However, we recommend using cables with a continuous shield only, in order to avoid EMC issues.

Transfer rates, line lengths and line types

The device can be operated in 10 Base-T or 100 Base-TX networks. The maximum total line length is 100 m in both cases and only shielded network cables from category 5 or above can be used. Compatible connecting cables see chapter 2.2.3.

IC-KP-B17-AIDA1:

Network connection

Connect the network to the IDENTControl using a connector that conforms with AIDA. Two sockets with the following pin assignment are located on the housing:



- TD+
- TD-
- RD+
- Not used
- Not used
- RD-
- Not used
- Not used



Caution!

The network socket is connected galvanically to the grounded housing. The Ethernet/IP specification does NOT require the use of Ethernet cables with a shield connected to the RJ-45 plug at both ends.

However, we recommend using cables with a continuous shield only, in order to avoid EMC issues.



Note!

Protection degree IP67

If you use only one of the two network connections, you must close the unused network port with the blind plug ICZ-AIDA1-B to achieve the protection degree IP67. The blind plug ICZ-AIDA1-B is available as an accessory.

See chapter 2.2.4.

Transfer rates, line lengths and line types

The device can be operated in 10 Base-T or 100 Base-TX networks. The maximum total line length is 100 m in both cases and only shielded network cables from category 5 or above can be used.

Refer to the relevant chapter for information on compatible connecting cables.

3.2.3 INTERBUS connection guide

IC-KP-B5-V23:

Round connector: Connector - incoming interface



- 1 DO1
- 2 /DO1
- 3 DI1
- 4 /DI1
- 5 GND
- 6 NC
- 7 NC
- 8 NC
- 9 NC

Round connector: Socket - outgoing interface



- 1 DO2
- 2 /DO2
- 3 DI2
- 4 /DI2
- 5 GND
- 6 NC
- 7 NC
- 8 NC
- 9 /RBST

3.2.4 PROFIBUS connection guide

IC-KP-B6-2V15B:

The data lines RxD/TxD-P and RxD/TxD-N are also referred to as A and B lines. There are no PROFIBUS specifications that indicate which color wire on the data cable should be attached to which terminal. The wire color must be unified within the entire plant. If you use a transfer cable with red and green wires, we recommend the following assignment:

RxD/TxD-N (A line):	green
RxD/TxD-P (B line):	red

The PROFIBUS-DP is connected via a B-encoded M12 socket and a B-encoded M12 connector. The last node on the bus must be terminated using terminator ICZ-TR-V15B on the outgoing socket.

The shield is connected to the IDENTControl via the knurled nut on the connector.



Pin	Connector assignment	Socket assignment
1	NC	VP
2	RxD/TxD-N	RxD/TxD-N
3	NC	DGND
4	RxD/TxD-P	RxD/TxD-P
5	NC	NC

IC-KP-B6-SUBD:

The data lines RxD/TxD-P and RxD/TxD-N are also referred to as A and B lines. There are no PROFIBUS specifications that indicate which color wire on the data cable should be attached to which terminal. The wire color must be unified within the entire plant. If you use a transfer cable with red and green wires, we recommend the following assignment:

RxD/TxD-N (A line):	green
RxD/TxD-P (B line):	red

The PROFIBUS DP is connected via a 9-pin Sub-D socket.

The cable shield must be placed on the thread in the flange of the connecting plug.



1, 2, 4, 7, 9	NC
3	RxD/TxD-P
5	DGND
6	VP
8	RxD/TxD-N

IC-KP-B6-V15B:

The data lines RxD/TxD-P and RxD/TxD-N are also referred to as A and B lines. There are no PROFIBUS specifications that indicate which color wire on the data cable should be attached to which terminal. The wire color must be unified within the entire plant. If you use a transfer cable with red and green wires, we recommend the following assignment:

RxD/TxD-N (A line):	green
RxD/TxD-P (B line):	red

The PROFIBUS DP is connected via a B-encoded M12 socket. This socket is connected to the Y line ICZ-3T-0.2M-PUR ABG-V15B-G so that it can be connected to the bus. Other Y lines can also be connected. Several IDENTControls can be connected directly to the PROFIBUS via several Y lines. The last node on the bus must be connected to the cable from the previous model with a ICZ-2T/TR-0.2M-PUR cable with integrated terminator.

The shield is connected to the IDENTControl via the knurled nut on the connector.



1	VP
2	RxD/TxD-N
3	DGND
4	RxD/TxD-P
5	NC

3.2.5 DeviceNet connection guide

IC-KP-B7-V95:

Network connection

The network connection is established using a DeviceNet MiniStyle connector. The pin assignment is taken from the drawing below.

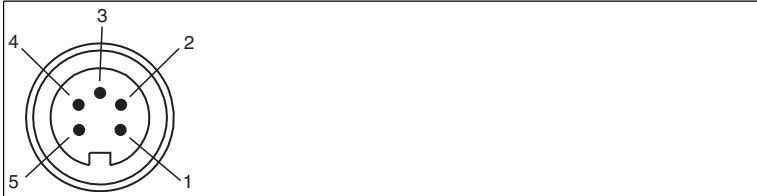

- 1 Ground / uncoated
- 2 V+ / RD
- 3 V- / BK
- 4 CAN_H / WH
- 5 CAN_L / BU

Connecting cable

The device must always be connected using the "Thick" and "Thin" extension cables described in the DeviceNet specification. Refer to the "Thick cable profile" and "Thin cable profile" sections in the DeviceNet specification for more detailed information.

Transfer rates and cable lengths

Baud rate	Max. length of the transfer cable
125 kBits/s	500 m
250 kBits/s	250 m
500 kBits/s	100 m

3.2.6 Command Interface connection guide

IC-KP-R2-V1:

The IDENTControl is fitted with serial interface RS 232.

Select the transfer rate (baud rate) using the software or the display.

The following transfer rates are available:

- 1200, 2400, 4800, 9600, 19200, 38400 bits/s

The status is preset at 9600 Mbit/s on delivery.

The device operates with the following parameters (permanent):

- 8 data bits
- 1 start bit
- 1 stop bit
- No parity

Connect the RS 232 interface via a 4-pin M12 socket. You must place the cable shield on the thread in the connector plug.



Pin assignment of the M12 socket for RS 232

- 1 NC
- 2 RxD
- 3 GND
- 4 TxD

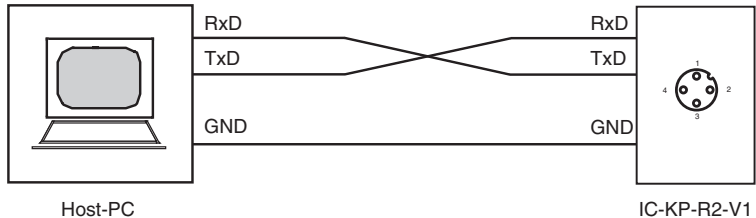

Transfer rates, line lengths and line types

The maximum length of the cable between the control unit and the higher level computer depends on the transfer rate and the noise level. We recommend the following guide value:

Standard	Max cable length
RS232	15 m

3.3 Power supply

Connect the power supply via an M12 connector with integrated voltage and reverse polarity protection indicator (green: correct polarity, red: reverse polarity). A plug with the following pin assignment is located on the housing:



- 1 + 24 V
- 2 NC
- 3 GND
- 4 NC

Power supply AIDA

Connect the power supply for the IDENTControl using a connector that conforms with AIDA. A plug with the following pin assignment is located on the housing:

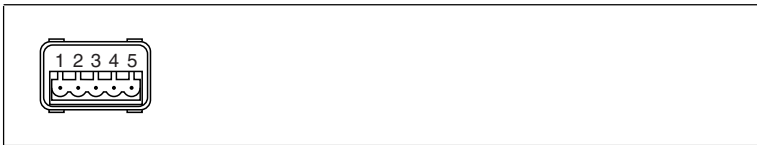

- 1 + 24 V
- 2 GND
- 3 n.c.
- 4 n.c.
- 5 n.c.

Compatible connecting cable see chapter 2.2.2.

3.4 Read/Write Head and Trigger Sensors

A maximum of 4 read/write heads can be connected to the IDENTControl.

Instead of the read/write heads, a maximum of 2 trigger sensors can be connected to sockets 3 and 4. A trigger sensor can be assigned to only one read/write head. The trigger sensors must be PNP.

Connect the read/write heads and trigger sensors to the sockets on the top of the enclosure using M12 connectors.

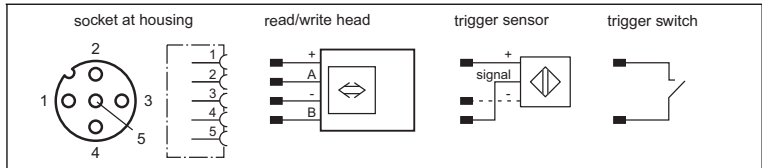

For details of compatible read/write heads and of compatible connecting cables, see chapter 2.2.1.

3.5 Cable length between control interface and R/W heads

The maximum cable length between the control interface and a connected R/W head is 1000 meters. If you wish to attain the maximum possible cable length, select a suitably large cable cross-section. See chapter 2.2.1

3.6 Ground connection

The ground connection of the IDENTControl is located at the lower right of the connector array. The ground conductor is screwed to the housing with a crimp connector. In order to guarantee safe grounding, the serrated washer must be mounted between the crimp connector and the housing.

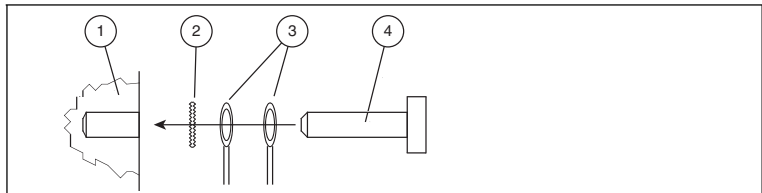

- 1 Housing
- 2 Serrated lock washer
- 3 Crimp connector
- 4 Lock screw

A cross-section of at least 4 mm² is recommended for the ground conductor lead.

4 Commissioning

4.1 Connection

This section contains information on how to commission the IDENTControl.

The example commissioning procedure described relates to the IDENTControl with Ethernet interface.



Caution!

Uncontrolled triggered processes

Before commissioning the device, make sure that all processes are running smoothly; otherwise damage may occur in the plant.



Warning!

Incorrect electrical connection

Damage to the device or plant caused by incorrect electrical connection.

Check all connections in the plant before commissioning the device.

After the supply voltage is connected, the green LED in the voltage connector and the PWR State LED (after a few seconds) on the display panel must light up. If the LED in the connector lights up red, the polarity of the power supply is reversed.

4.2 Setting the IP address

The IP address of the IDENTControl is preset to 169.254.10.12. The way in which the IP address is modified depends on if you are using a DHCP server.

If you are **not using a DHCP server**, the IP address is manually assigned: You preset the IP address using the display and the buttons.

If you are **using a DHCP server (or operating via a PROFINET)**, the server assigns the IP address to the IDENTControl.



Note!

We recommend using a fixed preset IP address in order to avoid system malfunctions.

5 Technical Specifications

5.1 Dimensions

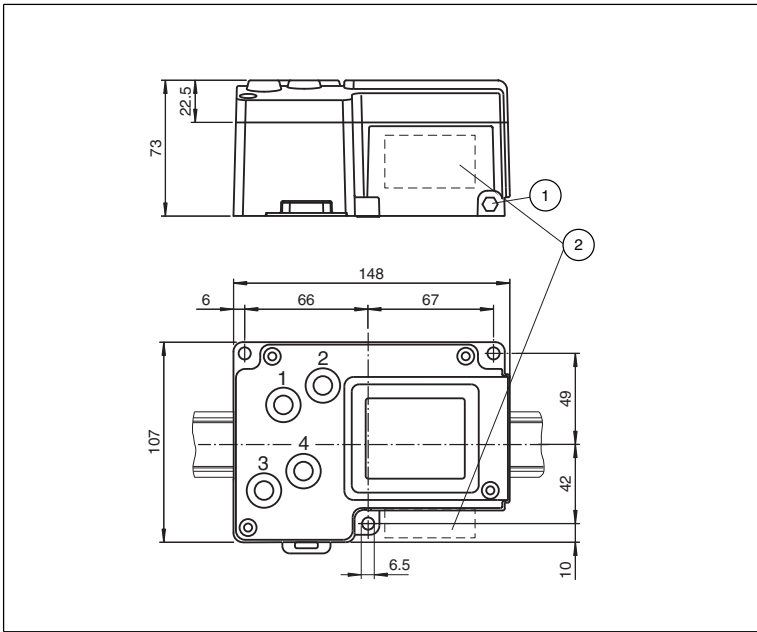

- 1 Ground
- 2 Connector array

FACTORY AUTOMATION – SENSING YOUR NEEDS



Worldwide Headquarters

Pepperl+Fuchs GmbH
68307 Mannheim · Germany
Tel. +49 621 776-0
E-mail: info@de.pepperl-fuchs.com

USA Headquarters

Pepperl+Fuchs Inc.
Twinsburg, Ohio 44087 · USA
Tel. +1 330 4253555
E-mail: sales@us.pepperl-fuchs.com

Asia Pacific Headquarters

Pepperl+Fuchs Pte Ltd.
Company Registration No. 199003130E
Singapore 139942
Tel. +65 67799091
E-mail: sales@sg.pepperl-fuchs.com

www.pepperl-fuchs.com

 **PEPPERL+FUCHS**
SENSING YOUR NEEDS

Subject to modifications
Copyright PEPPERL+FUCHS • Printed in Germany

225149

TDOCT1999C_ENG
10/2013