

MANUAL

**Compact Fieldbus
Power Hub,
Common Interface
Redundant Host Connection**

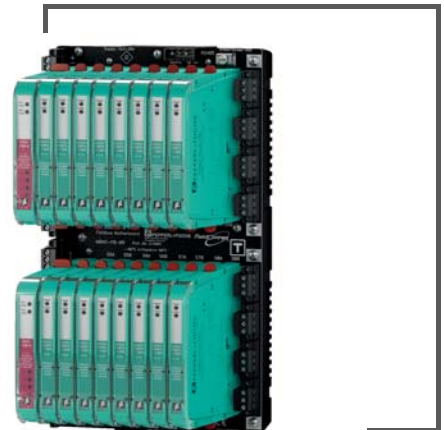

With regard to the supply of products, the current issue of the following document is applicable: The General Terms of Delivery for Products and Services of the Electrical Industry, published by the Central Association of the Electrical Industry (Zentralverband Elektrotechnik und Elektroindustrie (ZVEI) e.V.) in its most recent version as well as the supplementary clause: "Expanded reservation of proprietorship"

1	Safety	5
1.1	Validity.....	5
1.2	Symbols used.....	5
1.3	System Operator and Personnel	5
1.4	Pertinent Laws, Standards, Directives, and further Documentation.....	5
1.5	Delivery, Transport and Storage	6
1.6	Marking	6
1.7	Intended Use	6
1.8	Mounting and Installation.....	7
1.8.1	Mounting Instructions for HD2* Modules.....	7
1.8.2	Zone 2 and Div. 2	7
1.8.3	Ex ic.....	8
1.9	Housing.....	8
1.10	Repair and Maintenance.....	8
1.11	Disposal	8
2	Specification	9
2.1	Overview	9
2.2	System Components	10
2.2.1	Motherboard	10
2.2.2	Power Supply Modules HCD2-FBPS-*	10
2.2.3	Diagnostic Modules	11
2.3	MBHC-FB-8R.RH* Component Identity and Dimensions	12
2.4	MBHC-FB-8R.RH.R* Component Identity and Dimensions.....	13
2.5	Technical Data	13

3	Installation and Commissioning	16
3.1	Mounting and Dismounting	16
3.2	Mounting the Grounding Rail (ACC-MB-HSK)	17
3.3	Shielding and Grounding	18
3.4	Connection Layout	19
3.5	Installation Requirements for Ex ic Installations.....	21
3.6	Segment Termination	21
4	Thermal Dissipation	22
5	Appendix	24
5.1	MBHC-FB-8R.RH* Installation Drawing	24
5.2	MBHC-FB-8R.RH.R* Installation Drawing.....	25
5.3	Ordering Information.....	26
5.4	Electromagnetic Compatibility Verification in Accordance with EC Council Legislation Directive 2004/108/EC.....	26
5.5	Referenced Documents	27

1 Safety

1.1 Validity

Specific processes and instructions in this document require special precautions to guarantee the safety of the operating personnel.

1.2 Symbols used

This document contains information that you must read for your own personal safety and to avoid property damage. Depending on the hazard category, the warning signs are displayed in descending order as follows:

Safety-relevant symbols



Danger!

This symbol indicates an imminent danger.

Non-observance will result in personal injury or death.



Warning!

This symbol indicates a possible fault or danger.

Non-observance may cause personal injury or serious property damage.



Caution!

This symbol indicates a possible fault.

Non-observance could interrupt devices and any connected systems and plants, or result in their complete failure.

Informative symbols



Note!

This symbol brings important information to your attention.



Action

This symbol indicates a paragraph with instructions.

1.3 System Operator and Personnel

Responsibility for planning, assembly, commissioning, operation, maintenance, and dismounting lies with the plant operator.

Mounting, installation, commissioning, operation, maintenance and disassembly of any devices may only be carried out by trained, qualified personnel. The instruction manual must be read and understood.

1.4 Pertinent Laws, Standards, Directives, and further Documentation

Laws, standards, or directives applicable to the intended use must be observed. In relation to hazardous areas, Directive 1999/92/EC must be observed.

The corresponding datasheets, declarations of conformity, EC-type-examination certificates, certificates and Control Drawings if applicable (see datasheet) are an integral part of this document. You can find this information under www.pepperl-fuchs.com.

Due to constant revisions, documentation is subject to permanent change. Please refer only to the most up-to-date version, which can be found under www.pepperl-fuchs.com.

1.5 Delivery, Transport and Storage

Check the packaging and contents for damage.

Check if you have received every item and if the items received are the ones you ordered.

Keep the original packaging. Always store and transport the device in the original packaging.

Always store the device in a clean and dry environment. The permitted storage temperature (see data sheet) must be considered.

1.6 Marking

Motherboards

MBHC-FB-8R*

Pepperl+Fuchs GmbH

Fieldbus Power Hub
Motherboard

TÜV 10 ATEX 555761X

 II 3G Ex nA IIC T4 Gc

IECEX TUN 13.0037X

Ex nA IIC T4 Gc

Fieldbus Power Hubs

HCD2-FBPS-1.500

Pepperl+Fuchs GmbH

Fieldbus Power Hub
Galvanically Isolated Fieldbus Power Supply

TÜV 10 ATEX 555761X

 II 3G Ex nA IIC T4 Gc

IECEX TUN 13.0037X

Ex nA IIC T4 Gc

HCD2-FBPS-1.23.500

Pepperl+Fuchs GmbH

Fieldbus Power Hub
Galvanically Isolated Fieldbus Power Supply

TÜV 10 ATEX 555761X

 II 3G Ex nA IIC T4 Gc

IECEX TUN 13.0037X

Ex nA IIC T4 Gc

Diagnostic Modules

For marking information of the diagnostic modules refer to the instructions or manuals of the respective diagnostic module used.

1.7 Intended Use

The FieldConnex[®] compact Power Hub is intended to power 8 FOUNDATION Fieldbus H1 segments in redundant mode according to IEC 61158-2.

The compact Power Hub may be installed in Zone 2 or Class I, Division 2 hazardous areas. Types of protection are Ex nA (non-sparking) for Zone 2, gas groups IIC, IIB, IIA, and non-incendive for use in Class I, Division 2, gas groups A, B, C, and D.

Dedicated power supply modules limit the output voltage safely according to IEC 60079-11. In combination with Pepperl+Fuchs Segment Protectors, the outputs are specified Ex ic. Thus, live maintenance at the field device level is permitted.

For further information about hazardous area installation refer to referenced documents see chapter 5.5.

The device is only approved for appropriate and intended use. Ignoring these instructions will void any warranty and absolve the manufacturer from any liability.

The device must only be operated in the ambient temperature range and at the relative humidity (non-condensing) specified.

1.8 Mounting and Installation

Prior to mounting, installation, and commissioning of the device you should make yourself familiar with the device and carefully read the instruction manual.

Trunk and spur connectors are only allowed to be manipulated at ambient temperatures between -5 °C and +70 °C.

The device may be installed in a corrosive location acc. to ISA-S71.04-1985, severity level G3.

1.8.1 Mounting Instructions for HD2* Modules

The modules are intended for mounting on an appropriate fieldbus Power Hub motherboard.

The Power Hub motherboard features a special connection slot for HD2-DM-* diagnostic modules labeled "Diagnostic Module only". Do not try to plug any other modules into this connection slot. Other modules may be damaged.

Instruction for Redundant Systems

Each segment on a redundant motherboard must only be fitted with 2 power modules of the same type.

1.8.2 Zone 2 and Div. 2

Connection or disconnection of energized non-intrinsically safe circuits is only permitted in the absence of a hazardous atmosphere.

It is necessary to pay particular attention to the type of fieldbus power supply selected for use on the Power Hub. This determines the type of Zone 2/Div. 2 installations and certified field instruments that can be connected in Zone 2 or Div. 2 area.

Take special care when using power supply modules with Pepperl+Fuchs Segment Protectors for intrinsically safe Ex ic and non-incendive field wiring. Double-check to ensure that the correct type of power supply module is used in relation to its output values. For example, the output voltage must be equal or less than the maximum voltage of the connected field devices.

Requirements for all used fieldbus products in Zone 2 installations are summarized in the manual: "Using Pepperl+Fuchs fieldbus equipment in Zone 2 hazardous area environment". You will find this document on the product page of the device at www.pepperl-fuchs.com.

The device must be installed and operated only in surrounding enclosures that

- comply with the requirements for surrounding enclosures according to IEC/EN 60079-0,
- are rated with the degree of protection IP54 according to IEC/EN 60529.

Prevent any electrostatic charge that could result in electrostatic discharge while installing or operating the device.

In Zone 2, only such device is allowed to be connected to circuits that is suitable for the operation in hazardous areas of Zone 2 and for the conditions available at the place of operation (declaration of conformity or certificate of a testing department).

1.8.3 Ex ic

The intrinsically safe circuits of the associated apparatus may lead into hazardous areas. Make sure to observe all relevant distances (creepage distances, clearances) to all non-intrinsically safe circuits in accordance with IEC/EN 60079-14.

If "Ex ic" protected circuits are operated with non-intrinsically safe circuits, they must no longer be used as "Ex ic" protected circuits.

The respective peak values of the field device and the associated apparatus with regard to explosion protection should be considered when connecting intrinsically safe field devices with intrinsically safe circuits of associated apparatus (verification of intrinsic safety). Make sure to observe IEC/EN 60079-14 and IEC/EN 60079-25.

When using the Fieldbus Power Hub with Pepperl+Fuchs Segment Protectors to generate Ex ic rated outputs, connector covers (ACC-MB-CC) have to be plugged on the bulk power supply connectors. This is to guarantee the clearance distance of 50 mm between host terminal and power supply connectors.

The device must be installed and operated only in an environment that ensures a pollution degree 2 (or better) according to IEC/EN 60664-1.

1.9 Housing

If additional housings are needed for installation in hazardous areas, the following points must be considered / evaluated:

To ensure the degree of protection:

- All seals must be undamaged and correctly fitted.
- All screws of the housing/housing cover must be tightened with the appropriate torque.
- Only cable of the appropriate size must be used in the cable glands.
- All cable glands must be tightened with the appropriate torque.
- All unused cable glands must be sealed or plugged with corresponding stopping plugs

1.10 Repair and Maintenance

The devices must not be repaired, changed or manipulated. If there is a defect, the product must always be replaced with an original device.

1.11 Disposal

Disposing of device, packaging material, and possibly contained batteries must be in compliance with the applicable laws and guidelines of the respective country.

2 Specification

2.1 Overview

The FieldConnex[®] compact Power Hub is intended to power 8 FOUNDATION Fieldbus H1 segments in redundant mode according to IEC 61158-2.

The compact Power Hub is a high-performance power supply for FOUNDATION Fieldbus H1, consisting of a motherboard with sockets for plug-in modules. In redundant versions, the Power Hub features 2 power supply modules per segment. For each 4 segments, a socket for 1 diagnostic module is available.

The Power Hub is designed for use with fieldbus systems in accordance with IEC 61158-2. This standard specifies how power and communication are transmitted sharing a shielded twisted pair cable. Communication between field devices and a host system is established by modulating the data signal onto the power stream. For this, Manchester Bus Powered (MBP) transmission technology is used.

All FieldConnex[®] compact Power Hubs feature superior design elements. The main design features are passive impedance generation, well-balanced circuitry, and low power dissipation. All active electronic components are located in the plug-in modules. Each module holds the electronic components for 1 segment and 2 modules operate in redundant configuration. When an exchange becomes necessary, only few electronic components need to be exchanged when compared to block configurations for power supplies. Modules can be exchanged while the system is energized without tools, thus ensuring high system availability.

Impedance generation prevents the data signal from being short-circuited by the low internal resistance of the power supply. This impedance generation is designed with passive components such as inductances and resistors with long durability.

A fully balanced circuit and segment design is important for undisturbed fieldbus operation. An external disturbance through EMI impacts both leads of the shielded twisted pair cable symmetrically. The data signal is thus undisturbed. Low power dissipation allows highest packing density inside the cabinet and a long service life.

When applied to fieldbus in hazardous areas, the Power Hub feeds segments following the high-power trunk concept for explosion protection. High power level on the trunk line is fed to the field device via couplers such as FieldBarriers or Segment Protectors. The Power Hub powers segments installed as non-sparking (Ex nA).

FieldBarriers enable live maintenance in Zone 0/1 as outputs are classified Ex ia. Thus, power limitations of intrinsically safe explosion protection are overcome, enabling maximum cable lengths and highest number of devices in any hazardous area.

2 plug-in advanced diagnostic modules for fieldbus are available. These modules monitor the physical layer online and in real time, enabling detection of degradation and faults during operation. Measurement data and alarms are transmitted to the control room. They bring visibility to the fieldbus physical layer, so it can be treated as an active component in plant asset management systems. On this basis, operators can decide on proactive measures to avoid unwanted situations while the plant is running smoothly.

The following table summarizes the main features and benefits of the Power Hub:

Features	User benefit
Lowest heat dissipation of less than 2 W per segment under full load condition.	Long service life. Very high packing density and reduced cooling requirements.
Exchange of modules while the system is energized and load share between power modules.	Increased segment availability.
Full balance of electric circuitry with high isolation against RF and in-band interference.	High resistance to external disturbance such as EMI.
High-integrity passive power conditioners.	Long service life.

Features	User benefit
Local and remote alarm annunciation.	Easy maintenance and troubleshooting.
Tolerance against inrush currents during segment start.	Long-term, robust operation with tolerance towards field device misbehavior.
Full current span operation from 10...500 mA.	Flexible segment design and tolerance against live working on field devices.
Advanced diagnostic module for physical layer fieldbus diagnostics.	Improved and known quality of fieldbus installation. Live supervision for preventive and pro-active maintenance. Professional tools for easy fieldbus troubleshooting.

2.2 System Components

FieldConnex® Power Hubs consist of several system components, e.g., the Motherboard, the Power Supply Modules, and diagnostic modules. The following sections offer detailed information on these components.

2.2.1 Motherboard

MBHC-FB-8R.RH*

The motherboard MBHC-FB-8R.RH* allows the redundant supply of 8 segments and the redundant connection of the FOUNDATION Fieldbus H1 Host system aligned on the left side of the motherboard. The 16 sockets hold the power supply modules with 2 each redundantly supplying 1 of the 8 segments. 2 extra sockets hold diagnostic modules.

MBHC-FB-8R.RH.R*

The motherboard MBHC-FB-8R.RH.R allows the redundant supply of 8 segments and the redundant connection of the FOUNDATION Fieldbus H1 host system aligned on the right side of the motherboard. The 16 sockets hold the power supply modules with 2 each redundantly supplying 1 of the 8 segments. 2 extra sockets hold diagnostic modules.



Note!

If the motherboard is intended to be used with dedicated power supply modules and Segment Protectors to generate Ex ic rated outputs, a connector cover has to be mounted on each power supply terminal. 2 connector covers and special connectors come with each motherboard.

2.2.2 Power Supply Modules HCD2-FBPS-*

Power supply modules provide full galvanic isolation between the bulk power supply and the segments. They provide optimum system reliability for applications where cabling and wiring are routed through critical or harsh electrical environments. Power supply modules are the best choice in situations, where full protection from electromagnetic interference (EMI) is mandatory.

Power modules are connected to the motherboard via sockets. They can be exchanged while the system is in operation. In redundant configuration, load is shared between 2 power modules.

For different application requirements, special power supply modules are available:

Designation	Application
HCD2-FBPS-1.500	Ex ic
HCD2-FBPS-1.23.500	Ex ic

2.2.3 Diagnostic Modules

Basic Diagnostic Module

The basic diagnostic module provides basic system diagnostics. It monitors the input voltage of the bulk power supply and each segment for overload and short circuit conditions. Each power supply module is checked for proper function. Power modules operating in redundant configuration are checked for compatibility. LEDs indicate both status and fault information. This information can be transmitted via volt-free contact.

For further information refer to the instructions "Basic Diagnostic Module HD2-DM-B".

Advanced Diagnostic Module

The advanced diagnostic module is a comprehensive measurement tool for the fieldbus physical layer. It is well suited for commissioning, online monitoring and maintenance. The module provides the exact segment and individual device data needed for detection of changes in the fieldbus physical layer. Segment measurements include fieldbus voltage and load current; device-specific measurements are: signal level, noise, and jitter. All data is transmitted to the control room via Ethernet. The Diagnostic Manager – Basic Edition shows all data on easy-to-use displays.

The Diagnostic Manager – Professional Edition offers extra functionality: the commissioning wizard generates automated reports; the software displays clear text messages for troubleshooting of out-of-specification behavior. The OPC server transmits user-selectable common alarms to the process control system.

For further information refer to the manual "Advanced Diagnostic Module HD2-DM-A".

Advanced Diagnostic Module Relay Contact Output

The advanced diagnostic module relay contact output is a tool for permanently monitoring the fieldbus physical layer. Using DIP switches, limit ranges can be configured for each physical layer parameter monitored.

The module distinguishes between 2 alarm types:

- Maintenance required alarm
- Out of specification alarm

The "Maintenance required" alarm enables proactive diagnostics. If a value exceeds the limit, a relay contact opens and the respective segment LED starts to flash yellow. With this proactive diagnostics, changes within the fieldbus installation can be detected early and fault sources can be found before communication fails.

If an "Out of specification" alarm occurs (LED flashing red) that means: One of the monitored physical layer parameters has rapidly declined and moved out of range of "Maintenance required". A fast examination of the affected segment is crucial to prevent a total dropout of this segment in the near future.

In order to set the appropriate limit values for your fieldbus installation during commissioning, a comprehensive diagnostic solution is required. For DIP switch configuration, you can use the mobile advanced diagnostic module.

For further information refer to the manual "Advanced Diagnostic Module HD2-DM-A.RO".

2.3

MBHC-FB-8R.RH* Component Identity and Dimensions

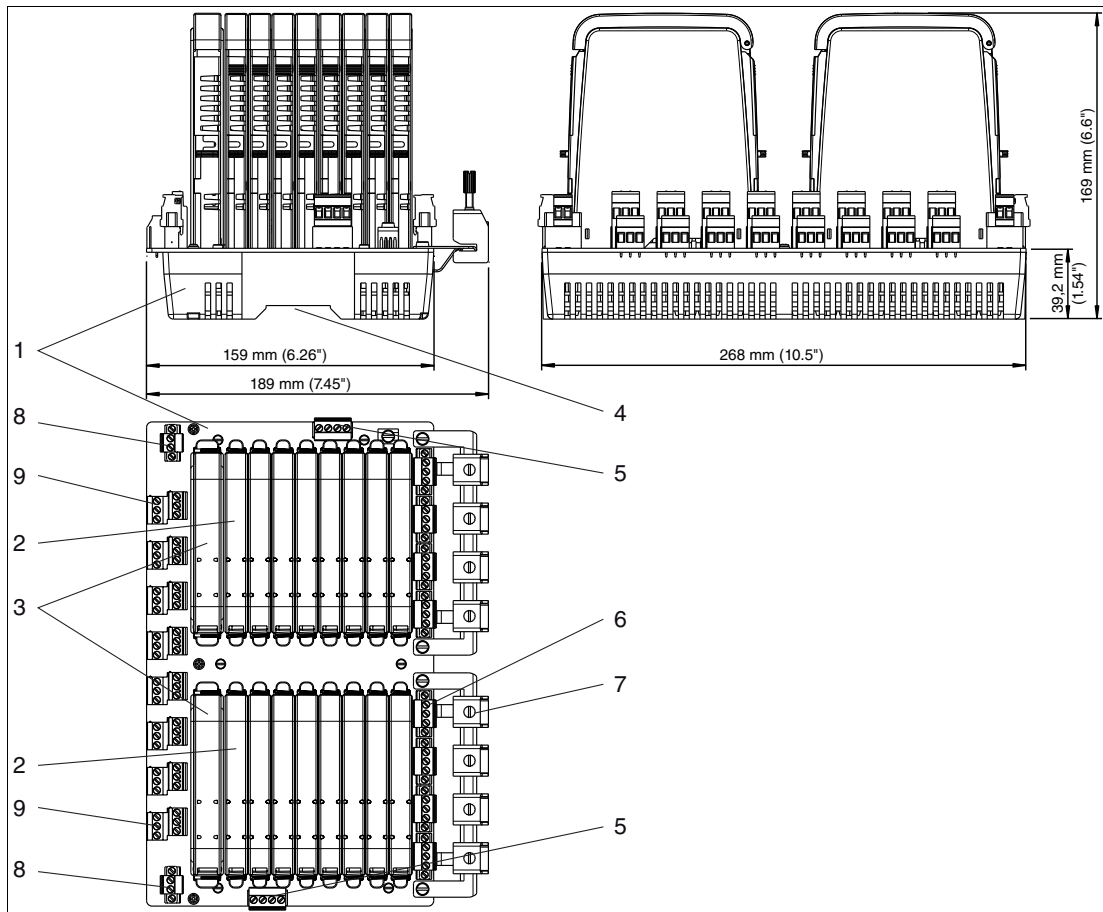

- 1 Motherboard MBHC-FB-8R.RH*
- 2 Power supply modules
- 3 Diagnostic modules
- 4 Mounting slot for DIN rail
- 5 Connections for alarm voltage-free contact and diagnostic bus (diagnostic link cable, ACC-MB-HDC, optional accessory)
- 6 Connections for fieldbus trunk
- 7 Screening/earthing kit for trunk cables shield (ACC-MB-HSK, optional accessory)
- 8 Connections for bulk power supply
- 9 Connections for host

2.4 MBHC-FB-8R.RH.R* Component Identity and Dimensions

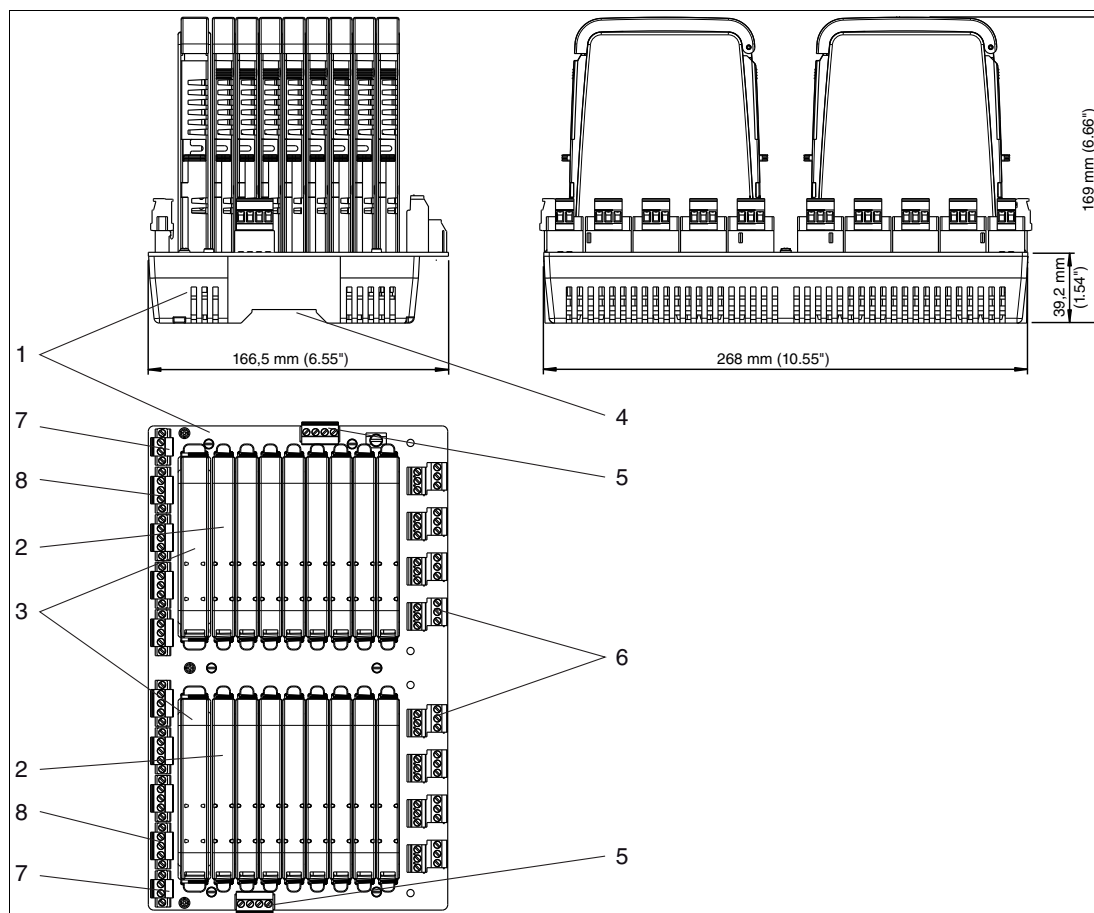

- 1 Motherboard MBHC-FB-8R.RH.R*
- 2 Power supply modules
- 3 Diagnostic modules
- 4 Mounting slot for DIN rail
- 5 Connections for alarm voltage-free contact and diagnostic bus (diagnostic link cable, ACC-MB-HDC, optional accessory)
- 6 Connections for host
- 7 Connections for bulk power supply
- 8 Connections for fieldbus trunk

2.5 Technical Data

System Specification

Ambient conditions	
Ambient temperature	-40 ... 70 °C (-40 ... 158 °F)
Storage temperature	-40 ... 85 °C (-40 ... 185 °F)
Relative humidity	< 95 % non-condensing
Shock resistance	15 g 11 ms
Vibration resistance	1 g , 10 ... 150 Hz
Pollution Degree	max. 2, according to IEC 60664
Corrosion resistance	acc. to ISA-S71.04-1985, severity level G3

Mechanical specifications	
Connection type	plug-in terminals , screw terminal
Core cross-section	2.5 mm ²
Degree of protection	IP20
Directive conformity	
Electromagnetic compatibility	
Directive 2004/108/EC	EN 61326-1:2013
Standard conformity	
Electromagnetic compatibility	NE 21:2011
Degree of protection	IEC 60529
Fieldbus standard	IEC 61158-2
Shock resistance	EN 60068-2-27
Vibration resistance	EN 60068-2-6

Motherboard Types MBHC-FB-8R*.RH*

Supply	
Connection	redundant
Rated voltage	19.2 ... 35 V SELV/PELV
Rated current	16 A
Power loss	typ. 0.4 W per segment
Terminating resistor	100 Ω integrated
Indicators/operating means	
Fault signal	VFC alarm 1 A, 50 V DC, normally closed

Isolated Power Supply Module Type HCD2-FBPS-1.500

Supply	
Rated voltage	19.2 ... 35 V DC
Power loss	typ. 1.6 W
Fieldbus interface	
Rated voltage	28 ... 30 V
Rated current	500 ... 10 mA
Short-circuit current	550 mA
Indicators/operating means	
LED ERR	red flashing: short-circuit or undervoltage at output
LED PWR	green if $U_{out} > 28 V$
Data for application in connection with Ex-areas	
Outputs	
Voltage	30 V

Isolated Power Supply Module Type HCD2-FBPS-1.23.500

Supply	
Rated voltage	19.2 ... 35 V DC
Power loss	typ. 1.6 W
Fieldbus interface	

2014-10

Rated voltage	21 ... 23 V
Rated current	500 ... 10 mA
Short-circuit current	550 mA
Indicators/operating means	
LED ERR	red flashing: short-circuit or undervoltage at output
LED PWR	green if $U_{out} > 21$ V
Data for application in connection with Ex-areas	
Outputs	
Voltage	24 V

For information on the technical data of the respective diagnostic modules, refer to the respective data sheets, manuals or instructions of the diagnostic module used.

3 Installation and Commissioning

3.1 Mounting and Dismounting



Mounting of Fieldbus Motherboards on DIN Mounting Rail

In order to mount a motherboard on a DIN mounting rail, proceed as follows:

1. Place the motherboard on the DIN mounting rail.
2. Tighten the two fastening screws to attach the motherboard on the DIN mounting rail.

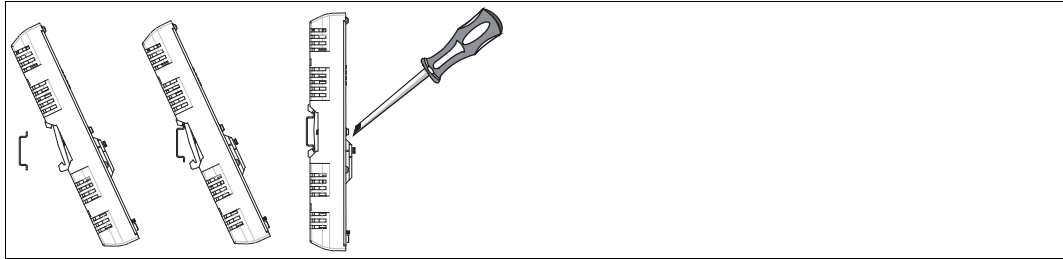

↳ The motherboard has been mounted.



Mounting Modules on the Motherboard



Caution!

Hardware Damage

The Power Hub motherboard includes a dedicated connection slot for the HD2-DM* diagnostic modules labeled "Diagnostic Module only".

Do not try to plug other modules into this connection slot. Other modules may be damaged.

To install a new module on the motherboard, proceed as follows:

1. Carefully center the polarization holes and mate the 2 connectors, then gently press down the module.
2. Push down the red Quick Lok bars on each side of the module to fix it to the panel. No tools required.

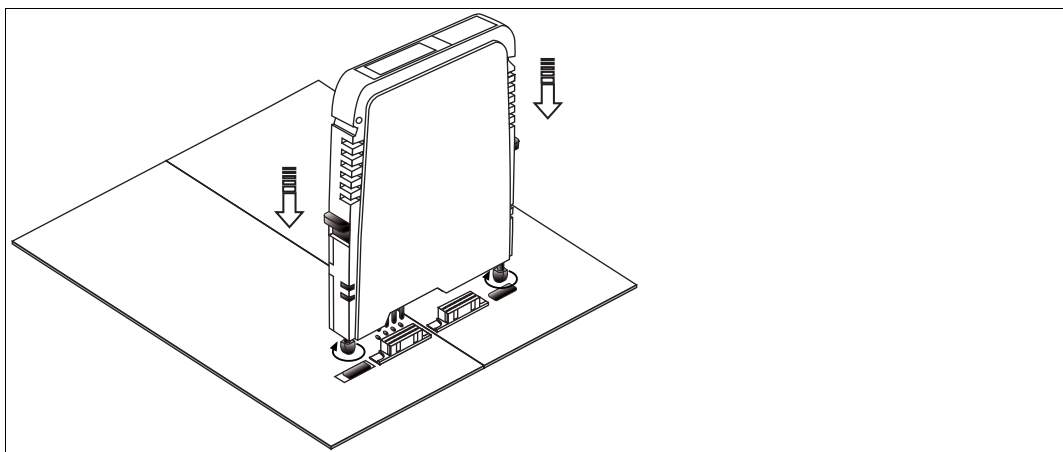

↳ The new module has been installed.



Dismounting Modules from the Motherboard

To dismount a module from the motherboard, proceed as follows:

Pull up the red Quick Lok Bars on each side of the module and carefully lift off the entire module.

↳ The module has been removed from the motherboard.

3.2 Mounting the Grounding Rail (ACC-MB-HSK)

Easy Shield Connection

If required, you can attach a grounding rail to the motherboard in order to connect the shield at the trunk cable more easily. The grounding rail is available as accessory ACC-MB-HSK.

Mounting the Grounding Rail (ACC-MB-HSK)

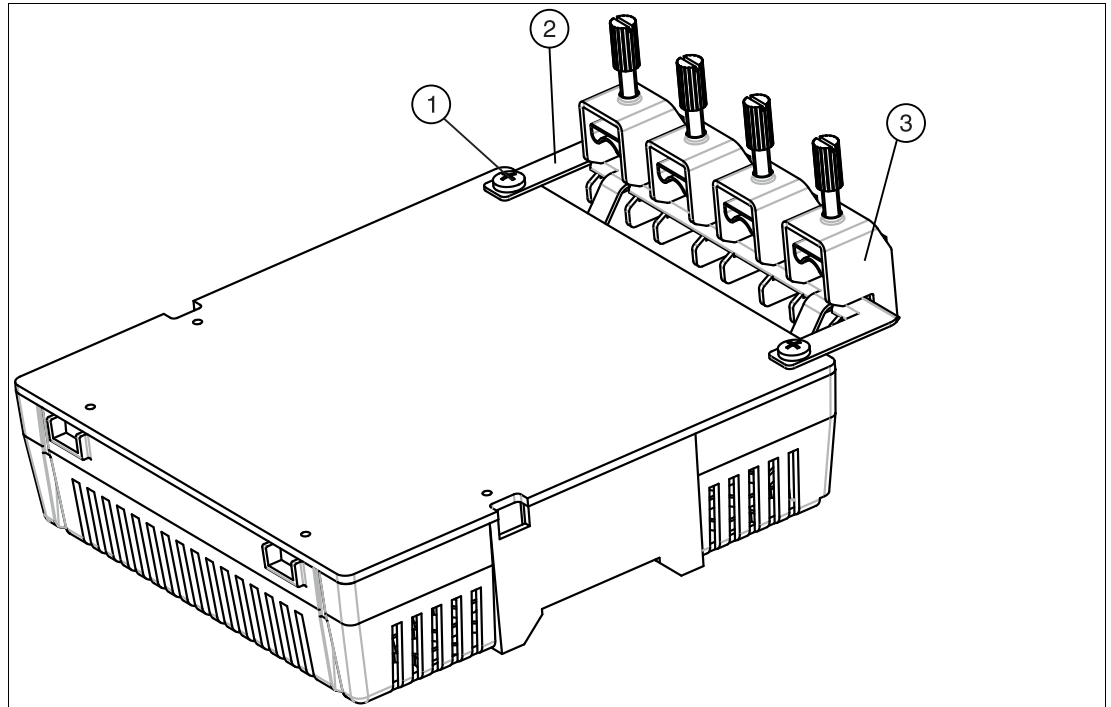

- 1 Connection screws DIN 7985 M4 x 10 (2x): Use to fix the grounding rail to the mother-board
- 2 Grounding rail
- 3 Shield clamps (4x): Use to connect the shield lines with the grounding rail

3.3 Shielding and Grounding

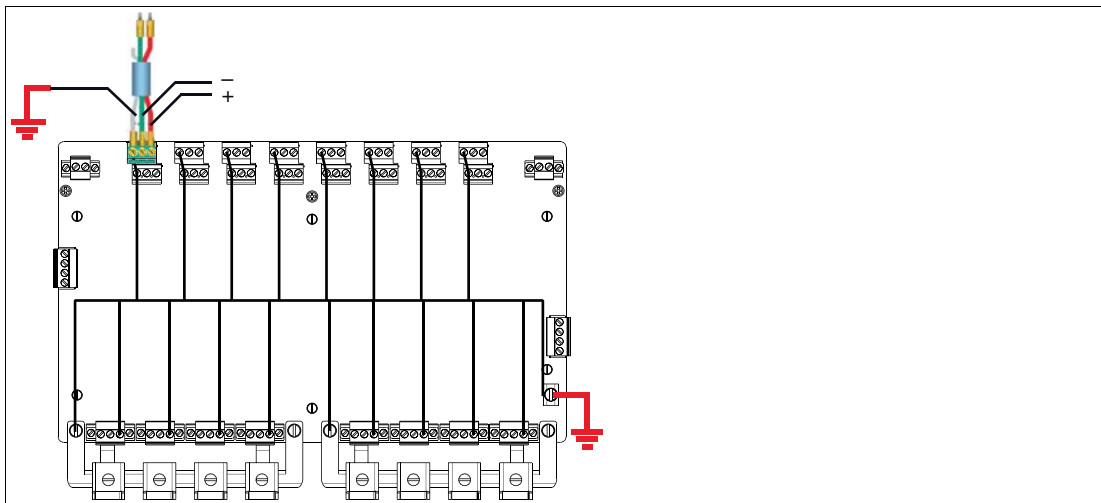

Figure 3.1 MBHC-FB-8R.RH

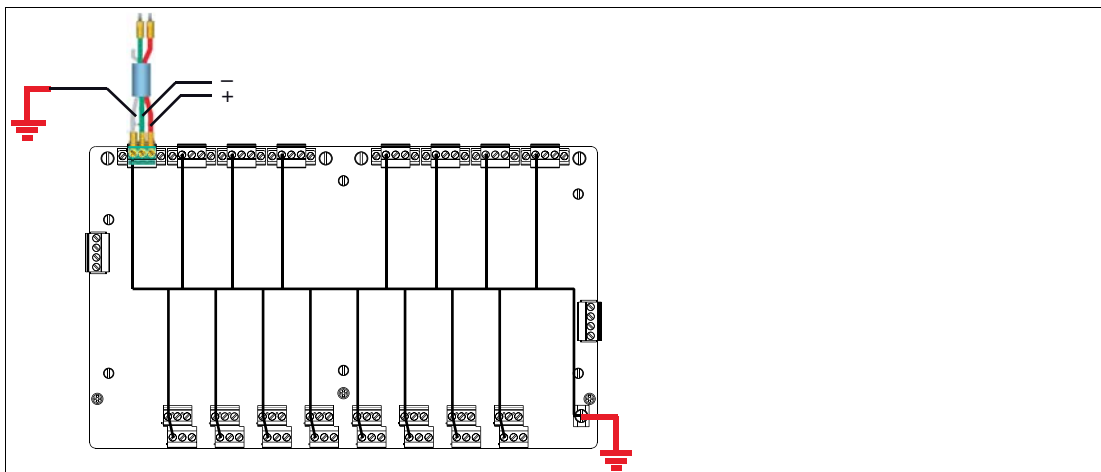

Figure 3.2 MBHC-FB-8R.RH.R

Prevent Grounding Loops

Depending on the chosen grounding method, the shield ground at the host connection can be left open.

In order to prevent a grounding loop if the grounding points of the host and the field devices do not have the same potential: Leave the shield of the motherboard open.



Caution!

Risk of electric shock and property damage through inadequate grounding

If you fail to connect all metal parts of the device to protective local earth correctly, this could result in potential equalization currents. These currents could hurt operating personnel or cause property damage.

The grounding terminal is not a safety earth: Do not use the grounding terminal to ground exposed metal parts.

Ground exposed metal parts of the device separately. Ensure that a correct grounding is guaranteed at all times.

3.4 Connection Layout

The following section describes the different connection details of the motherboard with particular reference to the torques required for a safe installation.

For any terminal connections, observe the following cable and connection information.

Screw Terminals: Cable and Connection Information

- Permissible wire core section:
 - Screw terminals with flexible or rigid wires: 0.2-2.5 mm²
- Insulation stripping length: 7 mm
- If you use stranded connectors: Crimp on wire end ferrules
- Ensure that connectors are mechanically locked
- Torque required for tightening terminal screws: 0.4-0.5 Nm



Tip

Double-check that the correct torques are used when un- and reinstalling the terminal during wiring activities!

Connecting the Trunk

The motherboard is connected to the trunk line via designated screw terminals. .

Trunk Connection with Screw Terminal

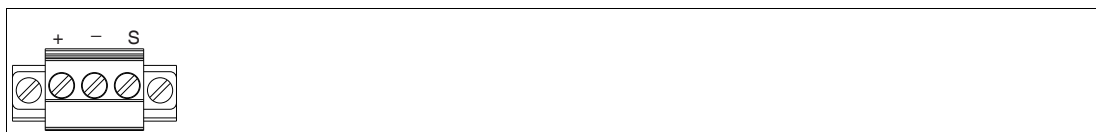

- +** Segment +
- Segment -
- S** Shield connection

Connecting the DCS/PLS

The motherboard is redundantly connected to the host system via double-level terminal blocks. .



- +** Host +
- Host -
- S** Shield



Note!

The circuits on the two levels are connected with each other via the motherboard.

Connecting the Diagnostic Bus

The motherboard is connected to the diagnostic bus via plug-in terminals on fixed circuit board connectors. .

Diagnostic Bus Connection with Screw Terminal

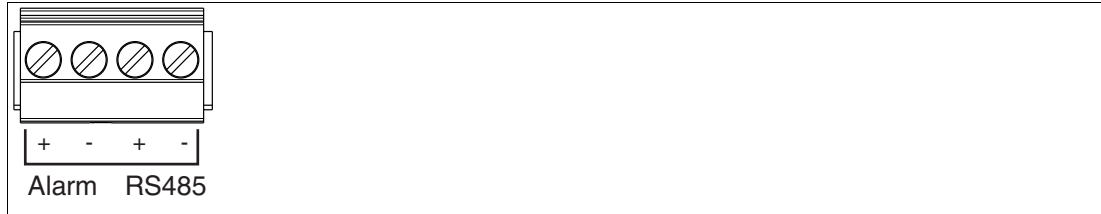

Alarm	Alarm signal lines
+	Diagnostic bus +
-	Diagnostic bus -

Connecting the Power Supply

The motherboard is connected to the bulk power supply via designated screw terminals. .

Power Supply with Screw Terminal



+	PWR
-	PWR

Grounding

The motherboard is connected to the earth via designated screws.

If needed, an optional grounding rail can be applied.

The torque required for tightening the grounding screws: 1.5 Nm

3.5 Installation Requirements for Ex ic Installations

If the fieldbus power hub is used in an intrinsically safe installation (Ex ic), ensure that the following installation requirements are fulfilled:



Mounting the Connector Cover ACC-MB-CC for Ex ic Installations



Warning!

Risk of explosion through wrong wiring practice!

Wrong wiring practice violates the targeted explosion protection and causes risk of explosion.

- Use the delivered connector without fastening screws only in combination with the connector cover.
- Use the delivered connector without fastening screws only on primary and secondary bulk power terminals.

1. Slide the connector cover over the stripped power supply cable.



2. Screw the leads into the delivered connector.



3. Mount the connector onto the power terminal.

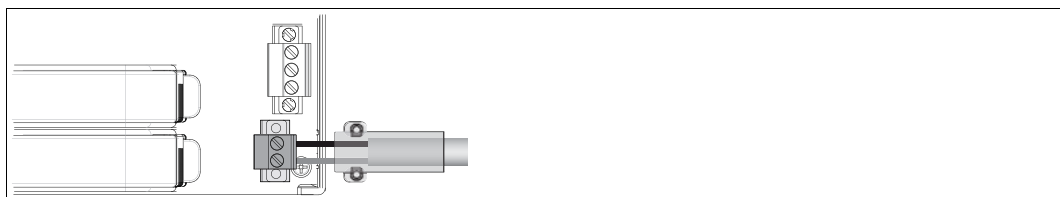

4. Put the connector cover over the power supply connector and tighten the fastening screws.

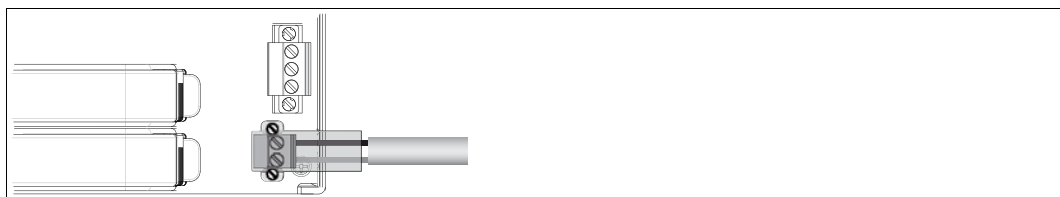

3.6 Segment Termination

Motherboards have integrated terminators for each segment.



Caution!

Communication Problems

Wrong termination may cause communication problems or a total communication loss.

- Make sure that two terminators are activated on each trunk line.
- Verify that a terminator is located at each end of the trunk line.

4 Thermal Dissipation

Each power supply dissipates, i.e., loses energy in form of heat. The graphs below illustrate typical power dissipation values in watt (W) for one segment for given output currents and supply voltages. These include the power dissipation of the motherboard.

Thermal Dissipation of HCD2-FBPS-1.500 Including Motherboard

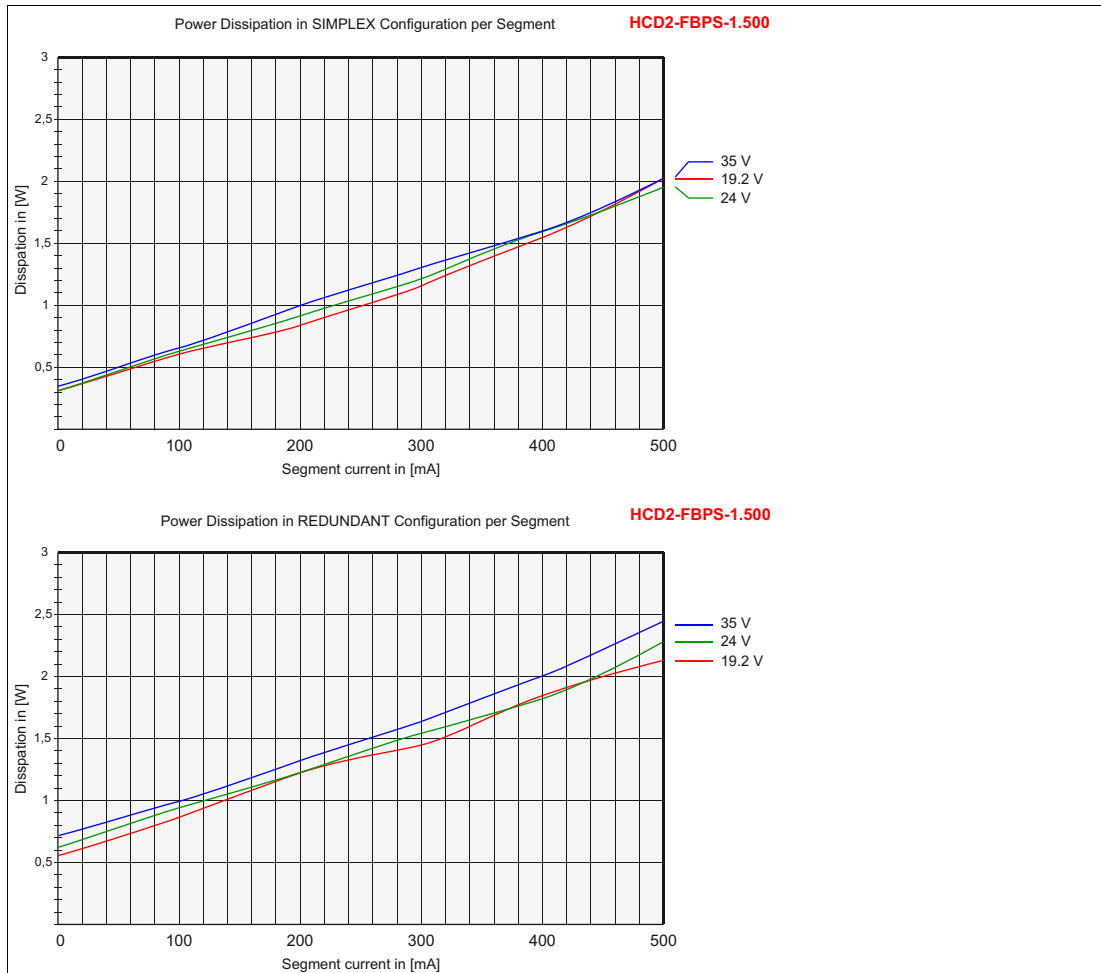

Thermal Dissipation of HCD2-FBPS-1.23.500, Including Motherboard

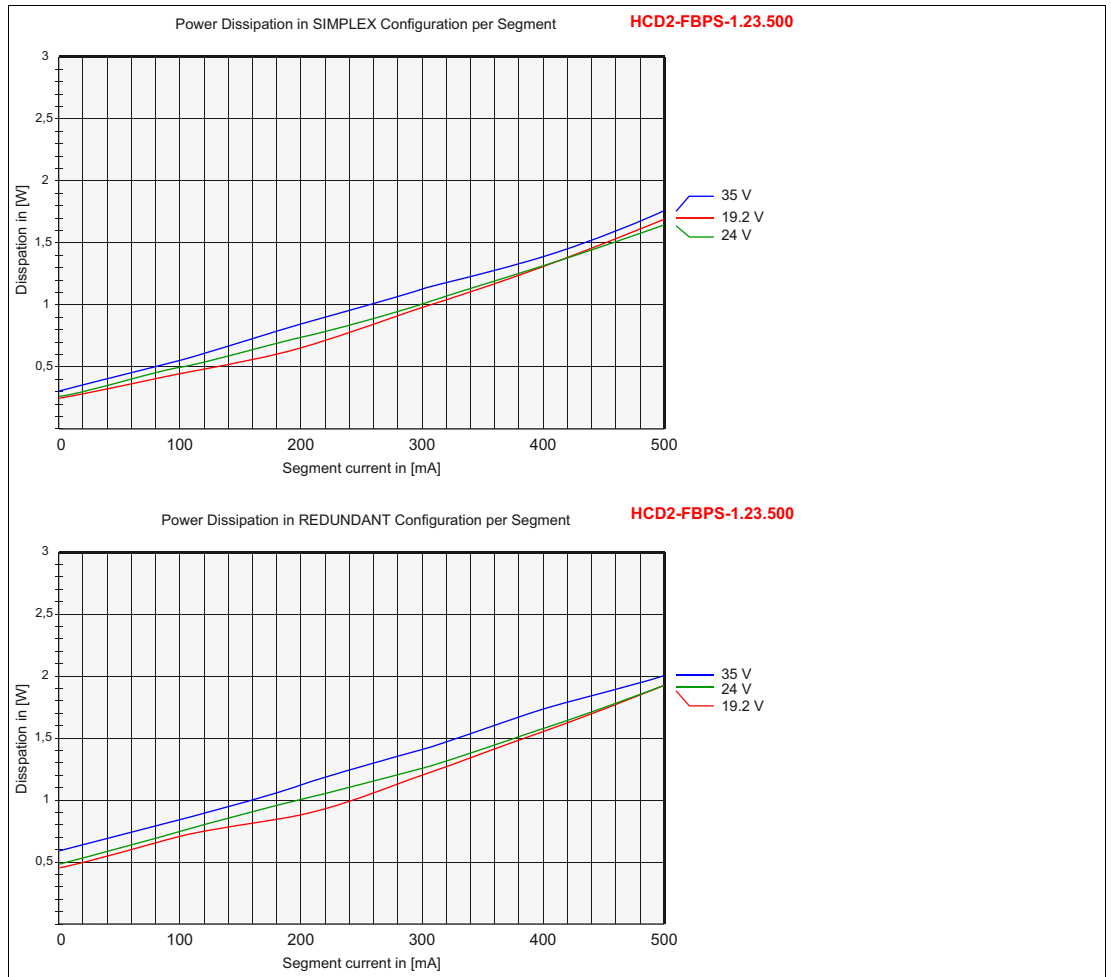

5 Appendix
5.1 MBHC-FB-8R.RH* Installation Drawing

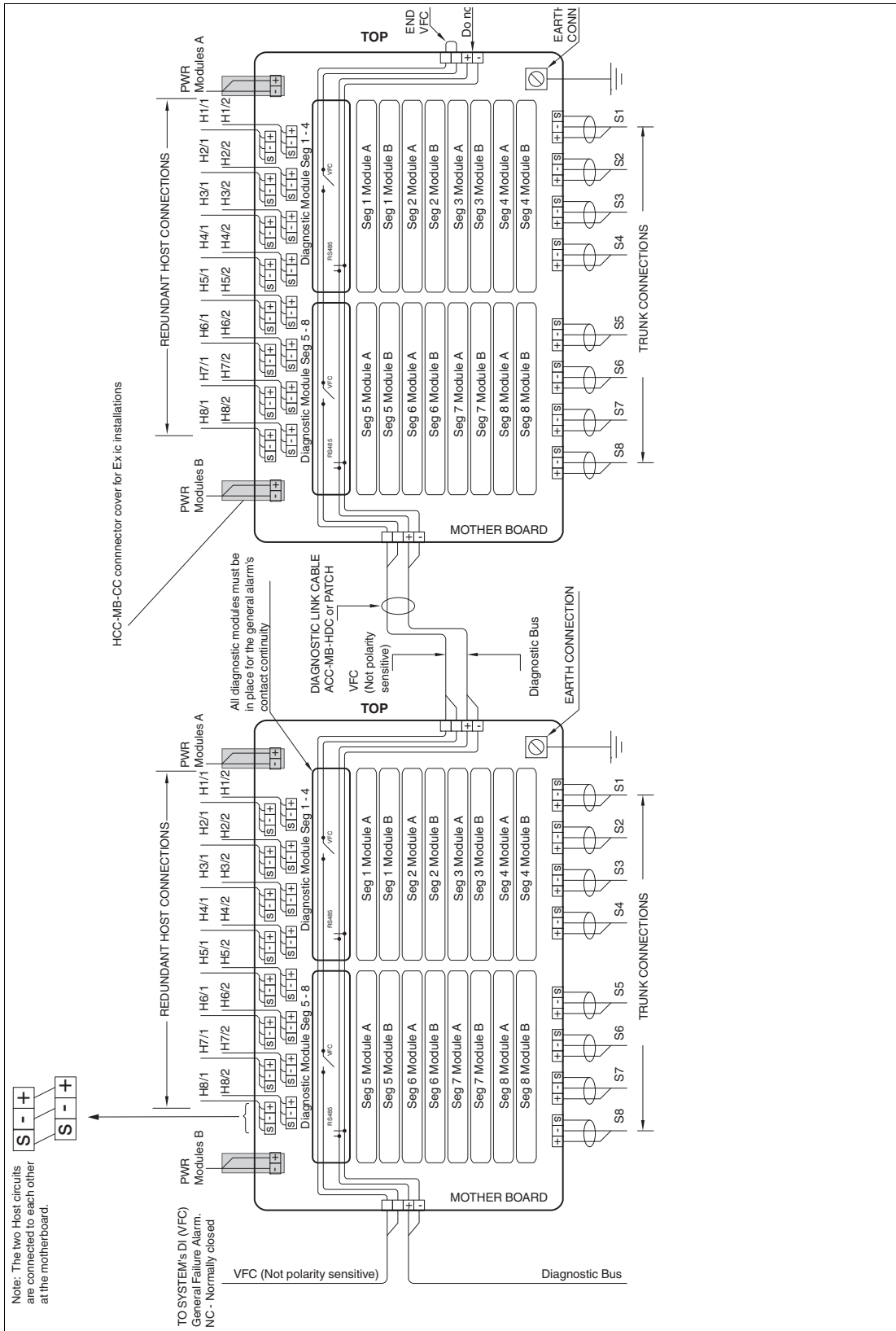

2014-10

5.2 MBHC-FB-8R.RH.R* Installation Drawing

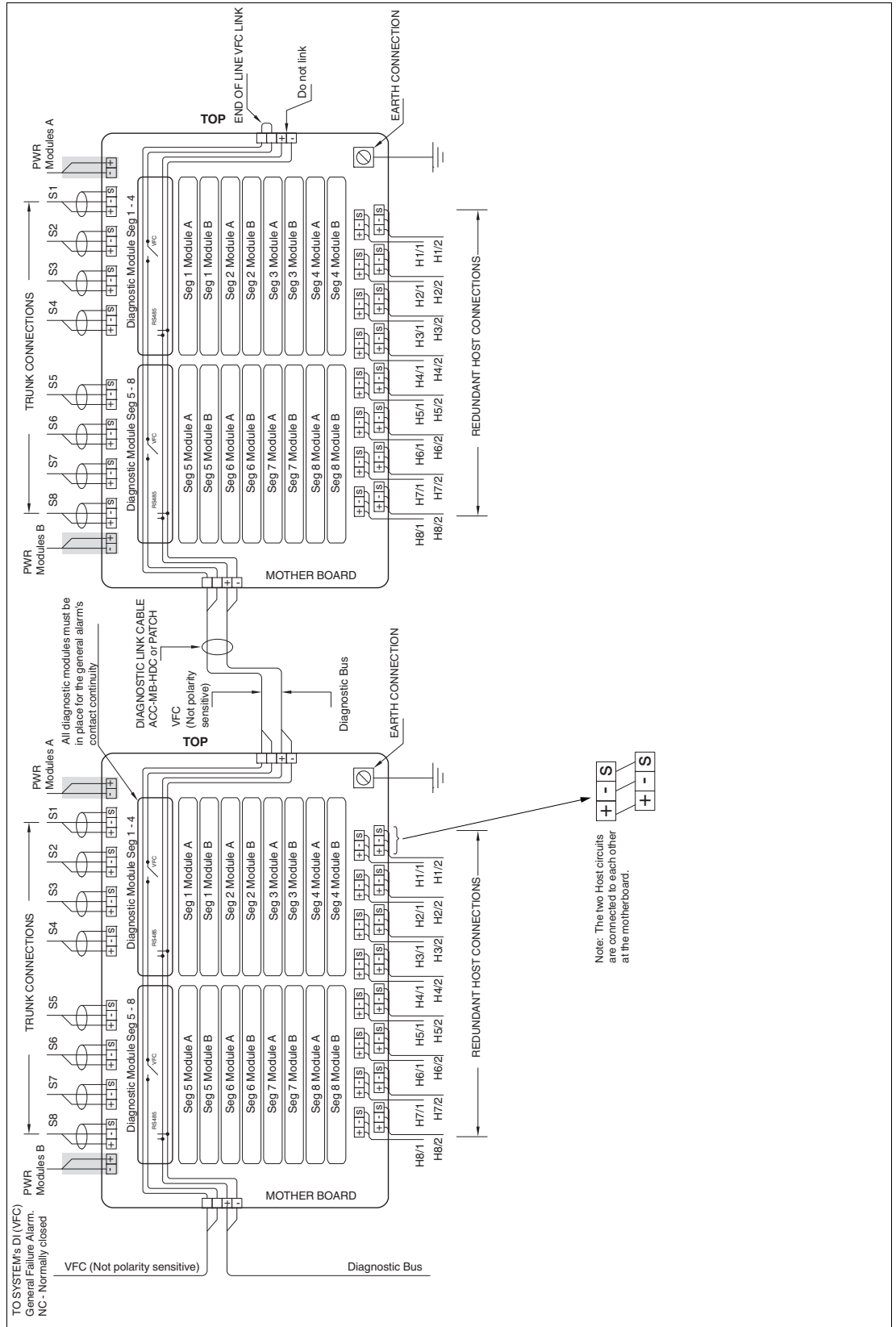

Note: The two Host circuits are connected to each other at the motherboard.

5.3 Ordering Information

Designation	Description
HCD2-FBPS-1.500	General purpose isolated power supply module with 28 ... 30 V DC and 500 mA output.
HCD2-FBPS-1.23.500	Ex ic isolated power supply module with 21 ... 23 V DC and 500 mA output.
HD2-DM-B	Basic diagnostic module with LED indication and common relay fault output.
HD2-DM-A	In combination with the FDT/DTM-based diagnostic manager, the advanced diagnostic module (ADM) allows for the analysis of signal and segment parameters as well as for the measurement of specific physical layer values concerning the system and node.
HD2-DM-A.RO	The advanced diagnostic module (ADM) relay output permanently monitors the physical layer. If a predefined threshold is exceeded, a built-in contact opens to alarm the operator via a system alarm input.
MBHC-FB-8R.RH*	Generic redundant segment motherboard for 8 segments with pluggable screw terminal connectors and with redundant host connection aligned left.
MBHC-FB-8R.RH.R*	Generic redundant segment motherboard for 8 segments with pluggable screw terminal connectors and with redundant host connection aligned right.

Accessories	
ACC-MB-HDC	Diagnostic link cable Coupling the diagnostic bus between 2 motherboards, length 6 cm.
ACC-MB-CC	Connector cover Set of 2 covers with special connectors to keep clearance distance between power and host terminals.
ACC-MB-HSK	Grounding rail and 4 cable clamps used to simplify shield connection at the trunk.

5.4 Electromagnetic Compatibility Verification in Accordance with EC Council Legislation Directive 2004/108/EC

Compatibility in Accordance with EN 61326-1 and NAMUR NE 21 Recommendation

The electromagnetic compatibility (EMC) requirements, applicable for electrical equipment for measurement, control, and laboratory use in general are anchored in the international standard EN 61326. 3 different performance criteria are distinguished in this standard:

A class **A** device operates as intended during the test. This device can withstand the immunity tests without any noticeable performance degradations within the specification limits of the manufacturer.

A class **B** device operates as intended after the test. The device shows temporary degradation or loss of function of performance during the test but self-recovers from that state when the exposures are ceased.

A class **C** device has loss of function. The device may need manual restoration. During the test a temporary loss of function is allowed, as long as an operator can restore the device back to operation.

The requirements of the association for standard and control and regulations of the German chemical industries, defined in the NE 21 recommendation, are partly higher compared to the test levels and failure criteria defined in EN 61326-1. For the product qualification, the failure criteria and test levels selected always represent the worst case conditions.

EN 61000-4, as a generic standard, defines the test setups for the specific required test for EN 61326-1 and NE 21.

See declaration of conformity for standards and editions applied.

Conducted EMC Tests

Immunity

Standard	Type	Test Level	Category
EN 61000-4-2	Electrostatic discharge, direct contact	6 kV	A
	Electrostatic discharge, indirect, air	8 kV	A
EN 61000-4-3	Electromagnetic field radiated, radio frequency	10 V/m	A
EN 61000-4-4	Fast transients burst on signal lines	1 kV	A
	Fast transients burst on power lines	2 kV	A
EN 61000-4-5	Slow transient surge on signal lines	1 kV	B
	Slow transient surge on shielded lines	2 kV	B
EN 61000-4-6	Conducted immunity, radio frequency	10 V	A
EN 55011	Reduction factor conducted emission	Class A	–
	Reduction factor radiated emission	Class A	–

5.5

Referenced Documents

- Manual: "Using Pepperl+Fuchs fieldbus equipment in Zone 2 hazardous area environment"
- Selection table: Conformity of FieldConnex[®] Power Hub modules and motherboards to Ex ic

PROCESS AUTOMATION – PROTECTING YOUR PROCESS



Worldwide Headquarters

Pepperl+Fuchs GmbH
68307 Mannheim · Germany
Tel. +49 621 776-0
E-mail: info@de.pepperl-fuchs.com

For the Pepperl+Fuchs representative
closest to you check www.pepperl-fuchs.com/contact

www.pepperl-fuchs.com

Subject to modifications
Copyright PEPPERL+FUCHS • Printed in Germany

 **PEPPERL+FUCHS**
PROTECTING YOUR PROCESS

/ TDOCT-2553D_ENG
10/2014