



QUICK START GUIDE

OHV100-F222-R2 Handheld reader



With regard to the supply of products, the current issue of the following document is applicable: The General Terms of Delivery for Products and Services of the Electrical Industry, published by the Central Association of the Electrical Industry (Zentralverband Elektrotechnik und Elektroindustrie (ZVEI) e.V.) in its most recent version as well as the supplementary clause: "Expanded reservation of proprietorship"

1	Purpose of this Quick Start Guide	5
2	Product Description	6
2.1	Use and Application	6
2.2	Indicators and Operating Controls.....	9
2.3	Scope of Delivery	10
2.4	Accessories.....	10
2.5	Storage and Disposal	11
3	Installation	12
3.1	Installing/Removing the Cable.....	12
3.2	Establishing a USB Connection	14
3.3	Establishing an RS-232 Connection.....	14
4	Operation	16
4.1	Reading Codes	16
4.2	Keyboard Mode.....	17
4.3	Keyboard Layout	18
4.4	Activating a Suffix.....	22
4.5	Operation Using a Bracket	24

1 Purpose of this Quick Start Guide

This quick start guide contains basic instructions for operating the device. However, the manual takes priority over the quick start guide.

2 Product Description

2.1 Use and Application

**Caution!**

Irritation caused by optical radiation

The optical unit on the handheld reader is equipped with very bright LEDs that can cause irritation in dark environments.

Do not point the handheld reader at people.

Do not look directly into the optical unit on the handheld reader.

The OHV100 handheld is a compact handheld reader for all common 1-D and 2-D codes. Special technology to prevent glare allows the device to accurately read codes on highly reflective surfaces. With its patented dual lens and a resolution of 1.2 million pixels, it can read both small and large codes from a wide range of distances. A different-colored target projection makes it easier to see the relevant code. Feedback comes in the form of a visual or audible signal or a vibration.

Using the Vision Configurator software, rule sets can be created for formatting read results without the need for extensive programming work. This facilitates integration into ERP systems. Data is transferred via USB or RS-232, depending on which connection cable is selected. With its robust housing and IP54 protection, the handheld reader is ideally suited to heavy-duty industrial use.



The device is only approved for appropriate and intended use. Ignoring these instructions will void any warranty and absolve the manufacturer from any liability.

Use the device only within the specified ambient and operating conditions.

Protection of the personnel and the plant is not ensured if the device is not being used according to its intended use.

2.2

Indicators and Operating Controls

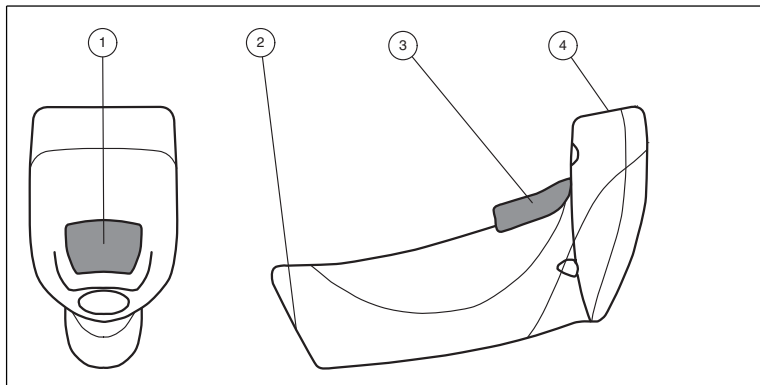

- 1 Function indicator
- 2 10-pin connector socket
- 3 Trigger button
- 4 Optical unit

2.3 Scope of Delivery

Check the packaging and contents for damage.

Check if you have received every item and if the items received are the ones you ordered.

- Handheld reader
OHV100-F222-R2
- Brief instructions

2.4 Accessories

Designation	Description
V45-G-2M-PVC-ABG-USB-G	Connection cable for USB connection, approx. 1.8 meters
V45-G-2M-PVC-SUBD9	Connection cable for RS-232 connection, approx. 2.4 meters (extended) Data connection: Sub-D socket, 9-pin Power supply: DC connector socket, 5.5 mm
ODZ-MAH-SUPPLY	Power supply for RS-232 connection 5 VDC, 1.2 A, short-circuit protected

Designation	Description
OHV-BRACKET	Table mounting bracket
Vision Configurator	Configuration software for camera-based sensors When using OHV handheld readers, you can download the software free of charge from www.pepperl-fuchs.com .

2.5 Storage and Disposal

Keep the original packaging. Always store and transport the device in the original packaging.

Store the device in a clean and dry environment. The permitted ambient conditions (see datasheet) must be considered.

Disposing of device, packaging, and possibly contained batteries must be in compliance with the applicable laws and guidelines of the respective country.

3

Installation

3.1

Installing/Removing the Cable



Installing the Cable

1. Hold the end of the cable with the RJ50 plug and insert the plug into the RJ50 socket underneath the handle.

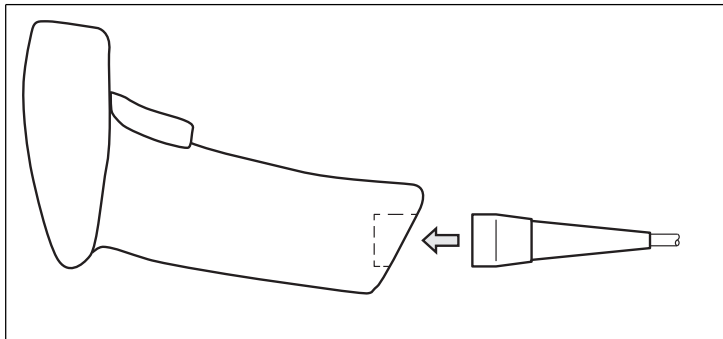

2. Make sure that the cable audibly snaps into place.



Removing the Cable

1. Insert a thin object such as a straightened paper clip into the hole at the bottom of the handle at the side.

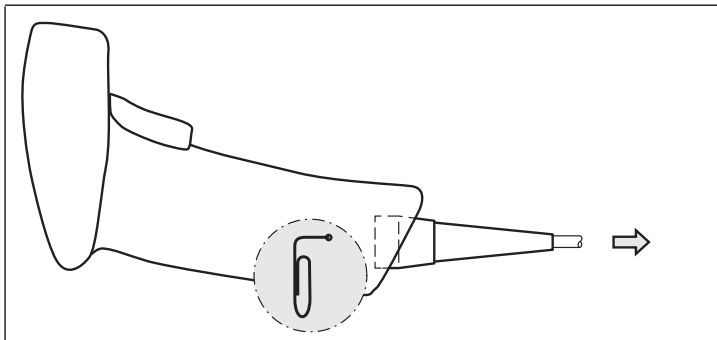

2. Carefully pull the cable complete with RJ50 plug out of the handle.

3.2 Establishing a USB Connection



Establishing a USB Connection

1. Insert the USB plug on the connection cable into a free USB port on the PC. This step can be carried out even during operation.
2. To switch on the handheld reader, hold down the trigger button for approx. two seconds.
3. When the handheld reader is successfully connected, an audible signal will be emitted and the handheld reader will vibrate.

↳ The handheld reader is now ready.

3.3 Establishing an RS-232 Connection



Establishing an RS-232 Connection

1. Switch off the PC.
2. Insert the RS-232 plug on the connection cable into the RS-232 port on the PC.
3. Insert the low-voltage plug on the power supply unit into the low-voltage socket on the RS-232 connection cable.
4. Connect the mains power plug on the power supply unit to the mains.

5. Switch on the PC.

↳ Once you have switched on the PC, the handheld reader will switch itself on automatically.

6. When the handheld reader is successfully connected, an audible signal will be emitted and the handheld reader will vibrate.

↳ The handheld reader is now ready.

The handheld reader uses the following RS-232 factory settings:

- 115,200 baud
- 8 data bits
- No parity

4 Operation

4.1 Reading Codes

The handheld reader reads both very small 2-D codes (e.g., Data Matrix codes) and larger 1-D codes (e.g., barcodes). The handheld reader offers a field of vision comprising two areas that can be read at the same time. This covers a read range between 4 cm and 31 cm. The optimal read range is 10 cm.

By default, the read range is indicated by two blue bars. However, you can deactivate the display of the blue bars.



Tip

If several codes are located right next to each other, we recommend you cover the codes that you do not wish to read. This prevents you from inadvertently reading another code.



Reading Codes

The handheld reader registers itself with other devices as an input device or keyboard. Before you read a code, start or activate the application to which the read result is to be transferred.

1. To read the code, hold the trigger button down.
2. Position the blue bars in the center of the code that you wish to read. Move the handheld reader closer to or farther away from the code until the height of the blue bars roughly corresponds to the height of the code.

↳ If the reading process is successful, the function indicator on the handheld reader briefly lights up green. When activated, an audible signal is emitted and the handheld reader vibrates.

4.2 Keyboard Mode

▶ Activating Keyboard Mode

Read the following code using the handheld reader.



M10200_01

↳ The function indicator on the handheld reader briefly lights up green.

Data is transferred using a US English keyboard layout by default.

If data is not transferred correctly in keyboard mode, modify the keyboard layout.
See chapter 4.3

4.3 Keyboard Layout

You can use the following control codes to modify the keyboard layout for the current operating mode.



Microsoft Windows

English (US)



M10460_02

English (US International)



M10469_01

English (GB)



M10471_01

German (Germany)



M10463_02

German (Switzerland)



M10466_02

French (France)



M10462_02



French (Belgium)

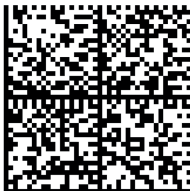

M10461_02

Spanish (Spain)

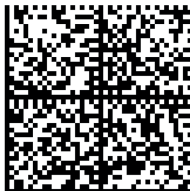

M10472_01

Spanish (Latin America)



M10465_02

Russian

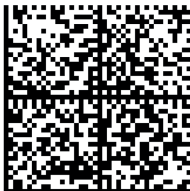

M10418_02

Japanese



M10464_02



Apple OS X and iOS

English

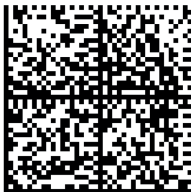

M10419_02

German (Germany)



M10421_02

German (Switzerland)



M10422_02

French

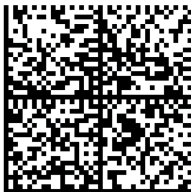

M10420_02

Spanish

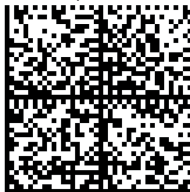

M10424_02

Italian







M10423_02



4.4 Activating a Suffix

In order to add a suffix to a read result, read the respective code with the handheld reader.

Suffixes

Code	Description
Suffix comma  M10131_01	Adds a comma to the end of the read result.
Suffix space  M10132_01	Adds a space to the end of the read result.

Code	Description
<p>Suffix enter (USB connection)</p>  <p>M10134_01</p>	<p>Adds an input character to the end of the read result. Use this code when the handheld reader is connected to the PC via the USB interface.</p>
<p>Suffix ENTER (RS-232 connection)</p>  <p>M10322_01</p>	<p>Adds an input character to the end of the read result. Use this code when the handheld reader is connected to the PC via the RS-232 interface.</p>
<p>Suffix TAB (USB connection)</p>  <p>M10133_01</p>	<p>Adds a tab character to the end of the read result. Use this code when the handheld reader is connected to the PC via the USB interface.</p>

Code	Description
Suffix TAB (RS-232 connection)  M10323_01	Adds a tab character to the end of the read result. Use this code when the handheld reader is connected to the PC via the RS-232 interface.
Suffix erase/none  M10130_01	Removes all suffixes.



4.5 Operation Using a Bracket



The handheld reader features a motion detection system. If motion detection is activated, the handheld reader automatically attempts to read a code as soon as motion is detected in the read range. It is not necessary to activate the trigger button.





If using the OHV-BRACKET, the handheld reader is set ex works in such a way that motion detection is automatically activated when the handheld reader is inserted into the bracket, and automatically deactivated when the handheld reader is removed from the bracket. However, you are able to change this setting.



<p>Motion detection on when in bracket Motion detection off when out of bracket</p>  <p>M10403_02</p>	<p>Activates automatic activation of motion detection when the handheld reader is inserted into the OHV-BRACKET.</p>
<p>Motion detection on</p>  <p>M10404_02</p>	<p>Activates motion detection regardless of whether the handheld reader is in the OHV-BRACKET fixture or not.</p>
<p>Motion detection off</p>  <p>M10013_02</p>	<p>Disables motion detection regardless of whether the handheld reader is in the OHV-BRACKET fixture or not.</p>

<p>Optimize motion detection for bright environments</p>  <p>M10014_03</p>	<p>Optimizes motion detection for bright environments.</p>
<p>Optimize motion detection for dark environments</p>  <p>M10015_03</p>	<p>Optimizes motion detection for dark environments.</p>



<p>No motion detection delay</p>  <p>M10016_03</p>	<p>Sets the start delay for motion detection to 0 ms.</p>
<p>500 ms motion detection delay</p>  <p>M10017_03</p>	<p>Sets the start delay for motion detection to 500 ms.</p>

FACTORY AUTOMATION – SENSING YOUR NEEDS



Worldwide Headquarters

Pepperl+Fuchs GmbH
68307 Mannheim · Germany
Tel. +49 621 776-0
E-Mail: info@de.pepperl-fuchs.com

USA Headquarters

Pepperl+Fuchs INC
Twinsburg, Ohio 44087 · USA
Tel. +1 330 4253555
E-Mail: sales@us.pepperl-fuchs.com

Asia Pacific Headquarters

Pepperl+Fuchs Pte Ltd.
Company Registration No. 199003130E
Singapore 139942
Tel. +65 67799091
E-Mail: sales@sg.pepperl-fuchs.com

www.pepperl-fuchs.com

Subject to modifications • Copyright Pepperl+Fuchs • Printed in Germany



 **PEPPERL+FUCHS**
SENSING YOUR NEEDS

254420

TDOCT-2954DENG

11/2015