

# H-System

## Isolated Barriers and Termination Boards for Yokogawa ProSafe-RS

Brief Instructions



Your automation, our passion.

 **PEPPERL+FUCHS**

---

With regard to the supply of products, the current issue of the following document is applicable:  
The General Terms of Delivery for Products and Services of the Electrical Industry, published by the Central Association of the Electrical Industry (Zentralverband Elektrotechnik und Elektroindustrie (ZVEI) e.V.) in its most recent version as well as the supplementary clause: "Expanded reservation of proprietorship"

### **Worldwide**

Pepperl+Fuchs Group

Lilienthalstr. 200

68307 Mannheim

Germany

Phone: +49 621 776 - 0

E-mail: [info@de.pepperl-fuchs.com](mailto:info@de.pepperl-fuchs.com)

### **North American Headquarters**

Pepperl+Fuchs Inc.

1600 Enterprise Parkway

Twinsburg, Ohio 44087

USA

Phone: +1 330 425-3555

E-mail: [sales@us.pepperl-fuchs.com](mailto:sales@us.pepperl-fuchs.com)

### **Asia Headquarters**

Pepperl+Fuchs Pte. Ltd.

P+F Building

18 Ayer Rajah Crescent

Singapore 139942

Phone: +65 6779-9091

E-mail: [sales@sg.pepperl-fuchs.com](mailto:sales@sg.pepperl-fuchs.com)

<https://www.pepperl-fuchs.com>

<b>1</b>	<b>Introduction</b> .....	<b>5</b>
1.1	Content of this Document .....	5
1.2	Target Group, Personnel .....	5
<b>2</b>	<b>Product Specifications</b> .....	<b>6</b>
2.1	Function .....	6
2.2	Isolated Barriers .....	6
2.3	Termination Boards .....	6
<b>3</b>	<b>Technical Specifications</b> .....	<b>10</b>
3.1	Model Number Description Termination Boards .....	10
3.2	Dimensions .....	11



# 1 Introduction

## 1.1 Content of this Document

This document contains control-system specific information about:

- Connection options
- Status indications
- Product identification
- Dimensions



**Note**

See system manual for further information.

---



**Note**

This document does not substitute the instruction manual.

---



**Note**

For full information on the product, refer to the instruction manual and further documentation on the Internet at [www.pepperl-fuchs.com](http://www.pepperl-fuchs.com).

---



**Note**

For specific device information such as the year of construction, scan the QR code on the device. As an alternative, enter the serial number in the serial number search at [www.pepperl-fuchs.com](http://www.pepperl-fuchs.com).

---

## 1.2 Target Group, Personnel

Responsibility for planning, assembly, commissioning, operation, maintenance, and dismounting lies with the plant operator.

Only appropriately trained and qualified personnel may carry out mounting, installation, commissioning, operation, maintenance, and dismounting of the product. The personnel must have read and understood the instruction manual and the further documentation.

Prior to using the product make yourself familiar with it. Read the document carefully.

## 2 Product Specifications

### 2.1 Function

Isolated barriers are used to protect intrinsically safe circuits in explosive areas. In addition to the required current, voltage and power limitation, the isolated barriers have a galvanic isolation between the field circuit and the controller.

The H-System isolated barriers are mounted on termination boards. Pre-wiring is possible on termination boards. To close the signal circuit, the isolated barriers are simply plugged in. The isolated barriers can be replaced during live operation when the wiring is connected.

Generic and control-system specific termination boards are available in the H-System. Termination boards can be adapted to specific input/output requirements. These requirements can be implemented via

- Various connecting plugs to the controller
- Various terminals to the field device
- A large selection of isolated barriers

### 2.2 Isolated Barriers

H-System isolated barriers cover all functions and the interoperability of the H-System.

The pin assignment and terminal designations are consistent for all termination boards. Each H-System isolated barrier can therefore be mounted in each termination board slot.

The termination board can be coded together with the isolated barriers. This prevents the isolated barriers being mixed up on the termination board. The safety-relevant data for the connected field devices is backed up.

---

#### Note

See system manual for further information.

---



### 2.3 Termination Boards

Termination boards form the wiring level for field and control signals. The isolated barriers are mounted on termination boards. The isolated barriers are connected with the field and control side via the termination boards. Once the isolated barrier is mounted, the signal circuit between the field and control side is closed.

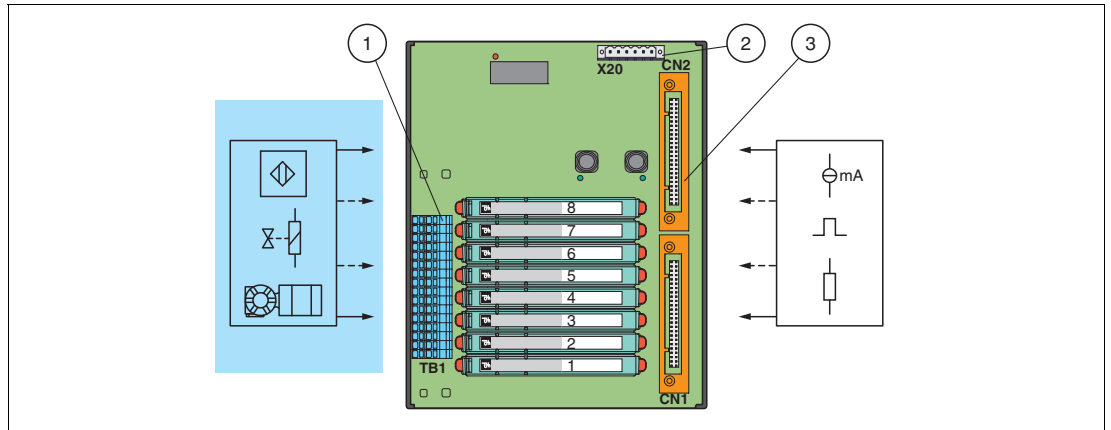

Figure 2.1 Connection example termination board with 8 slots

- 1 Field side connection
- 2 Connection power supply and fault indication output
- 3 Control side connection

Features depending on version

- With 8 or 16 slots
- For redundant and fused power supply
- For fault monitoring and diagnostics

### 2.3.1 Connection Options

A variety of termination boards is available with different methods of connecting to the field and control side. Please refer to the documentation for the respective device for the specific connection layout.

#### Connecting the Field Side

The field devices can be connected to the termination board with the following connection options:

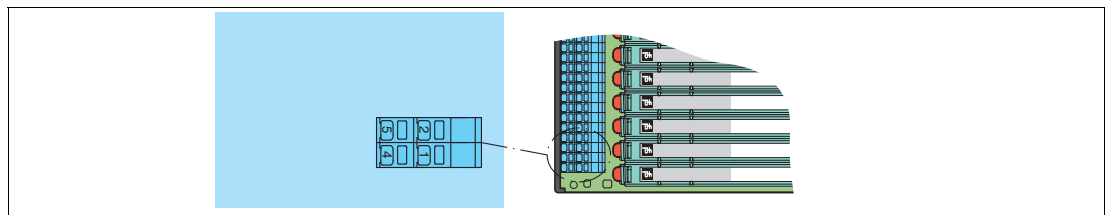

Figure 2.2 Spring terminals, double-row

### Connecting the power supply and Fault Indication Output

#### Isolated Barriers

The isolated barriers are supplied via the termination board. The isolated barriers are therefore attached to the termination board.

#### Termination boards

The termination boards are supplied with power via pluggable screw terminals.

The supply voltage range depends on

- The values used for the isolated barriers
- The voltage drop of the decoupling diodes on the termination board

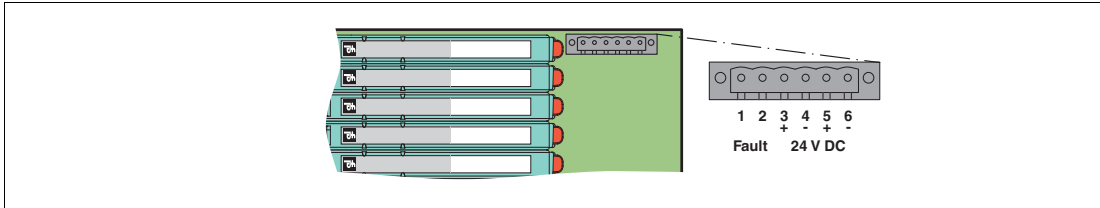

Figure 2.3 Connection of power supply and fault indication output via screw terminals

### Connecting the Control Side

The termination board on the control side can be connected via the following connection options:

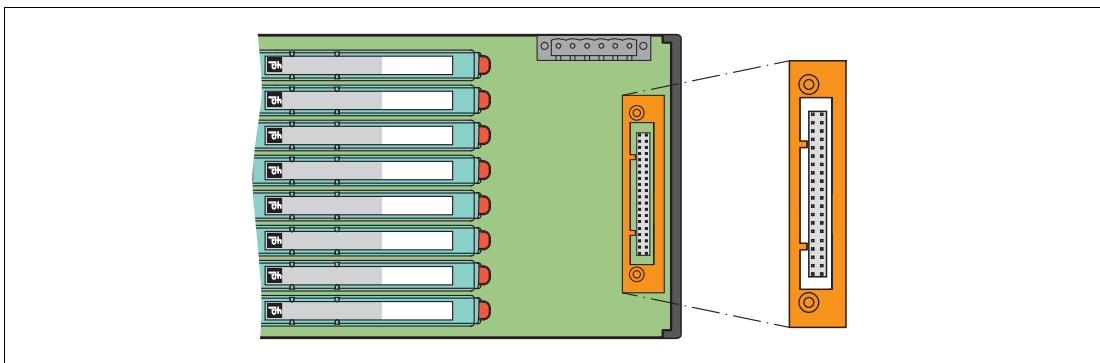

Figure 2.4 Yokogawa system connector, 40-pin

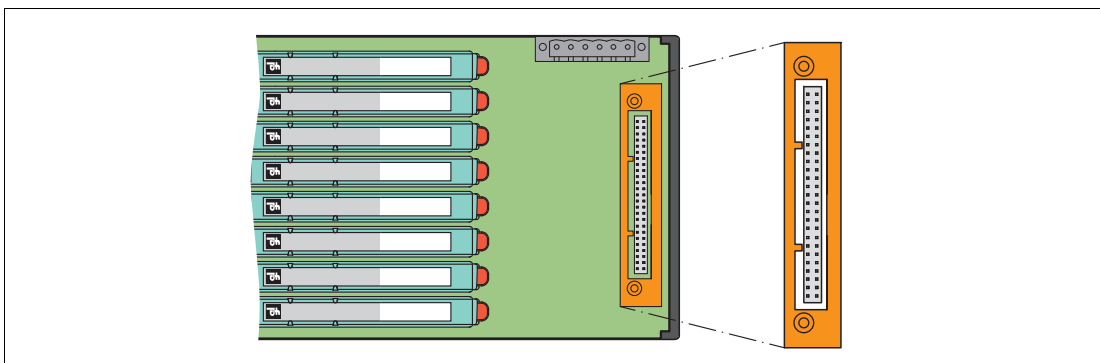

Figure 2.5 Yokogawa system connector, 50-pin

#### Note

See corresponding datasheets for further information.







**Note**

See system manual for further information.

**2.3.2 Status Indicators of Termination Boards**

LEDs are often used on termination boards to indicate different statuses (e. g. for power supply, device failure, status messages). Standard LED colors are assigned to the status display according to NAMUR NE 44.

LED	Display function	Display	Meaning
Green LED <b>PW1</b>	Power supply I	On	Power supply OK
		Off	No power
Green LED <b>PW2</b>	Power supply II	On	Power supply OK
		Off	No power
Red LED <b>FAULT</b>	Power supply failure	Flashing	Power failure or insufficient power supply

Table 2.1 Meaning of status indicators

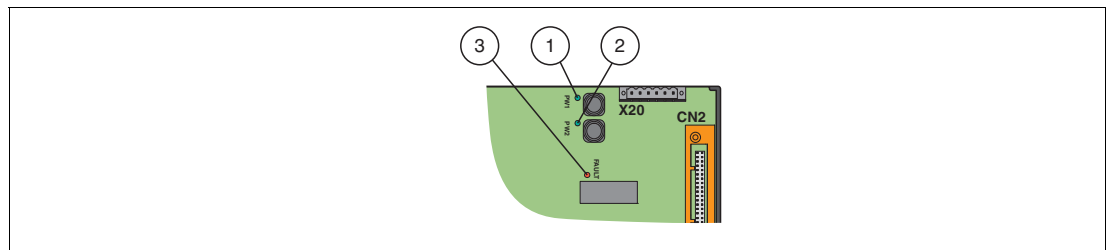

Figure 2.6 Example status indicators

- 1 Green LED **PW1**  
Status indicator power supply I
- 2 Green LED **PW2**  
Status indicator power supply II
- 3 Red LED **FAULT**  
Power failure or insufficient power supply



**Note**

See system manual for further information.



### 3.2 Dimensions

#### 3.2.1 Housing Types Termination Boards

##### Termination Board for 8 Modules

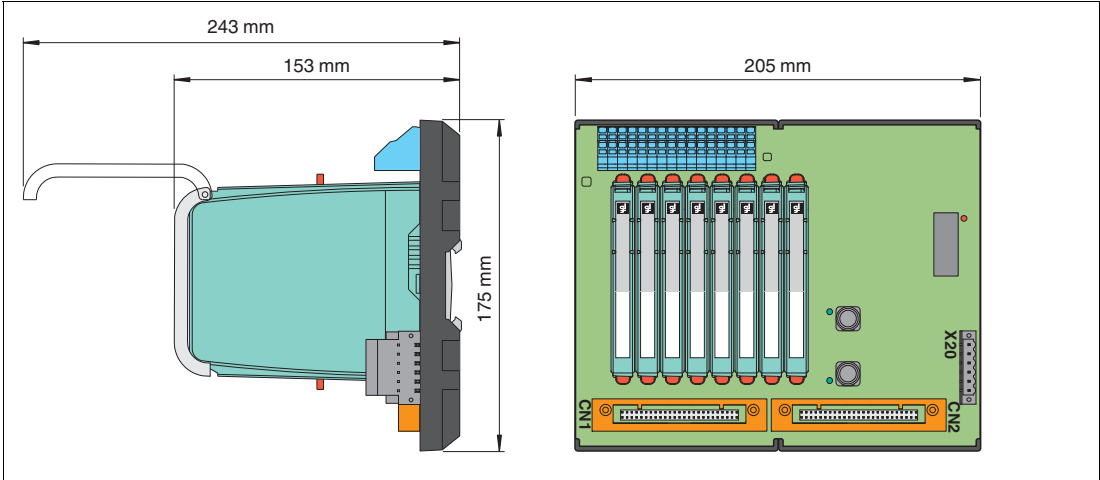

Figure 3.1 Dimensions (W x H x D): 205 x 175 x 153 mm (8.0 x 6.9 x 6.0 inch), depth including module assembly

##### Termination Board for 16 Modules

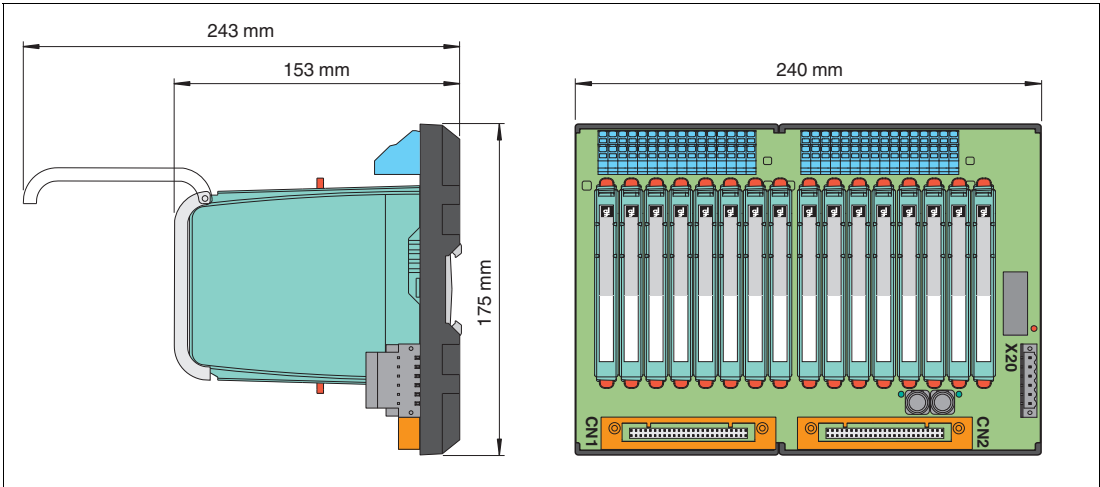

Figure 3.2 Dimensions (W x H x D): 240 x 175 x 153 mm (9.5 x 6.9 x 6.0 inch), depth including module assembly



**Note**  
See system manual for further information.

# Your automation, our passion.

## Explosion Protection

- Intrinsic Safety Barriers
- Signal Conditioners
- FieldConnex® Fieldbus
- Remote I/O Systems
- Electrical Ex Equipment
- Purge and Pressurization
- Industrial HMI
- Mobile Computing and Communications
- HART Interface Solutions
- Surge Protection
- Wireless Solutions
- Level Measurement

## Industrial Sensors

- Proximity Sensors
- Photoelectric Sensors
- Industrial Vision
- Ultrasonic Sensors
- Rotary Encoders
- Positioning Systems
- Inclination and Acceleration Sensors
- Fieldbus Modules
- AS-Interface
- Identification Systems
- Displays and Signal Processing
- Connectivity

### Pepperl+Fuchs Quality

Download our latest policy here:

[www.pepperl-fuchs.com/quality](http://www.pepperl-fuchs.com/quality)

