

Manual

**Commissioning
IDENTControl IC-KP-B12-
V45 and IC-KP-B17-AIDA1
with PROFINET Protocol
to Siemens S7 Controller**



With regard to the supply of products, the current issue of the following document is applicable: The General Terms of Delivery for Products and Services of the Electrical Industry, published by the Central Association of the Electrical Industry (Zentralverband Elektrotechnik und Elektroindustrie (ZVEI) e.V.) in its most recent version as well as the supplementary clause: "Expanded reservation of proprietorship"

1	Setting Communication Parameters via Web Interface	5
2	Installing the GSDML File	7
3	Installing the User Program	8
4	Hardware Configuration	9
5	Setting Device Parameters	12
6	Function Block „FB190_IUHParam“	13
6.1	Reset to Default: Channel 1	16
6.2	PowerTransmit - PT: Channel 1	18
6.3	ChannelDenseReaderMode - CD: Channel 1	18
6.4	Read/Write Multiple Parameters: Channel 1	19
7	Funktion Block FB32 „Singleframe“	21
8	Error or Device Diagnostics	25
9	Examples Command Execution	26
9.1	Initialization: (with tag type IUC72)	26
9.2	Single Read Fixcode: (Head 1)	27
9.3	Enhanced Read Fixcode: (Head 1)	28
9.4	Single Read Words: (Head 1; 15 Blocks from Address 0)	29
9.5	Enhanced Read Words: (Head 1; 15 Blocks from Address 0)	30
9.6	Single Read SpecialFixcode: (Head 1)	31
9.7	Enhanced Read SpecialFixcode: (Head 1)	32
9.8	Single Write Words: (Head 1; 15 Blocks from Address 0)	33
9.9	Enhanced Write Words: (Head 1; 15 Blocks from Address 0)	34
9.10	Single Write Fixcode: (Head 1; IPC11)	35
9.11	Single Write SpecialFixcode: (Head 1)	36
9.12	Error Handling: (Head 1)	37



9.13	Command List (Prefetch): (Head 1)	37
10	Table of Read/Write Tags	41
11	Table of Status Values	43
12	Table of Version History	44

1 Setting Communication Parameters via Web Interface

The following communication parameters are predefined by default in the IC-KP-B12-V45:

IP address: 172.16.177.0
 Gateway address: 172.16.11.222
 Subnet mask: 255.255.0.0
 PROFINET name: PF-IDENTControl

The following communication parameters are predefined by default in the IC-KP-B17-AIDA1:

IP address: 169.254.10.12
 Gateway address: 169.254.254.1
 Subnet mask: 255.255.0.0
 PROFINET name: IDENTControl

The communication parameters can be changed on the device itself by selecting the following menu items: IDENTControl → IDENT Gateway → Setting network → Setting IP Address (Subnet Mask; Standard Gateway)

Restart to activate the new parameters.

There is also the option to set the communication parameters via the internal device website. The website can be accessed via a web browser and the default IP address.

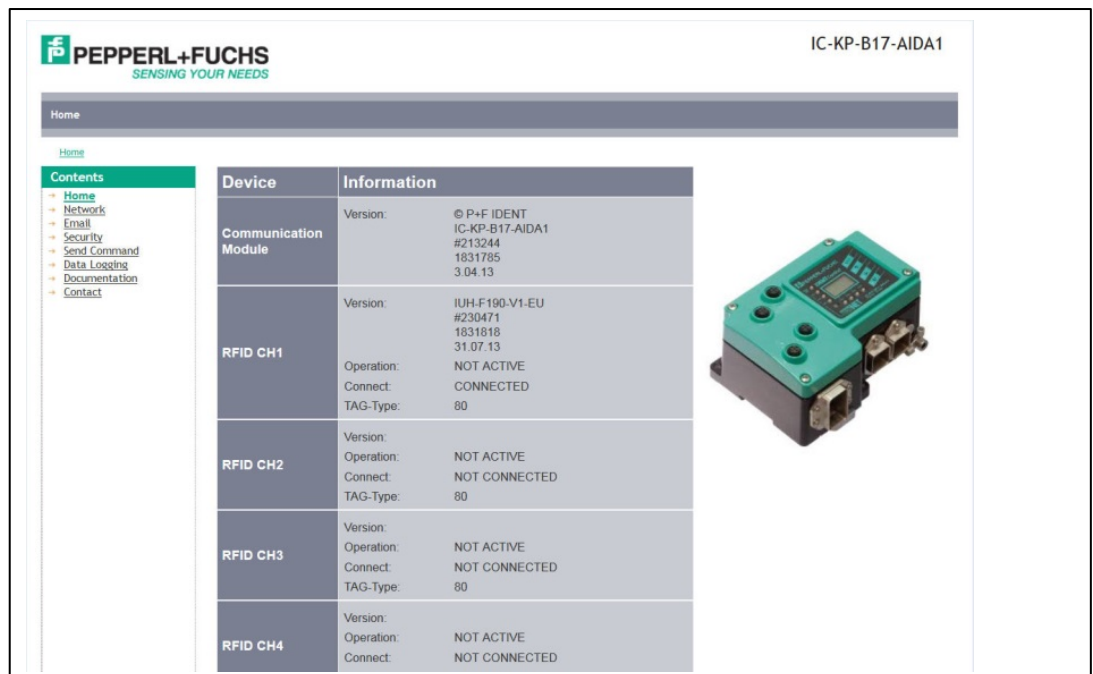

The communication parameters can be configured by selecting "Network".

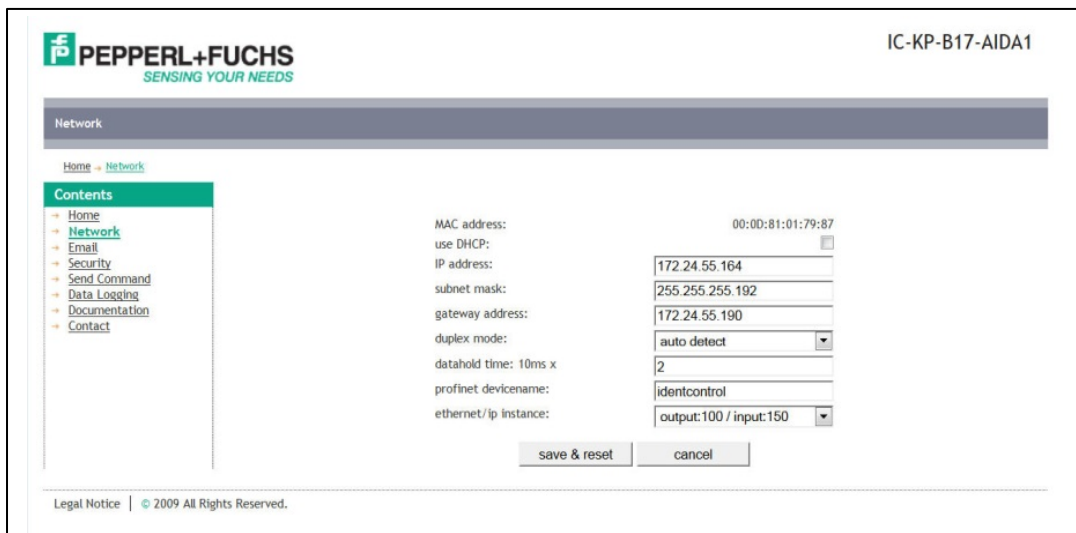

The parameters are applied to the device by selecting "Save & Reset". The device will then restart automatically.

The PROFINET name can be assigned using the controller. To assign a name, select the following options in the hardware configuration menu: PLC → Ethernet → Edit Ethernet Node.

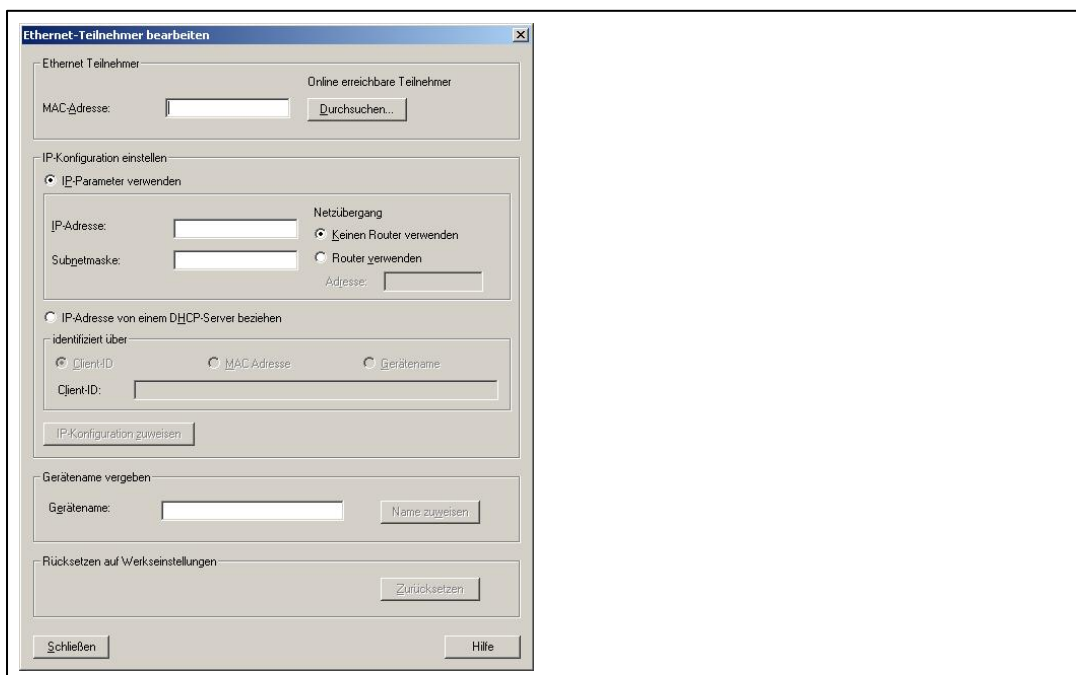

Search for connected nodes in the PROFINET IO system by selecting "Browse...". If there are multiple PROFINET nodes, they can be identified via the "Flash" function. The IP configuration must then be adjusted; it is possible to specify whether a fixed IP address is assigned, or whether the IP address is obtained dynamically from a DHCP server. Finally, the device must be assigned a unique PROFINET name.

2 Installing the GSDML File

Before commissioning the IDENTControl identification system for the first time, the GSDML file must first be installed. The GSDML file can be found on the "Identification Systems" CD packaged with the product. The file can also be downloaded from the Internet.

www.pepperl-fuchs.com

(Product search → IC-KP-B12-V45 → Documents → 1830920.zip)

(Product search → IC-KP-B17-AIDA1 → Documents → 1831801.zip)

To install the file, select menu item "Options" → "Install GSD File..." from the Simatic hardware configuration menu.

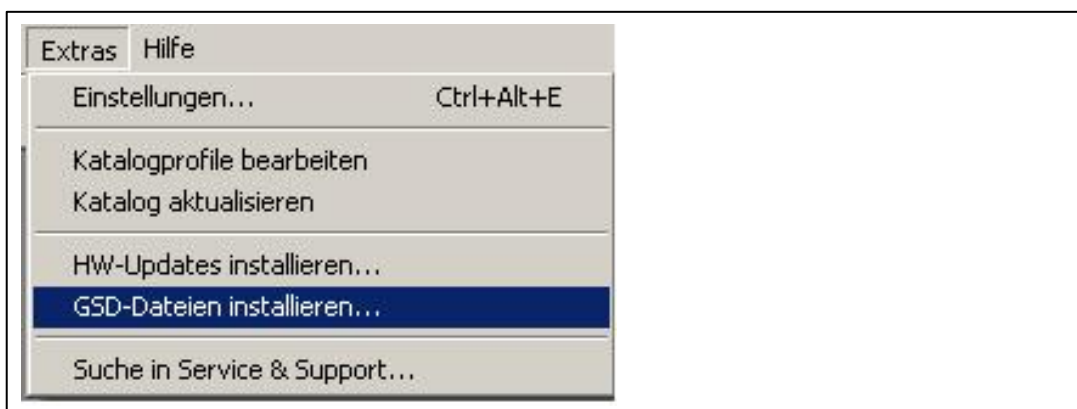

Then select the GSDML file from the source directory.

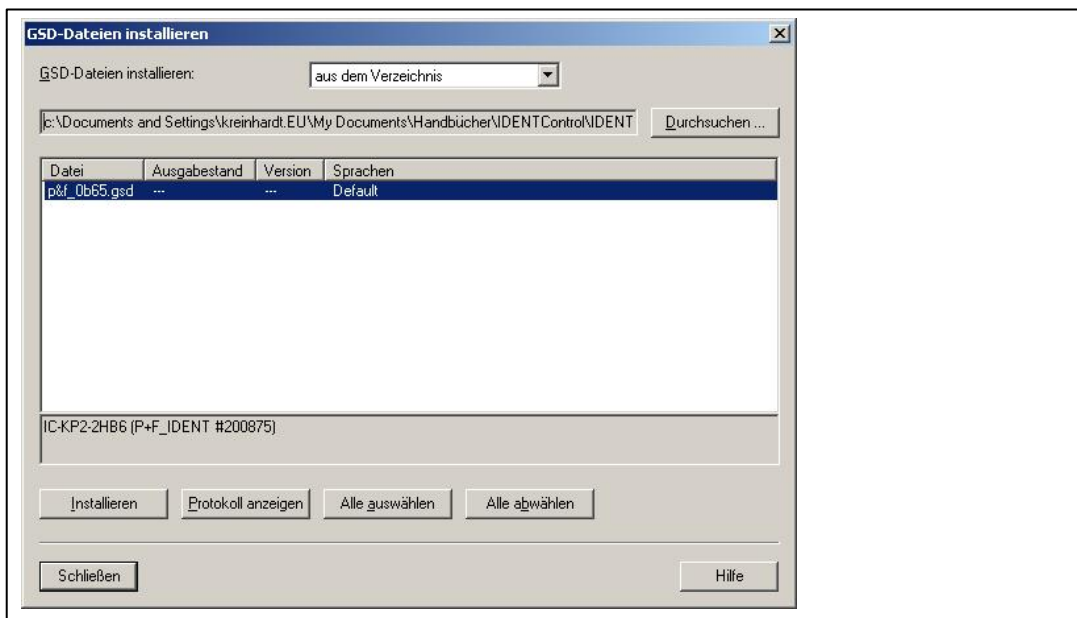

The GSDML file is added to the hardware catalog via the menu item "Options" → "Update Catalog".

3 Installing the User Program

Before the user program can be installed, the file "IC-KP-B12_PN.zip" must first be unzipped. Unzip the file by selecting the menu item "File" → "Retrieve..." in SIMATIC Manager. Highlight the file, confirm with "Open", and select the relevant file path. Following successful installation, the user program will appear within SIMATIC Manager.

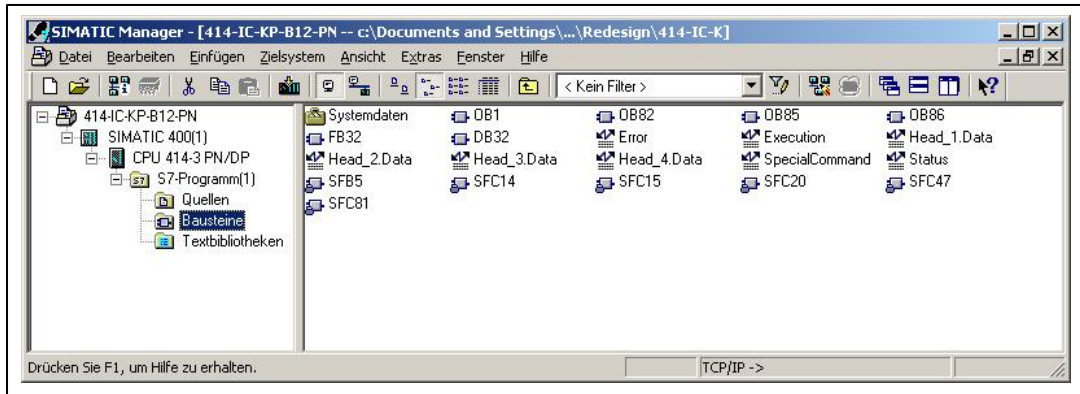

4 Hardware Configuration

The existing modules must be parameterized within the hardware configuration menu.

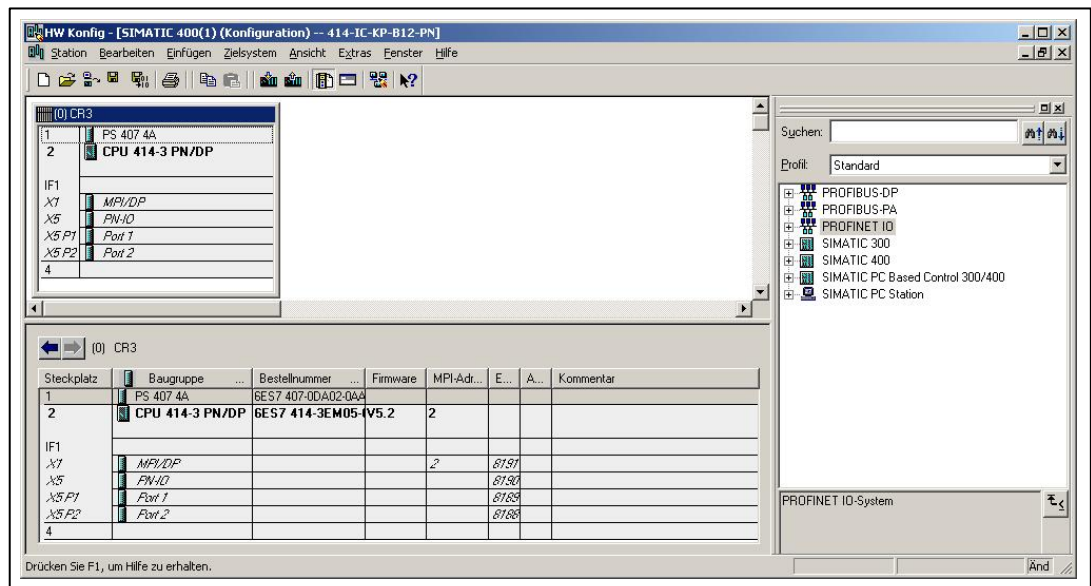

Add a PROFINET IO system by right-clicking on the PROFINET port.

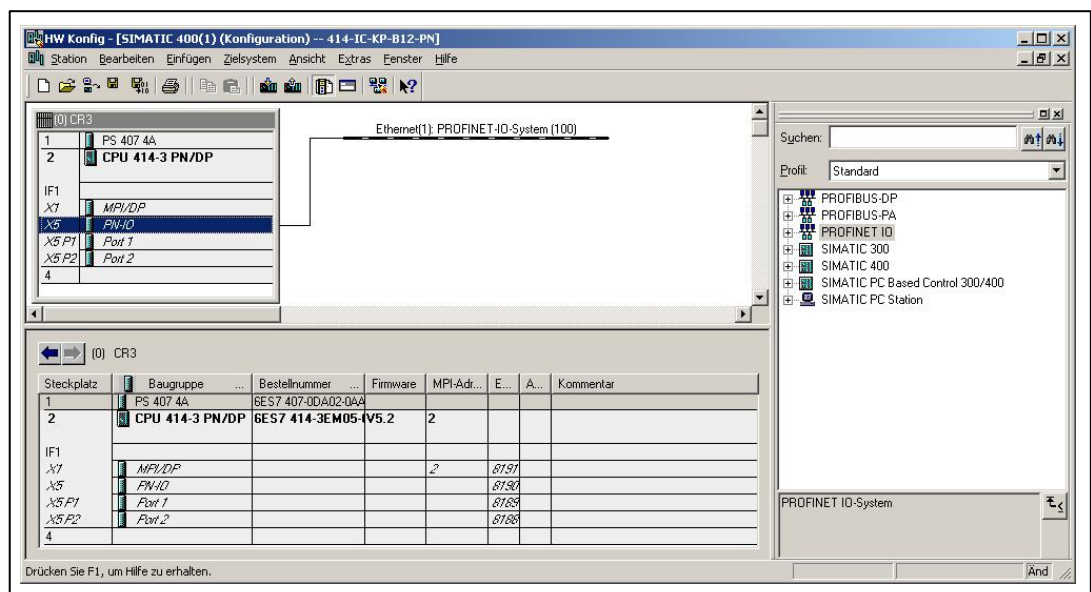

IDENTControl is then connected to the PROFINET IO system by dragging and dropping the "IC-KP-B12" (or "IC-KP-B17") icon from the hardware catalog to the master system. The telegram length is then defined by the communication blocks (e.g., In/Out 64 bytes). The module must be assigned to a slot.

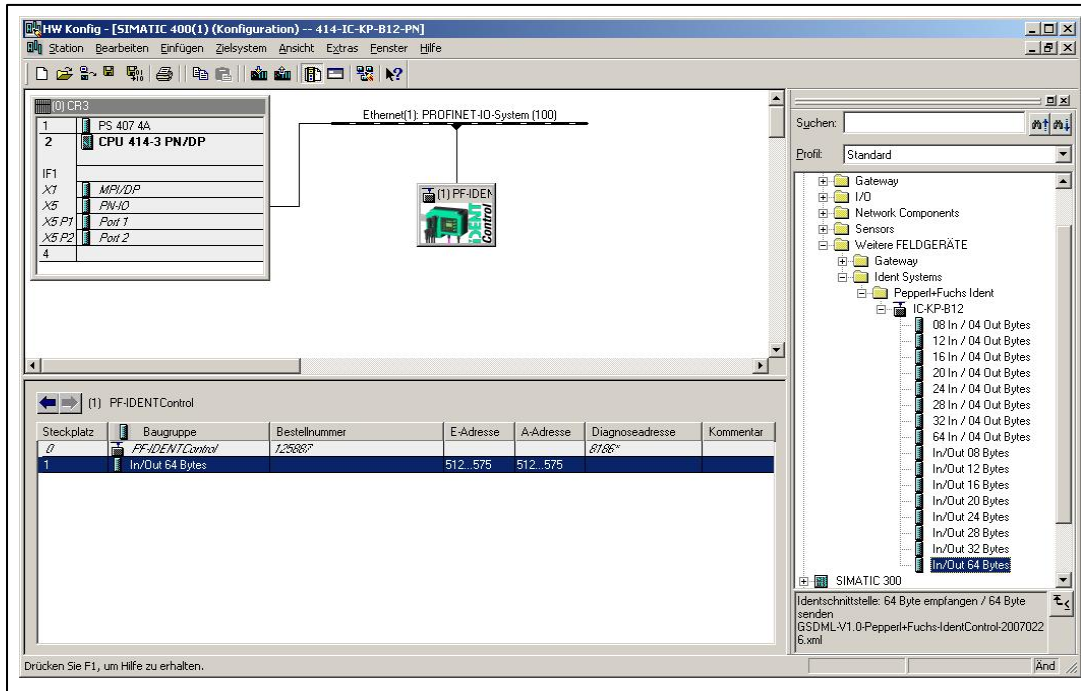

Double-click the IDENTControl icon to open a window containing the properties of the PROFNET node. The name of the PROFNET node (in this case: identcontrol) can be changed in this window if required.

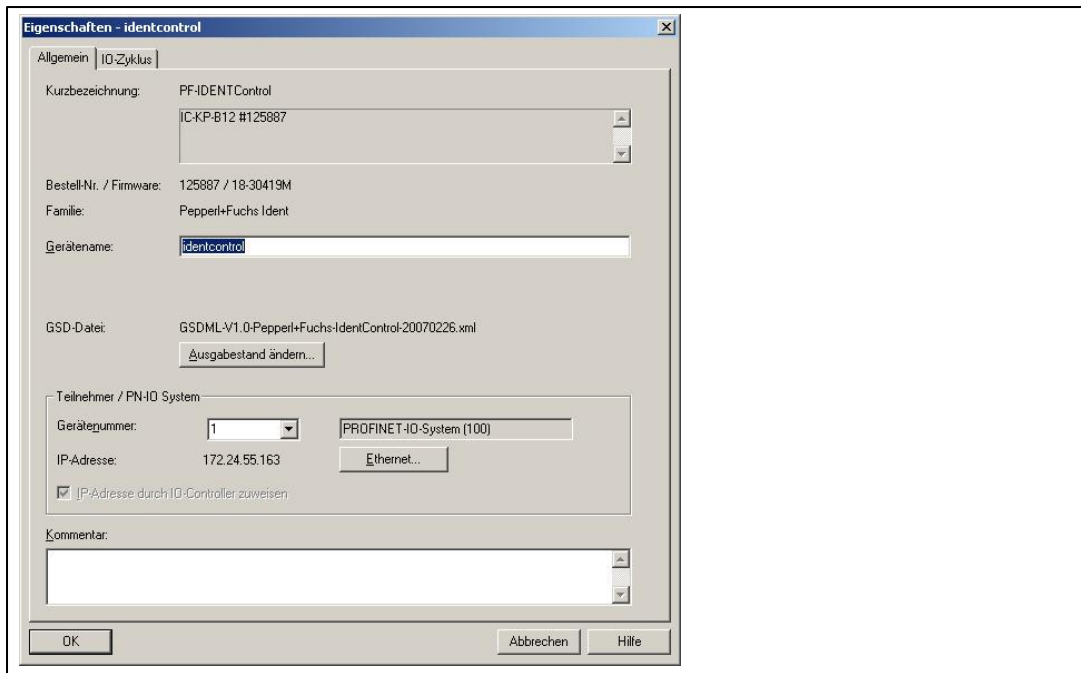

Selecting "Ethernet" allows you to change the IP address of the node.

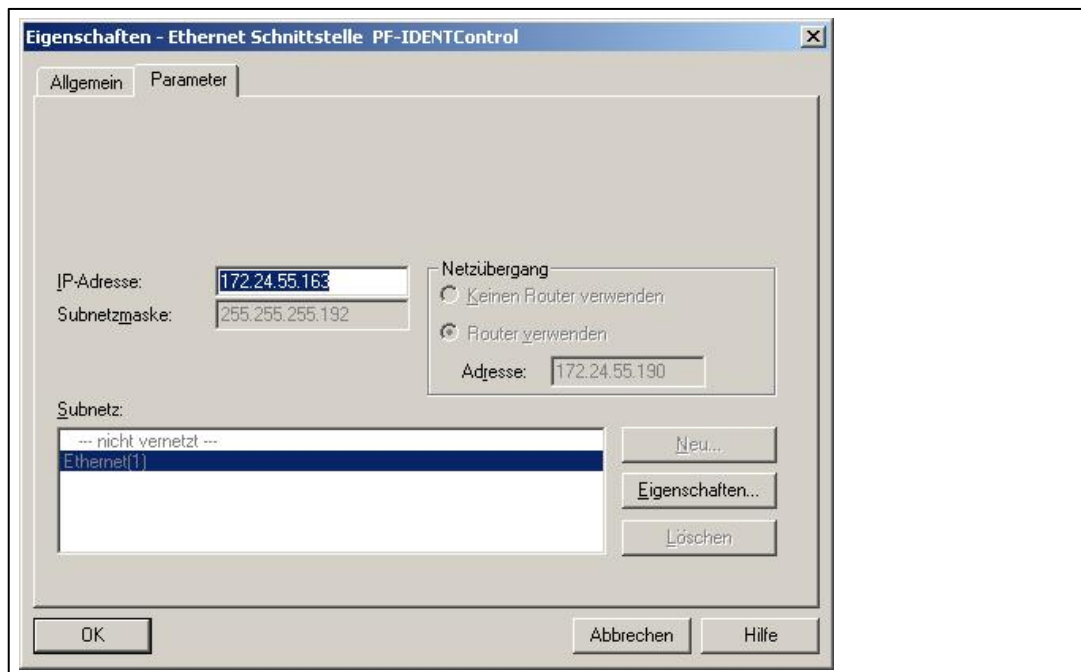

If the function block is transferred to another application program, it is recommended that the symbol table also be copied to the new program. The symbol information will support working processes.

5 Setting Device Parameters

The device parameters can be accessed by double-clicking slot 0 of the I/O table.

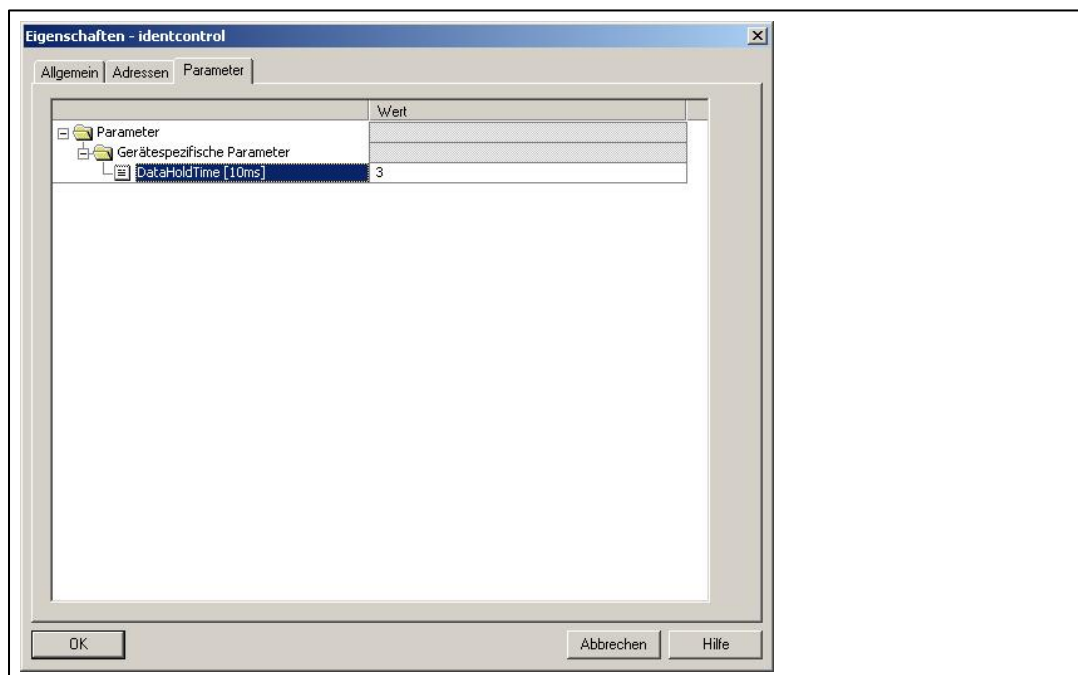

The device-specific parameter "DataHoldTime" (DHT) describes the data hold time within the output data field of the IDENTControl. The DHT should be twice the value of the cycle time of the controller. It is important to note that the value of the DHT is a multiple of 10 ms. If the cycle time in the controller is approximately 20 ms, a DHT value of at least 4 should be selected.

Note: The DHT value during the initial connection (i.e., the default value) for the IC-KP-B12-V45 = "0". For the IC-KP-B17-AIDA1 device, the default setting is the value "2".

6 Function Block „FB190_IUHParam“

The FB190 is used to parameterize the IUH-F190 and IUH-F117 readers. The block and the associated instance data block is opened as follows:

Call "FB190_IUHParam", "DB190_IUHParam" (symbolic representation)

or

Call FB190, DB190

To activate the function block, "ParameterEnable" must be active. If "NormalEnable" is active, then this must first be reset.

This block supports control interfaces with up to two channels.

The following figure shows the function being accessed, as well as the variables requiring parameterization.

```
CALL "FB190_IUHParam" , "DB190_IUHParam"
HeadNumber           := "HeadxNumber"
ReadWriteParameter   := "ReadWriteParameter"
PowerTransmit        := "PowerTransmit"
TriesAllowed         := "TriesAllowed"
ChannelDenseReaderMode := "Channel Dense Reader"
ProtocolMode         := "Protocol Mode"
Information           := FALSE // Input not supported for singleframe-mode
QValue              := "Q-Value"
NumberOfTags         := "Number of Tags"
SensingMode          := "Sensing Mode"
MemoryBank           := "Memory Bank"
MeasureReflection    := "Measure Reflection"
AdditionalInformation := "Information Single"
ResetToDefault       := "Reset to Default"
FilterList           := FALSE // Input not supported for singleframe-mode
EnhancedStatus5      := "EnhancedStatus5"
AntennaPolarisation := "AntennaPolarisation"
ParamFinished        := "ParamFinished"
ParamError           := "ParamError"
ParamTypeError       := "ParamTypeError"
ParamBusy            := "ParamBusy"
ParamStart           := "ParamStart"
```

Name	Decla-ration	Data type	Description
HeadNumber	Input	BYTE	Head/channel number on which parameters are to be read/written
ReadWriteParameter	Input	BOOL	Execution of 0:= read, 1:= write parameters
PowerTransmit	Input	BOOL	Access to reader transmission power
TriesAllowed	Input	BOOL	Access to read/write attempts
ChannelDenseReaderMode	Input	BOOL	Access to the sequence of transmission channels permitted in dense reader mode (DRM)
ProtocolMode	Input	BOOL	Access to output protocol (singleframe and multiframe)

QValue	Input	BOOL	Access to Q-value used to define the time slots used (2 ⁴) for anti-collision (Slotted Aloha)
NumberOfTags	Input	BOOL	Access to the number of tags in the detection range for which the read/write head is searching
SensingMode	Input	BOOL	Access to pause time in ms, after all runs are complete
MemoryBank	Input	BOOL	Access to the bank that the read/write commands SR, ER, SW, and EW are accessing
MeasureReflection	Input	BOOL	Access to measured reflected transmission power (read only)
AdditionalInformation	Input	BOOL	Access to output of additional information, provided that the reading was successful and the singleframe protocol has been set (read only)—not in multiframe operation!
Reset to Default	Input	BOOL	Returns all settings of the read/write head to the default configuration
Enhanced Status 5	Input	BOOL	Sets the number of unsuccessful write/read attempts before a status 5 is output for an advanced command
Antenna Polarisation	Input	BOOL	Switches the polarization to linear or circular
ParamStart	Output	BOOL	Execution of parameter command (positive edge)
ParamFinished	Output	BOOL	Parameter access terminated
ParamError	Output	BOOL	An error occurred
ParamTypeError	Output	WORD	Return of the incorrect parameter type (HEX)
ParamBusy	Output	BOOL	Individual parameter command is currently being executed



Note!

In the default state of the read/write head (IUH-F190), multiframe mode is activated. A write command must first be carried out on the protocol mode "ProtocolMode" in order to switch to singleframe mode!

It is possible to read or write individual parameters or multiple/all parameters at once.

The parameters that are read out are saved in the instance data block DB190 in the structures provided. The "Power Transmit" (PT) parameter illustrates this point.

Operand	Symbol	Anzeigeformat	Statuswert	Steuerwert
M 13.0	"ParameterEnable"	BOOL	true	true
M 13.1	"NormalEnable"	BOOL	false	false
M 9.0	"Start"	BOOL	false	true
M 11.0	"Finished"	BOOL	true	
M 11.2	"ParamError"	BOOL	false	
MW 14	"ErrorCMD"	HEX	W#16#0000	
MB 12	"HeadxNumber"	HEX	B#16#01	B#16#01
M 9.1	"ReadWriteParameter"	BOOL	false	
M 9.2	"PowerTransmit"	BOOL	true	true
M 9.3	"TriesAllowed"	BOOL	false	
M 9.4	"Channel Dense Reader"	BOOL	false	
M 9.5	"Protocol Mode"	BOOL	false	
M 9.7	"Q-Value"	BOOL	false	
M 10.0	"Number of Tags"	BOOL	false	
M 10.1	"Sensing Mode"	BOOL	false	
M 10.2	"Memory Bank"	BOOL	false	
M 10.3	"Measure Reflection"	BOOL	false	
M 10.4	"Information_Single"	BOOL	false	
M 10.5	"Reset to Default"	BOOL	false	

Data read out in DB190:

PT.Read.Length := W#16#4

PT.Read.PT1 := W#16#14 (transmission power 1)

PT.Read.PT2 := W#16#64 (transmission power 2)

20	10.0	stat	PT.Read.Length	WORD	W#16#0	W#16#0004
21	12.0	stat	PT.Read.PT1	WORD	W#16#0	W#16#0014
22	14.0	stat	PT.Read.PT2	WORD	W#16#0	W#16#0064
23	16.0	stat	PT.Read.PT3	WORD	W#16#0	W#16#0000
24	18.0	stat	PT.Read.PT4	WORD	W#16#0	W#16#0000
25	20.0	stat	PT.Read.PT5	WORD	W#16#0	W#16#0000
26	22.0	stat	PT.Read.PT6	WORD	W#16#0	W#16#0000
27	24.0	stat	PT.Read.PT7	WORD	W#16#0	W#16#0000
28	26.0	stat	PT.Read.PT8	WORD	W#16#0	W#16#0000
29	28.0	stat	PT.Read.PT9	WORD	W#16#0	W#16#0000
30	30.0	stat	PT.Read.PT10	WORD	W#16#0	W#16#0000

The structure is as follows: abbreviation of the parameter type + read/write + parameter

OB1 includes network 2 for writing the parameters. The required values must be written into the code in network 2. Depending on the inputs set, only the selected parameters are written.

The correct notation and appropriate value ranges can be found in the attached network comment (network 2: init parameters).

If a parameter is configured incorrectly, its parameter type is displayed after the transfer.

	Operand	Symbol	Anzeigeformat	Statuswert	Steuerwert
1	M 13.0	"ParameterEnable"	BOOL	true	true
2	M 13.1	"NormalEnable"	BOOL	false	false
3					
4	M 9.0	"Start"	BOOL	false	true
5	M 11.0	"Finished"	BOOL	true	
6	M 11.2	"ParamError"	BOOL	false	
7	MW 14	"ErrorCMD"	HEX	W#16#5441	
8					
9	MB 12	"HeadxNumber"	HEX	B#16#01	B#16#01
10	M 9.1	"ReadWriteParameter"	BOOL	true	true
11					
12	M 9.2	"PowerTransmit"	BOOL	true	true
13	M 9.3	"TriesAllowed"	BOOL	true	true
14	M 9.4	"Channel Dense Reader"	BOOL	false	
15	M 9.5	"Protocol Mode"	BOOL	true	true
16	M 9.7	"Q-Value"	BOOL	false	
17	M 10.0	"Number of Tags"	BOOL	true	true
18	M 10.1	"Sensing Mode"	BOOL	false	
19	M 10.2	"Memory Bank"	BOOL	false	
20	M 10.3	"Measure Reflection"	BOOL	false	
21	M 10.4	"Information_Single"	BOOL	false	
22	M 10.5	"Reset to Default"	BOOL	false	
23					

The figure shows the following parameters being written to channel 1: "Power Transmit" (PT), "Tries Allowed" (TA), "Protocol Mode" (QV), and "Number of Tags" (NT). The "Tries Allowed" parameter has been configured incorrectly, as identified by the return value of "ErrorCMD" := W#16#5441. The output contains the hexadecimal parameter type of the incorrect parameter ($5441_n = TA_{ASCII}$).

If parameters are to be written, and only parameter types to be read are set on the block (see manual F190), the function block ignores these inputs. It follows the same process when reading parameters.

In the block's default state, all parameters in OB1 are assigned default values.

Example command executions:

6.1 Reset to Default: Channel 1



Note!

In the default state of the read/write head (IUH-F190), multiframe mode is activated. "Reset to Default" loads the default parameters, meaning the operating mode is switched back to multiframe mode!



Define parameters:
HeadNumber := B#16#01
ReadWriteParameter := 1
ResetToDefault := 1

Start execution:
Start := 1 (positive edge)
ParamBusy := 1

Processing complete:
ParamBusy := 0
Finish := 1

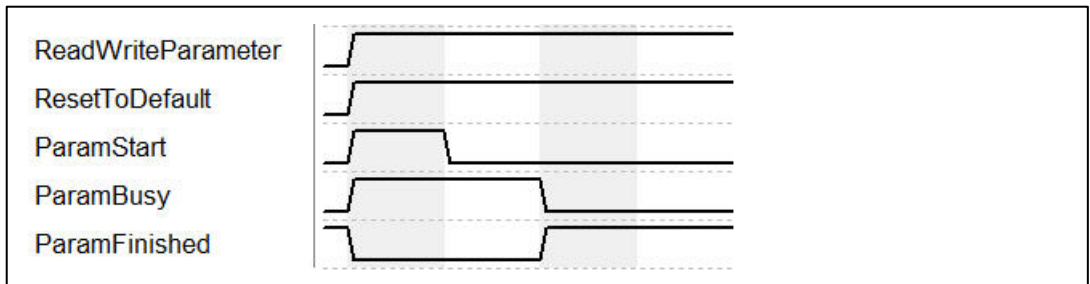

Once the command has been initialized with "ParamStart", "ParamBusy" indicates that command processing is in progress. During this time, "ParamFinished" switches to FALSE. Once the command is complete, "ParamFinished" returns to TRUE.



6.2 PowerTransmit - PT: Channel 1

Reading:

```
Define parameters:
HeadNumber := B#16#01
ReadWriteParameter := 0
PowerTransmit := 1
```

```
Start execution:
Start := 1 (positive edge)
ParamBusy := 1
```

```
Processing complete:
ParamBusy := 0
Finish := 1
Usable data: DB190
```

Write: Parameterize 3 transmission powers

```
Define parameters:
HeadNumber := B#16#01
ReadWriteParameter := 1
PowerTransmit := 1
"DB190_IUHParam".PT.Write.Length := W#16#6
"DB190_IUHParam".PT.Write.PT1 := W#16#30
"DB190_IUHParam".PT.Write.PT2 := W#16#35
"DB190_IUHParam".PT.Write.PT3 := W#16#40
```

```
Start execution:
Start := 1 (positive edge)
ParamBusy := 1
```

```
Processing complete:
ParamBusy := 0
Finish := 1
```

6.3 ChannelDenseReaderMode - CD: Channel 1

Reading:

```
Define parameters:
HeadNumber := B#16#01
ReadWriteParameter := 0
ChannelDenseReaderMode := 1
```

```
Start execution:
Start := 1 (positive edge)
ParamBusy := 1
```

```
Processing complete:
ParamBusy := 0
Finish := 1
Usable data: DB190
```

Write: Channel A & channel B

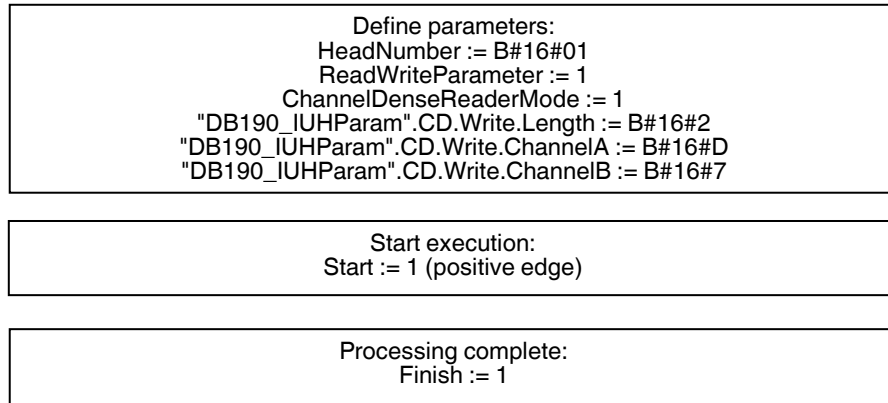

6.4 Read/Write Multiple Parameters: Channel 1

Reading:

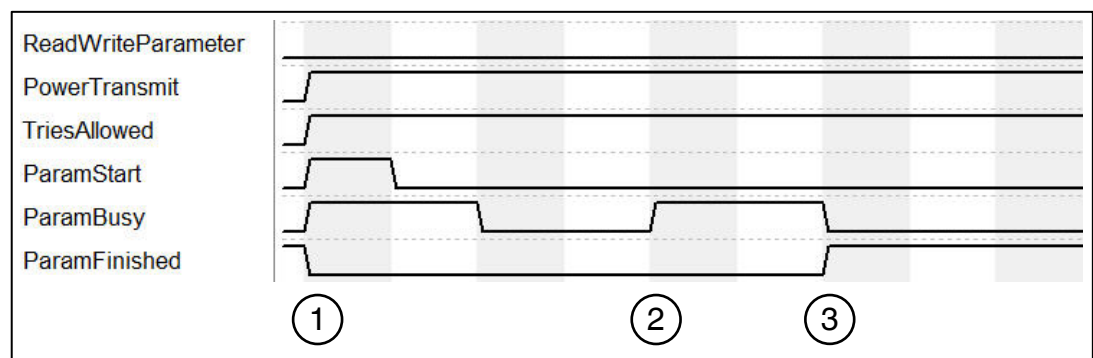
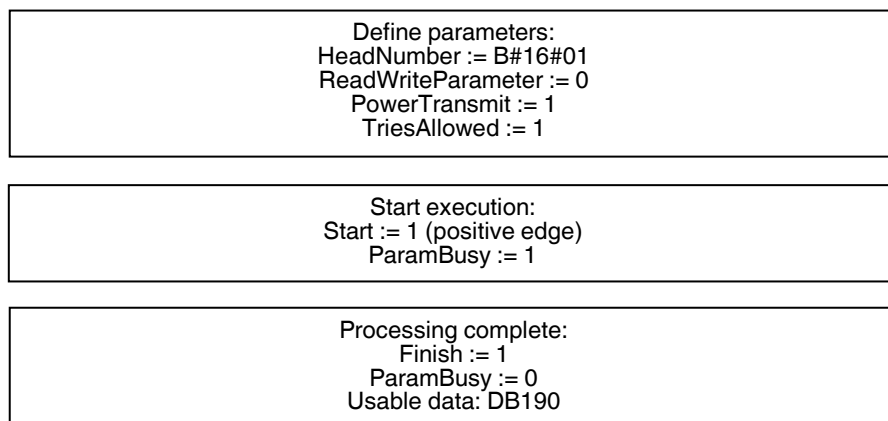

1. Command execution (read) is started with "ParamStart". "ParamFinished" switches to FALSE.
2. "ParamBusy" indicates command processing of "Power Transmit" and "Tries Allowed".
3. Once both parameters are complete, "ParamFinished" returns to TRUE.

Writing:

```

Define parameters:
HeadNumber := B#16#01
ReadWriteParameter := 1
PowerTransmit := 1
TriesAllowed := 1
"DB190_IUHParam".PT.Write.Length := W#16#2
"DB190_IUHParam".PT.Write.PT1 := W#16#30
"DB190_IUHParam".TA.Write.Length := W#16#1
"DB190_IUHParam".TA.Write.TA := B#16#03
    
```

```

Start execution:
Start := 1 (positive edge)
ParamBusy := 1
    
```

```

Processing complete:
ParamBusy := 0
Finish := 1
    
```

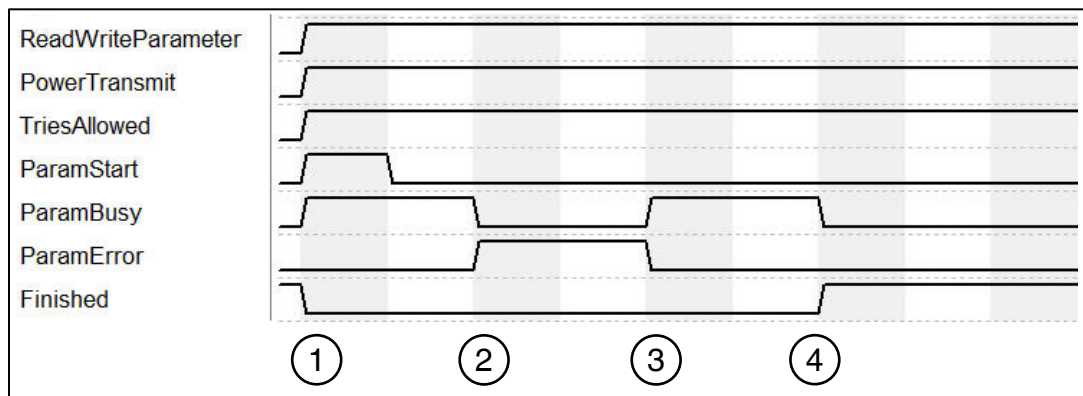

1. Command execution (write) is started with "ParamStart". "ParamFinished" switches to FALSE.
2. "ParamBusy" indicates command processing of "Power Transmit" and "Tries Allowed". "PowerTransmit" parameter configured incorrectly. "ParamError" switches to TRUE.
3. "TriesAllowed" is executed. "ParamError" is reset. "ParamtypeError" output indicates incorrect parameters
4. All commands processed. "ParamFinished" returns to TRUE.

7 **Funktion Block FB32 „Singleframe“**

The function block and corresponding instance data block are accessed as follows:

Call "IDENTControl", "InstDB" (symbolic representation)

or

Call FB32, DB32

For activation to be successful, "NormalEnable" must be active.

This block supports control interfaces with up to two channels.

The following figure shows the function being accessed, as well as the variables requiring parameterization.

```

FB32: CALL "IDENTControl" , "InstDB"
      IC_INPUT_Address :=W#16#200
      IC_OUTPUT_Address :=W#16#200
      Length_IN :=64
      Length_OUT :=64
      Timeout :=T#3S
      Head1DataFixcode :="Head1DataFixcode"
      Head2DataFixcode :="Head2DataFixcode"
      Head3DataFixcode :="Head3DataFixcode"
      Head4DataFixcode :="Head4DataFixcode"
      Head1SingleEnhanced:= "Head1SingleEnhanced"
      Head2SingleEnhanced:= "Head2SingleEnhanced"
      Head3SingleEnhanced:= "Head3SingleEnhanced"
      Head4SingleEnhanced:= "Head4SingleEnhanced"
      Head1SpecialCommand:= "Head1SpecialCommand"
      Head2SpecialCommand:= "Head2SpecialCommand"
      Head3SpecialCommand:= "Head3SpecialCommand"
      Head4SpecialCommand:= "Head4SpecialCommand"
      Head1Read := "Head1Read"
      Head2Read := "Head2Read"
      Head3Read := "Head3Read"
      Head4Read := "Head4Read"
      Head1Write := "Head1Write"
      Head2Write := "Head2Write"
      Head3Write := "Head3Write"
      Head4Write := "Head4Write"
      Head1Quit := "Head1Quit"
      Head2Quit := "Head2Quit"
      Head3Quit := "Head3Quit"
      Head4Quit := "Head4Quit"
      QuitErrorHead1 := "QuitErrorHead1"
      QuitErrorHead2 := "QuitErrorHead2"
      QuitErrorHead3 := "QuitErrorHead3"
      QuitErrorHead4 := "QuitErrorHead4"
      IC_Command_on_Head1:= "IC_Command"
      Head1WordNum :=10
      Head2WordNum :=10
      Head3WordNum :=10
      Head4WordNum :=10
      Head1WordAddress :=W#16#0
      Head2WordAddress :=W#16#0
      Head3WordAddress :=W#16#0
      Head4WordAddress :=W#16#0
      Head1TagType :=W#16#3830
      Head2TagType :=W#16#3830
      Head3TagType :=W#16#3830
      Head4TagType :=W#16#3830
      Head1SpecialFixcode:= "Head1SpecialFixcode"
      Head2SpecialFixcode:= "Head2SpecialFixcode"
      Head3SpecialFixcode:= "Head3SpecialFixcode"
      Head4SpecialFixcode:= "Head4SpecialFixcode"
      Head1Done := "Head1Done"
      Head2Done := "Head2Done"
      Head3Done := "Head3Done"
      Head4Done := "Head4Done"
      Head1NoDataCarrier := "Head1NoDataCarrier"
      Head2NoDataCarrier := "Head2NoDataCarrier"
      Head3NoDataCarrier := "Head3NoDataCarrier"
      Head4NoDataCarrier := "Head4NoDataCarrier"
      Head1Error := "Head1Error"
      Head2Error := "Head2Error"
      Head3Error := "Head3Error"
      Head4Error := "Head4Error"
      Head1Busy := "Head1Busy"
      Head2Busy := "Head2Busy"
      Head3Busy := "Head3Busy"
      Head4Busy := "Head4Busy"
      Head1Status := "Head1Status"
      Head2Status := "Head2Status"
      Head3Status := "Head3Status"
      Head4Status := "Head4Status"
      Head1ReplyCounter := "Head1ReplyCounter"
      Head2ReplyCounter := "Head2ReplyCounter"
      Head3ReplyCounter := "Head3ReplyCounter"
      Head4ReplyCounter := "Head4ReplyCounter"
      InitFinish := "InitFinish"
      SetRestart := "SetRestart"
    
```

Name	Data type	Description
IC_INPUT_Address	WORD	Start address of the control interface in the process image of the inputs (I address)
IC_OUTPUT_Address	WORD	Start address of the control interface in the process image of the outputs (O address)
Length_IN	INT	Length of the input image (length of the PROFIBUS telegram received)
Length_OUT	INT	Length of the output image (length of the PROFIBUS telegram sent)
Timeout	TIME	Timer for monitoring the response time of the control interface
Head1/2/3/4DataFixcode	BOOL	Head 1/2/3/4 access to 0:=Fixcode 1:=data range
Head1/2/3/4SingleEnhanced	BOOL	Execution on head 1/2/3/4 from 0:=Single 1:=Enhanced command
Head1/2/3/4SpecialCommand	BOOL	Execution of a special command on head 1/2/3/4 (positive edge); define command parameters in advance in structure Head_X.SpecialCommand; usable data received is located in the structure Head_X.InData
Head1/2/3/4Read	BOOL	Execution of read command on head 1/2/3/4 (positive edge); define command parameters HeadXWordNum and HeadXWordaddress; usable data received is located in the structure Head_X.InData
Head1/2/3/4Write	BOOL	Execution of write command on head 1/2/3/4 (positive edge); define command parameters HeadXWordNum and HeadXWordaddress; define data to be written in advance in the structure Head_X.OutData.DW1...15
Head1/2/3/4Quit	BOOL	Execution of quit command on head 1/2/3/4 to cancel an enhanced command (positive edge)
QuitErrorHead1/2/3/4	BOOL	Execution of error routine on head 1/2/3/4 (positive edge)
IC_Command_Head1	BOOL	Execution of a special command on the control interface (positive edge); command is sent to channel 0; define command parameters in advance in the structure Head_1.SpecialCommand; usable data received is located in the structure Head_1.InData
Head1/2/3/4WordNum	INT	Number of data blocks activated on head 1/2/3/4
Head1/2/3/4WordAddress	WORD	Start address of the memory activated on channel 1/2/3/4 on read/write tag
Head1/2/3/4TagType	WORD	Tag type channel 1/2/3/4 (tag type table)
Head1/2/3/4SpecialFixcode	BOOL	Head 1/2/3/4 access to 1:=SpecialFixcode (EPC)
Head1/2/3/4Done	BOOL	New data present (enhanced) or command complete (single) on channel 1/2/3/4 (positive edge)
Head1/2/3/4NoDataCarrier	BOOL	No read/write tag present at execution time of a command on channel 1/2/3/4
Head1/2/3/4Error	BOOL	Error occurred on channel 1/2/3/4 (positive edge)
Head1/2/3/4Busy	BOOL	Command is processed on channel 1/2/3/4
Head1/2/3/4Status	BYTE	Channel 1/2/3/4 status value
Head1/2/3/4ReplyCounter	BYTE	Channel 1/2/3/4 reply counter value

2014-02

InitFinish	BOOL	Initialization complete (positive edge)
SetRestart	BOOL	Execution of control interface initialization (positive edge)

Example of setting communication parameters:

The communication module "64 In / 64 Out Bytes" has been selected in the hardware configuration. The process image of the inputs (I address) starts at address 512, ends after address 575, and has a length of 64 bytes. The process image of the outputs (O address) starts at address 512 and ends after address 575. This results in the following parameterization for the function block:

```

IC_INPUT_Address      :=W#16#200
IC_OUTPUT_Address     :=W#16#200
Length_IN             :=64
Length_OUT            :=64
    
```

Note:

When selecting a communication module for the pure read operation (e.g., "64 In / 4 Out Bytes"), the source address ("IC_OUTPUT_Address") must be completely within the process image. For CPUs in the S7-300 Series, the O range has a length of 0 to 256. The S7-400 Series has a process image for the outputs with a length of 0 to 512.

Please note the maximum telegram length for the CPU used. CPU S7-315-2DP is designed for a maximum telegram length of 32 bytes. CPUs in the S7-400 Series are designed for a telegram length of 64 bytes.

8 Error or Device Diagnostics

Most errors occur during commissioning of the block (initialization). If the InitFinish bit is not automatically set after the start of initialization (positive edge on SetRestart), an error has occurred during initialization. The primary cause is different parameterization of the hardware configuration within the Simatic hardware manager and the parameterization of the I/O range or the telegram length on the function block. The set tag type (Head1/2/3/4 TagType) must also be checked.

There is a further potential for errors when executing commands. If an error occurs in these cases, then the Head1/2/3/4Error bit is set. A diagnosis can then be carried out using the error table below. The cause of the errors may be incorrect command parameters (particularly in the case of a special command) or an incorrectly set tag type. An incorrect command parameter is indicated by the status value (Head1/2/3/4Status) 0x04.

Name	Data type	Description	Remedy
Head1/2/3/4Error	BOOL	Error on head 1(2)	
Head_1/2/3/4.InvalidResponse	BOOL	Sent and received command telegram are not identical	Check the Data Hold Time. Check the I/O configuration.
Head_1/2/3/4.TimeoutOccured	BOOL	Timer for communication monitoring has expired. Slave has not sent a response in the time frame.	Increase the variable timeout for long cycle times.
Head_1/2/3/4.Error_SFC_14	BOOL	Error reading in the data from the process image	Check the variables Head_1/2/3/4.Ret_Val_SFC14. Check the parameterized I/O address and telegram length
Head_1/2/3/4.Error_SFC_15	BOOL	Error writing the data to the process image	Check the variables Head_1/2/3/4.Ret_Val_SFC15. Check the parameterized I/O address and telegram length
Head_1/2/3/4.Ret_Val_SFC14	WORD	Error code during execution of SFC14	W#16#8090 W#16#80B1 Check the parameterized I/O address and telegram length (additional information on SFC14 system help)
Head_1(2).Ret_Val_SFC15	INT	Error code during execution of SFC15 (conversion to HEX format required)	W#16#8090 W#16#80B1 Check the parameterized I/O address and telegram length (additional information on SFC15 system help)
Head1(2)Status	BYTE	Status of the data last read in on channel 1(2)	See table of status values
Memory.InData.Status	BYTE	Status of the data telegram last read in	See table of status values

9 Examples Command Execution

9.1 Initialization: (with tag type IUC72)

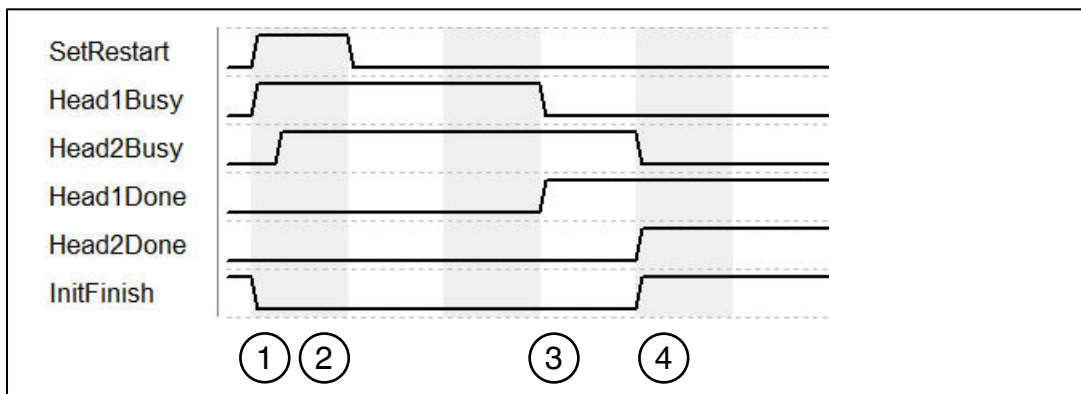
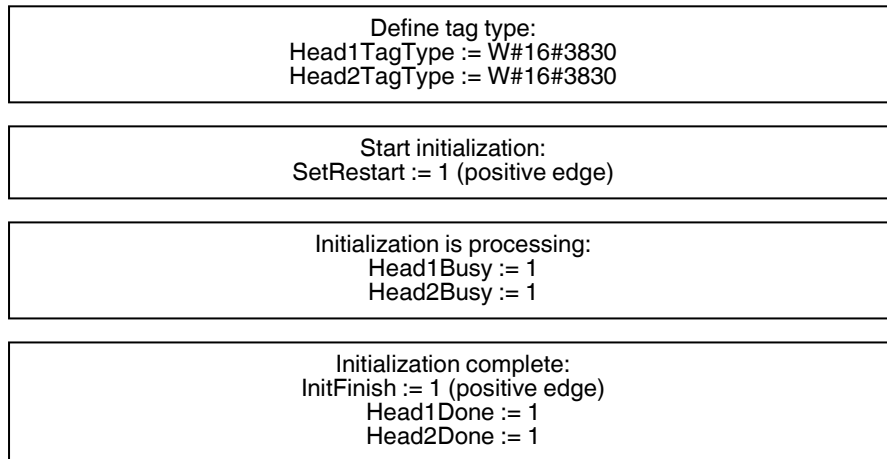

1. "SetRestart" triggers initialization routine. Initialization is completed on head 1 ("Head1Busy").
2. Head 2 is initialized ("Head2Busy") immediately after head 1 has sent confirmation that it must be initialized.
3. Initialization on head 1 complete ("Head1Done").
4. "Head1Done" and "Head2Done" switch to TRUE. Initialization complete; "InitFinish" switches to TRUE.

*For a clearer overview, the restart routine is shown only on channel 1 and channel 2. The routine is the same for channels 3 and 4.

9.2 Single Read Fixcode: (Head 1)

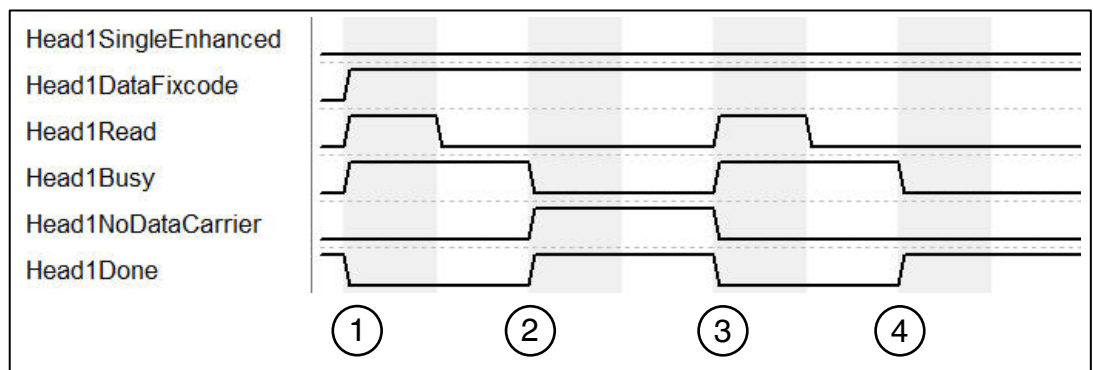
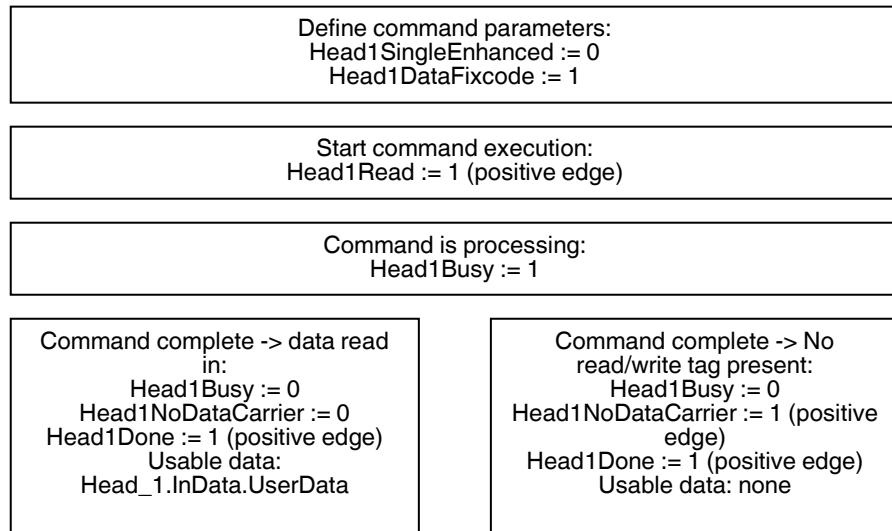

1. "Head1SingleEnhanced" is zero-active in order to initialize a single command. "Head1DataFixcode" is TRUE in order to access the Fixcode/TID. Single Read Fixcode is started by "Head1Read" switching to TRUE. "Head1Busy" switches to TRUE; at the same time, "Head1Done" switches to FALSE.
2. Once the command is executed, "Head1Busy" is zero-active again and "Head1Done" returns to TRUE. At the time of the reading, there was no read/write tag in the detection range and "Head1NoDataCarrier" switches to TRUE.
3. Single Read Fixcode is started by "Head1Read" switching to TRUE. "Head1Busy" switches to TRUE; at the same time, "Head1Done" switches to FALSE. "Head1NoDataCarrier" switches to FALSE.
4. Once the command is executed, "Head1Busy" is zero-active again and "Head1Done" returns to TRUE. At the time of the reading, there was a read/write tag in the detection range and "Head1NoDataCarrier" remains zero-active.

9.3 Enhanced Read Fixcode: (Head 1)

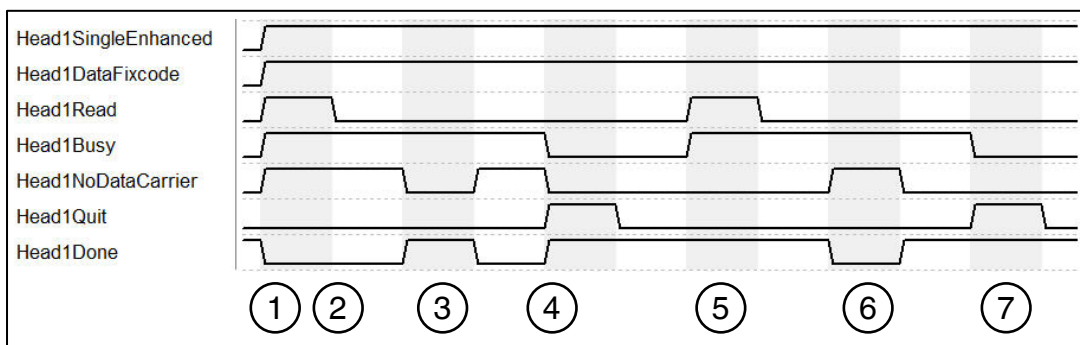
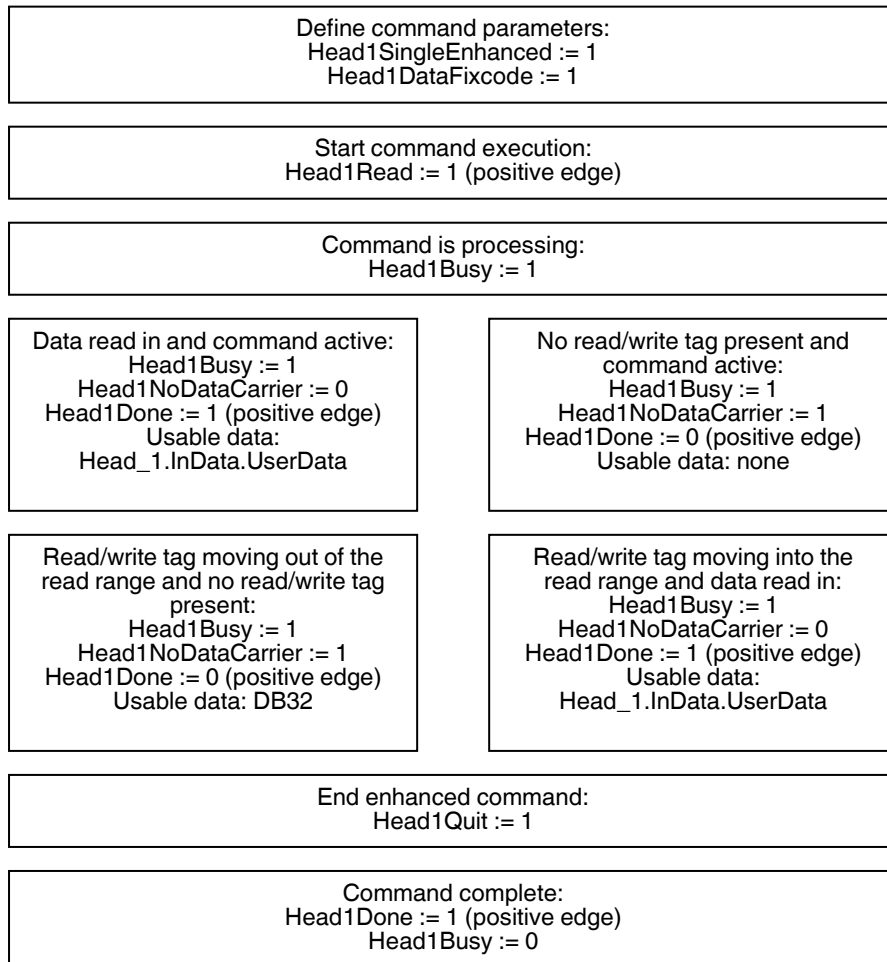

1. "Head1SingleEnhanced" is TRUE in order to initialize an enhanced command. "Head1DataFixcode" is TRUE in order to access the Fixcode/TID. Enhanced Read Fixcode is started, "Head1Read" is TRUE. "Head1Busy" switches to TRUE; at the same time, "Head1Done" switches to FALSE.
2. "Head1NoDataCarrier" is TRUE as there is no read/write tag in range at this time.
3. Read/write tag enters detection range. "Head1NoDataCarrier" switches to FALSE, "Head1Done" switches to TRUE. The read/write tag exits the detection range shortly afterward.
4. "Head1Quit" cancels continuous reading. "Head1Busy" switches to FALSE, "Head1Done" is now TRUE.

5. New Enhanced Read Fixcode command started. Read/write tag detected; "Head1NoDataCarrier" is FALSE, "Head1Done" is active.
6. "Head1Done" is FALSE as there is no read/write tag in the detection range; "Head1NoDataCarrier" is TRUE. Read/write tag enters the detection range again shortly afterward.
7. Cancel command with "Head1Quit"

9.4 Single Read Words: (Head 1; 15 Blocks from Address 0)

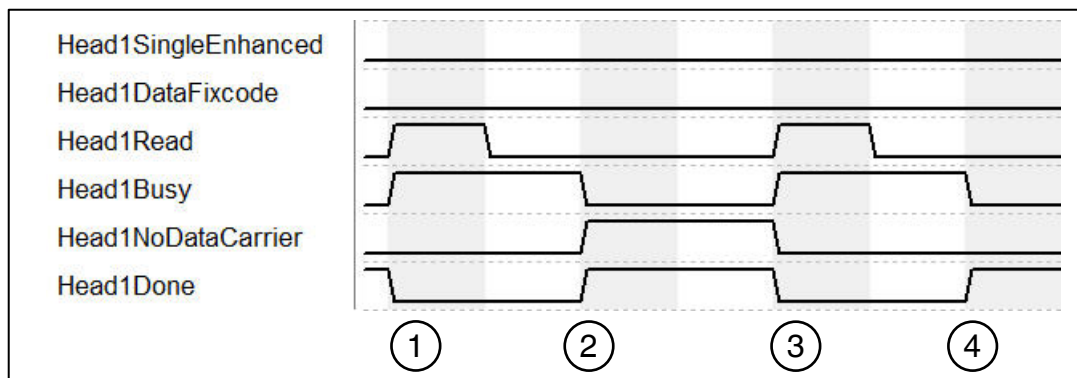
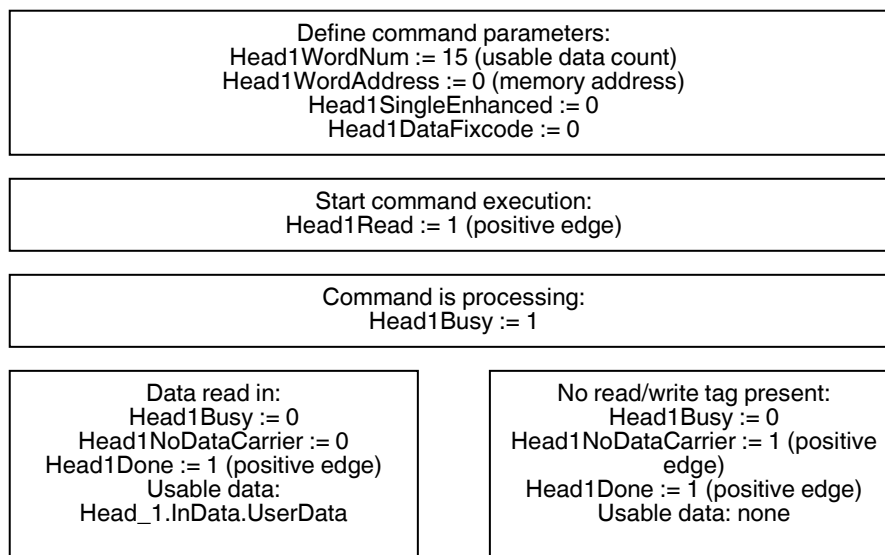

1. "Head1SingleEnhanced" is zero-active in order to initialize a single command. "Head1DataFixcode" is FALSE in order to access words/user data. Single Read Words is started by "Head1Read" switching to TRUE. "Head1Busy" switches to TRUE; at the same time, "Head1Done" switches to FALSE.
2. Once the command is executed, "Head1Busy" is zero-active again and "Head1Done" returns to TRUE. At the time of the reading, there was no read/write tag in the detection range and "Head1NoDataCarrier" switches to TRUE.
3. Single Read Words is started by "Head1Read" switching to TRUE. "Head1Busy" switches to TRUE; at the same time, "Head1Done" switches to FALSE. "Head1NoDataCarrier" switches to FALSE.
4. Once the command is executed, "Head1Busy" is zero-active again and "Head1Done" returns to TRUE. At the time of the reading, there was a read/write tag in the detection range and "Head1NoDataCarrier" remains zero-active.

9.5 Enhanced Read Words: (Head 1; 15 Blocks from Address 0)

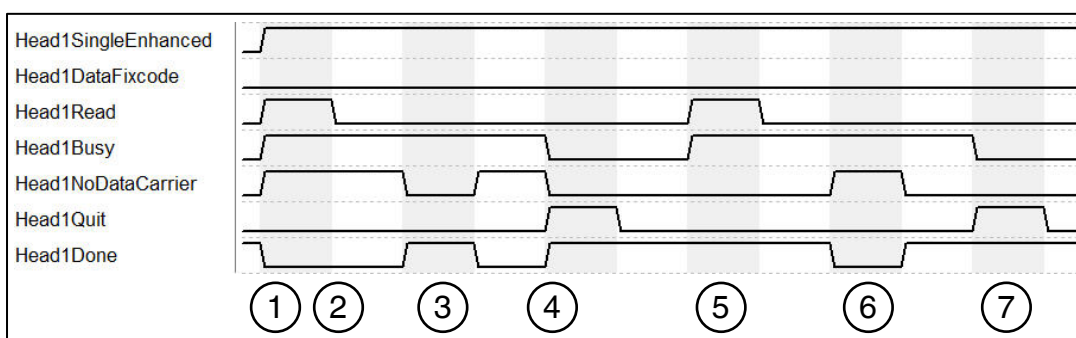
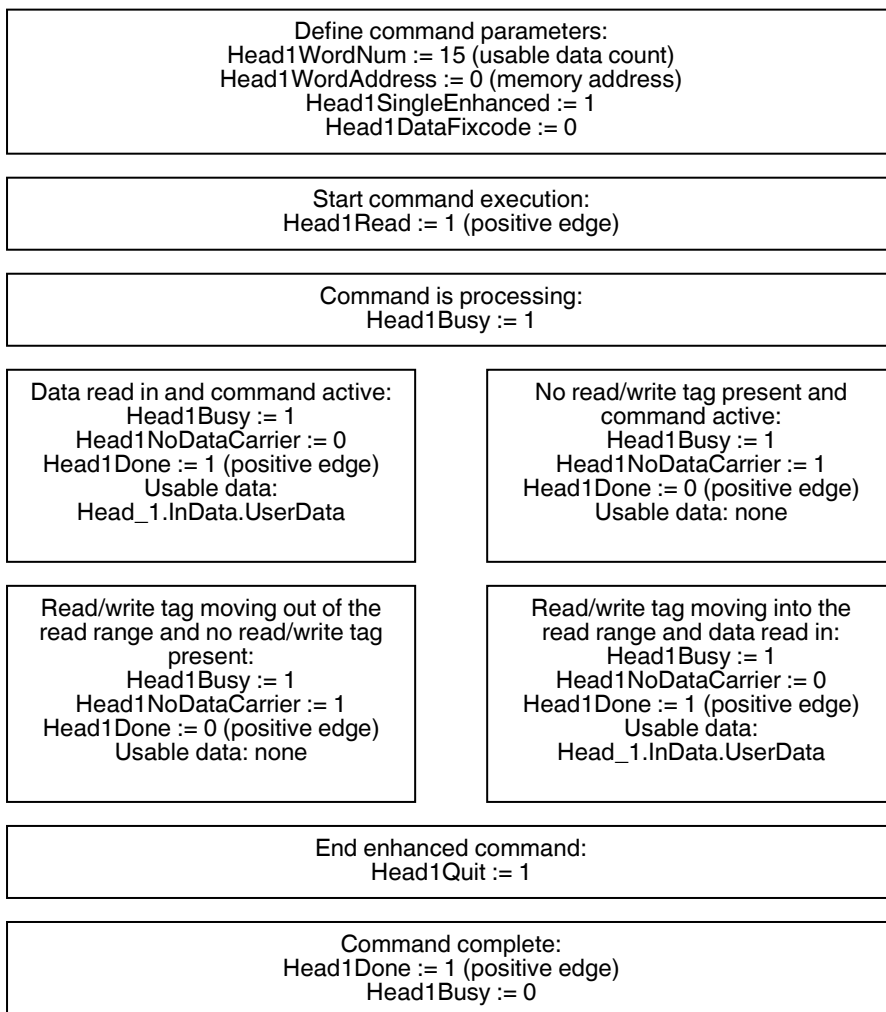

1. "Head1SingleEnhanced" is TRUE in order to initialize an enhanced command. "Head1DataFixcode" is FALSE in order to access words/user data. Enhanced Read Words is started, "Head1Read" is TRUE. "Head1Busy" switches to TRUE; at the same time, "Head1Done" switches to FALSE.
2. "Head1NoDataCarrier" is TRUE as there is no read/write tag in range at this time.
3. Read/write tag enters detection range. "Head1NoDataCarrier" switches to FALSE, "Head1Done" switches to TRUE. The read/write tag exits the detection range shortly afterward.

4. "Head1Quit" cancels continuous reading. "Head1Busy" switches to FALSE, "Head1Done" is now TRUE.
5. New Enhanced Read Words command started. Read/write tag detected; "Head1NoDataCarrier" is FALSE, "Head1Done" is active.
6. "Head1Done" is FALSE as there is no read/write tag in the detection range; "Head1NoDataCarrier" is TRUE. Read/write tag enters the detection range again shortly afterward.
7. Cancel command with "Head1Quit"

9.6 Single Read SpecialFixcode: (Head 1)

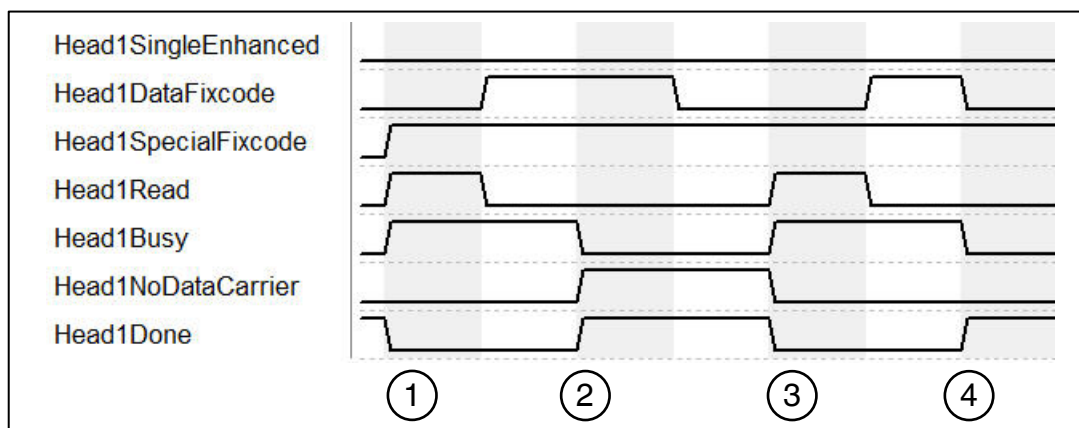
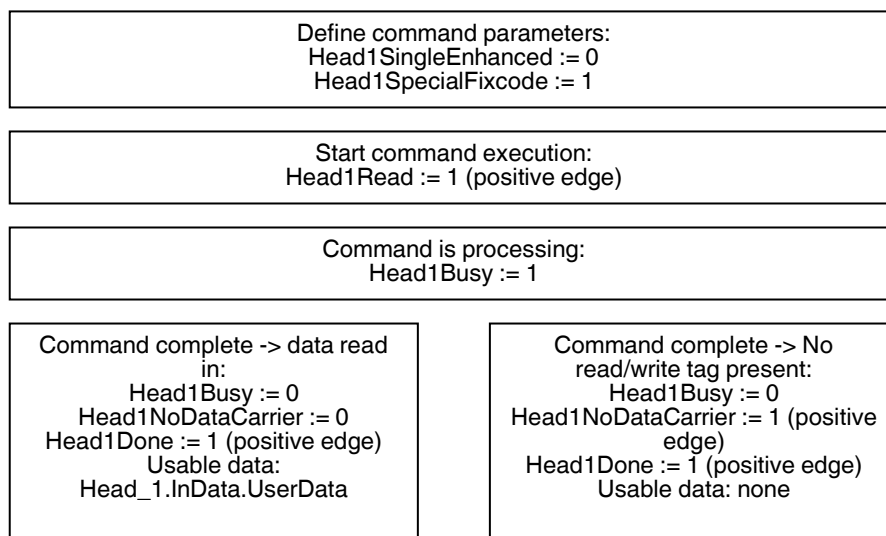

1. "Head1SingleEnhanced" is zero-active in order to initialize a single command. "Head1DataFixcode" is irrelevant as "Head1SpecialFixcode" has higher priority than Words or Fixcode (i.e., as soon as "Head1SpecialFixcode" is TRUE, "Head1DataFixcode" becomes invalid). "Head1DataFixcode" is TRUE in order to access the SpecialFixcode/EPC. Single Read SpecialFixcode is started by "Head1Read" switching to TRUE. "Head1Busy" switches to TRUE; at the same time, "Head1Done" switches to FALSE.
2. Once the command is executed, "Head1Busy" is zero-active again and "Head1Done" returns to TRUE. At the time of the reading, there was no read/write tag in the detection range and "Head1NoDataCarrier" switches to TRUE.

3. Single Read SpecialFixcode is started by "Head1Read" switching to TRUE. "Head1Busy" switches to TRUE; at the same time, "Head1Done" switches to FALSE. "Head1NoDataCarrier" switches to FALSE.
4. Once the command is executed, "Head1Busy" is zero-active again and "Head1Done" returns to TRUE. At the time of the reading, there was a read/write tag in the detection range and "Head1NoDataCarrier" remains zero-active.

9.7 Enhanced Read SpecialFixcode: (Head 1)

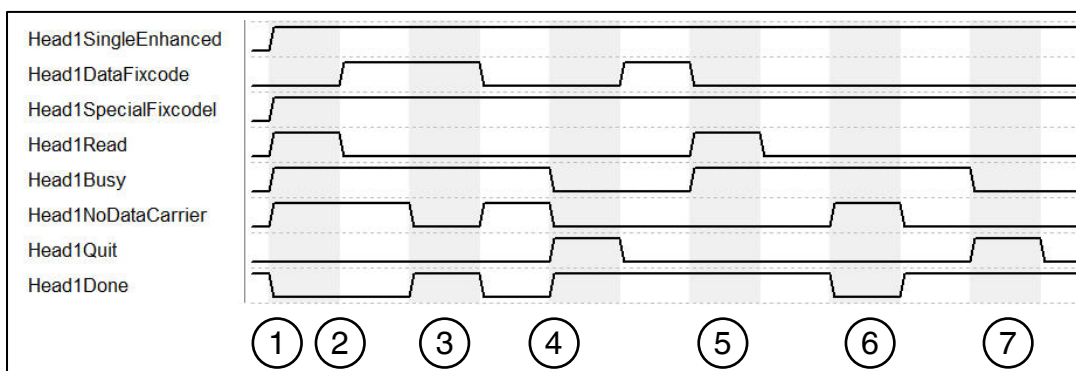
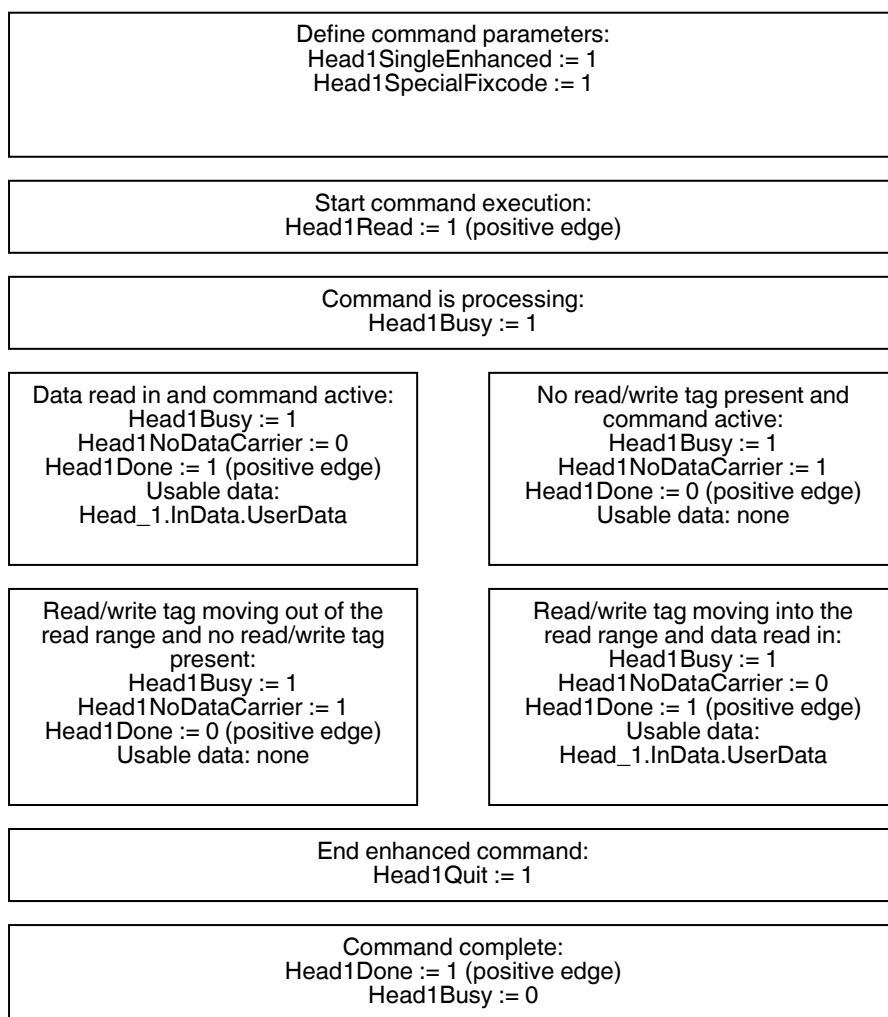

1. "Head1SingleEnhanced" is TRUE in order to initialize an enhanced command. "Head1DataFixcode" is irrelevant as "Head1SpecialFixcode" has higher priority than

Words or Fixcode (i.e., as soon as "Head1SpecialFixcode" is TRUE, "Head1DataFixcode" becomes invalid). "Head1SpecialFixcode" is TRUE in order to access the SpecialFixcode/EPC. Enhanced Read SpecialFixcode is started, "Head1Read" is TRUE. "Head1Busy" switches to TRUE; at the same time, "Head1Done" switches to FALSE.

2. "Head1NoDataCarrier" is TRUE as there is no read/write tag in range at this time.
3. Read/write tag enters detection range. "Head1NoDataCarrier" switches to FALSE, "Head1Done" switches to TRUE. The read/write tag exits the detection range shortly afterward.
4. "Head1Quit" cancels continuous reading. "Head1Busy" switches to FALSE, "Head1Done" is now TRUE.
5. New Enhanced Read SpecialFixcode command started. Read/write tag detected; "Head1NoDataCarrier" is FALSE, "Head1Done" is active.
6. "Head1Done" is FALSE as there is no read/write tag in the detection range; "Head1NoDataCarrier" is TRUE. Read/write tag enters the detection range again shortly afterward.
7. Cancel command with "Head1Quit"

9.8 Single Write Words: (Head 1; 15 Blocks from Address 0)

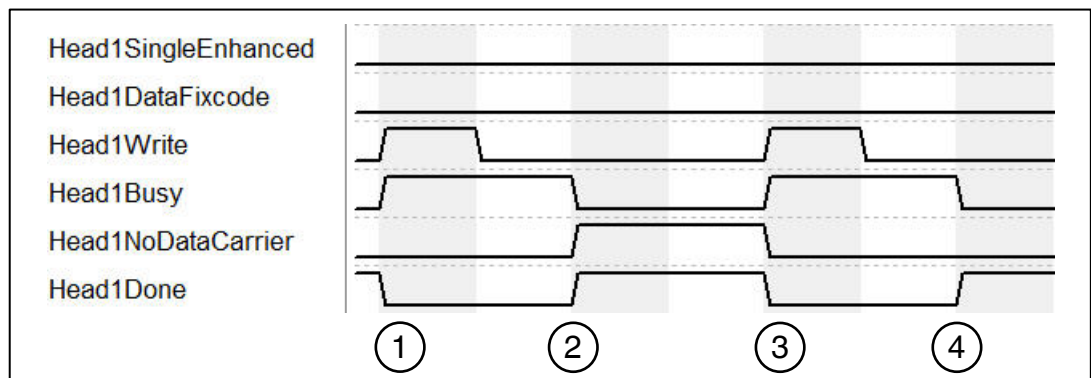
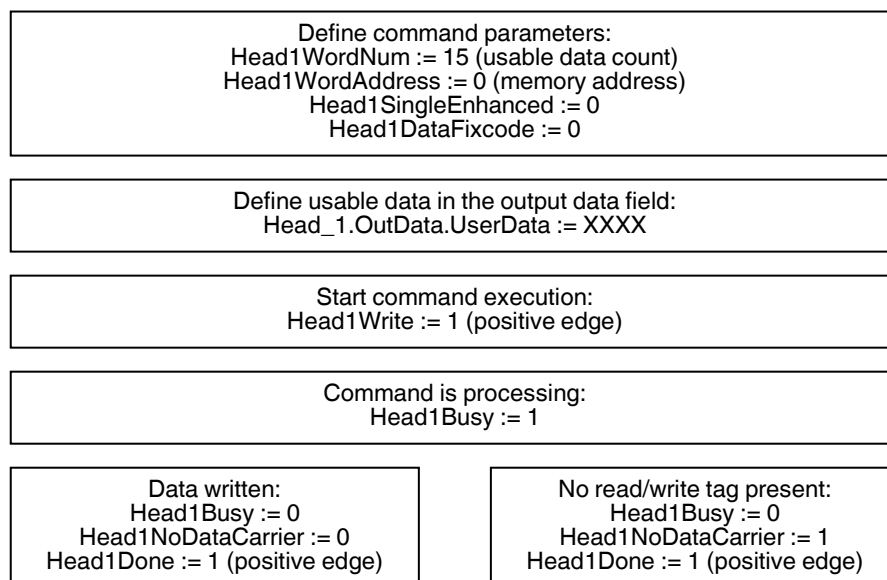

1. "Head1SingleEnhanced" is zero-active in order to initialize a single command. "Head1DataFixcode" is FALSE in order to access Words/User Data. Single Write

Words is started by "Head1Write" switching to TRUE. "Head1Busy" switches to TRUE; at the same time, "Head1Done" switches to FALSE.

2. Once the command is executed, "Head1Busy" is zero-active again and "Head1Done" returns to TRUE. At the time of the writing, there was no read/write tag in the detection range and "Head1NoDataCarrier" switches to TRUE.
3. Single Write Words is started by "Head1Write" switching to TRUE. "Head1Busy" switches to TRUE; at the same time, "Head1Done" switches to FALSE. "Head1NoDataCarrier" switches to FALSE.
4. Once the command is executed, "Head1Busy" is zero-active again and "Head1Done" returns to TRUE. At the time of writing, there was a read/write tag in the detection range and "Head1NoDataCarrier" remains zero-active.

9.9 Enhanced Write Words: (Head 1; 15 Blocks from Address 0)

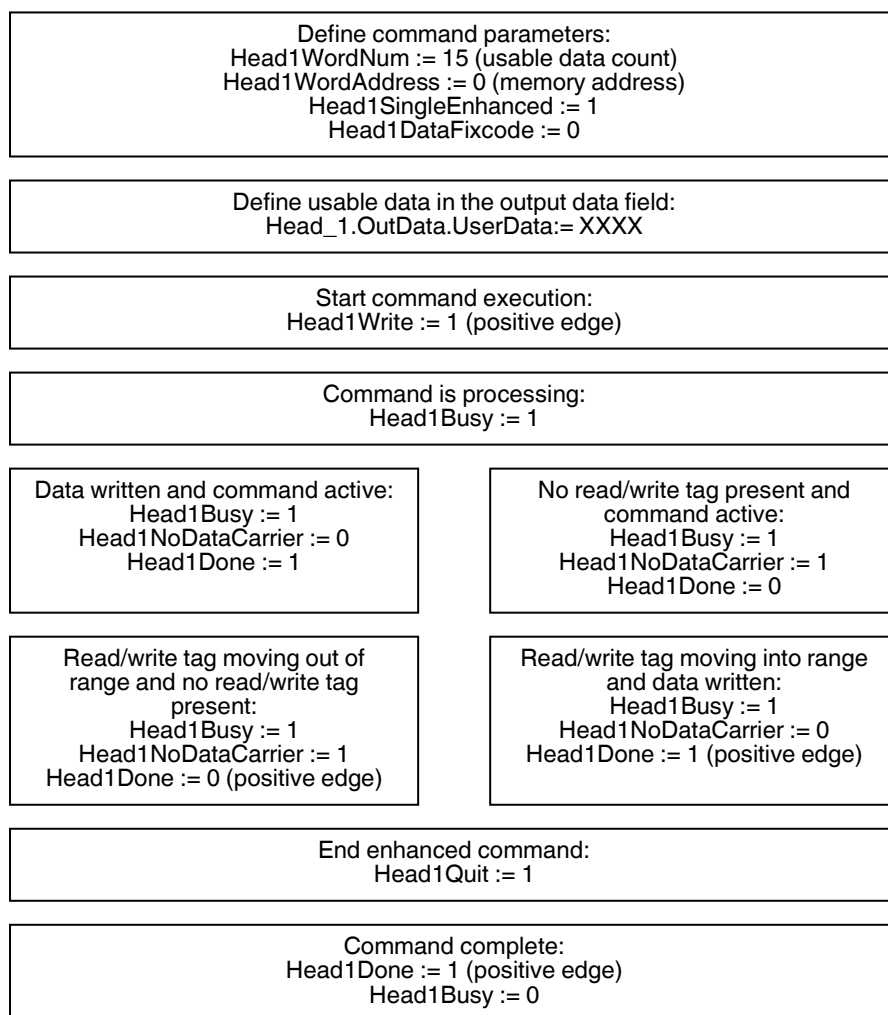

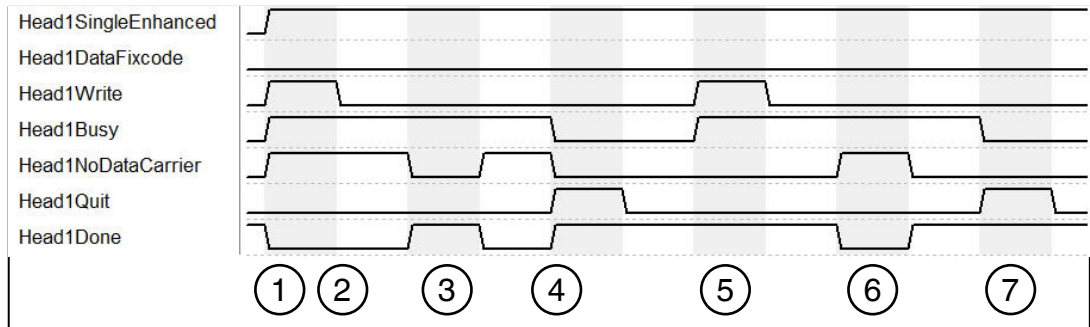

1. "Head1SingleEnhanced" is TRUE in order to initialize an enhanced command. "Head1DataFixcode" is FALSE in order to access Words/User Data. Enhanced Write Words is started, "Head1Write" is TRUE. "Head1Busy" switches to TRUE; at the same time, "Head1Done" switches to FALSE.
2. "Head1NoDataCarrier" is TRUE as there is no read/write tag in range at this time.
3. Read/write tag enters detection range. "Head1NoDataCarrier" switches to FALSE, "Head1Done" switches to TRUE. The read/write tag exits the detection range shortly afterward.
4. "Head1Quit" cancels continuous writing. "Head1Busy" switches to FALSE, "Head1Done" is now TRUE.
5. New Enhanced Write Words command started. Read/write tag detected; "Head1NoDataCarrier" is FALSE, "Head1Done" is active.
6. "Head1Done" is FALSE as there is no read/write tag in the detection range; "Head1NoDataCarrier" is TRUE. Read/write tag enters the detection range again shortly afterward.
7. Cancel command with "Head1Quit"

9.10 Single Write Fixcode: (Head 1; IPC11)

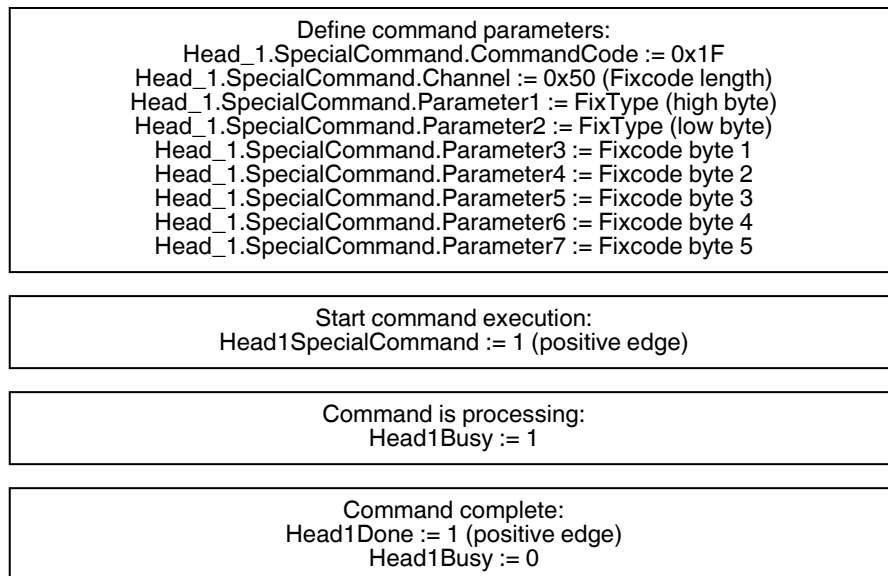

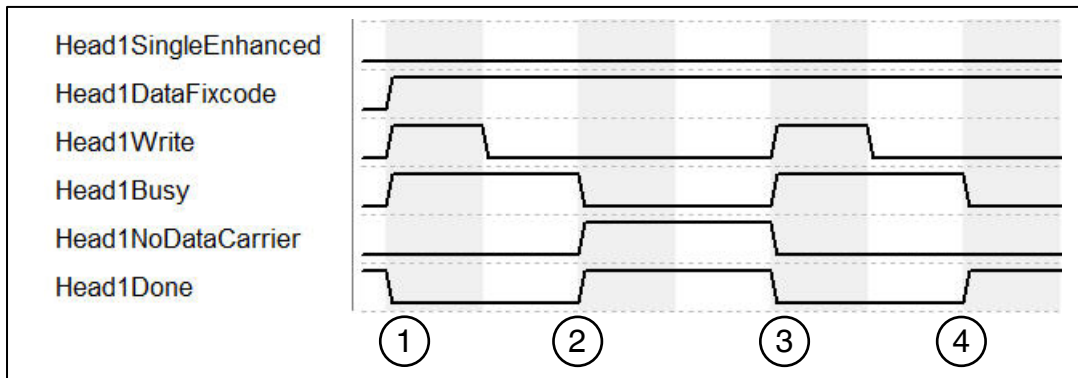

1. "Head1SingleEnhanced" is zero-active in order to initialize a single command. "Head1DataFixcode" is TRUE in order to access the Fixcode/TID. Single Write Fixcode is started by "Head1Write" switching to TRUE. "Head1Busy" switches to TRUE; at the same time, "Head1Done" switches to FALSE.
2. Once the command is executed, "Head1Busy" is zero-active again and "Head1Done" returns to TRUE. At the time of the writing, there was no read/write tag in the detection range and "Head1NoDataCarrier" switches to TRUE.
3. Single Write Fixcode is started by "Head1Write" switching to TRUE. "Head1Busy" switches to TRUE; at the same time, "Head1Done" switches to FALSE. "Head1NoDataCarrier" switches to FALSE.
4. Once the command is executed, "Head1Busy" is zero-active again and "Head1Done" returns to TRUE. At the time of writing, there was a read/write tag in the detection range and "Head1NoDataCarrier" remains zero-active.

9.11 Single Write SpecialFixcode: (Head 1)

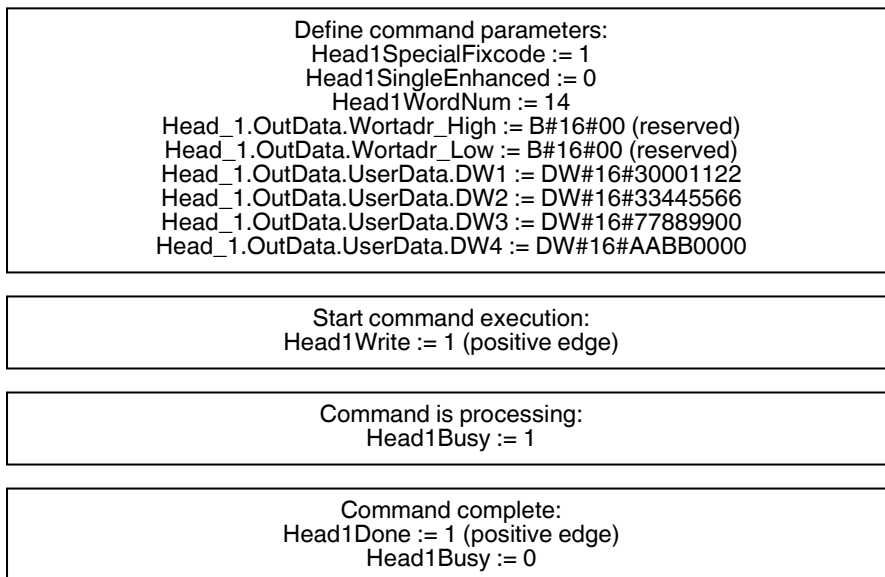

Note the correct notation of the PC (in accordance with EPC Gen 2 [ISO/IEC 18000-63])! The read/write tag could be rendered unusable if the configuration is incorrect!

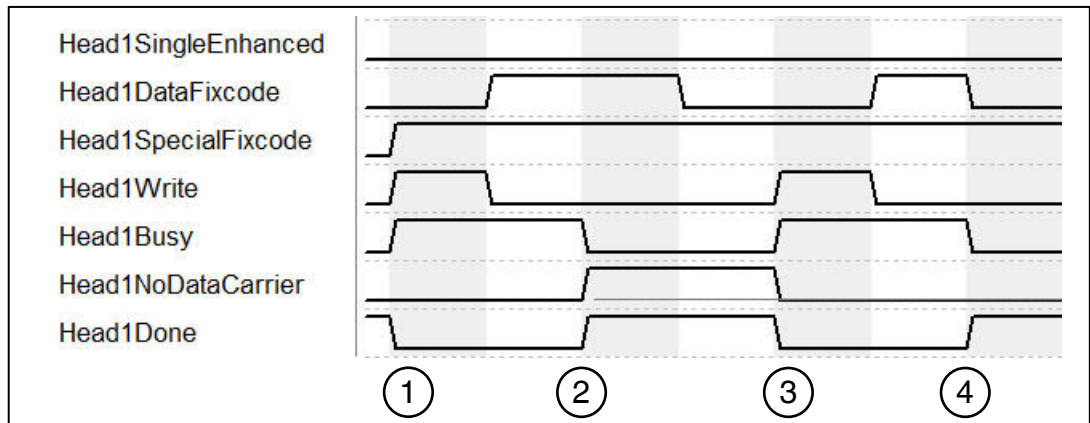

1. "Head1SingleEnhanced" is zero-active in order to initialize a single command. "Head1DataFixcode" is irrelevant as "Head1SpecialFixcode" has higher priority than Words or Fixcode (i.e., as soon as "Head1SpecialFixcode" is TRUE, "Head1DataFixcode" becomes invalid). "Head1DataFixcode" is TRUE in order to access the SpecialFixcode/EPC. Single Write SpecialFixcode is started by "Head1Write" switching to TRUE. "Head1Busy" switches to TRUE; at the same time, "Head1Done" switches to FALSE.
2. Once the command is executed, "Head1Busy" is zero-active again and "Head1Done" returns to TRUE. At the time of the writing, there was no read/write tag in the detection range and "Head1NoDataCarrier" switches to TRUE.
3. Single Write SpecialFixcode is started by "Head1Write" switching to TRUE. "Head1Busy" switches to TRUE; at the same time, "Head1Done" switches to FALSE. "Head1NoDataCarrier" switches to FALSE.
4. Once the command is executed, "Head1Busy" is zero-active again and "Head1Done" returns to TRUE. At the time of writing, there was a read/write tag in the detection range and "Head1NoDataCarrier" remains zero-active.

9.12 Error Handling: (Head 1)

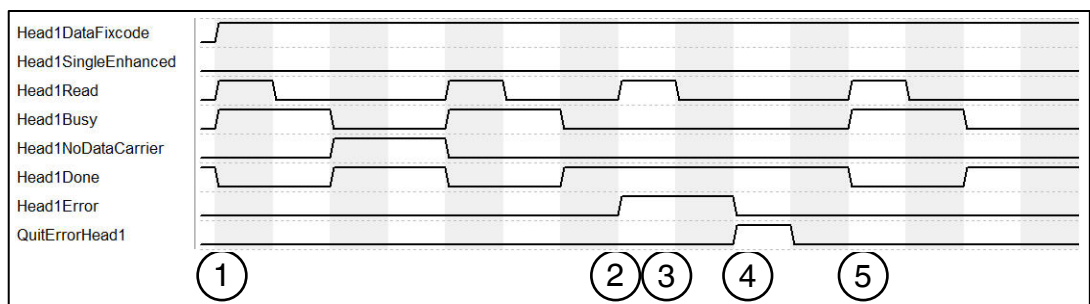

1. Random command execution started.
2. An error occurred after the second read command; "Head1Error" is TRUE.
3. Errors disable the entire block. The block ignores subsequent commands. "Head1Read" has no effect while "Head1Error" is TRUE.
4. "QuitErrorHead1" acknowledges the error and enables the block.
5. Commands can once again be executed normally.

9.13 Command List (Prefetch): (Head 1)

Multiple commands can be processed in sequence using the command list. The command list must first be opened. The commands to be executed will then be transferred to the list and, when completed, the command list will be closed. The list is processed as soon as it is

activated in single or enhanced mode. The command lists are stored in a volatile state. The special command is used to open, close, and activate the command lists, as well as transfer the commands to be executed.

Open the command list:.

```
Define command parameters: Open the command list
Head_1.SpecialCommand.CommandCode := 0xAC
Head_1.SpecialCommand.Channel := 0x00
Head_1.SpecialCommand.Parameter1 := 0x00 (ListNo)
Head_1.SpecialCommand.Parameter2 := 0x01 (ListModus)
```

```
Start command execution: Command transfer
Head1SpecialCommand := 1 (positive edge)
```

```
Command processing: Transfer in progress
Head1Busy := 1
```

```
Command complete: Transfer complete
Head1Done := 1 (positive edge)
Head1Busy := 0
```

After opening the command list, the commands to be executed are transferred to the control interface by the special command. The Enhanced Read Fixcode command is then parameterized, followed by the Enhanced Read Words command.

Command 1: Enhanced Read Fixcode head 1

```
Define command parameters: Enhanced Read Fixcode
Head_1.SpecialCommand.CommandCode := 0x01
Head_1.SpecialCommand.Channel := 0x00
```

```
Start command execution: Command transfer
Head1SpecialCommand := 1 (positive edge)
```

```
Command processing: Transfer in progress
Head1Busy := 1
```

```
Command complete: Transfer complete
Head1Done := 1 (positive edge)
Head1Busy := 0
```

Command 2: Enhanced Read Words

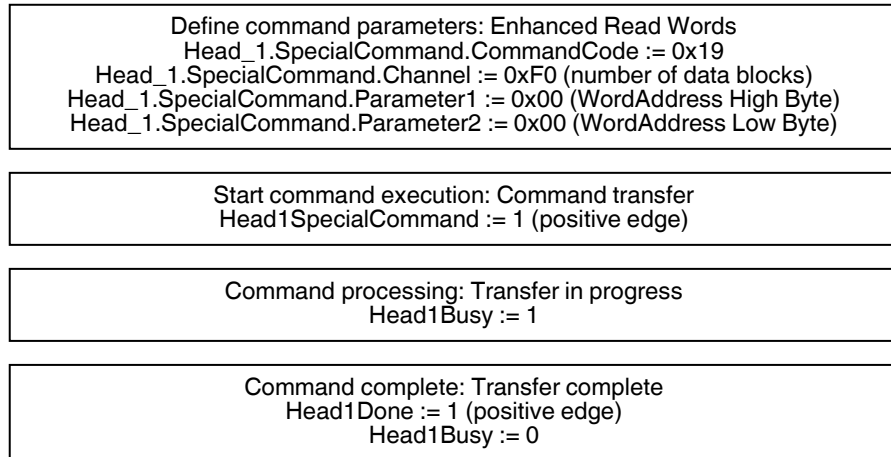

The number of parameterized commands can be increased to a maximum of 10.
Parameterization is completed by closing the command list.

Close the command list:

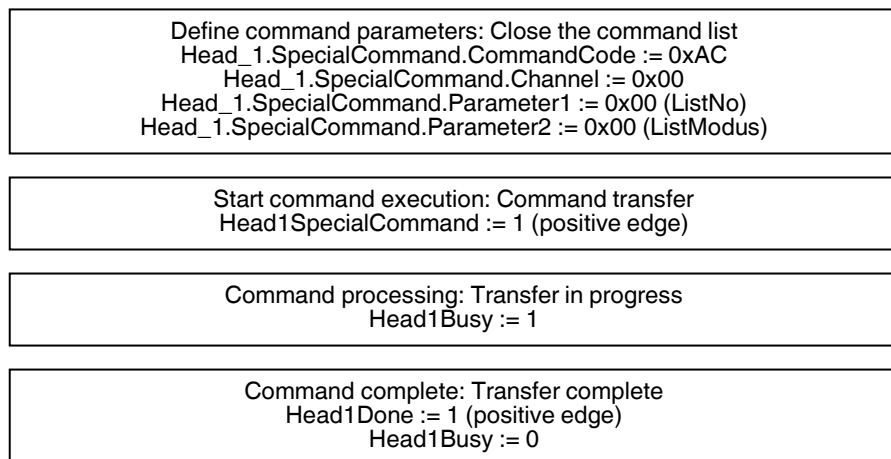

The command list is executed as soon as it is activated. The command list can be activated in single or enhanced mode.

Activation in single mode:

```
Define command parameters: Activate single mode
Head_1.SpecialCommand.CommandCode := 0xAC
Head_1.SpecialCommand.Channel := 0x00
Head_1.SpecialCommand.Parameter1 := 0x00 (ListNo)
Head_1.SpecialCommand.Parameter2 := 0x02 (ListModus)
```

```
Start command execution: Command transfer
Head1SpecialCommand := 1 (positive edge)
```

```
Command processing: Transfer in progress
Head1Busy := 1
```

```
Command complete: Transfer complete
Head1Done := 1 (positive edge)
Head1Busy := 0
```

Once the command list is activated, the commands are processed in sequence. The usable data that has been read in is located in the data structure Head_1.InData.UserData. If there is a read/write tag in the detection range, the status (Head1Status) of all response telegrams has the value 0x00. The execution counter (Head1ReplyCounter) can be used to distinguish between the various successive response telegrams. When a new response telegram is received, the value of this variable in relation to the previous telegram has changed. Once a run through the command list is completed, a response telegram is received with the status (Head1Status) 0x0F. When the command list is activated in single mode, one run through the command list is completed. Following receipt of the last telegram (Head1Status = 0x0F), execution is stopped automatically. When enhanced mode is activated, the execution of the command list starts again from the beginning following receipt of the last telegram.

10 Table of Read/Write Tags

Name	TagType	Access	Fixcode	Data	WordAddress	Frequency
IPC02	W#16#3032	Read Fixcode	5 Byte	-	-	125kHz
IPC03	W#16#3033	Read Fixcode Read Words Write Words	4 Byte	116 Byte	0000...001C	125kHz
IPC11	W#16#3131	Read Fixcode Write Fixcode	5 Byte	-	-	125kHz
IPC12	W#16#3132	Read Fixcode Read Words Write Words	4 Byte	8192 Byte	0000...07FF	125kHz
IUC72	W#16#3830	Read Fixcode Write Fixcode Read Word Write Words Read Special Fixcode Write Special Fixcode	8 Byte	64 Byte		865 ... 868 MHz
IUC73	W#16#3830	Read Fixcode Read Special Fixcode	8 Byte	-	-	868 MHz
IUC74	W#16#3830	Read Fixcode Write Fixcode Read Words Write Words Read Special Fixcode Write Special Fixcode	8 Byte	28 Byte		865 ... 871 MHz
IUC75	W#16#3830	Read Special Fixcode	96 Byte	-	-	868 MHz
IUC80	W#16#3830	Read Fixcode Write Fixcode Read Words Write Words Read Special Fixcode Write Special Fixcode	-	-	-	868 MHz
IQC21	W#16#3231	Read Fixcode Read Words Write Words	8 Byte	112 Byte	0000...001B	13,56MHz
IQC22	W#16#3232	Read Fixcode Read Words Write Words	8 Byte	256 Byte	0000...003F	13,56MHz
IQC23	W#16#3233	Read Fixcode Read Words Write Words	8 Byte	224 Byte	0000...0037	13,56MHz
IQC24	W#16#3234	Read Fixcode Read Words Write Words	8 Byte	928 Byte	0000...00E7	13,56MHz
IQC31	W#16#3331	Read Fixcode Read Words Write Words	8 Byte	32 Byte	0000...0007	13,56MHz
IQC33	W#16#3333	Read Fixcode Read Words Write Words	8 Byte	2000 Byte	0000...00F9	13,56MHz

2014-02



IQC35	W#16#3335	Read Fixcode Read Words Write Words	8 Byte	256 Byte	0000...003F	13,56MHz
MVC	W#16#3630	Read Fixcode Read Words Write Words	8 Byte	7552 Byte	0000...075F	2,45GHz

11 Table of Status Values

Head1(2)Status	Description	Action
0x00	Command has been executed without error	None; a new command has been sent to this channel
0xFF	Processing command	Command is being processed on this channel; a command can be sent to another channel (not the same channel)
0x01	Low battery (only applies to MVC read/write tags)	Usable data is included in the same telegram; it is recommended that the battery or the whole read/write tag be replaced
0x02	Switch-on message; reset command was executed	Control interface is ready for command execution
0x04	Incorrect or incomplete command; command parameter not in the valid range	Check the command parameters and the tag type (IQC33 has only even-numbered multiples of the WordNum); check the installation condition of the head (Is the head earthed? Has shielded cable been used?)
0x05	There is no read/write tag in the detection range.	Check the distance between the read/write tag and head; check the installation condition of the head (Is the head earthed? Has shielded cable been used?)
0x06	Hardware error; no read/write head connected to this channel; read/write head is faulty	Check the reader cable (shielded cable V1-G-XM-PUR ABG-V1-W); check the LED of the head (off: head faulty; flashing: initialization required; constant: head is OK)
0x07	Internal device error	Internal memory overflow (reduce the data hold time)
0x09	Parameterized tag type is not compatible with the connected reader	Check the defined tag type
0x0A	There are multiple tags in the detection range.	Make sure that only one tag is in the detection range during command execution
0x0B	Additional telegram with IF parameter switched on	None; telegram with additional information was sent
0x0F	Last telegram in multiframe mode	None; after a single command, number of tags read in the detection range in ASCII
0x20	Switch-on message; reset command was executed	Error was sent by the bus interface; control interface is ready for command execution
0x40	Incorrect or incomplete command; command parameter not in the valid range	Error was sent by the bus interface; check the command parameters and the tag type (IQC33 has only even-numbered multiples of the WordNum); check the installation condition of the head (Is the head earthed? Has shielded cable been used?)
0x60	Hardware error; no read/write head connected to this channel; read/write head is faulty	Error was sent by the bus interface; check the reader cable (shielded cable V1-G-XM-PUR ABG-V1-W); check the LED of the head (off: head faulty; flashing: initialization required; constant: head is OK)
0x70	Internal device error	Internal memory overflow (reduce the data hold time)

12 Table of Version History

Version	Date	Change to Function Block	Change to Documentation
2.0	11/18/2008	Adjustment from 4-channel version to 2-channel version Replacing the IN variable "IDENTControlAddress" with the IN variables INPUT/OUTPUT_Address and INPUT/OUTPUT_Length Output data length of 4 bytes possible through implementation of SFC81 Introduction of OUT variables Done; NoDataCarrier; Busy; and Error	First version
2.1	02/28/2009	Variable Memory.Error_SFC_14 is connected to the variables Head1/2Error Change to check of variables Head_1/2.ExistTC and Head_1/2.NotExist when parameterizing the commands -> trigger mode Introduction of the status check on the value 0x0F -> last telegram of the command list Change to the consistency check of the input and output data fields -> When executing the command list, the input and output data field are not equal Resetting the variable Head_1/2.QuitError in the Restart and QuitError routine Introduction of new symbol names for the usable data fields of the input and output data fields -> Head_1/2.InData/OutData.UserData Introduction of a value check of the parameter Head1/2WordNum -> Value > 15 is Head1/2Error set Output parameters Head1/2Status and Head1/2ReplyCounter introduced -> battery status and command list	New image introduced for the overview of the function block variables (page 4) New variables introduced in the function description table (page 4 – 5) Information on the maximum telegram length for different CPU series (page 6) Change to the variable name of the status value (page 6 – 7)
2.2	04/24/2009	Text library inserted for allocation of status messages	None
2.8	08/02/2013	Implementation of multiframe mode Parameterization of IUH readers now possible SpecialFixcode (EPC) readable/writeable Data blocks for processing the different telegrams on channel 1/2 inserted (DB70X & DB71X) SetRestart deletes content of the data blocks In/Out HeadXNewData displays new data in data blocks HeadXCACHEFull indicates data block overflow	Parameterization options with FB190 explained (page 6) New multiframe block FB33 explained (page 10) Update to various status values
2.9	09/04/2013	Filter functions added to FB33 FB190 displays incorrectly configured parameters	Filter functions explained (page 17) Fault analysis for parameter commands (page 8)
3.0	10/25/2013	FB190: Internal processes optimized, parameter error and parameter type error are now displayed correctly, parameters E5 and AP added	Status diagrams for all commands added Identification of inputs and outputs on the block Manual adapted to changelog



FABRIKAUTOMATION – SENSING YOUR NEEDS



Zentrale weltweit

Pepperl+Fuchs GmbH
68307 Mannheim · Deutschland
Tel. +49 621 776-0
E-Mail: info@de.pepperl-fuchs.com

Zentrale USA

Pepperl+Fuchs Inc.
Twinsburg, Ohio 44087 · USA
Tel. +1 330 4253555
E-Mail: sales@us.pepperl-fuchs.com

Zentrale Asien

Pepperl+Fuchs Pte Ltd.
Singapur 139942
Tel. +65 67799091
E-Mail: sales@sg.pepperl-fuchs.com

www.pepperl-fuchs.com

 **PEPPERL+FUCHS**
SENSING YOUR NEEDS