AS-Interface Safety Monitor

Connecting and Operating Instructions

Version V 3.08

Edition: 06/2009



© All rights reserved, in particular the rights of reproduction and translation. Copying or reproduction in any form requires prior written permission from copyright owner.
Product names are used without warranty of unrestricted applicability.
Changes due to technical improvement may be made.

Table of Contents

1	General Information	4
1.1	Explanation of symbols	4
1.2	Declaration of Conformity	4
1.3	Standards	4
1.4	Definition of terms	5
1.5	Abbreviations	6
1.6	Brief description	7
1.7	Different types of AS-interface safety monitors	10
2	Safety Notices	13
2.1	Safety standard	13
2.2	Intended use	13
2.2.1	Application requirements	13
2.2.2	Residual risks (EN 292-1)	13
2.2.3	Areas of application	14
2.3	Organisational measures	15
3	Specifications	16
3.1	General technical data	16
3.2	Safety-relevant characteristic data	18
3.3	Dimensioned drawings	21
3.4	Scope of delivery	21
4	Mounting	22
4.1	Mounting in the switching cabinet	22
5	Electrical connection type 1 and type 3	25
5.1	Terminal assignment	25
5.2	Connection overview	27
6	Electrical connection type 2 and type 4	28
6.1	Terminal assignment	28
6.2	Connection overview	30
7	Electrical connection type 5 and type 6	31
7.1	Terminal assignment	31
7.2	Connection overview	33
7.2.1	Connection for actuator monitoring	34
7.2.2	Connection for coupling to another AS-interface network	35
8	Electrical Connection of All Types	36
8.1	AS-interface bus connection	36
8.2	Serial interface	37

Table of Contents

9	Function and Commissioning	38
9.1	Function and operating modes	38
9.1.1	Start-up operation	38
9.1.2	Configuration operation	39
9.1.3	Protective operation	39
9.2	Display and operating elements	40
9.3	Switching on the device	41
9.4	Device configuration and parameterisation	41
9.5	Technical safety documentation for the application	42
10	Maintenance	43
10.1	Checking for safe shutdown	43
11	Status Display, Errors and Error Rectification	44
11.1	Status display on the device / error diagnosis on the PC	44
11.2	Troubleshooting tips	44
11.3	Error release with the "Service" button	44
11.4	Replacing defective safe AS-interface slaves	45
11.4.1	Replacing a defective safe AS-interface slave	45
11.4.2	Replacing several defective safe AS-interface slaves	45
11.5	Replacing a defective AS-interface safety monitor	47
11.6	What to do if you forget the password	48
12	Diagnostics via AS-interface	49
12.1	General procedure	49
12.2	Telegrams	50
12.2.1	Diagnosis of AS-interface safety monitor	50
12.2.2	Diagnosis of devices, sorted according to OSSD	53
12.2.3	Diagnosis of devices, unsorted	55
12.3	Example: Querying with diagnosis sorted according to OSSD	57

Table of Figures

Figure 1.1: Safe and standard components in an AS-interface network	7
Figure 1.2: Example - Monitoring of 2 decentral AS-interface actuator groups	8
Figure 1.3: Example - Safe coupling of two AS-interface networks	9
Figure 3.1: Example 1 - Calculation of the system reaction time.....	19
Figure 3.2: Example 2 - Calculation of the system reaction time.....	20
Figure 3.3: Example 3 - Calculation of the system reaction time.....	20
Figure 3.4: Dimensions	21
Figure 4.1: Mounting	22
Figure 4.2: Removable connection terminals	23
Figure 4.3: Removing and mounting encoded connection terminals.....	23
Figure 4.4: Mounting accessories for sealing the device	24
Figure 5.1: Terminal arrangement / block diagram of AS-interface safety monitor type 1 and type 3	25
Figure 5.2: Connection overview of AS-interface safety monitor type 1 and type 3	27
Figure 6.1: Terminal arrangement / block diagram of AS-interface safety monitor type 2 and type 4	28
Figure 6.2: Connection overview of AS-interface safety monitor type 2 and type 4	30
Figure 7.1: Terminal arrangement / block diagram of AS-interface safety monitor type 5 and type 6	31
Figure 7.2: Connection overview of AS-interface safety monitor type 5 and type 6	33
Figure 7.3: Connection of the terminals of the safe AS-interface output for actuator monitoring	34
Figure 7.4: Connection of the terminals of the safe AS-interface output for network coupling	35
Figure 8.1: AS-interface cable variants.....	36
Figure 8.2: Location of the RS 232C configuration interface	37
Figure 9.1: Overview of device LEDs	40
Figure 12.1: Querying with diagnosis sorted according to output circuit.....	57

1 General Information

1.1 Explanation of symbols

The symbols used in this operating manual are explained below.



Attention!

Pay attention to passages marked with this symbol. Failure to observe the provided instructions could lead to personal injury or damage to equipment.



Notice!

This symbol indicates text which contains important information.

1.2 Declaration of Conformity

The AS-interface safety monitor has been developed and manufactured in accordance with the applicable European standards and directives.



Notice!

The corresponding Declaration of Conformity and prototype test certificate can be found at the end of this operating manual.

The manufacturer of the product possesses a certified quality assurance system in accordance with ISO 9001.

1.3 Standards

- Draft: Fundamentals for the testing and certification of "Bus systems for the transmission of safety-relevant messages"
- EN 954-1:1996 - Safety of machines – safety-related elements of control systems
- EN ISO 13849-1:2007-07 - Safety of machines – safety-related elements of control systems - Part 1: General principles for design
- EN 50295:1999-10 - Low-voltage switching devices; control-system and device interfaces; actuator sensor interface (AS-interface)
- EN 60204-1:2006-06 - Safety of machines – electrical equipment for machines – Part 1: general requirements
- EN 60947-5-1:2005-02 - Low-voltage switchgear and controlgear - Part 5-1: control devices and switching elements; electromechanical control devices
- EN 61496-1:2005-01 - Non-contact safety guards
- IEC 61508 1-7:2000 - Functional safety of electric/electronic/programmable electronic systems with safety function

1.4 Definition of terms

Output switching element (safety output) of the AS-interface safety monitor

Element activated by the logic of the monitor which is able to safely switch off the downstream control elements. The output switching element may switch to or remain in the ON state only when all components are functioning as intended.

Output circuit

Consists of the two logically connected output switching elements.

OSSD

The safe AS-interface components and functional components assigned to an output circuit. They are responsible for releasing the machine element which generates the hazardous movement.

Integrated slave

Component in which sensor and/or actuator functions are grouped together with the slave to form a unit.

Configuration operation

Operating state of the safety monitor in which the configuration is loaded and checked.

Master

Component for data transmission which controls the logical and temporal behaviour on the AS-interface line.

External device monitoring circuit (contactor monitoring)

The external device monitoring circuit allows the switching function of the contactors connected to the AS-interface safety monitor to be monitored.

Safety output

See output switching element.

Safe input slave

Slave which reads in the safe ON or OFF state of the connected sensor or command device and transmits it to the master or safety monitor.

Safe slave

Slave for connecting safe sensors, actuators and other devices.

General Information

Safety monitor

Component which monitors the safe slaves and the correct function of the network.

Slave

Component for data transmission; the master cyclically addresses this component by its address. Only then does it generate an answer.

Standard slave

Slave for connecting non-safe sensors, actuators and other devices.

Synchronisation time

The maximum permissible temporal offset between the occurrence of two events which are dependent on one another.

1.5 Abbreviations

AS-interface	Actuator Sensor Interface
AOPD	Active Optoelectronic Protective Device
CRC	Cyclic Redundancy Check
I/O	Input/Output
EDM	External Device Monitoring
EMC	Electromagnetic compatibility
ESD	Electrostatic Discharge
PELV	Protective Extra-Low Voltage
PFD	Probability of Failure on Demand
PLC	Programmable Logic Control

1.6 Brief description

The actuator-sensor interface (AS-interface) has established itself as a system for networking primarily binary sensors and actuators at the lowest level of the automation hierarchy. The high number of installed systems, the ease of use and the reliable operating behaviour also make the AS-interface interesting in the area of machine safety.

The **safe** AS-interface system is intended for safety applications up to Category 4 in accordance with EN 954-1 and EN ISO 13849-1 PLe. Mixed operation of standard components and safe components is possible.

The AS-interface safety monitor monitors within an AS-interface system the safe slaves which have been assigned according to the configuration specified by the user with the configuration software. Depending on the device model, up to two dependent or independent OSSDs, each with external device monitoring circuit, are available. In the event of a stop request or a defect, the AS-interface safety monitor safely switches off the system in protective operation mode with a maximum reaction time of 40ms.

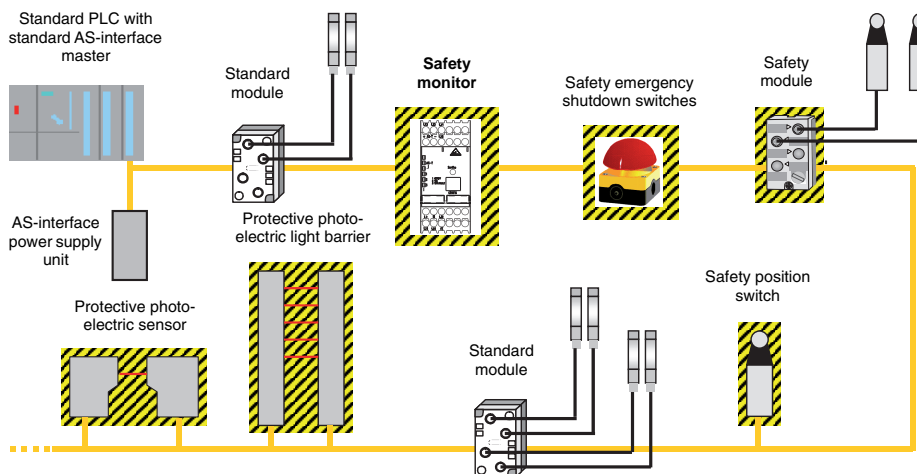

Figure 1.1: Safe and standard components in an AS-interface network

Multiple AS-interface safety monitors can be used within an AS-interface system. In this way, a safe slave can be monitored by multiple AS-interface safety monitors.

System expansion - decentral, safe AS-interface output slaves

With the system expansion focused on the **safe connection of decentral, safe AS-interface output slaves** acc. to IEC 61508 SIL 3, additional device models with a **safe AS-interface output** are made available. These models (type 5 / type 6) are used in the following applications:

1. Safe integration and monitoring of AS-interface actuators or AS-interface actuator groups, e.g. for enabling motor starters or valve units through the safe AS-interface output of the safety monitor.

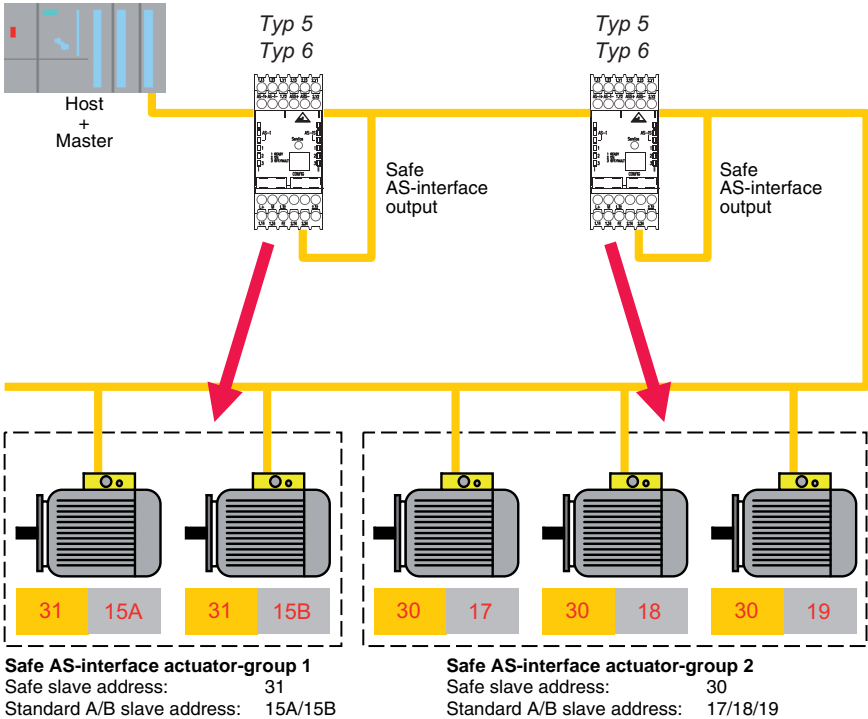

Figure 1.2: Example - Monitoring of 2 decentral AS-interface actuator groups



Notice!

An AS-interface safety monitor can only monitor one actuator group.

2. **Coupling of AS-interface networks** for the safe transmission of the state of an AS-interface safety monitor from one AS-interface network to another AS-interface network via the AS-interface using the function of the AS-interface safety monitor as a safe AS-interface input slave. This can be used, for example, for the creation of hierarchal networks for the realisation of a system stop which functions across an AS-interface network or for the implementation of a system restart from one location.

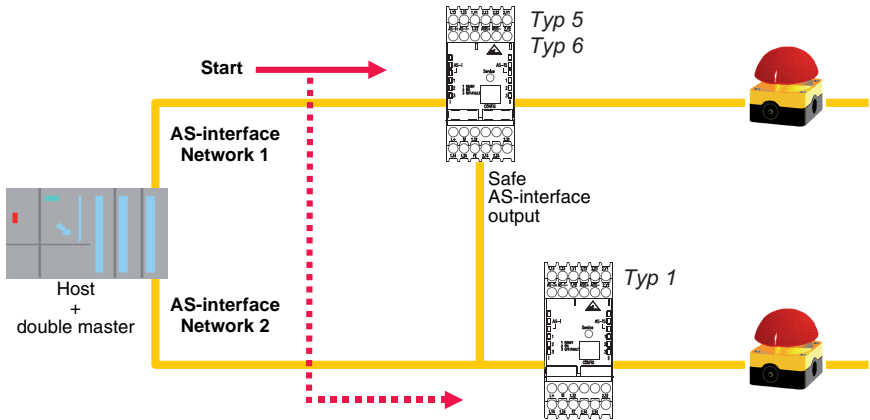

Figure 1.3: Example - Safe coupling of two AS-interface networks

General Information

1.7 Different types of AS-interface safety monitors

The AS-interface safety monitor has been further developed and expanded in functionality since the start of production in 2001.

The safety monitor is available in a total of 6 versions which differ with regard to the functions provided by the operating software and the initial configuration.



Notice!

A detailed description of all of the functions for the AS-interface safety monitor device versions listed in the following can be found in the user manual supplied with the **asimon** configuration software.

Versions of the operating software, version 2.0

The "Basic" and "Enhanced" function ranges differ as follows:

	"Basic"	"Enhanced"
Number of functional devices at logic level	32	48
OR gates (inputs)	2	6
AND gates (inputs)	no	6
Safe time function, switch-on and switch-off delay	no	yes
Function "button"	no	yes
Safety guard/module with debouncing	no	yes
Safety guard with lock	no	yes
Deactivation of functional devices	yes	yes
Reset of error condition	yes	yes
Diagnosis stop	yes	yes
Support of A/B technology for non-safe slaves	yes	yes
New functional devices (flip-flop, pulse on pos. edge, etc.)	no	yes
Dummy device (NOP)	no	yes

Table 1.1: "Basic" and "Enhanced" function ranges



Notice!

Device versions of operating software 2.0 are backwards compatible with device versions of the first version of the operating software 1.1 with the "Basic" function range.

New features beginning with Version 2.1 of the operating software

The following new features are included in version 2.1 of the operating software for the AS-interface safety monitor:

- New monitoring device **zero sequence detection**
- Expansion of the output device **door lock by means of delay time**: now optionally available with stop category 1 for the first OSSD
- Expansion of the output device **door lock by means of zero-speed relay and delay time**: now optionally available with stop category 1 for the first OSSD
- New start device **activation via standard slave** (level-sensitive)
- New start device **activation via monitor input** (level-sensitive)
- New monitoring device **operational switching by means of monitor input**
- Expansion of monitoring device **double channel dependent with debouncing** for local acknowledgement and startup test
- Expansion of monitoring device **double channel independent** for local acknowledgement and startup test
- Incremental teaching of the code sequences
- Device index assignment
- Display of inverted icon when standard slave is inverted
- Number of simulated slaves can be selected
- Signalling of relay outputs and message outputs via the AS-interface

Output configuration

Device types **type 1** and **type 3**: one switchable output circuit

Device types **type 2** and **type 4**: two separately switchable output circuits

Features of device versions

		Function range	
		"Basic"	"Enhanced"
Number of output circuits	1	Type 1	Type 3
	2	Type 2	Type 4

Table 1.2: Features of device versions type 1 ... type 4



Notice!

Device versions of operating software 2.1 are backwards compatible with device versions of operating software 1.1 and 2.0.

General Information

New features beginning with Version 3.0 of the operating software

In addition to the previous device types type 1 ... type 4, also supported are **two new device types** of version 3 (type 5 and type 6) of the AS-interface safety monitor **with safe AS-interface output**.

The following new features are included in version 3.0 of the operating software for the AS-interface safety monitor:

- Support of safe AS-interface transmission for **controlling safe AS-interface actuators**
- **Coupling of multiple safe AS-interface networks** through the function of the safety monitor as a safe input slave (only for new device types with safe AS-interface output)
- Monitoring device **Double channel dependent with filtering**
- **Manual entry of the code sequences** for safe AS-interface slaves
- Availability of the **standard out bit of the master for the safe slaves and the slaves simulated by the safety monitor** for operational switching tasks (acknowledgements, enabling, unlocking, etc.)

Output configuration

Device types **type 5** and **type 6**: two separately switchable output circuits

Features of device versions

			Function range "Enhanced"	
			Output circuit 1	Output circuit 2
Number of output circuits	2	Type 5	Relay	Safe AS-interface output
		Type 6	Relay	Relay + safe AS-interface output

Table 1.3: Features of device versions type 5 and type 6



Notice!

Device versions of operating software 3.0 are backwards compatible with device versions of operating software 1.1, 2.0 and 2.1.

New features beginning with Version 3.08 of the operating software

Beginning with Version 3.08 of the operating software for the AS-interface safety monitor, the "double channel dependent with debouncing" monitoring device is replaced within the device by the "double channel dependent with filtering" monitoring device.



Notice!

Device versions of operating software 3.08 are backwards compatible with device versions of operating software 1.1, 2.0, 2.1 and 3.0.

2 Safety Notices

2.1 Safety standard

The AS-interface safety monitor has been designed, manufactured, tested and presented for prototype design testing in accordance with the safety standards applicable at the time of testing. The safety requirements specified by SIL 3 acc. to IEC 61508, specified by category 4 acc. to EN 954-1 and specified by category 4 PL e acc. to EN ISO 13849-1 are fulfilled by all devices.



Notice!

A detailed list of failure probability values (PFD values) can be found in chapter 3.2.

Following a risk analysis, you may use the AS-interface safety monitor in accordance with its Safety Category (4) as a disconnecting protective device for securing danger areas.

2.2 Intended use

2.2.1 Application requirements

The AS-interface safety monitor has been designed as a **disconnecting protective device** for securing danger areas on power-driven working materials.



Attention!

The protection of personnel and the device cannot be guaranteed if the device is operated in a manner not corresponding to its intended use.



Attention!

Access and changes to the device, except where expressly described in this operating manual, are not authorised.

2.2.2 Residual risks (EN 292-1)

The wiring suggestions shown in this manual have been tested with utmost care. The relevant standards and regulations are adhered to if the shown components and appropriate wiring are used. Residual risks remain if:

- the suggested wiring concept is not adhered to and, as a result, the connected safety-relevant components or protective devices are not or are inadequately integrated into the safety circuit.
- relevant safety regulations specified for the operation, adjustment and maintenance of the machine are not adhered to by the operator. Here, the inspection and maintenance intervals for the machine should be strictly adhered to.

2.2.3 Areas of application

When used as intended, the AS-interface safety monitor allows the operation of sensor-controlled systems for the protection of persons and other protective components up to and including Category 4 acc. to EN 954-1 and EN ISO 13849-1 PL_e.

The safety monitor also performs the mandatory emergency shutdown function for all non-hand-operated machines (Stop Category 0 or 1), the dynamic monitoring of the restart function and the contactor control function.

Examples for the use of the AS-interface safety monitor:

The safety monitor is used commercially in machines and systems in which the standard AS-interface bus functions as the local bus. Thus, by using the safety monitor as a bus subscriber, existing AS-interface bus configurations can be expanded easily and safety elements with corresponding "AS-interface safety at work" interface easily integrated. If a safety component does not have an "AS-interface safety at work" interface, a so-called coupling module can be used to make the connection. Existing AS-interface master and AS-interface power supply units can continue to be used.

There are no branch-specific restrictions. Several of the primary areas of application are listed here:

- Machine tools
- Expanded machining machines with multiple control elements and safety sensors for wood and metal applications
- Printing and paper processing machines, cutting machines
- Packaging machines, single and as part of a system
- Food processing equipment
- Piece and bulk material transport systems
- Machinery in the rubber and plastics industry
- Assembly machines and manipulators

2.3 Organisational measures

Documentation

All entries in this operating manual must be heeded, in particular those in the sections "Safety Notices" and "Commissioning".

Keep this operating manual in a safe place. It should be accessible at all times.

Safety regulations

Observe the locally applicable legal regulations and the rules of the employer's liability insurance association.

Qualified personnel

Mounting, commissioning and maintenance of the device may only be carried out by qualified personnel.

Work on electrical installations may only be carried out by qualified electricians.

Settings and changes of the device configuration via PC and **asimon** configuration software must only be performed by an authorised safety officer.

The **password** for changing a device configuration is to be held under lock and key by the safety officer.

Repair

Repairs, in particular the opening of the housing, may only be carried out by the manufacturer or a person authorised by the manufacturer.

Disposal



Notice!

Electrical scrap is a special waste product! Observe the local regulations regarding disposal of the product.

The AS-interface safety monitor contains no batteries of any type which would need to be removed prior to disposal of the product.

3 Specifications

3.1 General technical data

Electrical data

Operating voltage U_b	24V DC +/- 15%	
Residual ripple	< 15%	
Rated operating current	Type 1 and type 3:	150mA
	Type 2, type 4 and type 5:	200mA
	Type 6:	250mA
Peak switch-on current ¹⁾	All types: 600mA	
Reaction time ²⁾ (safety-relevant)	< 40ms	
Delay before start-up	< 10s	

- 1) Simultaneous switch-on of all relays; the current for the message outputs is not taken into consideration
- 2) Attention! Please observe the notices for calculating the reaction times in chapter 3.2.



AS-interface data

AS-interface profile	Monitor 7.F
AS-interface voltage range	18.5 ... 31.6V
AS-interface current consumption	< 45mA
Number of devices per AS-interface branch	In a fully configured AS-interface network with 31 used standard addresses, it is possible to additionally install a maximum of four safety monitors without address. If fewer than 31 standard addresses are used, an additional monitor can be installed for each standard address that is not used. If additional subscribers are installed without address (e.g. earth-fault monitoring modules), the number of installable safety monitors is reduced accordingly. If repeaters are used, this applies for each segment.

Mechanical data

Dimensions (WxHxD)	45 mm x 105 mm x 120 mm	
Housing material	Polyamide PA 66	
Weight	Type 1 and type 3:	approx. 350g
	Type 5:	approx. 420g
	Type 2, type 4 and type 6:	approx. 450g
Mounting	Snap-on mounting on top-hat rail acc. to EN 50022	

Connection

 Ø 5 ... 6 mm / PZ2	0,8 ... 1,2 Nm 7 ... 10.3 LB.IN
	1 x (0,5 ... 4,0) mm ² 2 x (0,5 ... 2,5) mm ²
	1 x (0,5 ... 2,5) mm ² 2 x (0,5 ... 1,5) mm ²
AWG	2 x 20 ... 14

Specifications



Notice!

The safety monitor has been tested for interference-free operation acc. to EN 61000-4-2 with 8kV air discharging. The air discharging value of 15 kV stipulated by EN 61496-1 is not relevant for the safety monitor as the safety monitor is installed in a system which is contained either in a protective housing or a switching cabinet and the monitor can be accessed only by trained personnel. Nevertheless, we recommend that before the user inserts the configuration cable into the safety monitor he perform a discharge (earthing) at a suitable location.

3.2 Safety-relevant characteristic data

Characteristic data	Value	Standard
Safety category	4	EN 954-1
Safety category	4	EN ISO 13849-1
Performance Level (PL)	e	
Safety Integrated Level (SIL)	3	IEC 61508
Lifespan (TM) in years	20	EN ISO 13849-1
Maximum switch-on time in months	12	IEC 61508
PFD ¹⁾ for types 1, 2, 3, 4	$6.1 \cdot 10^{-5}$	IEC 61508
PFD ¹⁾ for types 5, 6	$7.2 \cdot 10^{-5}$	EN 62061
PFH _D ¹⁾ (probability of a dangerous failure per hour)	$9.1 \cdot 10^{-9}$	IEC 61508 EN 62061
Max. system reaction time ²⁾ in milliseconds	40	IEC 61508

1) The specified PFD and PFH_D values refer to the maximum switch-on time of 12 months and a maximum lifespan of 20 years acc. to EN ISO 13849-1.

2) Regarding the system reaction time:



Attention!

In addition to the system reaction time of max. 40ms, the reaction times of the safe AS-interface sensor slave, of the sensor being used for monitoring, of the safe AS-interface actuator slave and of the actuator used for this purpose must still be added. Please note that additional reaction times may likewise arise through the configuration of the safety monitor.

Table 3.1: Safety-relevant characteristic data



Notice!

Refer to the technical data for the slaves as well as to that for the sensors and actuators for the reaction times to be added.



Attention!

The system reaction times of the daisy-chained AS-interface components are added up.

System reaction times – example calculations

System components:

ASI1	AS-interface network 1	
ASI2	AS-interface network 2	
S1-1	Safe sensor slave	(EMERGENCY-OFF switch: $t_{R\ S1-1} = 100\text{ms}$)
S1-2	Safe sensor slave	(safety light barrier: $t_{R\ S1-2} = 18\text{ms}$)
S2-1	Safe sensor slave	(EMERGENCY-OFF switch: $t_{R\ S2-1} = 100\text{ms}$)
A2-1	Safe actuator slave	(motor starter: $t_{R\ A2-1} = 50\text{ms}$)
SM1-1	Safety monitor type 5 with one relay output and one safe AS-interface output in AS-interface network 1	
SM1-2	Safety monitor type 1 with one relay output in AS-interface network 1	
SM2-1	Safety monitor type 5 with one relay output and one safe AS-interface output in AS-interface network 2	

System configuration - example 1:

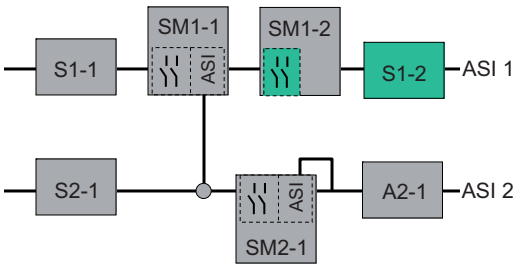

Figure 3.1: Example 1 - Calculation of the system reaction time

Upon activation of safety light barrier S1-2, the relay safety output of safety monitor SM1-2 is controlled.

Calculation of the AS-interface-relevant system reaction time:

$$t_{\text{System total a)}} = t_{R\ S1-2} + t_{R\ \text{system}} = 18\text{ms} + 40\text{ms} = \underline{58\text{ms}}$$

Specifications

System configuration - example 2:

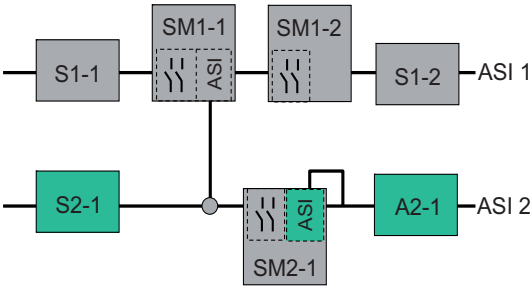

Figure 3.2: Example 2 - Calculation of the system reaction time

Upon locking of the EMERGENCY-OFF switch S2-1, the motor starter is controlled via the safe AS-interface output of safety monitor SM2-1.

Calculation of the AS-interface-relevant system reaction time:

$$t_{\text{System total b)}} = t_{R \text{ S2-1}} + t_{R \text{ system}} + t_{R \text{ A2-1}} = 100\text{ms} + 40\text{ms} + 50\text{ms} = \underline{190\text{ms}}$$

System configuration - example 3:

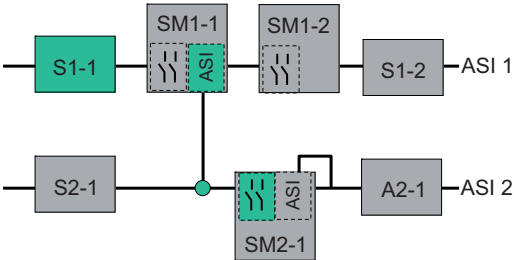

Figure 3.3: Example 3 - Calculation of the system reaction time

Upon locking of the EMERGENCY-OFF switch S1-1, the relay output of safety monitor SM2-1 is controlled via the coupling of the safe AS-interface output of safety monitor SM1-1.

Calculation of the AS-interface-relevant system reaction time:

$$t_{\text{System total c)}} = t_{R \text{ S1-1}} + t_{R \text{ system ASI1}} + t_{R \text{ system ASI2}} = 100\text{ms} + 40\text{ms} + 40\text{ms} = \underline{180\text{ms}}$$

3.3 Dimensioned drawings

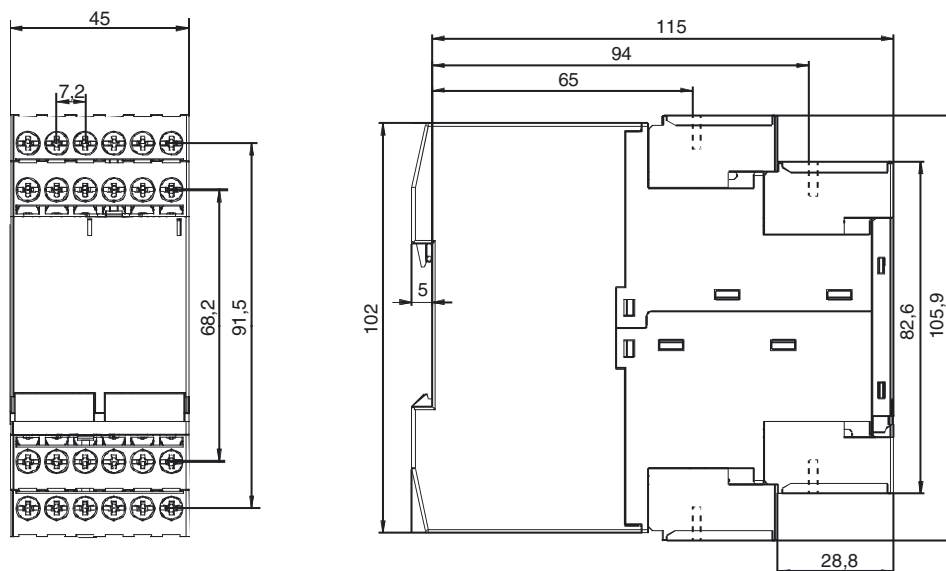

Figure 3.4: Dimensions

3.4 Scope of delivery

The **basic unit** consists of:

- AS-interface safety monitor type 1, type 2, type 3, type 4, type 5 or type 6

The following **accessories** are available:

- Configuration interface cable (RJ45/SubD 9 pin) for the PC/safety monitor connection
- Software CD with
 - **asimon** communication software for Microsoft® Windows 9x/Me/NT/2000/XP/Vista®
 - operating manual in PDF format
(Adobe® Acrobat Reader® Version 4.x or newer is required for viewing the files)
- Operating manual
- Download cable (RJ45/RJ45) for the safety monitor/safety monitor connection
- Device front cover for protection and sealing

4 Mounting

4.1 Mounting in the switching cabinet

The AS-interface safety monitor is mounted on 35mm standard rails acc. to DIN EN 50022 in the switching cabinet.



Attention!

The housing of the AS-interface safety monitor is not suitable for open wall mounting. Provide a protective housing in all cases when the device is not mounted in the switching cabinet.

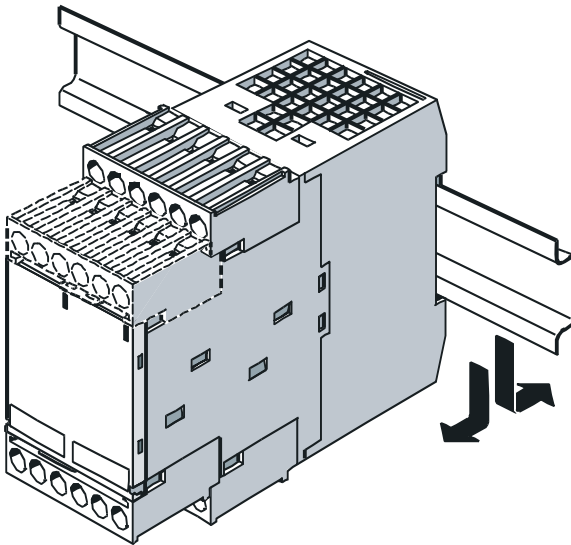

Figure 4.1: Mounting

To mount, position the device on the upper edge of the standard rail and then snap it onto the bottom edge. To remove, firmly press the device against the upper rail guide and lift out.



Notice!

When drilling above the device, cover the AS-interface safety monitor. No particles, no metal shavings in particular, should be allowed to penetrate into the housing through ventilation openings as they may cause a short-circuit.

To prevent malfunctions, it is recommended that the operating temperature of the AS-interface safety monitor specified in the technical data for switching-cabinet installation be maintained. It is recommended that a minimum spacing of 10mm be maintained between multiple safety monitors and other switching cabinet components.

Removable connection terminals

The AS-interface safety monitor contains encoded, removable connection terminals (A, B, C, D in figure 4.2).

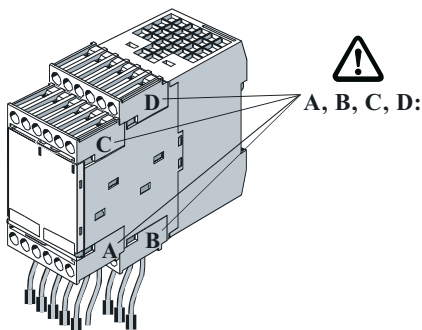

Figure 4.2: Removable connection terminals

To remove the encoded connection terminals, push back the safety spring **a** and pull the terminals out towards the front (figure 4.3). When mounting, the connection terminals must audibly lock into place.

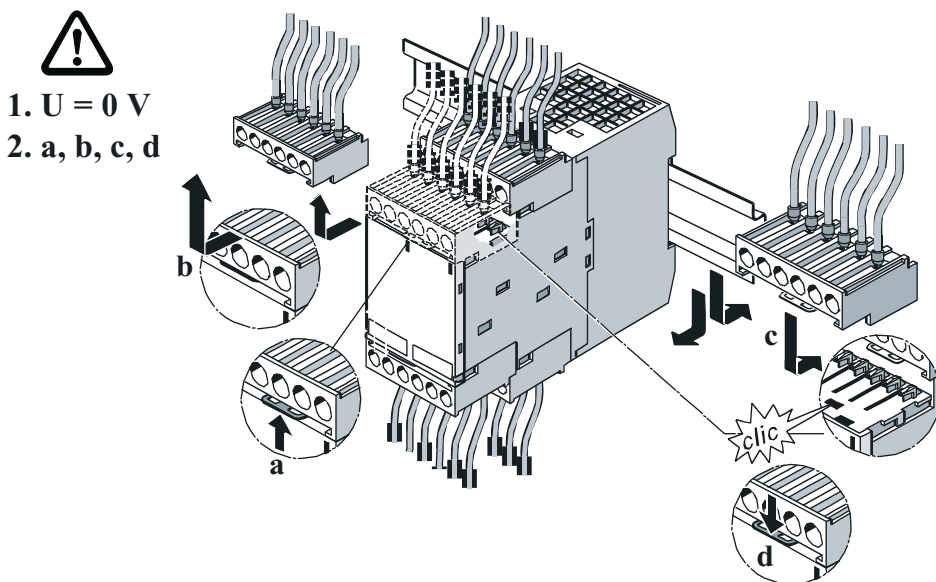

Figure 4.3: Removing and mounting encoded connection terminals

Mounting

Mounting accessories

As the AS-interface safety monitor is a safety component, it is possible to protect the device from unauthorised access by sealing the **CONFIG** configuration interface and the **Service** button. Included in the delivery contents for the device is a transparent cover with safety hook through which you can pass a lead sealing wire or thread when the device is in its mounted state (see figure 4.4). You must break the safety hook off the cover before using.

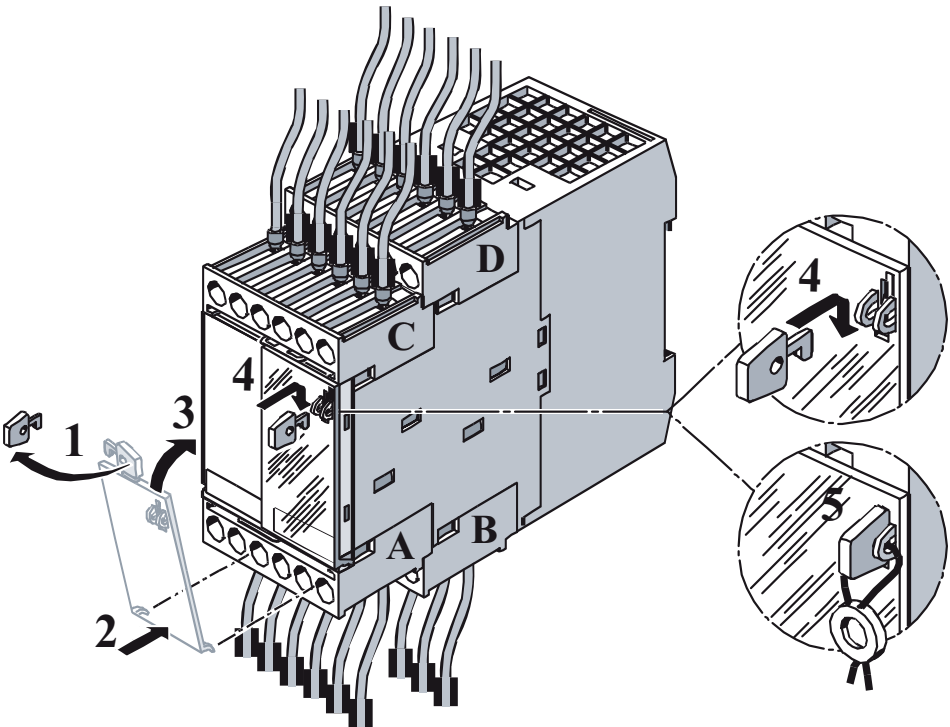

Figure 4.4: Mounting accessories for sealing the device



Notice!

The transparent cover with safety hook should always be used as they provide good protection against electrostatic discharges (ESD) and the penetration of foreign bodies into the **CONFIG** socket of the AS-interface safety-monitor configuration interface.

The sealing wire is not included in the delivery contents.

5 Electrical connection type 1 and type 3



Notice!

Work on electrical installations may only be carried out by qualified electricians.

5.1 Terminal assignment

Terminal arrangement / block diagram

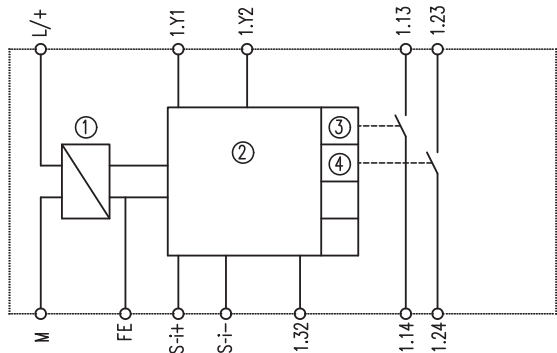
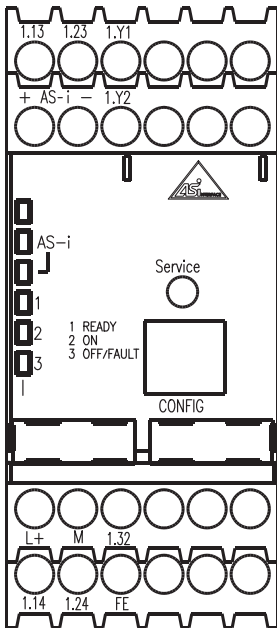

- ① Power supply unit
- ② Control logic
- ③ Control for output switching element 1
- ④ Control for output switching element 2

Figure 5.1: Terminal arrangement / block diagram of AS-interface safety monitor type 1 and type 3

Electrical connection type 1 and type 3

Terminal assignment

Terminal	Signal / description
AS-i+	Connection at the AS-interface bus
AS-i-	
L+	+24V DC / supply voltage
M	GND / reference ground
FE	Functional earth
1.Y1	EDM 1 / input of external device monitoring circuit
1.Y2	Start 1 / start input
1.13 ¹⁾	Output switching element 1
1.14	
1.23 ¹⁾	Output switching element 2
1.24	
1.32	Message output "safety on"

1) Safeguard according to technical data

Table 5.1: Terminal assignment of AS-interface safety monitor type 1 and type 3



Notice!

The connection of the earth lead to terminal FE is not necessary if terminal M is connected to earth in the direct vicinity of the device.



Attention!

The AS-interface power supply unit for supplying the AS-interface components must demonstrate safe mains separation acc. to IEC 60742 and the ability to bridge short-term mains failures of up to 20ms. The power supply unit for 24V supply must also demonstrate safe mains separation acc. to IEC 60742 and the ability to bridge short-term mains failures of up to 20ms.

5.2 Connection overview

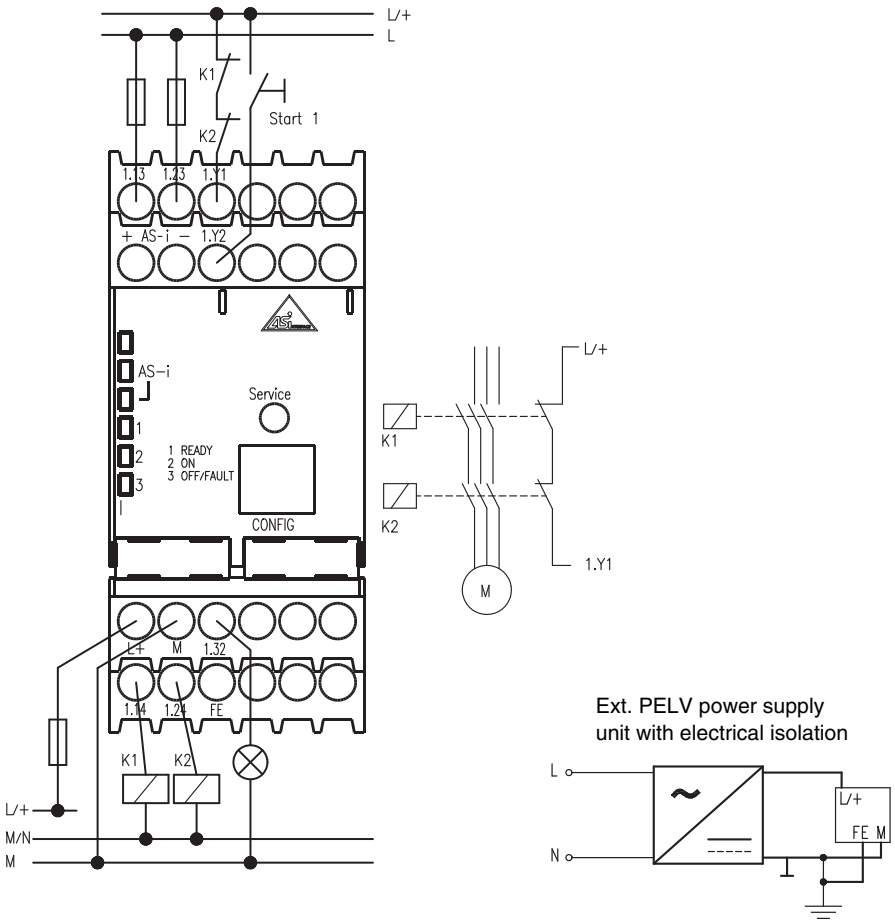

Figure 5.2: Connection overview of AS-interface safety monitor type 1 and type 3

6 Electrical connection type 2 and type 4



Notice!

Work on electrical installations may only be carried out by qualified electricians.

6.1 Terminal assignment

Terminal arrangement

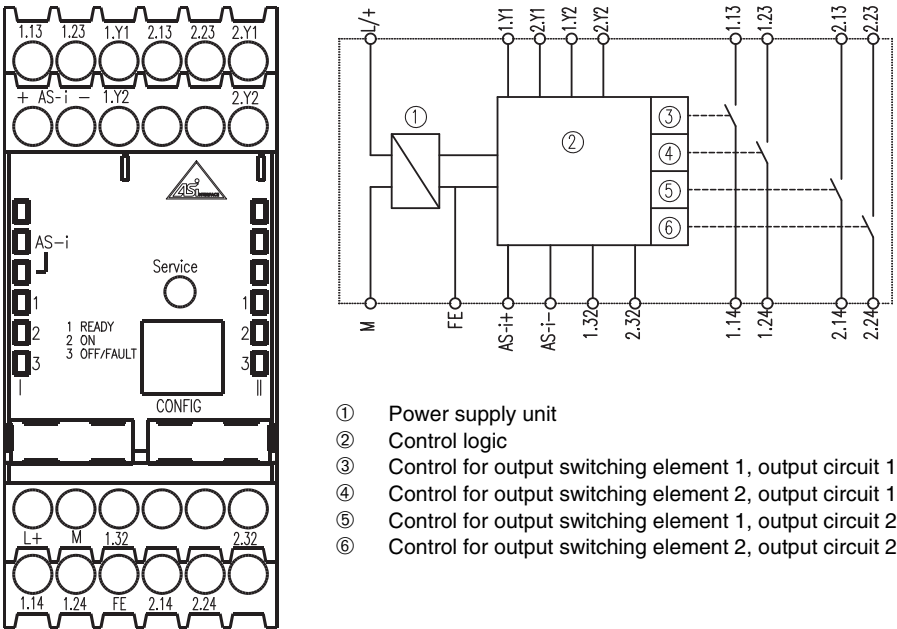

Figure 6.1: Terminal arrangement / block diagram of AS-interface safety monitor type 2 and type 4

Terminal assignment

Terminal	Signal / description
AS-i+	Connection at the AS-interface bus
AS-i-	
L+	+24V DC / supply voltage
M	GND / reference ground
FE	Functional earth
1.Y1	EDM 1 / input of external device monitoring circuit, output circuit 1
1.Y2	Start 1 / start input, output circuit 1
1.13 ¹⁾	Output switching element 1, output circuit 1
1.14	
1.23 ¹⁾	Output switching element 2, output circuit 1
1.24	
1.32	Message output 1 "Safety on", output circuit 1
2.Y1	EDM 2 / input of external device monitoring circuit, output circuit 2
2.Y2	Start 2 / start input, output circuit 2
2.13 ¹⁾	Output switching element 1, output circuit 2
2.14	
2.23 ¹⁾	Output switching element 2, output circuit 2
2.24	
2.32	Message output 2 "Safety on", output circuit 2

1) Safeguard according to technical data

Table 6.1: Terminal assignment of AS-interface safety monitor type 2 and type 4



Notice!

The connection of the earth lead to terminal FE is not necessary if terminal M is connected to earth in the direct vicinity of the device.



Attention!

The AS-interface power supply unit for supplying the AS-interface components must demonstrate safe mains separation acc. to IEC 60742 and the ability to bridge short-term mains failures of up to 20ms. The power supply unit for 24V supply must also demonstrate safe mains separation acc. to IEC 60742 and the ability to bridge short-term mains failures of up to 20ms.

6.2 Connection overview

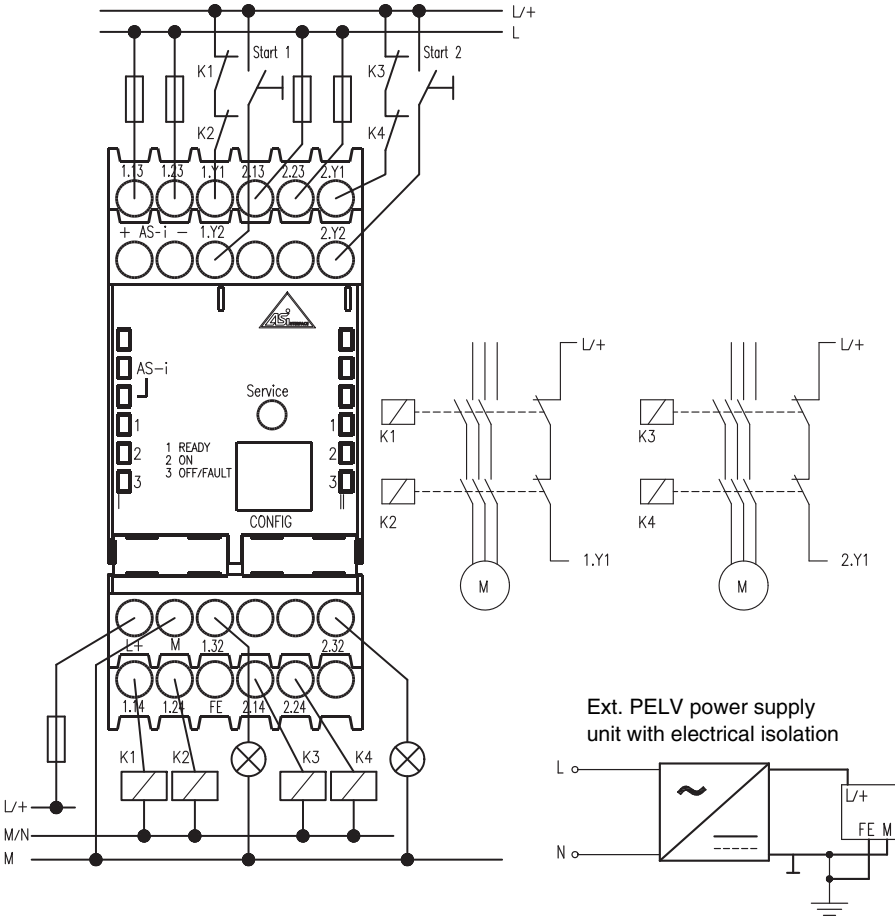

Figure 6.2: Connection overview of AS-interface safety monitor type 2 and type 4

7 Electrical connection type 5 and type 6



Notice!

Work on electrical installations may only be carried out by qualified electricians.

7.1 Terminal assignment

Terminal arrangement

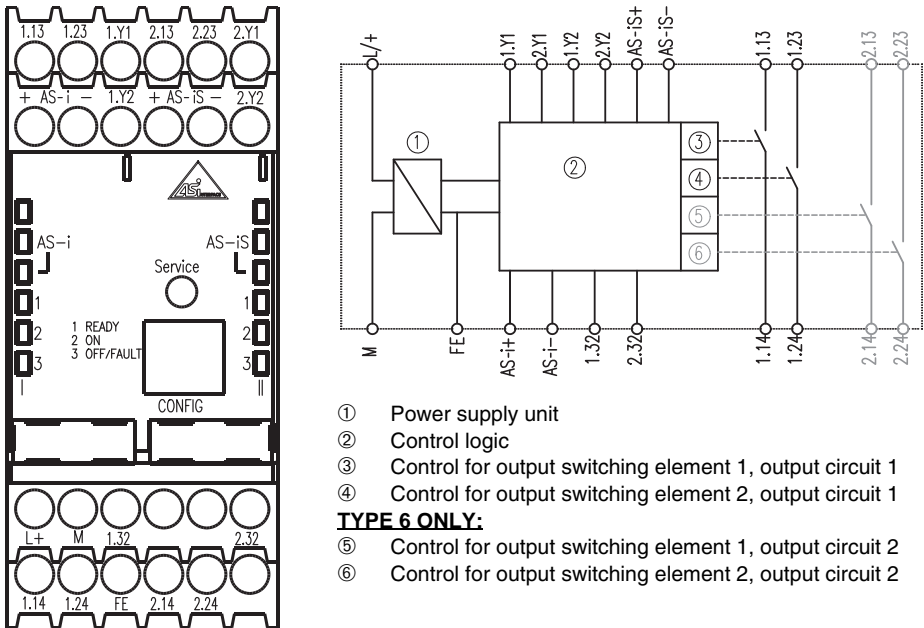

Figure 7.1: Terminal arrangement / block diagram of AS-interface safety monitor type 5 and type 6

Electrical connection type 5 and type 6

Terminal assignment

Terminal	Signal / description
AS-i+	Connection at the AS-interface bus
AS-i-	
AS-iS+	Safe AS-interface output for actuator monitoring or coupling of another AS-interface network
AS-iS-	
L+	+24V DC / supply voltage
M	GND / reference ground
FE	Functional earth
1.Y1	EDM 1 / input of external device monitoring circuit, output circuit 1
1.Y2	
1.13 ¹⁾	Output switching element 1, output circuit 1
1.14	
1.23 ¹⁾	Output switching element 2, output circuit 1
1.24	
1.32	Message output 1 "Safety on", output circuit 1
2.Y1	EDM 2 / input of external device monitoring circuit, output circuit 2
2.Y2	
2.13 ¹⁾	Output switching element 1, output circuit 2 (type 6 only!)
2.14	
2.23 ¹⁾	Output switching element 2, output circuit 2 (type 6 only!)
2.24	
2.32	Message output 2 "Safety on", output circuit 2

1) Safeguard according to technical data

Table 7.1: Terminal assignment of AS-interface safety monitor type 5 and type 6



Notice!

The connection of the earth lead to terminal FE is not necessary if terminal M is connected to earth in the direct vicinity of the device.



Attention!

The AS-interface power supply unit for supplying the AS-interface components must demonstrate safe mains separation acc. to IEC 60742 and the ability to bridge short-term mains failures of up to 20ms. The power supply unit for 24V supply must also demonstrate safe mains separation acc. to IEC 60742 and the ability to bridge short-term mains failures of up to 20ms.



Attention!

Make absolutely certain that terminals AS-iS+ and AS-iS- of the safe AS-interface output are properly connected acc. to chapter 7.2.1 or chapter 7.2.2.

7.2 Connection overview

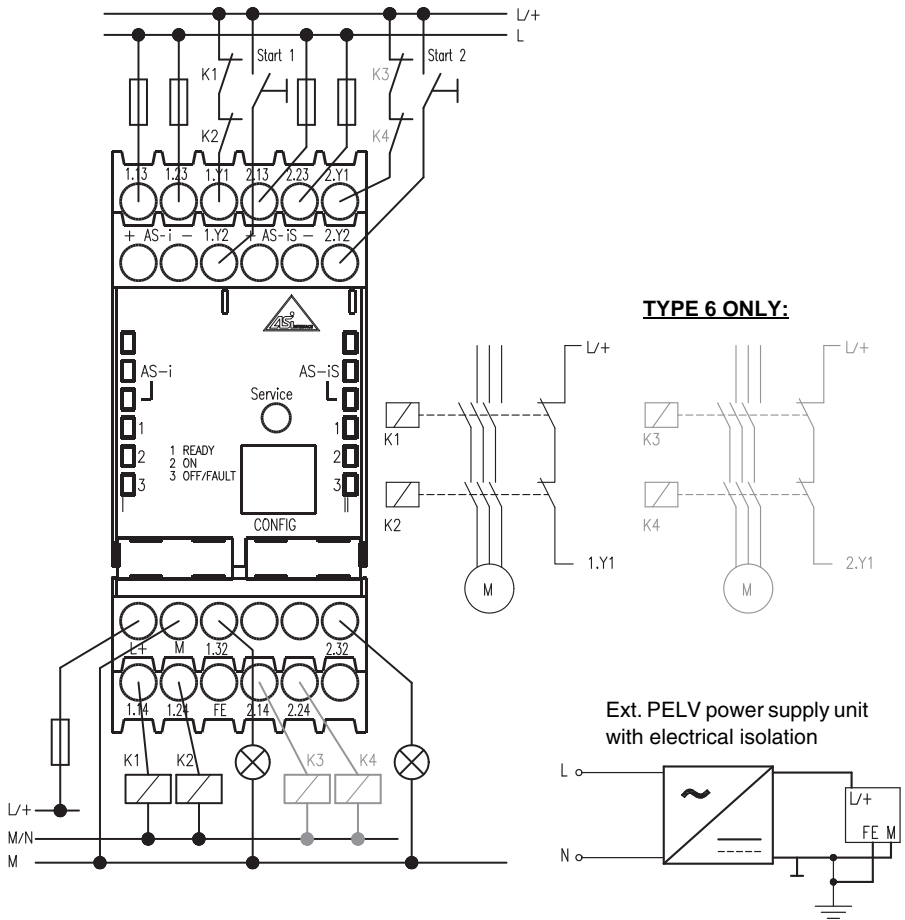

Figure 7.2: Connection overview of AS-interface safety monitor type 5 and type 6



Notice!

With AS-interface safety monitor type 5, the inputs for contactor monitoring (2.Y1) and start (2.Y2) as well as message output (2.32) are present in spite of the missing output switching elements for output circuit 2.

7.2.1 Connection for actuator monitoring



Attention!

Terminal **AS-iS+** must be connected to **AS-i+** and **AS-iS-** must be connected to **AS-i-** of the same AS-interface safety monitor.

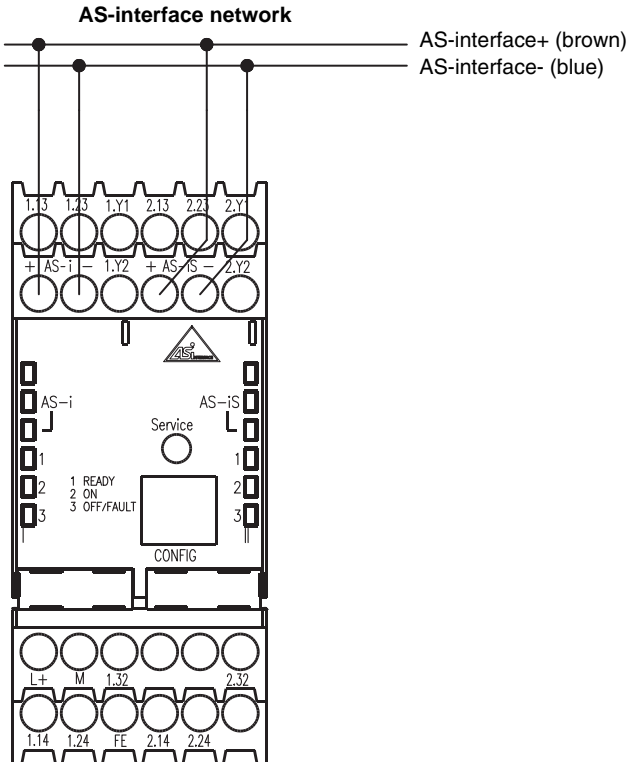

Figure 7.3: Connection of the terminals of the safe AS-interface output for actuator monitoring

7.2.2 Connection for coupling to another AS-interface network

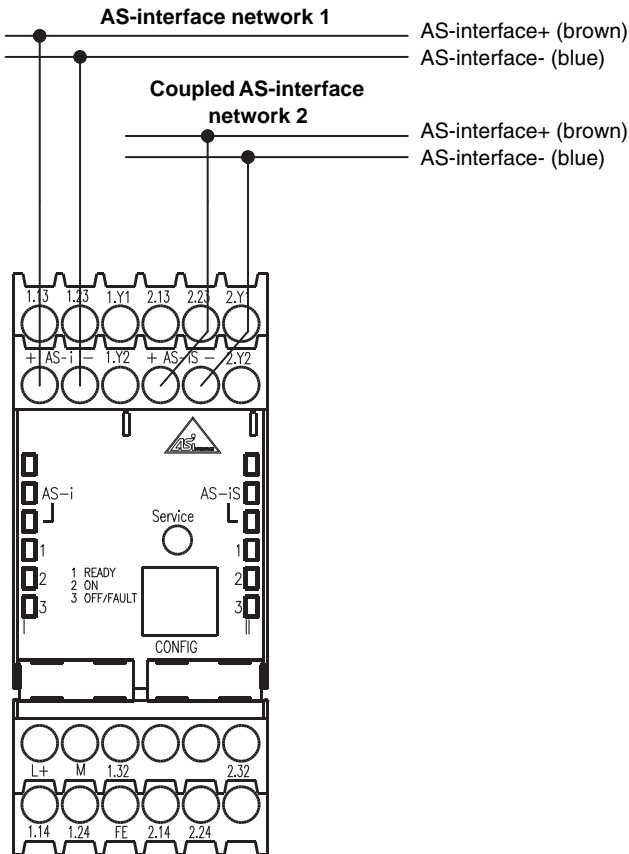

Figure 7.4: Connection of the terminals of the safe AS-interface output for network coupling

8 Electrical Connection of All Types



Notice!

Work on electrical installations may only be carried out by qualified electricians.

Unused terminals must remain unoccupied and must not be used for other functions!

8.1 AS-interface bus connection

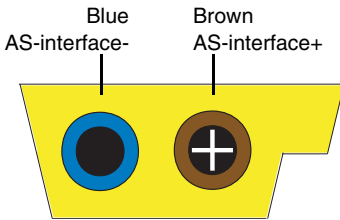

Yellow AS-interface ribbon cable

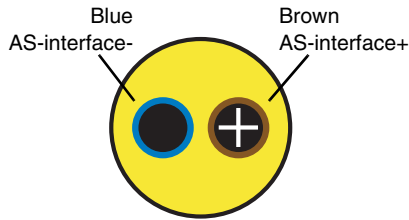

Two-conductor AS-interface round cable
(recommended: flexible power cable
H05VV-F2x1.5 acc. to DIN VDE 0281)

Figure 8.1: AS-interface cable variants

8.2 Serial interface

The serial RS 232C interface **CONFIG** is used for communication between PC and device and is permanently set to a baud rate of 9600 baud.

The interface is provided on the AS-interface safety monitor as an RJ45 socket. A matching interface cable with 9-pin subD connector is available as an accessory.



Attention!

Use only the optional interface cable. The use of other cables may lead to functional disturbances or damage to the connected AS-interface safety monitor.

Configuration interface RS 232C

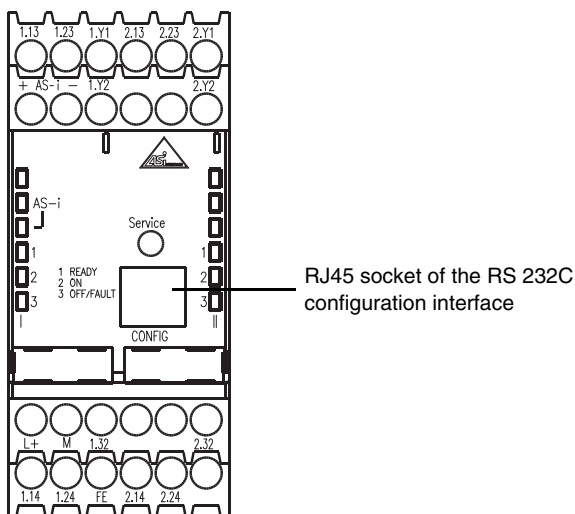

Figure 8.2: Location of the RS 232C configuration interface

9 Function and Commissioning

The configuration and commissioning of the AS-interface safety monitor is performed using a PC/notebook with the **asimon** configuration software.



Notice!

*The description of the **asimon** software and the commissioning of the AS-interface safety monitor can be found in the "asimon - AS-interface safety monitor configuration software for Microsoft®-Windows®" manual.*

*The software manual is an important part of the operating manual for the AS-interface safety monitor. Configuration and commissioning of the AS-interface safety monitor is not possible without the **asimon** software.*

Configuration may be performed only by a safety officer. All commands relevant to safety are protected by a password.

9.1 Function and operating modes

With the AS-interface safety monitor, a distinction is made between 3 operating modes:

- Start-up operation
- Configuration operation
- Protective operation

9.1.1 Start-up operation

After switching on, the microcontrollers in the AS-interface safety monitor first perform a system test of the hardware and internal software. If an internal device error is detected, the other device initialisation processes are stopped and the output switching elements remain switched off.

If all internal tests are completed successfully, the AS-interface safety monitor checks whether a valid, validated configuration is stored in the internal configuration memory.

If yes, this configuration is loaded, the necessary data structures assembled and the device switches to protective operation. Depending on the configuration, the output switching elements are then switched on or remain switched off.

If either no configuration or a faulty configuration is detected in the configuration memory, the device switches to configuration operation. The output switching elements remain switched off.

9.1.2 Configuration operation

In configuration operation of the AS-interface safety monitor, a command processing module is activated which communicates via the serial configuration interface with the **asimon** software installed on the PC/notebook (see the "asimon - AS-interface safety monitor configuration software for Microsoft®-Windows®" manual). Data transmission is monitored for transmission errors and, if necessary, repeated.

It is possible to switch to configuration operation by

- sending the password-protected command **stop** while in protective operation from the **asimon** software. Configured shutdown delay times are to be taken into account here.
- sending the command **stop** while in protective operation from the **asimon** software without entering a password. This is only possible if there is no communication on the AS-interface line. You can ensure that this is the case by, for example, directly disconnecting the AS-interface line from the monitor.
- detecting a missing or faulty configuration in start-up operation.
- pressing the **Service** button for the first time when replacing a defective safe AS-interface slave (see chapter 11.4 "Replacing defective safe AS-interface slaves").

9.1.3 Protective operation

Protective operation is the normal operating mode of the AS-interface safety monitor. In this mode the output switching elements are activated and deactivated depending on the operating state of the monitored safe AS-interface slaves and configured functional components.

In protective operation, the AS-interface safety monitor continuously transmits diagnostic data via the serial configuration interface. This data is processed by the **asimon** software.

If an internal error function is detected during protective operation of the AS-interface safety monitor, the output switching elements are switched off immediately and without regard to any set delay times. The AS-interface safety monitor then performs a self test again. If the error no longer exists, the AS-interface safety monitor returns to protective operation. If the error still exists, this state is error-locked and can be exited only by switching the AS-interface safety monitor back on.

It is possible to switch to protective operation by

- sending the command **start** while in configuration operation from the **asimon** software.
- detecting a valid, validated configuration in start-up operation.
- pressing the **Service** button for the second time when replacing a defective safe AS-interface slave (see chapter 11.4 "Replacing defective safe AS-interface slaves").

9.2 Display and operating elements

The LED indicators on the front side of the AS-interface safety monitor provide information about the operating mode and the device state.

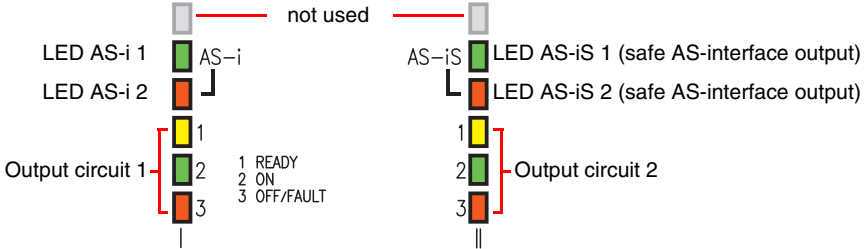











Figure 9.1: Overview of device LEDs

Meanings of the LED indicators in protective operation

LED	Colour		Meaning
AS-i 1		off	no supply
		green, continuous	AS-interface supply present
AS-i 2		off	normal operation
		red, continuous	communication error
AS-iS 1		off	no supply
		green, continuous	AS-interface supply present
AS-iS 2		off	normal operation
		red, continuous	communication error
1 READY (per output circuit)		off	–
		yellow, continuous	start-up/restart-disable active
		yellow, flashing	external test necessary / acknowledgement / delay before start-up active

LED	Colour	Meaning
2 ON (per output circuit)		off contacts of the output switching element open
		green, continuous contacts of the output switching element closed
		green, flashing delay time runs in event of Stop Category 1
3 OFF/FAULT (per output circuit)		off contacts of the output switching element closed
		red, continuous contacts of the output switching element open
		red, flashing error on level of the monitored AS-interface components
1 READY 2 ON 3 OFF/FAULT (per output circuit)	  	simultaneously flashing rapidly internal device error, error message can be queried by means of asimon software



Notice!

Pressing the **Service** button is acknowledged by a one-time, brief illumination of all device LEDs.



Attention!

Actuation force for the **Service** button: max. 1N!

9.3 Switching on the device

As soon as the supply voltage is present at the device, the internal system test begins. This operating status is indicated by the switching on of all LEDs installed in the device (see chapter 9.1.1 "Start-up operation").

9.4 Device configuration and parameterisation

For the device configuration and parameterisation, you require the software program **asimon**.

The **asimon** software is responsible for the following tasks:

- Configuring the AS-interface safety monitor
- Documentation of the device configuration
- Commissioning the AS-interface safety monitor
- Diagnosis of the AS-interface safety monitor



Notice!

The description of the **asimon** program can be found in the separate software manual.

Configuration operation (chapter 9.1.2) is indicated by sequential illumination of LEDs 1 ... 3 of the output circuit 1.

Proceed as follows:

- Install the program on your PC.
- Apply the supply voltage to the AS-interface safety monitor.



Notice!

We recommend that before the user inserts the configuration cable into the safety monitor he perform a discharge (earthing) at a suitable location.

- Use the interface cable (RJ45/SubD 9-pin) to connect the PC to the AS-interface safety monitor (see chapter 2.1.2 "Connection between the AS-interface safety monitor and the PC" of the software manual).
- Configure the AS-interface safety monitor and put it into operation as described in the software manual.
- The AS-interface safety monitor is ready for operation following commissioning.



Attention!

Before commissioning the device you **must** adapt the device configuration to your application. To do this, configure the AS-interface safety monitor as described in the software manual in such a way that the given danger area is protected by the device.

9.5 Technical safety documentation for the application



Attention!

The validated configuration log signed by the safety officer must be filed with the safety documentation of the user application.



Notice!

The detailed description of the technical safety documentation for the configuration of your application can be found in the separate software manual.

Proceed as follows:

- Create the AS-interface safety monitor configuration for your application.
- Validate the configuration (to be performed by the safety officer).
- Print out the final configuration log and, optionally, the configuration overview (see chapter 5.8 "Configuration documentation" of the software manual).
- Sign the final configuration log (to be performed by the safety officer).
- File the log together with the other technical safety documentation for your application (machine documentation) and store in a safe location.

10 Maintenance

10.1 Checking for safe shutdown

The proper function of the AS-interface safety monitor within the system to be secured, i.e. the safe shutdown following the triggering of an assigned safe sensor or switch, is to be checked at least annually by the safety officer.



Attention!

This is to be performed by activating each safe AS-interface slave at least once per year and visually inspecting the switching behaviour of the output circuits of the AS-interface safety monitor.



Attention!

The specified PFD and PFH_D values refer to a maximum switch-on time of 12 months and a maximum lifespan of 20 years acc. to EN ISO 13849-1.

11 Status Display, Errors and Error Rectification

11.1 Status display on the device / error diagnosis on the PC

An internal or external error is indicated by the red flashing LED **OFF/FAULT** on the AS-interface safety monitor (see chapter 9.2 "Display and operating elements").



Notice!

A more exact diagnosis of the error is possible via the configuration interface using the **asimon** software (see software manual).

11.2 Troubleshooting tips

Error	Possible cause	Remedy
LED AS-i 1 is off	No AS-interface supply	<ul style="list-style-type: none">• Check line connections• Check AS-interface power supply unit
LED AS-i 2 illuminates red	Communication on the AS-interface bus is faulty	<ul style="list-style-type: none">• Check line connections• Check AS-interface master
LED AS-iS 1 is off	No AS-interface supply	<ul style="list-style-type: none">• Check line connections• Check AS-interface power supply unit
LED AS-iS 2 illuminates red	Communication on the AS-interface bus is faulty	<ul style="list-style-type: none">• Check line connections• Check AS-interface master
LED 3 OFF/FAULT flashes red	Error on level of the monitored AS-interface components	<ul style="list-style-type: none">• Perform diagnostics with asimon• If necessary, replace defective AS-interface components
LEDs 1 ... 3 simultaneously flashing rapidly	Internal device error	<ul style="list-style-type: none">• Note down the error numbers displayed by asimon in the error message window and contact the manufacturer

11.3 Error release with the "Service" button

An error-locked safety monitor (red LED **3 OFF/FAULT** flashes) can be released by pressing the "Service" button. The device with the error is reset when the button is pressed. A start test must be performed on this device after the reset.



Notice!

Pressing the **Service** button is acknowledged by a one-time, brief illumination of all device LEDs.

11.4 Replacing defective safe AS-interface slaves

11.4.1 Replacing a defective safe AS-interface slave

If a safe AS-interface slave is defective, it is possible to replace it without a PC and without reconfiguring the AS-interface safety monitor by using the **Service** button on the AS-interface safety monitor.



Attention!

Actuation force for the **Service** button: max. 1 N!



Notice!

When the **Service** button is pressed, the safety monitor switches from protective operation to configuration operation. The output circuits are therefore deactivated in all cases.

Pressing the **Service** button is acknowledged by a one-time, brief illumination of all device LEDs.

Proceed as follows:

1. Disconnect the defective AS-interface slave from the AS-interface line.
2. Press the **Service** button for approx. 1 second on all AS-interface safety monitors which use the defective safe AS-interface slave.
3. Connect the new safe AS-interface slave to the AS-interface line.
4. Press the **Service** button again for approx. 1 second on all AS-interface safety monitors which use the replaced safe AS-interface slave.

The first time the **Service** button is pressed, the monitor determines whether exactly one slave is missing. This is noted in the error memory of the AS-interface safety monitor. The AS-interface safety monitor switches to configuration operation. The second time the **Service** button is pressed, the code sequence of the new slave is read in and checked for correctness. If the code sequence is OK, the AS-interface safety monitor returns to protective operation.



Attention!

After replacing a defective safe slave, make certain to check the new slave for correct function.

11.4.2 Replacing several defective safe AS-interface slaves

If more than one safe AS-interface slave on an AS-interface branch is defective, the devices must be replaced in the following way:



Notice!

When the **Service** button is pressed, the safety monitor switches from protective operation to configuration operation. The output circuits are therefore deactivated in all cases.

Pressing the **Service** button is acknowledged by a one-time, brief illumination of all device LEDs.



Attention!

Actuation force for the **Service** button: max. 1 N!

1. Disconnect all defective AS-interface slaves from the AS-interface line. Connect all new, **already addressed** safe AS-interface slaves **except one** to the AS-interface line (Auto_Address does not function in this case).
2. Activate all newly connected slaves so that no code sequences are sent by the slave (actuate emergency shutdown, open door, break light barrier, etc.).



Notice!

The error detection function integrated in the monitor only accepts a new slave if point 2 is fully observed.

3. Press the **Service** button for approx. one second on all AS-interface safety monitors which used the defective safe AS-interface slaves.
4. Connect the last missing and already addressed slave to the AS-interface line.
5. Press the **Service** button for approx. one second on all AS-interface safety monitors which used the defective safe AS-interface slaves.
6. Disconnect one of the replaced and not yet taught AS-interface slaves from the AS-interface line.
7. Press the **Service** button for approx. one second on all AS-interface safety monitors which used the defective safe AS-interface slaves.
8. Reconnect the previously disconnected AS-interface slave to the AS-interface line.
9. Activate the newly connected slave. The code sequence is now transmitted to the AS-interface safety monitor and stored there.
10. Press the **Service** button for approx. one second on all AS-interface safety monitors which used the defective safe AS-interface slaves.
11. Repeat the procedure from step 6 onwards until all replaced AS-interface slaves have been taught.

The first time the **Service** button is pressed, the monitor determines whether exactly one slave is missing. This is noted in the error memory of the AS-interface safety monitor. The AS-interface safety monitor switches to configuration operation. The second time the **Service** button is pressed, the code sequence of the new slave is read in and checked for correctness. If the code sequence is OK, the AS-interface safety monitor returns to protective operation.



Attention!

After replacing the defective safe slaves, make certain to check the new slaves for correct function.

11.5 Replacing a defective AS-interface safety monitor

If an AS-interface safety monitor is defective and must be replaced, the replacement device does not necessarily need to be reconfigured using the **asimon** software. It is possible instead to transfer the configuration from the defective device to the replacement device using the download cable (optional accessory).

Requirements:

- A download cable must be available (see accessories in chapter 3.4).
- The replacement device must not have a valid configuration stored in its configuration memory.



Notice!

If an AS-interface safety monitor which was previously used somewhere else is now to be used as a replacement device, you must replace the existing old configuration with a new configuration which, however, you should not validate.

AS-interface safety monitor version < V2.12:

Proceed as follows:

- Disconnect the defective AS-interface safety monitor from the supply.
- Use the download cable (RJ45/RJ45) to connect the defective device to the replacement device.
- Apply the supply voltage to the replacement device.
- The configuration of the defective device is now automatically transferred to the replacement device.

Active transmission is indicated by the continuous illumination of the yellow **READY** LED. Conclusion of a successful transmission is indicated by the continuous illumination of the yellow **READY** LED and the green **ON** LED.

- Disconnect the new AS-interface safety monitor from the supply and disconnect the download cable from both devices. The replacement device can now directly be used in the place of the defective device.

AS-interface safety monitors version \geq V2.12:

Proceed as follows:

- Disconnect the defective AS-interface safety monitor from the supply and uninstall it.
- Install the new AS-interface safety monitor and connect it (connections L+, M and FE as well as AS-i+ and AS-i- as well as additional connections as necessary).
- Switch on the supply voltage for the new AS-interface safety monitor. The AS-interface safety monitor enters configuration operation.
- Connect the defective AS-interface safety monitor, which is not connected to voltage, to the new AS-interface safety monitor via the download cable (RJ45/RJ45) and press the **Service** button.
- The AS-interface safety monitor restarts (LED test) and the configuration is transferred. During transfer, the **1 READY** yellow LED illuminates.
- When the **1 READY** yellow LED goes out, transfer has concluded. Disconnect the two AS-interface safety monitors from one another and press the **Service** button again.
- The AS-interface safety monitor restarts and now operates with the transferred configuration.



Attention!

After replacing a defective AS-interface safety monitor, make certain to check the new AS-interface safety monitor for proper function.

11.6 What to do if you forget the password



Attention!

Only the responsible safety officer is permitted to retrieve a lost password in the way described below!

If you have lost the password for your configuration, proceed as follows:

1. Find the valid configuration log (printout or file) of the AS-interface safety monitor for which you no longer have a password. In the configuration log, find a four-digit code in line 10 (Monitor Section, Validated).
 - If the configuration log is unavailable and the AS-interface safety monitor is not to be switched to configuration operation, connect the AS-interface safety monitor for which you no longer have a password to the PC and start the **asimon** software.
 - Select a neutral configuration and start the diagnostic function in **asimon** with **Monitor -> Diagnose**. Now wait until the current configuration appears on the screen. This can take up to five minutes.
 - Open the **Information about monitor and bus** window (menu item **Edit -> Information about monitor and bus ...**). In the **Title** tab you will again find the four-digit code in the **Download time** window area.
2. Contact the technical support department of your supplier and state the four-digit code.
3. A **master password** can be generated from this code. This password allows you to access to the stored configuration again.
4. Use the master password to stop the AS-interface safety monitor and to enter a new user password. To do so, select **Change password...** in the **Monitor** menu of the **asimon** configuration software.



Attention!

*Please note that accessing the configuration stored in the AS-interface safety monitor can affect the reliability of the system. Changes to validated configurations should only be made by authorised personnel. All changes must be made in accordance with the instructions given in the user manual supplied with the **asimon** configuration software.*



Notice!

If no valid configuration has yet been stored in the AS-interface safety monitor, the default password "SIMON" is valid.

12 Diagnostics via AS-interface

12.1 General procedure



Notice!

*The assignment of an **AS-interface slave address for the AS-interface safety monitor** is a prerequisite for diagnosing the AS-interface safety monitor on the AS-interface master.*

Using the AS-interface bus, diagnosis of the AS-interface safety monitor and configured devices is possible from the AS-interface master, normally a PLC with master module.

However, to ensure reliable transmission and efficient evaluation of the diagnostic data, a series of requirements must be satisfied:

- Relatively long telegram propagation times may occur, particularly when using an additional bus system between PLC and AS-interface. Owing to the asynchronous transmission in the master in the case of two successive, identical data calls, the PLC may not necessarily know when the AS-interface safety monitor is responding to the new call. Thus, the answers to two successive, different data calls should differ by at least one bit.
- The diagnostic data must be consistent, i.e. the status information sent by the AS-interface safety monitor must match the actual device states, especially if the propagation time to the PLC is longer than the updating time in the AS-interface safety monitor (approx. 30 ... 150ms).
- Whether a deactivated relay of an output circuit represents the normal state depends on the operating mode of the AS-interface safety monitor. The diagnostics in the PLC should only be called in the event of a deviation from the normal state.

The diagnostic procedure described below satisfies these requirements and should therefore always be followed.

Diagnostic procedure

The PLC always queries the AS-interface safety monitor alternately with two data calls (0) and (1). These data calls return the basic information (state of the output circuits, protective/configuration operation) to allow a diagnosis. The AS-interface safety monitor answers the two calls with the same user data (3 bit, D2 ... D0). Bit D3 is a control bit, similar (but not identical) to a toggle bit. D3 is 0 for all even data calls (0); D3 is 1 for all odd data calls (1). This enables the PLC to detect whether the answer has changed.

Data calls (0) and (1) return the answer X000 if the normal state exists (protective operation, everything OK). For devices with only one output circuit and with two dependent output circuits, output circuit 2 is always marked as OK. With two independent output circuits, an unconfigured circuit is also marked as OK. In order to be able to interpret what is OK and what is not OK, the user must be familiar with his configuration.

If the data call changes from (0) to (1), the data set is stored in the AS-interface safety monitor. Bit D3 in the answer, however, remains reset until the process is concluded. As a result, the PLC thinks it has received answers to data call (0). If D3 is set, a consistent data set exists.

If, with the bit D3 set, the answer from the AS-interface safety monitor signals deactivation of an output circuit, detailed diagnostic information can now be queried in the stored state with the specific data calls (2) ... (B). Depending on the setting in the configuration of the AS-interface safety monitor, data

Diagnostics via AS-interface

calls (4) ... (B) return device diagnostic information sorted according to output circuit (see section 12.2.2) or unsorted (see section 12.2.3).



Notice!

If the AS-interface safety monitor is in configuration operation, it is not possible to query the detailed diagnostic information using the data calls (2) ... (B).

A fresh data call (0) cancels the stored state again.

12.2 Telegrams

12.2.1 Diagnosis of AS-interface safety monitor

State of output circuits, operating mode



Notice!

The alternate sending of data calls (0) and (1) is essential for consistent data transmission. see "Diagnostic procedure" on page 49.

*The **binary values of the data calls relate to the AS-interface level** and may possibly be inverted at PLC level.*

Data call / Value	Answer D3 ... D0	Meaning
(0) / 1111 State of monitor	0000	Protective operation, everything OK (unavailable, unconfigured or dependent output circuits are displayed as OK).
	0001	Protective operation, output circuit 1 off.
	0010	Protective operation, output circuit 2 off.
	0011	Protective operation, both output circuits off.
	0100	Configuration operation: Power On.
	0101	Configuration operation
	0110	Reserved / not defined
	0111	Configuration operation, fatal device error, RESET or device exchange required.
	1XXX	No up-to-date diagnostic information available, please wait.

Data call / Value	Answer D3 ... D0	Meaning
(1) / 1110 Store diagnostic information (state of monitor)	1000	Protective operation, everything OK (unavailable, unconfigured or dependent output circuits are displayed as OK).
	1001	Protective operation, output circuit 1 off.
	1010	Protective operation, output circuit 2 off.
	1011	Protective operation, both output circuits off.
	1100	Configuration operation: Power On.
	1101	Configuration operation
	1110	Reserved / not defined
	1111	Configuration operation, fatal device error, RESET or device exchange required.

State of device LEDs

Data calls (2) and (3) return a simplified indication of the output circuit LEDs (see chapter 9.2) on the AS-interface safety monitor.

If answer to data call (1) = 10XX:

Data call / Value	Answer D3 ... D0	Meaning
(2) / 1101 State of LEDs of output circuit 1	0000	Green = contacts of output circuit closed
	0001	Yellow = startup/restart-disable active
	0010	Yellow flashing or red = contacts of output circuit open
	0011	Red flashing = error on level of the monitored AS-interface components
	01XX	Reserved

Data call / Value	Answer D3 ... D0	Meaning
(3) / 1100 State of LEDs of output circuit 2	1000	Green = contacts of output circuit closed
	1001	Yellow = startup/restart-disable active
	1010	Yellow flashing or red = contacts of output circuit open
	1011	Red flashing = error on level of the monitored AS-interface components
	11XX	Reserved

Colour coding

**Notice!**

The colour of a device corresponds to the colour of the virtual LEDs in the diagnostic view of the **asimon** configuration software. A device which is not assigned to any output circuit is always shown in green.

Code CCC (D2 ... D0)	Colour	Meaning
000	green, continuous	Device is in the ON state (switched on)
001	green, flashing	Device is in the ON state (switched on), but already in the process of being switched to the OFF state, e.g. switch-off delay
010	yellow, continuous	Device is ready, but is still waiting for another condition, e.g. local acknowledgement or start button
011	yellow, flashing	Time condition exceeded, action must be repeated, e.g. synchronisation time exceeded
100	red, continuous	Device is in the OFF state (switched off)
101	red, flashing	The error lock is active, release by means of one of the following actions: <ul style="list-style-type: none">• Acknowledge with the service button• Power OFF/ON• AS-interface bus OFF/ON
110	grey, off	No communication with the AS-interface slave

Table 12.1: Colour coding

**Notice!**

During proper protective operation, there are also devices which are not in the green state. When searching for the cause of a shutdown, the device with the lowest device index is the most important. Others may just be subsequent effects (example: when the emergency shutdown button is pressed, the start device and timer are also in the OFF state).

By appropriately programming the functional component in the PLC, the user can be guided to the primary cause of the error. Detailed knowledge of the configuration and the function of the AS-interface safety monitor are necessary for the interpretation of additional information.

Because the device numbers can be shifted if the configuration is changed, we recommend using the diagnosis index assignment.

12.2.2 Diagnosis of devices, sorted according to OSSD

With the appropriate configuration setting, data calls (4) ... (B) return device diagnostic information sorted according to output circuit.



Notice!

*Make sure that the correct diagnosis type is set for the AS-interface safety monitor in the **Information about monitor and bus** window of the **asimon** configuration software.*

The values returned in calls (5) and (6) as well as (9) and (A) refer to the device diagnosis index in the configuration program and not to an AS-interface address.

Always execute data calls (4) ... (7) and (8) ... (B) together in sequence for each device.

Sorted device diagnosis, output circuit 1

If answer to data call (1) = 10X1:

Data call / Value	Answer D3 ... D0	Meaning
(4) / 1011 Number of devices not green, output circuit 1	0XXX	XXX = 0: no devices, answers to data calls (5) ... (7) not relevant XXX = 1 ... 6: number of devices in output circuit 1 XXX = 7: number of devices is > 6 in output circuit 1
(5) / 1010 Device address HIGH, output circuit 1	1HHH	HHH = I5,I4,I3: diagnosis index of device in output circuit 1 of configuration (HHHLLL = diagnosis index)
(6) / 1001 Device address LOW, output circuit 1	0LLL	LLL = I2,I1,I0: diagnosis index of device in output circuit 1 of configuration (HHHLLL = diagnosis index)
(7) / 1000 Colour of device, output circuit 1	1CCC	CCC = colour (see table 12.1 on page 52)

Sorted device diagnosis, output circuit 2

If answer to data call (1) = 101X:

Data call / Value	Answer D3 ... D0	Meaning
(8) / 0111 Number of devices not green, output circuit 2	0XXX	XXX = 0: no devices, answers to data calls (5) ... (7) not relevant XXX = 1 ... 6: number of devices in output circuit 2 XXX = 7: number of devices is > 6 in output circuit 2
Data call / Value	Answer D3 ... D0	Meaning
(9) / 0110 Device address HIGH, output circuit 2	1HHH	HHH = I5,I4,I3: diagnosis index of device in output circuit 2 of configuration (HHHLLL = diagnosis index)
Data call / Value	Answer D3 ... D0	Meaning
(A) / 0101 Device address LOW, output circuit 2	0LLL	LLL = I2,I1,I0: diagnosis index of device in output circuit 2 of configuration (HHHLLL = diagnosis index)
Data call / Value	Answer D3 ... D0	Meaning
(B) / 0100 Colour of device, output circuit 2	1CCC	CCC = colour (see table 12.1 on page 52)



Notice!

Data calls (C) 0011 to (F) 0000 are reserved.

12.2.3 Diagnosis of devices, unsorted

With the appropriate configuration setting, data calls (4) ... (B) return unsorted device diagnostic information for all devices.



Notice!

*Make sure that the correct diagnosis type is set for the AS-interface safety monitor in the **Information about monitor and bus** window of the **asimon** configuration software.*

The values returned in calls (5) and (6) as well as (9) and (A) refer to the device diagnosis index in the configuration program and not to an AS-interface address.

Always execute data calls (4) ... (7) and (8) ... (B) together in sequence for each device.

Unsorted device diagnosis, all devices

If answer to data call (1) = 1001, 1010 or 1011:

Data call / Value	Answer D3 ... D0	Meaning
(4) / 1011 Number of devices not green, continuous	0XXX	XXX = 0: no devices, answers to data calls (5) ... (7) not relevant. XXX = 1 ... 6: number of devices not green. XXX = 7: number of devices not green is > 6 (for colours, see table 12.1 on page 52).
Data call / Value	Answer D3 ... D0	Meaning
(5) / 1010 Device address HIGH	1HHH	HHH = I5,I4,I3: diagnosis index of device of configuration (HHHLLL = diagnosis index).
Data call / Value	Answer D3 ... D0	Meaning
(6) / 1001 Device address LOW	0LLL	LLL = I2,I1,I0: diagnosis index of device of configuration (HHHLLL = diagnosis index).
Data call / Value	Answer D3 ... D0	Meaning
(7) / 1000 Colour of device	1CCC	CCC = colour (see table 12.1 on page 52).
Data call / Value	Answer D3 ... D0	Meaning
(8) / 0111	0XXX	not used

Diagnostics via AS-interface

Data call / Value	Answer D3 ... D0	Meaning
(9) / 0110 Device address HIGH	1HHH	HHH = I5,I4,I3: diagnosis index of device of configuration (HHHLLL = diagnosis index).
(A) / 0101 Device address LOW	0LLL	LLL = I2,I1,I0: diagnosis index of device of configuration (HHHLLL = diagnosis index).
Data call / Value	Answer D3 ... D0	Meaning
(B) / 0100 Assignment to out- put circuit	10XX	XX = 00: device from pre-processing XX = 01: device from output circuit 1 XX = 10: device from output circuit 2 XX = 11: device from both output circuits



Notice!

Data calls (C) 0011 to (F) 0000 are reserved.

12.3 Example: Querying with diagnosis sorted according to OSSD

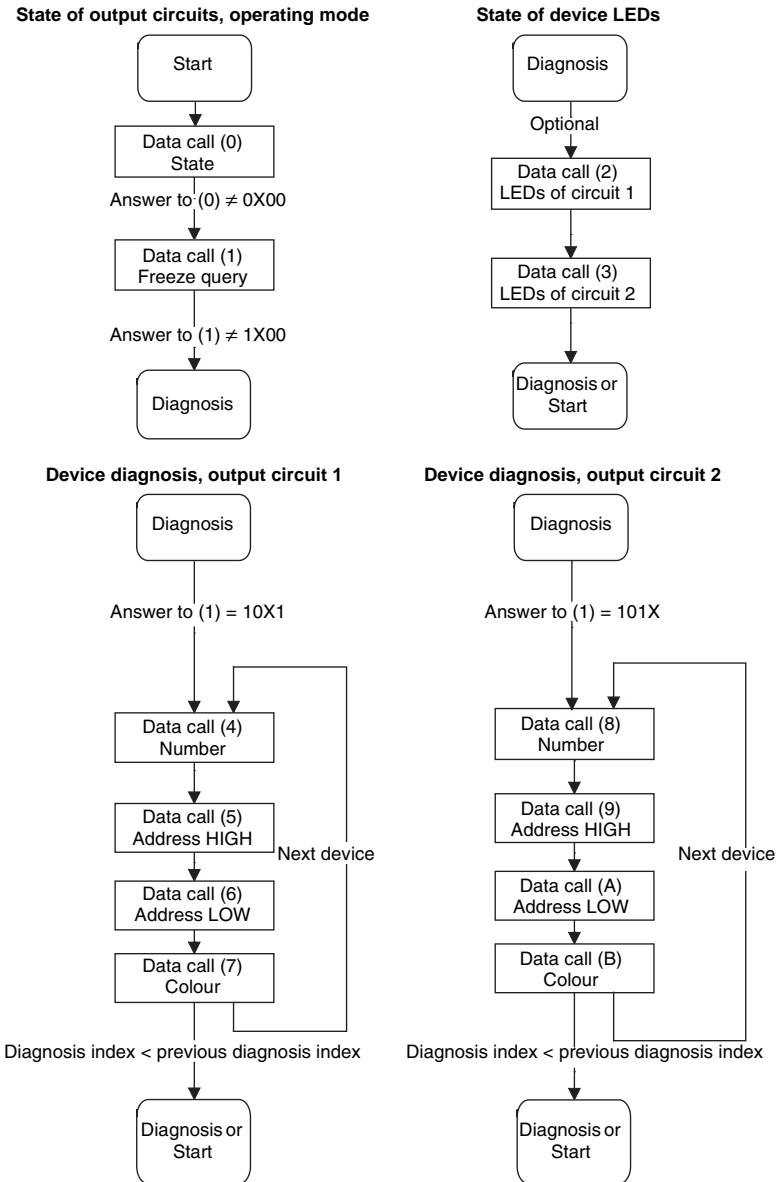

Figure 12.1: Querying with diagnosis sorted according to output circuit