

SYSTEM DESCRIPTION

H-System Isolated Barriers and Termination Boards for Emerson DeltaV



With regard to the supply of products, the current issue of the following document is applicable: The General Terms of Delivery for Products and Services of the Electrical Industry, published by the Central Association of the Electrical Industry (Zentralverband Elektrotechnik und Elektroindustrie (ZVEI) e.V.) in its most recent version as well as the supplementary clause: "Expanded reservation of proprietorship"

1	Safety	4
1.1	Instruction Manual Isolated Barriers	4
1.2	Instruction Manual Termination Boards	7
2	Product Specifications	11
2.1	Function	11
2.2	System Components	12
2.3	Connection Options	14
2.4	Color Coding of the Isolated Barriers	16
2.5	Status Indicators with LEDs	17
2.6	Status Indicators of Termination Boards	18
2.7	Label Carriers	19
3	Installation	20
3.1	DIN Mounting Rail	20
3.2	Mounting	20
3.3	Connection	24
3.4	Device Parameterization	24
4	Operation	25
4.1	Fault Monitoring	25
4.2	Fault Output	25
4.3	Current and Voltage Standard Signals	26
5	Technical Specifications	27
5.1	Technical Data	27
5.2	Model Number Description	30
5.3	Pin Assignment and Device Coding	32
5.4	Dimensions	34

1 Safety

1.1 Instruction Manual Isolated Barriers

1.1.1 Validity

Specific processes and instructions in this instruction manual require special provisions to guarantee the safety of the operating personnel.

1.1.2 Target Group, Personnel

Responsibility for planning, assembly, commissioning, operation, maintenance, and dismantling lies with the plant operator.

Mounting, installation, commissioning, operation, maintenance and disassembly of the device may only be carried out by appropriate trained and qualified personnel. The instruction manual must be read and understood.

Prior to using the device you should make yourself familiar with the device and carefully read the instruction manual.

1.1.3 Reference to Further Documentation

Observe laws, standards, and directives applicable to the intended use and the operating location.

The corresponding datasheets, declarations of conformity, EC-type-examination certificates, certificates and control drawings if applicable (see datasheet) are an integral part of this document. You can find this information under www.pepperl-fuchs.com.

Observe the instruction manuals for the respective termination boards.

1.1.4 Marking

Device identification
Pepperl+Fuchs GmbH
Lilienthalstrasse 200, 68307 Mannheim, Germany
Model number
ATEX approval
Group, category, type of protection, temperature classification

The exact designation of the device can be found on the name plate on the device side.

1.1.5 Intended Use

The device is only approved for appropriate and intended use. Ignoring these instructions will void any warranty and absolve the manufacturer from any liability.

The device is used in control and instrumentation technology (C&I technology) for the galvanic isolation of signals such as 20 mA and 10 V standard signals or alternatively for adapting or standardizing signals. The device has intrinsically safe circuits that are used for operating intrinsically safe field devices in hazardous areas.

Only use the module with the designated termination boards.

Use the device only within the specified ambient conditions.

Only use the device stationary.

The device is an associated apparatus according to IEC/EN 60079-11.

1.1.6 Improper Use

Protection of the personnel and the plant is not ensured if the device is not being used according to its intended use.

The device is not suitable for isolating signals in power installations unless this is noted separately in the corresponding datasheet.

1.1.7 Mounting and Installation

Do not mount a damaged or polluted device.

Mount the device in a way that the device is protected against mechanical hazard. Mount the device in a surrounding enclosure for example.

The device must be installed outside of the hazardous area.

Do not mount the device at locations where an aggressive atmosphere may be present.

Mount the device with at least a degree of protection of IP20 according to IEC/EN 60529.

The device must be installed and operated only in an environment that ensures a pollution degree 2 (or better) according to IEC/EN 60664-1.

If used in areas with higher pollution degree, the device needs to be protected accordingly.

All circuits connected to the device must comply with the overvoltage category II (or better) according to IEC/EN 60664-1.

Observe the installation instructions according to IEC/EN 60079-14.

Additional requirements for usage as associated apparatus

If circuits with type of protection Ex i are operated with non-intrinsically safe circuits, they must no longer be used as circuits with type of protection Ex i.

Intrinsically safe circuits of associated apparatus (installed in non-hazardous area) can be led into hazardous areas. Observe the compliance of the separation distances to all non-intrinsically safe circuits according to IEC/EN 60079-14.

Observe the compliance of the separation distances between two adjacent intrinsically safe circuits according to IEC/EN 60079-14.

Observe the maximum values of the device, when connecting the device to intrinsically safe apparatus.

If no L_o and C_o values are specified for the simultaneous appearance of lumped inductances and capacitances, the following rule applies.

- The specified value for L_o and C_o is used if one of the following conditions applies:
 - The circuit has distributed inductances and capacitances only, e. g., in cables and connection lines.
 - The total value of L_i (excluding cable) of the circuit is $< 1\%$ of the specified L_o value.
 - The total value of C_i (excluding cable) of the circuit is $< 1\%$ of the specified C_o value.
- A maximum of 50% of the specified value for L_o and C_o is used if the following condition applies:
 - The total value of L_i (excluding cable) of the circuit is $\geq 1\%$ of the specified L_o value.
 - The total value of C_i (excluding cable) of the circuit is $\geq 1\%$ of the specified C_o value.
 - The reduced capacitance for gas groups I, IIA and IIB must not exceed the value of $1\ \mu\text{F}$ (including cable).
 - The reduced capacitance for gas group IIC must not exceed the value of $600\ \text{nF}$ (including cable).

If more channels of one device are connected in parallel, ensure the parallel connection is made directly at the terminals of the device. When verifying the intrinsic safety, observe the maximum values for the parallel connection.

1.1.8 Operation, Maintenance, Repair

The devices must not be repaired, changed or manipulated. If there is a defect, the product must always be replaced with an original device.

1.1.9 Delivery, Transport, Disposal

Check the packaging and contents for damage.

Check if you have received every item and if the items received are the ones you ordered.

Keep the original packaging. Always store and transport the device in the original packaging.

Store the device in a clean and dry environment. The permitted ambient conditions (see datasheet) must be considered.

Disposing of device, packaging, and possibly contained batteries must be in compliance with the applicable laws and guidelines of the respective country.

1.2 Instruction Manual Termination Boards

1.2.1 Validity

Specific processes and instructions in this instruction manual require special provisions to guarantee the safety of the operating personnel.

1.2.2 Target Group, Personnel

Responsibility for planning, assembly, commissioning, operation, maintenance, and dismantling lies with the plant operator.

Mounting, installation, commissioning, operation, maintenance and disassembly of the device may only be carried out by appropriate trained and qualified personnel. The instruction manual must be read and understood.

Prior to using the device you should make yourself familiar with the device and carefully read the instruction manual.

1.2.3 Reference to Further Documentation

Observe laws, standards, and directives applicable to the intended use and the operating location.

The corresponding datasheets, declarations of conformity, EC-type-examination certificates, certificates and control drawings if applicable (see datasheet) are an integral part of this document. You can find this information under www.pepperl-fuchs.com.

Observe the instruction manuals for the respective modules.

1.2.4

Marking

Device identification
Pepperl+Fuchs GmbH
Lilienthalstrasse 200, 68307 Mannheim, Germany
Model number
ATEX approval
Group, category, type of protection, temperature classification

The exact designation of the device can be found on the name plate on the device side.

1.2.5

Intended Use

The device is only approved for appropriate and intended use. Ignoring these instructions will void any warranty and absolve the manufacturer from any liability.

The device is used in instrumentation and control technology (I&C technology). The device is used for the galvanic isolation of intrinsically safe circuits and non-intrinsically safe circuits. The device is used as interface between modules, field circuits and control circuits.

Only use the termination board with the designated modules.

Use the device only within the specified ambient conditions.

Only use the device stationary.

The device is an associated apparatus according to IEC/EN 60079-11.

1.2.6

Improper Use

Protection of the personnel and the plant is not ensured if the device is not being used according to its intended use.

The device is not suitable for isolating signals in power installations unless this is noted separately in the corresponding datasheet.

1.2.7 Mounting and Installation

Do not mount a damaged or polluted device.

Mount the device in a way that the device is protected against mechanical hazard. Mount the device in a surrounding enclosure for example.

The device must be installed outside of the hazardous area.

Do not mount the device at locations where an aggressive atmosphere may be present.

Mount the device with at least a degree of protection of IP20 according to IEC/EN 60529.

The device must be installed and operated only in an environment that ensures a pollution degree 2 (or better) according to IEC/EN 60664-1.

If used in areas with higher pollution degree, the device needs to be protected accordingly.

All circuits connected to the device must comply with the overvoltage category II (or better) according to IEC/EN 60664-1.

Observe the installation instructions according to IEC/EN 60079-14.

Observe the corresponding documentation or the information on the device for the correct assignment of the terminals to the modules and their respective channels.

Additional Requirements for Cables and Connection Lines

Observe the following points when installing cables and connection lines:

Observe the permissible core cross-section of the conductor.

If you use stranded conductors, crimp on wire end ferrules.

Use only one conductor per terminal.

When installing the conductors the insulation must reach up to the terminal.

Observe the tightening torque of the terminal screws.

Additional requirements for usage as associated apparatus

If circuits with type of protection Ex i are operated with non-intrinsically safe circuits, they must no longer be used as circuits with type of protection Ex i.

Intrinsically safe circuits of associated apparatus (installed in non-hazardous area) can be led into hazardous areas. Observe the compliance of the separation distances to all non-intrinsically safe circuits according to IEC/EN 60079-14.

Observe the compliance of the separation distances between two adjacent intrinsically safe circuits according to IEC/EN 60079-14.

The intrinsically safe circuits are provided by the connected modules.

Observe the maximum values of the device, when connecting the device to intrinsically safe apparatus.

If more channels of one device are connected in parallel, ensure the parallel connection is made directly at the terminals of the device. When verifying the intrinsic safety, observe the maximum values for the parallel connection.

1.2.8 Operation, Maintenance, Repair

The devices must not be repaired, changed or manipulated. If there is a defect, the product must always be replaced with an original device.

1.2.9 Delivery, Transport, Disposal

Check the packaging and contents for damage.

Check if you have received every item and if the items received are the ones you ordered.

Keep the original packaging. Always store and transport the device in the original packaging.

Store the device in a clean and dry environment. The permitted ambient conditions (see datasheet) must be considered.

Disposing of device, packaging, and possibly contained batteries must be in compliance with the applicable laws and guidelines of the respective country.

2 Product Specifications

2.1 Function

Isolated barriers are used to protect intrinsically safe circuits in explosive areas. In addition to the required current and voltage limitation, the isolated barriers have a galvanic isolation between the field circuit and the controller.

The H-System isolated barriers are mounted on Termination Boards. Pre-wiring is possible on Termination Boards. To close the signal circuit, the isolated barriers are simply plugged in. The isolated barriers can be replaced during live operation when the wiring is connected.



Figure 2.1 H-System Termination Board with isolated barriers for Emerson DeltaV

Universal and control system-specific Termination Boards are available in the H-System. Termination Boards can be adapted to specific input/output requirements. These requirements can be implemented via

- Various connecting plugs to the controller
- Various terminals to the field device
- A large selection of isolated barriers

2.2 System Components

2.2.1 Isolated Barriers

HiD isolated barriers are mounted on HiD Termination Boards.

The board can be coded together with the isolated barriers. This prevents the isolated barriers being mixed up on the Termination Board. The safety-relevant data for the connected field devices is backed up.

HiD Device Housing

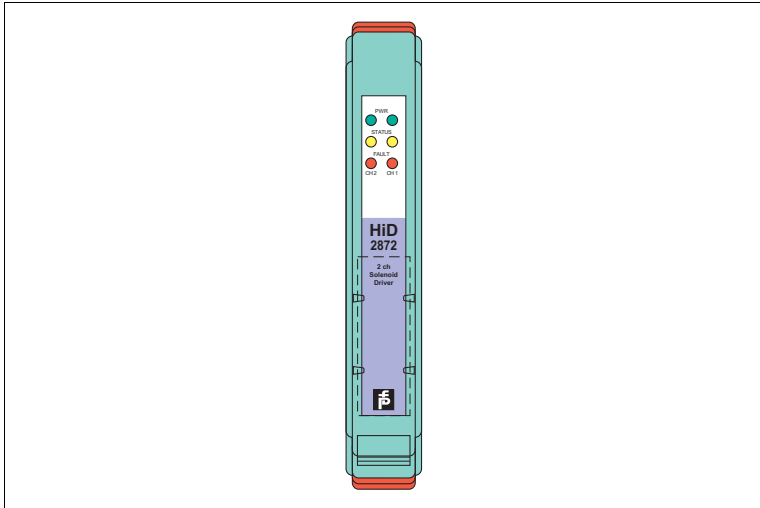

Figure 2.2 HiD device housing (18 mm)

Used for high channel density

- Compact 18 mm housing
- Highest channel density on the market
- Only 4.5 mm per channel (for 4-channel devices)
- For mounting on HiD Termination Boards

2.2.2 Termination Boards

Termination Boards form the wiring level for field and control signals. The isolated barriers are mounted on Termination Boards. The isolated barriers are connected with the field and control side via the Termination Boards. Once the isolated barrier is mounted, the signal circuit between the field and control side is closed.

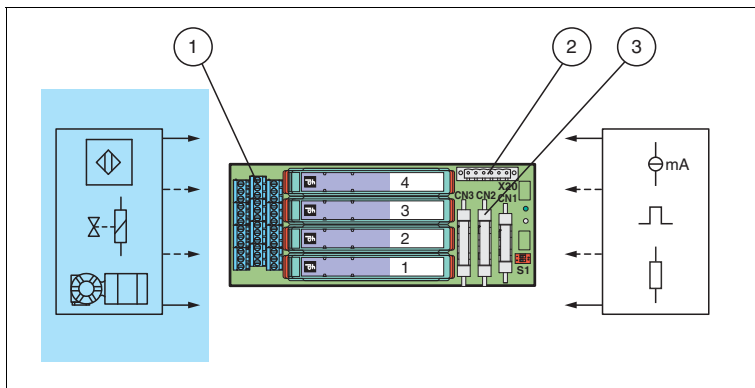

Figure 2.3 Connection example Termination Board with 4 slots

- 1 Field side connection
- 2 Connection power supply and fault indication output
- 3 Control side connection

Use

- For HiD isolated barriers
- With 4 or 8 slots
- For back-up fused power supply
- For fault monitoring and diagnostics

2.3 Connection Options

A variety of Termination Boards is available with different methods of connecting to the field and control side. Please refer to the documentation for the respective device for the specific connection layout.

Connecting the Field Side

The field devices can be connected to the Termination Board via screw terminals:

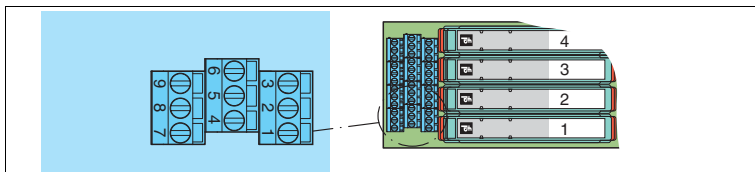

Figure 2.4 Screw terminals, three-row

Connecting the Power Supply and Fault Indication Output Isolated Barriers

The isolated barriers are supplied via the Termination Board. The isolated barriers are therefore attached to the Termination Board.

Termination Boards

The Termination Boards are supplied with power via screw terminals in accordance with their design.

The supply voltage range depends on

- The values used for the isolated barriers
- The voltage drop of the decoupling diodes on the Termination Board

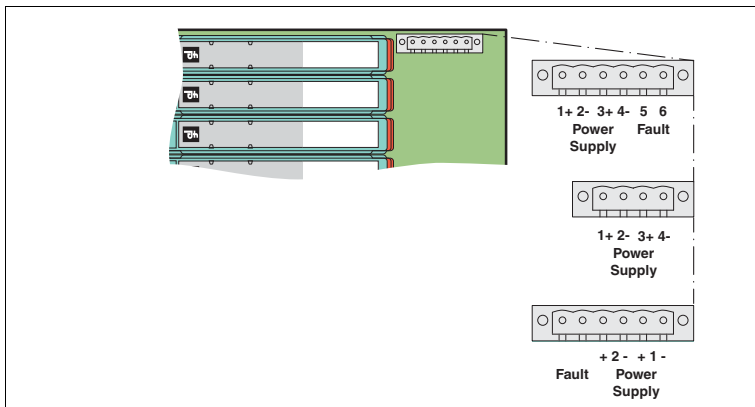

Figure 2.5 Possible connections of power supply and fault indication output via screw terminals

Connecting the Control Side

The Termination Board on the control side can be connected via IDC connectors:

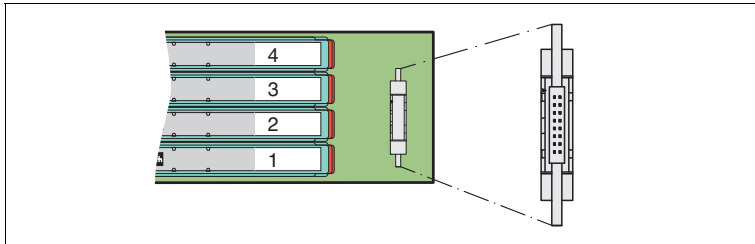

Figure 2.6 Connection via IDC connector, 16-pin

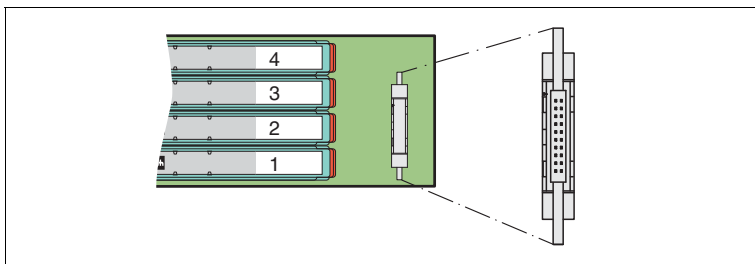

Figure 2.7 Connection via IDC connector, 20-pin

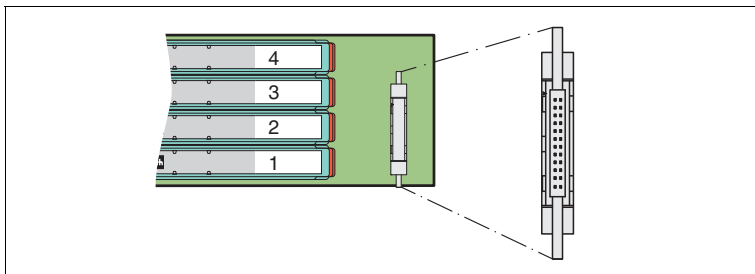

Figure 2.8 Connection via IDC connector, 24-pin



Note!

For more information see the corresponding data sheets.

2.4 Color Coding of the Isolated Barriers

The color coding of the devices has the following meaning:

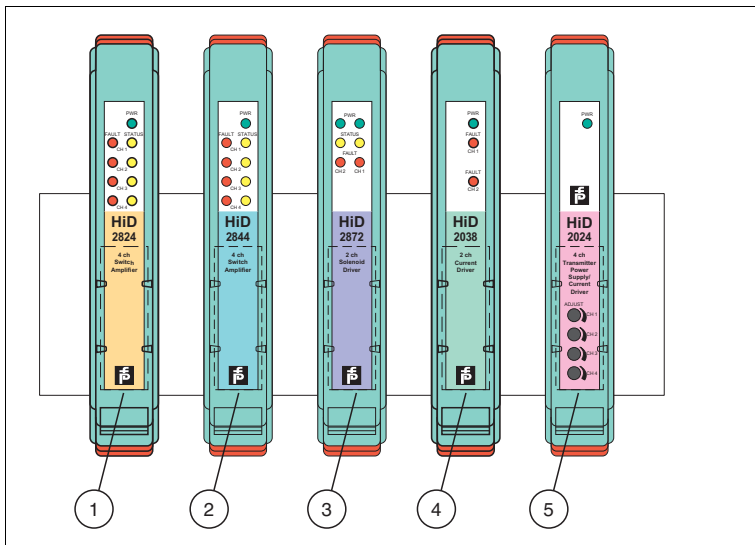

Figure 2.9 Color identification of devices

Digital Input

- Orange identifier (1) for switch amplifiers with a relay output
- Blue identifier (2) for switch amplifiers with a transistor output

Digital Output

- Purple identifier (3) for solenoid drivers

Analog Output

- Green identifier (4) for current drivers

Analog Input/Analog Output

- Magenta identifier (5) for transmitter power supplies, measuring transmitters, and repeaters

2.5 Status Indicators with LEDs

LEDs are often used on isolators to indicate different statuses (e. g. for power supply, device failure, status messages, binary switching states). Standard LED colors are assigned to the status display according to NAMUR NE44.

LED	Display function	Display	Meaning
Green LED	Power supply	On	Power supply OK
		Off	Power failure or insufficient power supply – device faulty
Red LED	Device fault, device failure	On	Internal fault signal, failure signal – fault/failure display of causes detected inside the device, device needs replacing
	Line fault	Flashing	External fault signal, failure signal – fault/failure display of causes detected outside the device, inspection and elimination of fault required
	No fault	Off	No malfunction, device is operating properly
Yellow LED	Switching states of binary inputs and outputs	On	Possible causes of the output: <ul style="list-style-type: none"> • The relay is energized. • The NO contact (also a change-over contact) is actively closed. • The open collector is switched through. • The switching voltage generated inside the device is applied. Possible causes of the input: <ul style="list-style-type: none"> • An external contact is closed. • A NAMUR sensor is undamped (OK range according to closed-circuit current principle). • A switching signal is actively applied.
		Off	Possible causes of the output: <ul style="list-style-type: none"> • The relay is de-energized. • The NO contact (also a change-over contact) is actively opened. • The open collector is not switched through. • The switching voltage generated inside the device is not applied. Possible causes of the input: <ul style="list-style-type: none"> • An external contact is opened. • A NAMUR sensor is damped (fault range according to closed-circuit current principle). • A switching signal is not applied.

Table 2.1 Meaning of status indicators



Figure 2.10 Example status indicators

- 1 Yellow LED "OUT"
Switching state of the output
- 2 Red LED "CHK"
Lead breakage and short circuit status indicator
- 3 Green LED "PWR"
Power supply status indicator

2.6 Status Indicators of Termination Boards

LEDs are often used on Termination Boards to indicate different statuses (e. g. for power supply, device failure, status messages, binary switching states). Standard LED colors are assigned to the status display according to NAMUR NE44.

LED	Display function	Display	Meaning
Green LED "PWR"	Power supply	On	Power supply OK
		Off	No power
Red LED "FAULT"	Device fault, device failure	On	Internal fault signal, failure signal – fault/failure display of causes detected inside the device
		Off	No fault
	Power supply failure ^a	Flashing	Insufficient power supply or power supply failure

Table 2.2 Meaning of status indicators

^a only for Termination Board with 8 slots

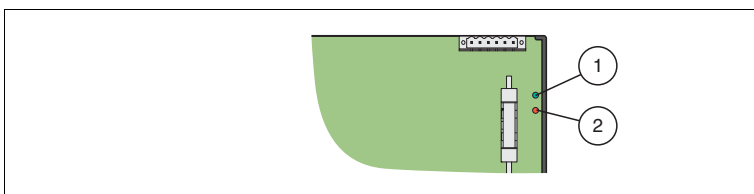

Figure 2.11 Example status indicators

- 1 Green LED "PWR" Status indicator power supply
- 2 Red LED "FAULT" Device fault, device failure, power supply failure

2.7 Label Carriers

The isolated barriers are fitted with a label carrier ex works for individual identification.

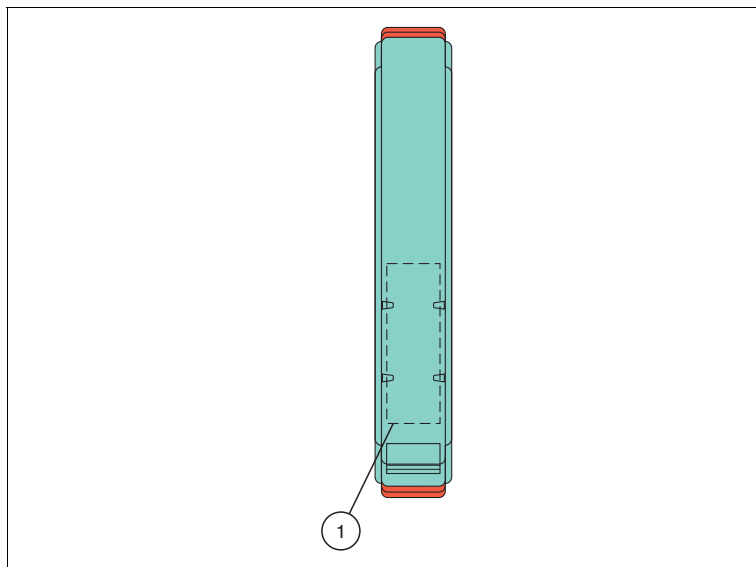

Figure 2.12 Label carrier on the front

- 1 Label carrier on HiD devices for 35 mm x 10.5 mm labels

3 Installation

3.1 DIN Mounting Rail

The devices are mounted on a 35 mm DIN mounting rail according to EN 60715.

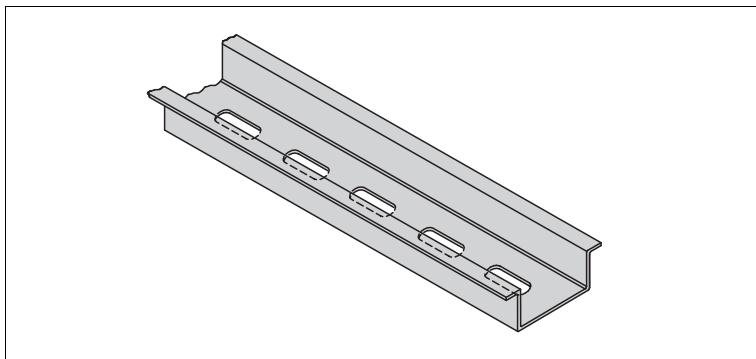

Figure 3.1 Example: DIN mounting rail UPR-MR (35 mm x 15 mm)

3.2 Mounting



Warning!

Risk of short circuit

Injuries and damage to the device are possible when working with live parts.

- Before working on the device, always disconnect the supply voltage.
- Connect the device to the supply voltage only after completion of the work.



Mounting the Termination Boards

The Termination Boards are mounted on the 35 mm DIN mounting rail. The DIN mounting rail runs centrally below the Termination Board.

1. Clip the Termination Board (2) onto the DIN mounting rail (1).
2. Tighten the mounting screws (3).

↳ The Termination Board (2) is now properly mounted and secured.

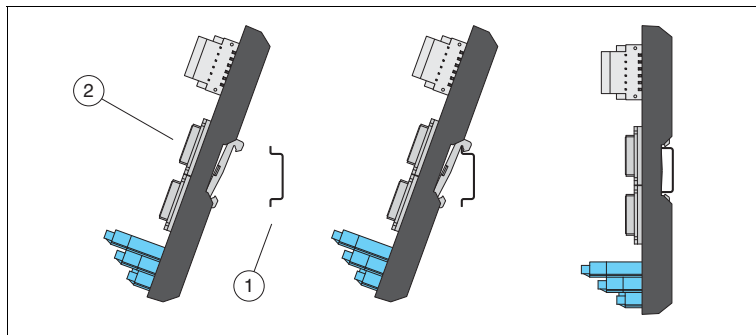

Figure 3.2 Termination Board mounting

- 1 DIN mounting rail
- 2 Termination Board

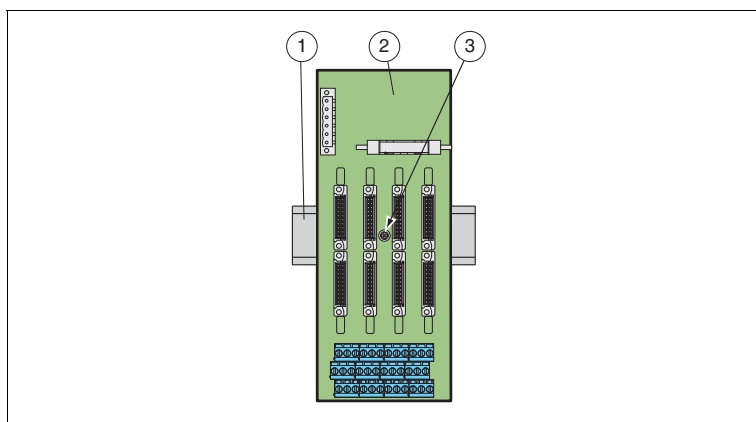

Figure 3.3 Termination Board fixing

- 1 DIN mounting rail
- 2 Termination Board
- 3 Fastening screw

Vertical and Horizontal Mounting

Both mounting options are possible. Unrestricted operation is possible across the entire temperature range of the system in each mounting direction.

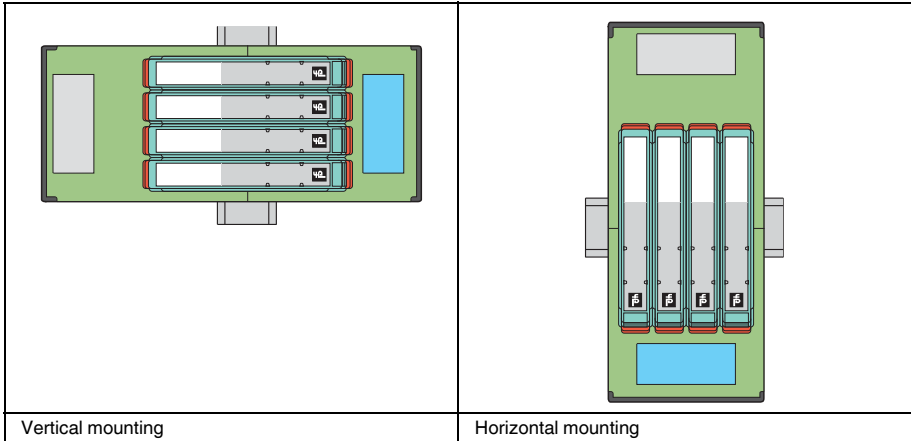

Figure 3.4



Mounting the Isolated Barriers on the Termination Board

1. Push the Quick Lok bar (1) into the upper position.
2. Center the pins (2) above the contact elements of the Termination Board. Note the connection direction of the device.
3. Center the locking pins (3) above the locking elements of the Termination Board.
4. Carefully push the device into the contacts and locking elements.
5. Push the red Quick Lok bar (1) down on either side of the device.

↳ The device is now mounted.

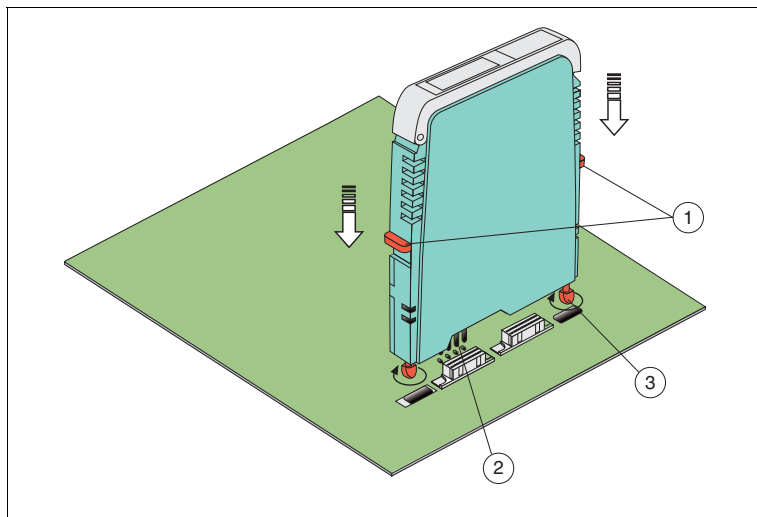

Figure 3.5 Mounting of an H-System isolated barrier

- 1 Quick Lok Bar
- 2 Coding pins
- 3 Adjustment pins

3.3 Connection



Note!

Observe the tightening torque of the terminal screws. The tightening torque is 0.5 Nm to 0.6 Nm.

Connecting the Field Side

Connect the field devices to the Termination Board via the screw terminals.

Connecting the Power Supply and Fault Indication Output

Connect the power supply and fault indication output via the screw terminals.

Connecting the Control Side

Connect the Termination Board on the control side via the IDC connectors.



Note!

For more information see the corresponding data sheets.

3.4 Device Parameterization

The devices are parameterized using DIP switches.



Configuration of the isolated barriers

Parameterize the DIP switches on the device side as follows:

1. Remove the isolated barriers from the Termination Board by pulling the red Quick Lok Bar up on either side of the device.
2. Parameterize the DIP switches as described in the "Configuration" section of the data sheet.
3. Mount the device as described in the section on mounting.



Note!

For more information see the corresponding data sheets.

4 Operation

4.1 Fault Monitoring

Numerous faults can occur between measurement of the process variable and evaluation in the control system. This can lead to undesirable process statuses under certain circumstances. These process statuses may result in plant downtime or quality problems or even present a hazard to persons and the environment. Depending on the device version, the isolators enable monitoring of the following faults:

- Line faults
Here, the connection cables between the isolator and field device are monitored for lead breakages or short circuits. If a fault is detected, it is output at the fault message output or collective fault message. The relevant switching outputs are then switched to a de-energized state. The red fault indication LEDs signal the fault.
- Device faults
The isolators are designed so that internal faults are detected and reported. In the case of a power failure, the outputs are switched to a de-energized state.

4.2 Fault Output

Several H-System isolators monitor the field leads for lead breakage and short circuits. This means that faults are immediately identified in the system, and that lead faults are not interpreted as a signal. Depending on the parameterization of the devices, these lead faults are output on the control-side outputs.

Fault Signal Output

If the device has a fault indication output (FAULT), lead and device faults are output. The fault indication output is active in normal status and is deactivated in fault status (closed-circuit principle). In the case of fault indication output, it is not possible to reverse the direction of operation.

Information about line fault detection of the interface modules is available for the system as volt-free contact.

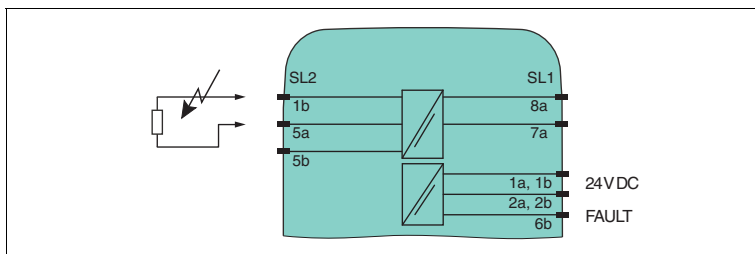

Figure 4.1

Line Fault Transparency (LFT)

If the device has a signal output with line fault transparency, the fault message can be transmitted on the signal lead. This saves additional wiring and delivers channel-selective fault messages.

4.3 Current and Voltage Standard Signals

The following signals have established themselves as the standard:

- the 0/4 mA to 20 mA current signal
- the 0/2 V to 10 V voltage signal

The 0/1 V to 5 V voltage signal is also occasionally encountered in addition to the 0/2 V to 10 V voltage signal.

Analog sensor signals and digital frequency signals are converted into one of the two standard signals for processing in a wide variety of measurement, regulatory and control tasks. This offers the measurement and control technician an easy-to-measure standard signal common to all manufacturers. Sensor signals are converted into standard signals via signal converters.

For more diagnostic options, the NAMUR organization published NAMUR recommendation NE43, dividing the value range of the signal (e. g. current signal) into several areas. Valid, defined measurement value information is transferred within the range from 3.8 mA to 20.5 mA. Failure information is available when the signal current is < 3.6 mA or > 21 mA i. e. outside of the range for measured value information. The same applies to the voltage signal.

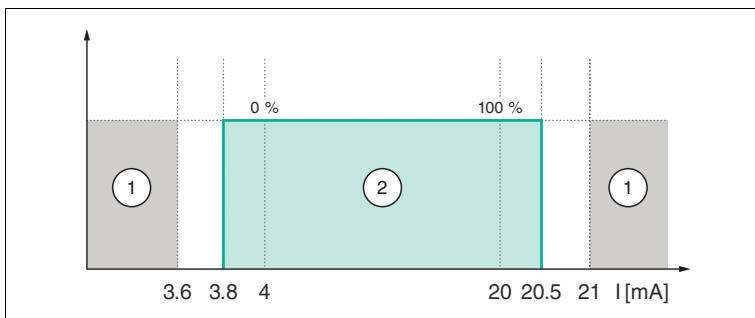

Figure 4.2 Signal ranges according to NAMUR NE43 (e. g. current signal)

- 1 Failure information
- 2 Measuring information

5 Technical Specifications

5.1 Technical Data

Electrical Data

Power Supply to the Isolated Barriers

- HiD devices: 20.4 V DC to 30 V DC

The voltage drop on the Termination Board via the decoupling diodes must be considered.

Non-Ex Signals or Signals in the Control Circuit

- 0/4 mA to 20 mA signal level according to NE43
- Current output HART compatible
- Current input HART compatible
- Digital output: active or passive electronic output 100 mA/30 V, short-circuit protected
- Logic level 24 V according to IEC 60946
- Functional isolation or safe isolation according to IEC 61140 and NAMUR NE23

Ex Signals or Signals in the Field Circuit

- Transmitter power supply up to 17 V DC
- Current output HART compatible
- Digital input according to NAMUR EN 60947-5-6
- Digital output for standard Ex-i valves, short circuit-protected

Characteristic Safety Values

- MTBF: Mean Time Between Failures

Conformity

General

- Isolated barriers with explosion protection, preferably Ex ia IIC/Class I, Div. 1, international approvals
- EMV according to
 - EN 61326-1
 - EN 61326-3-2, only for devices with SIL rating, where the data sheet mentions this standard.
If you operate the device with a DC supply voltage, you must ensure that the bridging of the 20 ms voltage interruption is realized by the power supply.
 - NAMUR NE21
If you operate the device with a DC supply voltage, you must ensure that the bridging of the 20 ms voltage interruption is realized by the power supply.
- LEDs according to NAMUR NE44
- Software according to NAMUR NE53

Digital Inputs and Outputs according to NAMUR

The standards references for this interface have changed many times:

- German standard (old): **DIN 19234**: Electrical distance sensors – DC interface for distance sensors and switch amplifiers; 1990-06
- European standard (old): **EN 50227**: Low voltage switch gear and control gear – control devices and switching elements – proximity switches, DC interface for proximity sensors and switch amplifiers (NAMUR), 1996-10
- German version (old): **DIN EN 50227**: Low voltage switch gear – control devices and switching elements – proximity switches, DC interface for proximity sensors and switch amplifiers (NAMUR), 1997
- **Current designation: EN 60947-5-6**: Low voltage switch gear – control devices and switching elements – proximity switches, DC interface for proximity sensors and switch amplifiers (NAMUR), 2000
- **Current IEC designation: IEC 60947-5-6**: Low voltage switch gear and control gear – part 5-6: Control devices and switching elements – DC interface for proximity sensors and switch amplifiers (NAMUR), 1999

Ambient Conditions

Ambient Temperature

- -20 °C to 60 °C (-4 °F to 140 °F), exceptions see data sheets

Storage Temperature

- -40 °C to 70 °C (-40 °F to 158 °F), exceptions see data sheets

Reference Conditions for Adjustment

- 20 °C (68 °F)

Relative Humidity

- max. 95 % without moisture condensation

Vibration Resistance

- according to EN 60068-2-6, 10 Hz to 150 Hz, 1 g, high crossover frequency

Shock Resistance

- according to EN 60068-2-27, 15 g, 11 ms, half-sine

Mechanical Data

Mounting

- Termination Boards: Snap-on 35 mm DIN mounting rail according to EN 60715. Can be mounted horizontally or vertically.
- Isolated barriers: mounting on Termination Board via Quick Lok Bar

Housing Material

- Termination Boards: Polycarbonate (PC)
- Isolated barriers: Polycarbonate (PC)

Dimensions

- Dimension drawings please refer to chapter Dimensions.

Degree of Protection

- Termination Boards:
 - without isolated barriers IP00 according to EN 60529
 - with isolated barriers plugged IP20 according to EN 60529
- Isolated barriers: IP20 according to EN 60529

Connection to Termination Board

- Field side:
 - Screw terminals, three-row:
0.2 ... 2.5 mm² (22 ... 12 AWG)
- Power supply and fault indication output:
 - Screw terminals: max. 1 x 2.5 mm² (12 AWG)
 - Observe the tightening torque of the terminal screws. The tightening torque is 0.5 Nm to 0.6 Nm.
- Control side:
 - IDC connector, 16-pin
 - IDC connector, 20-pin
 - IDC connector, 24-pin

Fire Protection Class

- Housing: V2 according to UL 94 standard. Unless stated otherwise all details relate to the reference conditions.



Note!

For more information see the corresponding data sheets.

5.2

Model Number Description

Model Number Description Isolated Barriers

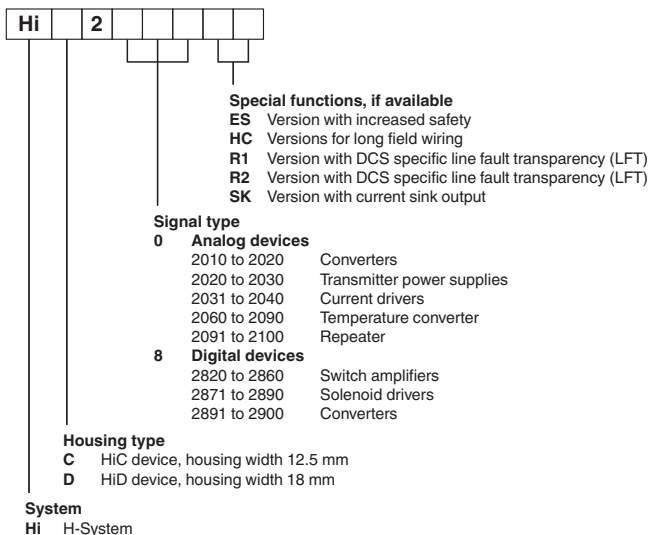

Model Number description Termination Boards

HiDTB	-	DVM	-	IDC	-	-	-		
-------	---	-----	---	-----	---	---	---	--	--

Number of channels

- 08** 8 channels
- 16** 16 channels
- 32** 32 channels

Signal types

- AI** Analog In
- AO** Analog Out
- AM** Analog Mix
- DI** Digital In
- DO** Digital Out
- DM** Digital Mix
- SM** Signal Mix

Termination Board fault output

- NO** No fault output
- R1** 1 relay output
- R2** 2 relay outputs

Field side connection

- SC** Screw terminals
- SP** Spring terminals

Number of connectors

- 1** 1 connector
- 2** 2 connectors
- 3** 3 connectors
- 4** 4 connectors

Control side connection

- IDC** IDC connector

Product family name

- DVM** Emerson DeltaV M-Series and S-Series

Number of positions

- 04** 4 module slots
- 08** 8 module slots

System
HiDTB

H-System Termination Board

5.3 Pin Assignment and Device Coding

The isolated barriers are coded in accordance with their function.



Warning!







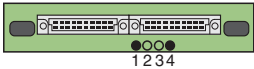
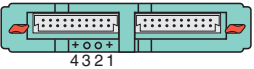
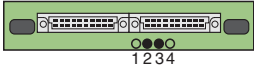
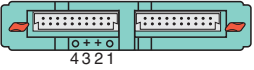
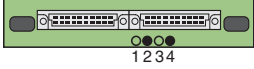

Possible Device Failure

Changes in the pin configuration may lead to device failure. To polarize the device in accordance with its safety parameters, the pins are shortened at the factory.

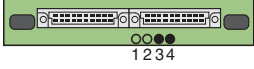
- Do not change the factory setting!

Device Coding of HiD Devices and HiD Termination Boards

No.	Termination Board Top view		Isolated barrier Bottom view		Type
	Safe area	Hazardous area	Hazardous area	Safe area	
A					HiD2000 all non-intrinsically safe devices
B					-
C					HiD2096
D					-
E					HiD2881
F					HiD2061, HiD2062, HiD2071, HiD2072, HiD2821, HiD2822, HiD2824, HiD2842, HiD2844
G					HiD2024, HiD2025, HiD2025SK, HiD2026, HiD2026SK, HiD2029, HiD2029SK, HiD2030, HiD2030SK, HiD2031, HiD2032, HiD2033, HiD2034, HiD2035, HiD2036, HiD2037, HiD2038, HiD2038Y, HiD2875, HiD2876, HiD2877, HiD2878

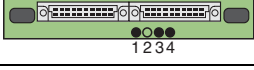
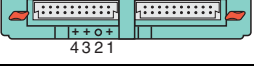
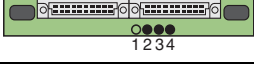
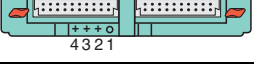
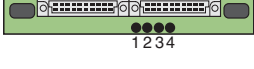
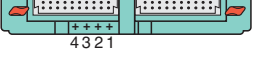
No.	Termination Board Top view		Isolated barrier Bottom view		Type
	Safe area	Hazardous area	Hazardous area	Safe area	
H					HiD2871, HiD2872, HiD2873, HiD2874
I					-
J					HiD2081, HiD2082
K					HiD2025ES, HiD2031ES
L					HiD2012
M					HiD2891
N					-
O					-
P					HiD2862 Empty position

No.	Termination Board Top view		Isolated barrier Bottom view		Type
	Safe area	Hazardous area	Hazardous area	Safe area	
	<ul style="list-style-type: none"> ● Insert polarizing pin ○ Don't insert polarizing pin 		<ul style="list-style-type: none"> + Pin to be trimmed ○ Pin untrimmed <p>Device side view</p> 		

Table 5.1



Note!

For more information see the corresponding data sheets.

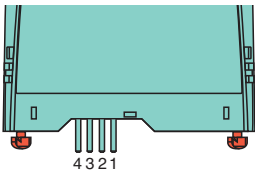
5.4 Dimensions

5.4.1 Housing Designs for H-System HiD Isolated Barriers

HiD device housings

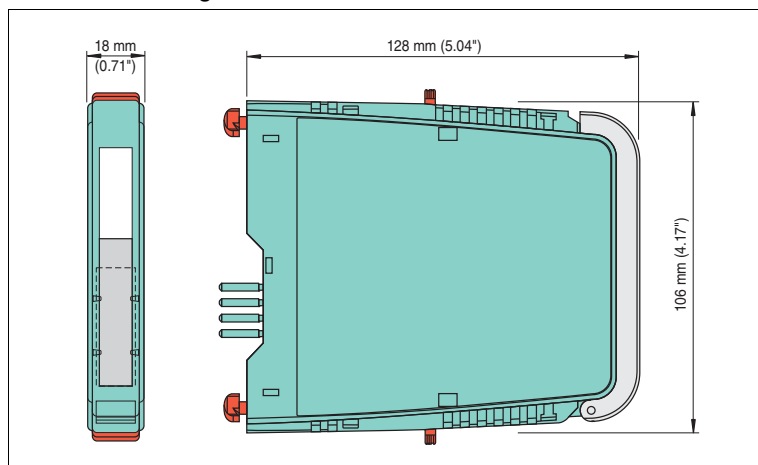

Figure 5.1

5.4.2 Housing Types Termination Boards

HiD Termination Board for 4 Modules

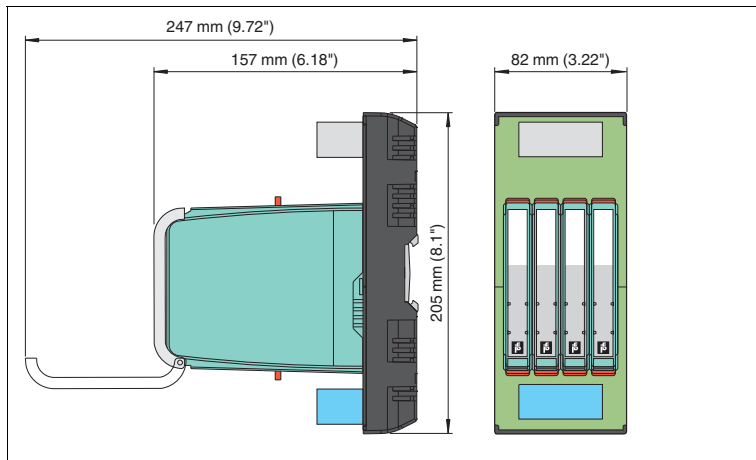

Figure 5.2

HiD Termination Board for 8 Modules

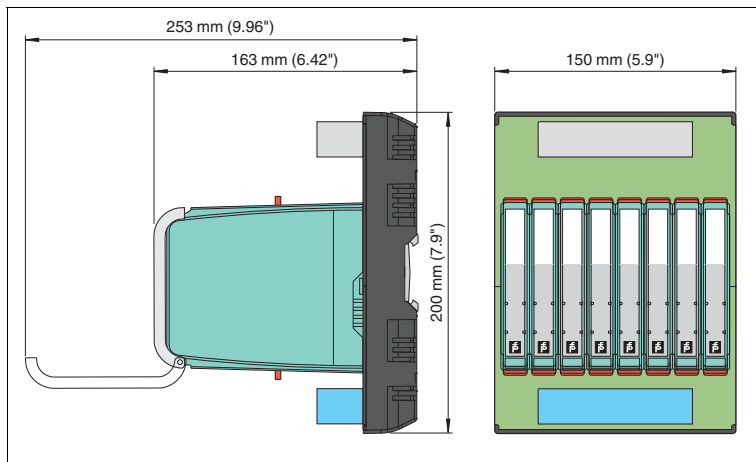

Figure 5.3

PROCESS AUTOMATION – PROTECTING YOUR PROCESS



Worldwide Headquarters

Pepperl+Fuchs GmbH
68307 Mannheim · Germany
Tel. +49 621 776-0
E-mail: info@de.pepperl-fuchs.com

For the Pepperl+Fuchs representative
closest to you check www.pepperl-fuchs.com/contact

www.pepperl-fuchs.com

Subject to modifications
Copyright PEPPERL+FUCHS • Printed in Germany

 **PEPPERL+FUCHS**
PROTECTING YOUR PROCESS

DOCT-3660A
05/2015